

## Reviews

**Structure, biosynthesis and functions of glycoprotein glycans**

Eric G. Berger

*Medizinisch-Chemisches Institut der Universität Bern, CH-3000 Bern 9 (Switzerland)*

Eckhart Buddecke

*Institut für Physiologische Chemie der Universität Münster, D-4400 Münster (Federal Republic of Germany)*

Johannis P. Kamerling

*Department of Bio-Organic Chemistry, State University of Utrecht, NL-3522 AD Utrecht (The Netherlands)*

Akira Kobata

*Department of Biochemistry, Kobe University School of Medicine, Chuo-ku, Kobe (Japan)*

James C. Paulson

*Department of Biological Chemistry, UCLA School of Medicine, Los Angeles (CA 90024, USA)*

Johannes F. G. Vliegthart

*Department of Bio-Organic Chemistry, State University of Utrecht, NL-3522 AD Utrecht (The Netherlands)*

Since the pioneering work on structure and function of heteroglycans compiled in the classical books edited by A. Gottschalk in 1972<sup>1</sup>, there have been several promising developments in glycoconjugate research, as reviewed in this article.

In Part 1, contributed by A. Kobata, current knowledge on heteroglycan structures is presented and representative examples taken from higher organisms are given. Part 2, written by J. F. G. Vliegthart and J. P. Kamerling, covers the most important achievements in methodology: procedures to obtain pure glycans and to analyze their structures. Part 3, contributed by J. Paulson, is devoted to biosynthesis of glycans now describable as pathways since several of the glycosyltransferases have been isolated and analyzed for specificity. In Part 4, contributed by E. Buddecke, current knowledge on functional roles of glycans is presented.

It will become apparent that the prerequisite for valid work either in biosynthetic or functional context depends on solid structural information. This is particularly true whenever glycosyltransferase reaction products are being analyzed, or glycans involved in biological functions are investigated. Although in past years, a great deal of important knowledge has been gathered by use of crude glycosidase or glycosyltransferase activities (a notable example is found in reference 2), one may now postulate that glycans implicated in biological reactions should be thoroughly analyzed.

This review may familiarize 'newcomers' with the field of glycoconjugate research with special emphasis on glycoprotein glycans. Glycolipids are not included in this article as they have recently been reviewed by S. I. Hakomori<sup>3</sup>. The reader is also referred to several excellent monographs<sup>4,5</sup> and the Proceedings of the Glycoconjugate Symposia held biannually<sup>6-8</sup>.

## Part 1

**The structure of the sugar moieties of glycoproteins**

In order to elucidate the molecular basis of the biological phenomena in which glycans are involved, information as to the exact structure of the relevant glycoconjugates, especially the sugar chain moieties are indispensable. Glycoproteins usually contain multiple sugar chains with different structures. Exhaustive pronase digestion of glycoproteins and analysis of the isolated glycopeptides has been the method used to generate carbohydrate moieties for structural analy-

sis<sup>9</sup>. This routine method unfortunately often leads to false conclusions of sugar chain structures because of the structural diversity of the peptide moieties produced. The establishment of enzymatic<sup>10</sup> and chemical<sup>9,11,12</sup> methods to release the sugar chains from the polypeptide backbone has opened a new age in the structural study of glycoproteins.

The sugar chains of glycoproteins can be classified

---

We are grateful to Dr Eric G. Berger for his invaluable assistance in conceiving the basic outline for the present review, and for amalgamating the individual contributions into a well-integrated survey.





chains with either Gal $\beta$ 1  $\rightarrow$  4GlcNAc or NeuAca2  $\rightarrow$  6Gal $\beta$ 1  $\rightarrow$  4GlcNAc outer chain residue<sup>26</sup>. In contrast, the oligosaccharide units isolated from fibronectin derived from bovine plasma are more diverse. These biantennary complex type sugar chains contain 4 different outer chain moieties: Gal $\beta$ 1  $\rightarrow$  4GlcNAc, NeuAca2  $\rightarrow$  6Gal $\beta$ 1  $\rightarrow$  4GlcNAc, NeuAca2  $\rightarrow$  4Gal $\beta$ 1  $\rightarrow$  4GlcNAc and NeuAca2  $\rightarrow$  3-Gal $\beta$ 1  $\rightarrow$  3(NeuAca2  $\rightarrow$  6)GlcNAc<sup>27</sup>.

The complex type sugar chains of  $\alpha_1$ -acid glycoprotein derived from rat and human plasma also show structural disparity<sup>28</sup>. In this case, however, the structural differences include core variations as well as outer chain disparity. Approximately 80% of the rat sugar chains are biantennary while more than 90% of the human sugar chains have been found to be tri- and tetraantennary. A mixture of Mana1  $\rightarrow$  6(Mana1  $\rightarrow$  3)-Man $\beta$ 1  $\rightarrow$  4GlcNAc $\beta$ 1  $\rightarrow$  4(Fuca1  $\rightarrow$  6)GlcNAc and Mana1  $\rightarrow$  6(Mana1  $\rightarrow$  3)Man $\beta$ 1  $\rightarrow$  4GlcNAc $\beta$ 1  $\rightarrow$  4-GlcNAc characterizes the core portion of rat, whereas oligosaccharide structures derived from human all contain a pentasaccharide core without fucose on the proximal *N*-acetylglucosamine residue. As in the case described above for fibronectin, species related outer chain differences also exist. Rat contains Gal $\beta$ 1  $\rightarrow$  4GlcNAc and Gal $\beta$ 1  $\rightarrow$  3GlcNAc whereas human contains only the former structure but in addition also contains Gal $\beta$ 1  $\rightarrow$  4(Fuca1  $\rightarrow$  3)GlcNAc and Gal $\beta$ 1  $\rightarrow$  4-GlcNAc $\beta$ 1  $\rightarrow$  3Gal $\beta$ 1  $\rightarrow$  4GlcNAc.

These marked structural differences may be the result of different sets of glycosyltransferases present in the Golgi membrane of both animals. The functional role

of species related differences in both core and outer chain moieties remains to be elucidated.

### *Microheterogeneity of the sugar chains of glycoproteins*

As will be described in detail in Part 3, sugar chains of glycoproteins are formed by the sequential action of glycosyltransferases. Since no template as in the case of protein biosynthesis is included in this elongation reaction, the structures of the final sugar chains produced are determined by the specificity of each glycosyltransferase for a particular nucleotide sugar and for a particular glucose acceptor, and by its ability to synthesize a particular type of linkage. This mechanism may explain so called microheterogeneity of sugar chains widely found in the carbohydrate moieties of glycoproteins since a shortage of certain nucleotide sugars, changes in relative glycosyltransferase activities and other factors can theoretically induce changes in the major sugar chain structures. Such a mechanism has been proposed to explain the microheterogeneity of sugar chains isolated from hen egg albumin<sup>29</sup> and bovine pancreatic ribonuclease<sup>30,31</sup>, both of which have a single asparagine-linked sugar chain, but appear to contain a mixture of a series of biosynthetic intermediates as well as completed sugar chains. However, as described below, this view may require modification and a functional and/or structural significance may be associated with this seemingly haphazard biosynthesis of oligosaccharide units.

Recent studies of the sugar chains of human chorionic gonadotropin (HCG) and of blood coagulation factors have provided the first experimental evidence that

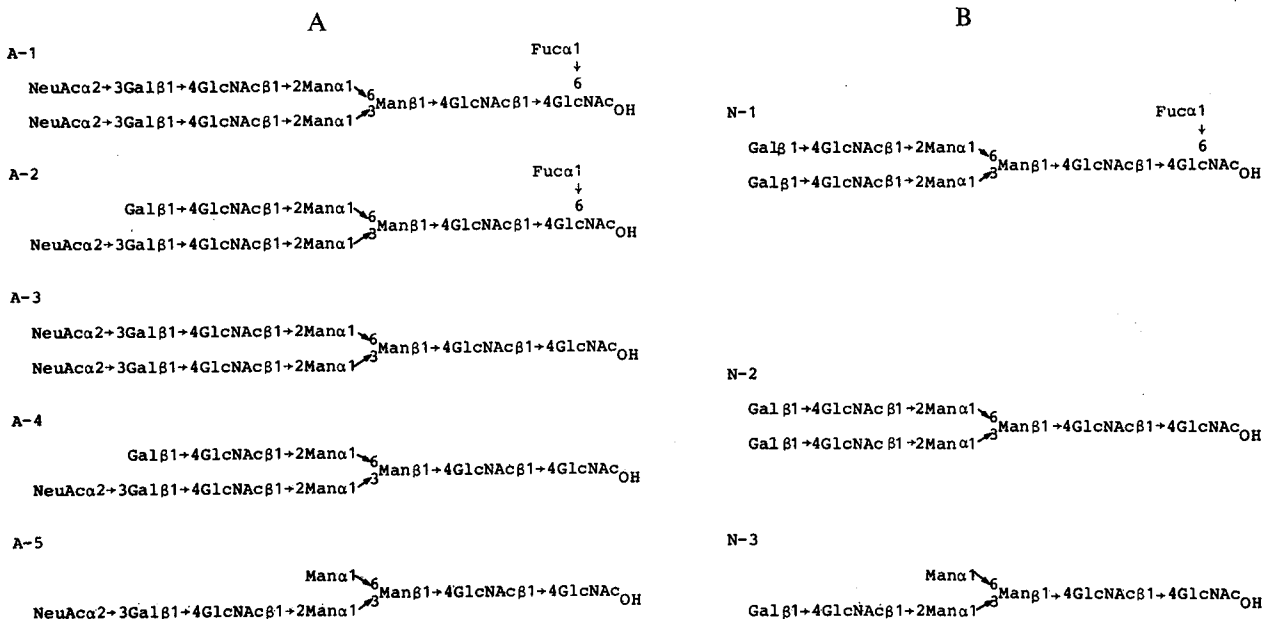

Figure 2. Structures of asparagine-linked sugar chains of HCG (A) and their neutral core portions (B).

this apparent phenomenon of microheterogeneity must be interpreted with care. HCG is composed of 2 polypeptides ( $\alpha$  and  $\beta$  subunits) which are linked by a disulfide bond. The molecule considered in whole contains a series of acidic asparagine-linked sugar chains as listed in figure 2A<sup>32</sup>.

Structurally, A-2 ~ A-5 can be considered as a series of biosynthetically incomplete sugar chains of A-1. Separation of  $\alpha$  and  $\beta$  subunits and analysis of the oligosaccharides in relation to the amino acid sequence however suggests that A-2 ~ A-5 are not simply incomplete biosynthetic products but structurally complete sugar chains<sup>33</sup>. The 5 acidic sugar chains listed in figure 2A contain 1 of the 3 neutral sugar chains shown in figure 2B. These units can readily be separated by Bio-Gel P-4 high resolution column chromatography. When the oligosaccharide mixtures obtained from  $\alpha$  and  $\beta$  subunits of HCG by hydrazinolysis and exhaustive sialidase digestion were analyzed by Bio-Gel P-4 column chromatography, a pattern emerged indicating that the  $\alpha$  subunit contains 1 mole each of N-2 and N-3 and  $\beta$  subunit 1 mole each of N-1 and N-2. Since both subunits contain 2 asparagine residues to which sugar chains are linked<sup>34</sup>, the results indicated that the structure of asparagine-linked sugar chain of HCG is distinct according to the location on the 2 polypeptide chains. Therefore, not only A-1, but A-3 and A-5 are com-

pletely formed sugar chains appropriate to the position of the asparagine residue of HCG molecule.

A second example of this residue specific glycosylation has emerged from the study of blood coagulation factors II and IX. The asparagine-linked sugar chains of these 2 glycoproteins are listed in figure 3. Factor II contains sugar chains A, B and C and factor IX contains these chains plus the sialylated forms D and E. Amino acid sequence studies have revealed the factors II and IX have 3 and 4 asparagine residues which are glycosylated, respectively. A comparative study of the oligosaccharide patterns obtained from glycopeptide fragments of factor II and IX have revealed that the sugar chain C is linked only to Asn-376 of factor II and Asn-261 of factor IX. No triantennary sugar chains (D and E) were found to be linked to Asn-261 of factor IX<sup>35</sup>.

The specific distribution of different sugar chains at different asparagine loci of glycoprotein molecules cannot be explained by our current understanding of the biosynthetic mechanism proposed for the synthesis of asparagine-linked sugar chains. It will be interesting to see at what biochemical level this regulation is maintained. From a functional view point, as will be described in Part 4, this fact may be of particular importance, if the oligosaccharide either alone or in combination with the peptide is to play a role in various recognition processes.

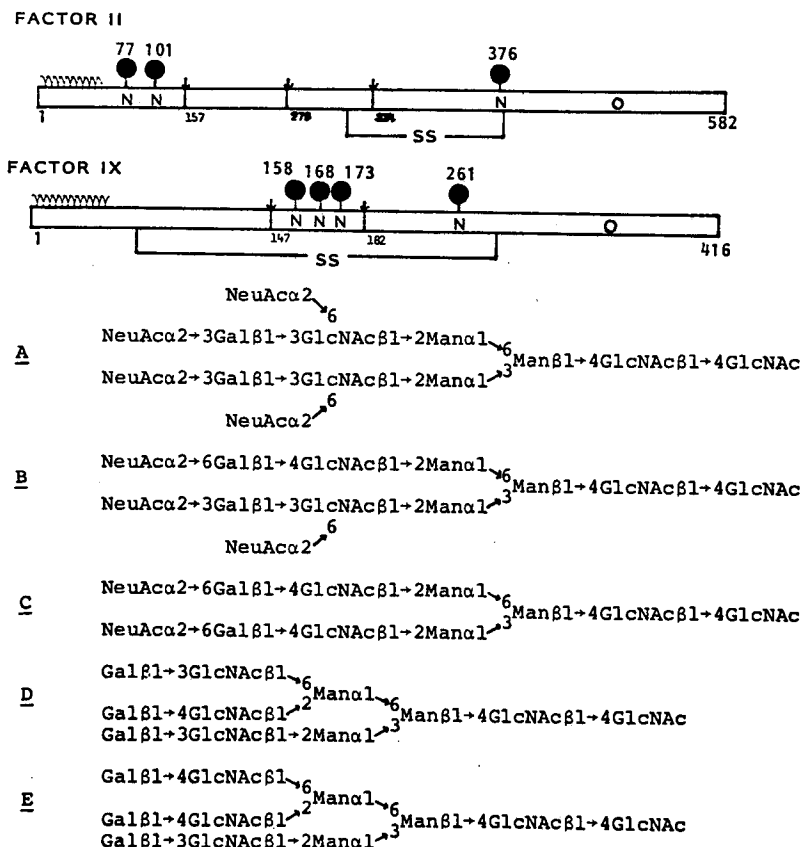

Figure 3. Structures of bovine blood coagulation factors II and IX and their sugar chains.

## Part 2

**Current methodology in the structural analysis of glycoprotein glycans**

The primary structures of carbohydrate chains of glycoproteins are defined by the following parameters: a) Nature and number of the constituting monosaccharides; b) Sequence and ring size of the monosaccharides; c) Type and anomeric configuration of the glycosidic linkages; d) Type of the carbohydrate-peptide linkages; e) Position of the involved amino acids in the polypeptide backbone. For the determination of these parameters, (partial) solvolysis, periodate oxidation, and alkaline and enzymatic degradation, in combination with analytical techniques as paper chromatography, paper electrophoresis, thin-layer chromatography and colorimetry have been often the methods of choice. However, for the investigation of complex structures as occurring in glycoproteins, this arsenal of techniques was not always optimal for providing reliable answers within a reasonable period of time.

The introduction of gas-liquid chromatography (GLC) and mass spectrometry (MS) in carbohydrate chemistry, about 20 years ago, has given new impulses for the structural analysis of carbohydrate chains. A real break-through was the so-called methylation analysis, based on the application of combined GLC-MS and specific chemical derivatizations<sup>36-39</sup>. Furthermore, several new chemical degradations were developed and well-known approaches were improved<sup>12,40-42</sup>. Digestions with exo- and endo-glycosidases<sup>10</sup> and the employment of (<sup>3</sup>H)- and (<sup>14</sup>C)-labeled reagents in derivatization procedures appeared to be also very useful. Finally, the application of high-resolution <sup>1</sup>H-nuclear magnetic resonance (NMR) spectroscopy, introduced about 5 years ago, has had great influence on the further development in structural analyses<sup>43</sup>.

*Preparation of carbohydrate chains accessible for structural analysis*

Numerous glycoproteins, varying with regard to the type of carbohydrate-peptide linkage<sup>44</sup> and the number and structure of the carbohydrate chains (see Part 1) are known to occur in nature. In general, it is not possible to analyze the structures of the carbohydrate chains directly in intact glycoproteins. One of the reasons is the possible occurrence of more than one carbohydrate chain attached to separate amino acids in the polypeptide-backbone. Furthermore, the chains show frequently (micro-)heterogeneity. Also the presence of the polypeptide-backbone as such can interfere with the analysis of carbohydrates.

To obtain suitable products for the analysis of carbohydrate chains of the *N*-glycosidic type and the *O*-glycosidic mucin type (see Part 1), the following degradation methods are commonly used:

1. Degradation of the glycoproteins by exhaustive pronase digestion to glycopeptides having only a few amino acids<sup>9</sup>. To facilitate the isolation and analysis procedures, *N*-terminal amino acids in the glycopeptides can be labeled by *N*-(<sup>3</sup>H)- or *N*-(<sup>14</sup>C)-acetylation<sup>45</sup> or by *N*-dansylation<sup>46</sup>.
2. Cleavage of the GalNAc-Ser/Thr linkage and formation of oligosaccharide-alditols using alkaline borohydride ( $\beta$ -elimination reaction)<sup>47</sup>. Recently, it has been reported that under the same conditions also GlcNAc-Asn linkages seem, to a certain extent, to be split<sup>48,49</sup>. Labeled oligosaccharide-alditols (at position 1 of the alditol unit) can be obtained by employing sodium (<sup>3</sup>H)-borohydride.
3. Cleavage of the GlcNAc-Asn linkage by hydrazinolysis followed by *N*-acetylation and reduction, yielding oligosaccharide-alditols<sup>12</sup>. For labeling of the oligosaccharide-alditols, the working-up procedures can be carried out with (<sup>3</sup>H)- or (<sup>14</sup>C)-acetic anhydride<sup>50</sup> (*N*-acetylation) or with sodium (<sup>3</sup>H)-borohydride<sup>12</sup> (reduction). It has been observed that also GalNAc-Ser/Thr linkages are split for a few percent<sup>12</sup>.
4. Cleavage by endoglycosidases like endo- $\beta$ -*N*-acetylglucosaminidases<sup>10</sup> (cleavage of the core chitobiose unit; to some extent carbohydrate outer chain specific), endo- $\alpha$ -*N*-acetylgalactosaminidase<sup>10</sup>, or aspartylglycosylaminase<sup>51</sup>, releasing oligosaccharides. In case when oligosaccharide-alditols are required, the alditol unit can be marked by reduction with sodium (<sup>3</sup>H)-borohydride.

It has to be noted that radiochemical-labeling of the carbohydrate chains can also be achieved along other routes: a) Use of radioactive precursors as (<sup>3</sup>H)-mannose in glycoprotein biosynthesis<sup>52</sup>; b) Treatment of glycoproteins bearing galactose in terminal position, with galactose-oxidase/sodium (<sup>3</sup>H)-borohydride<sup>53</sup>; c) Treatment of sialoglycoproteins with periodate/sodium (<sup>3</sup>H)-borohydride<sup>54</sup>.

Essential steps after enzymatic and/or chemical degradation are the fractionation and purification to homogeneity of the formed mixtures of glycopeptides, oligosaccharides or oligosaccharide-alditols. In this context gel-filtration<sup>55</sup>, paper chromatography, paper electrophoresis, high-performance liquid chromatography<sup>56-59</sup> (in particular useful as final procedure), ion-exchange chromatography, and affinity chromatography on lectins<sup>45,60-62</sup> have to be mentioned. To facilitate the structural analysis of the purified carbohydrate oligomers, they are frequently subjected to further chemical degradations such as Smith degradation<sup>63</sup>, partial acetolysis<sup>64</sup>, partial hydrolysis or hydrazinolysis/nitrous acid deamination<sup>65</sup>, and to enzymatic degradations with exo- and endo-glycosidases<sup>10</sup>.

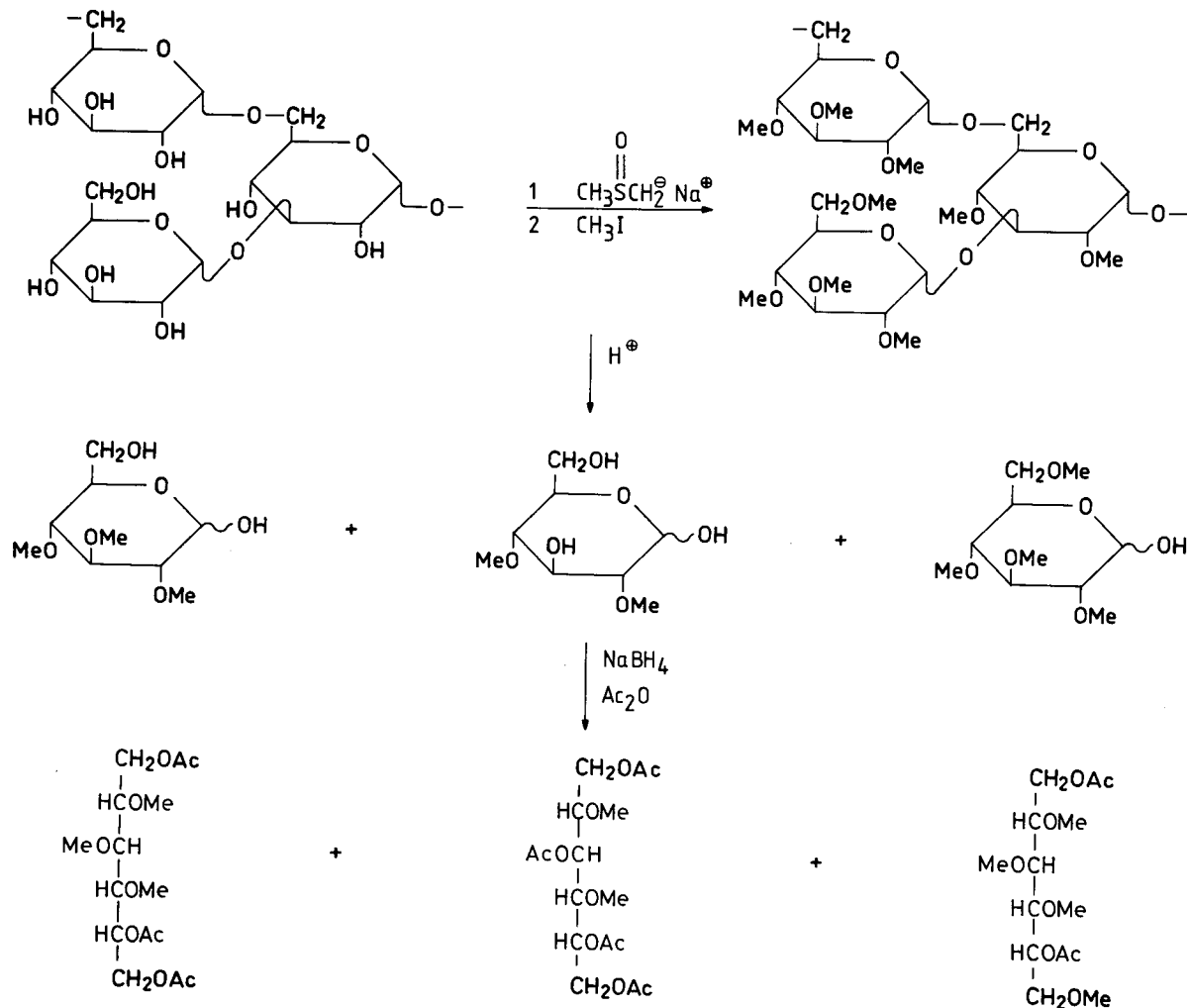

Scheme 1. General working-up procedure in methylation analysis (partially methylated alditol acetates).

### Sugar analysis

The qualitative as well as the quantitative monosaccharide composition of glycoproteins, glycopeptides, oligosaccharides and oligosaccharide-alditols is mainly established after hydrolysis or methanolysis.

In general, the neutral and amino sugars obtained after acid hydrolysis are converted into the corresponding alditol acetates and analyzed by GLC (-MS)<sup>66-68</sup>. Also (1-<sup>3</sup>H)-alditol acetates have been applied<sup>68</sup>. Sialic acids are quantitated mostly colorimetrically<sup>69</sup>, whereas amino sugars can also be analyzed on the amino acid analyzer. For the qualitative determination *N,O*-acetylneuraminic acids, obtained by mild acid hydrolysis of glycoproteins, a specific GLC-electron impact (EI)MS procedure has been developed, making use of the corresponding trimethylsilylated methyl ester derivatives<sup>70-72</sup>.

Methanolysis, causing less destruction of the monosaccharides than hydrolysis<sup>73</sup>, yields a mixture of methyl glycosides of neutral monosaccharides, amino sugars and sialic acid (as methyl ester), which can be determined jointly by GLC(-MS) after *N*-acetylation/

trimethylsilylation<sup>73-76</sup> or trifluoroacetylation<sup>77</sup>. In the latter case the flame-ionization detector has been replaced sometimes by an electron-capture detector<sup>78,79</sup>. It has to be noted that, due to anomerization, for each monosaccharide several methyl glycoside peaks can be obtained. However, each monosaccharide gives rise to its own characteristic peak pattern.

The absolute configuration of monosaccharides can be established by GLC of the corresponding trimethylsilylated (-)-2-butyl glycosides<sup>80,81</sup>. Derivatized *D*- and *L*-monosaccharides show separated peaks on non-chiral stationary GLC phases, as SE-30. In this way, also mixtures of monosaccharides can be analyzed directly.

### Methylation analysis

To gain insight into the substitution pattern and the ring size of the monomers, methylation analysis has proved to be of great importance. A frequently used procedure for neutral and *N*-acetyl amino sugars is given in scheme 1. Free hydroxyl groups in the glycan

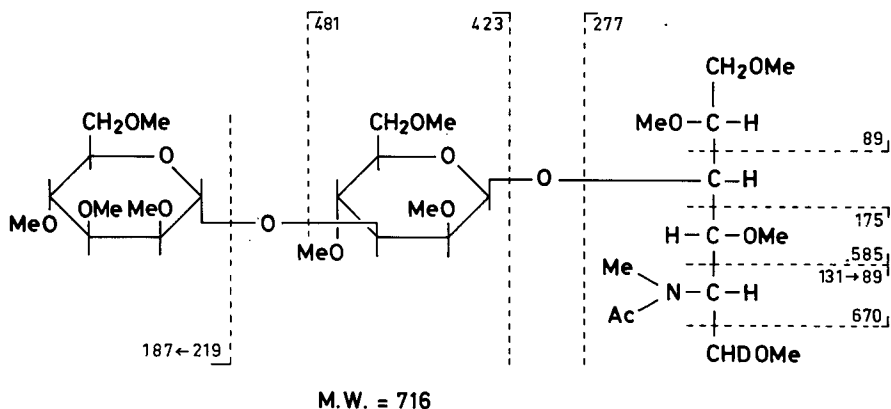

Scheme 2. Structure of permethylated Man $\alpha$ -a(1  $\rightarrow$  3)-Man $\alpha$ - $\beta$ (1  $\rightarrow$  4)-GlcNAc-ol-1- $^2$ H $_1$ , including some specific fragment ions as observed in its EI mass spectrum (see fig. 2).

are converted into methoxyl groups using methyl iodide/sodium methylsulfinyl-methanide/methyl sulfoxide<sup>36,82</sup>. The permethylated material is then hydrolyzed, mostly employing 80–95% acetic acid in 0.5 N sulfuric acid<sup>83,84</sup>, yielding a mixture of partially methylated monosaccharides. The latter mixture is reduced with sodium borohydride, followed by acetylation of the liberated hydroxyl groups with acetic anhydride<sup>83</sup>. The partially methylated alditol acetates derived from neutral and *N*-acetylamino sugars are analyzed by GLC-MS<sup>37–39,82,83,85–87</sup>. The positions of the *O*-methyl and *O*-acetyl groups in these compounds can be deduced from the specific fragmentations observed in the highly characteristic EI mass spectra. The mass spectra are insensitive to stereochemical differences, but the nature of the parent monosaccharides can be derived from the retention times of the alditol derivatives on GLC. Therefore, combination of the GLC and MS data of the different partially methylated alditol acetates indicate the substitution patterns of the monosaccharide residues in the intact biopolymer, and thus the positions of the glycosidic linkages. Also ring size information is obtained. In figure 4 the EI mass spectra of 1,5-di-*O*-acetyl-2,3,4,6-tetra-*O*-methyl-mannitol-1- $^2$ H $_1$ , 1,3,5-tri-*O*-acetyl-2,4,6-tri-*O*-methyl-mannitol-1- $^2$ H $_1$ , and 4-mono-*O*-acetyl-1,3,5,6-tetra-*O*-methyl-2-*N*-methylacetamido-2-deoxy-glucitol-1- $^2$ H $_1$  are depicted. These compounds are formed when the permethylated trisaccharide-alditol-1- $^2$ H $_1$  of Man $\alpha$ -a(1  $\rightarrow$  3)-Man $\alpha$ - $\beta$ (1  $\rightarrow$  4)-GlcNAc $\rho$  (see scheme 2) is subjected to hydrolysis/reduction (with sodium borodeuteride)/acetylation. To prevent possible mass symmetries in the alditol derivatives, it is advantageous to use borodeuteride instead of borohydride for the reduction. To this end, also oximes<sup>88</sup> and aldononitriles<sup>89–91</sup> have been proposed. In specific procedures the application of trideuteriomethyl iodide, ethyl iodide or trideuterioacetic anhydride as protecting reagents have been incorporated<sup>37–39</sup>. For the analysis of complex mixtures, mass fragmentography has shown to be

very helpful. Finally, in contrast to the already mentioned insensitivity of EI for stereochemical differences, chemical ionization (CI) mass spectra of partially methylated alditol acetates seem to contain this information<sup>92</sup>.

For the linkage analysis of sialic acids in non-reducing and internal positions, methanolysis of the permethylated compound is the appropriate method of solvolysis. The resulting (partially) methylated methyl ester methyl  $\beta$ -glycosides show, after treatment with acetylation or acetylation-trimethylsilylation reagents, very characteristic EI mass spectra<sup>72,93,94</sup>. The application of methanolysis has also been worked-out for neutral and amino sugars<sup>95,96</sup>.

#### Mass spectrometry of oligosaccharide, oligosaccharide-alditols and glycopeptides

For investigation by MS a great number of mono- and oligosaccharide derivatives as well as underivatized carbohydrates have been described in the literature<sup>37–39,97–99</sup>. Among the various types of derivatives, those obtained after methylation, trimethylsilylation and acetylation prevail. Most of the reported mass spectrometric data concern with EIMS, but also CIMS, desorption chemical ionization (DCI) MS, field ionization (FI) MS and field desorption (FD) MS have been applied<sup>37–39</sup>. Recently, fast atom bombardment (FAB) has been introduced as a new 'soft' ionization method. For EI, CI and FI conversion of polar saccharides into thermally more stable, volatile derivatives is important. Depending on the volatility of the derivatives, GLC is included too; for instance, GLC-MS has been performed up to permethylated tetrasaccharides. DCI, FD and FAB can also be applied successfully for the analysis of underivatized saccharides.

Fundamental studies with respect to oligosaccharide analysis have been carried out by several research groups with the aim of developing general MS methods for the determination of the sequence of the monosaccharide residues in terms of hexoses, deoxy-



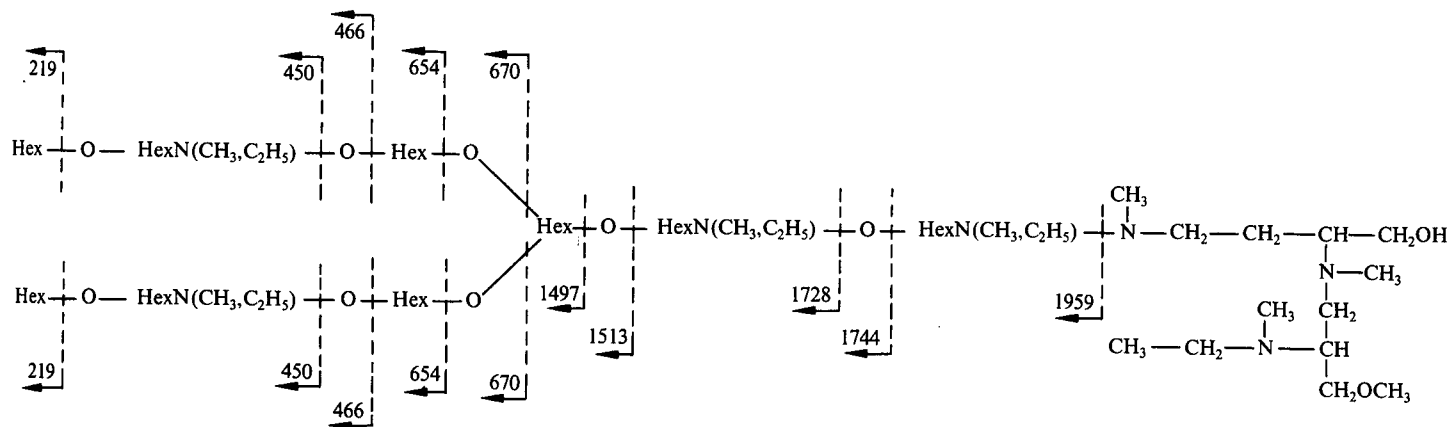

molecular weight 2219

Scheme 3. Sequence information from the EI mass spectrum (60 eV) of *N*-acetylated, permethylated and reduced Galp- $\beta$ (1  $\rightarrow$  4)-GlcNAc $\rho$ - $\beta$ (1  $\rightarrow$  2)-Manp- $\alpha$ (1  $\rightarrow$  3)-[Galp- $\beta$ (1  $\rightarrow$  4)-GlcNAc $\rho$ - $\beta$ (1  $\rightarrow$  2)-Manp- $\alpha$ (1  $\rightarrow$  6)-]Manp- $\beta$ (1  $\rightarrow$  4)-GlcNAc $\rho$ -(1  $\rightarrow$  4)-GlcNAc $\rho$ - $\beta$ (1  $\rightarrow$  N)-(Ser)-Asn.

hexoses, acetamidohexoses and sialic acids, and for the determination of the positions of the glycosidic bonds between the monosaccharides. From these investigations it has become evident that the determination of the positions of the glycosidic bonds is difficult. For several disaccharide derivatives discrimination rules to establish the type of glycosidic linkage have been reported; also higher saccharides were included in these model studies<sup>37-39, 100-107</sup>.

In the analysis of the carbohydrate chains of glycoproteins, the derived oligosaccharides, oligosaccharide-alditols and glycopeptides have mostly been studied after permethylation. As a typical example, in figure 5 the EI mass spectrum of permethylated Manp- $\alpha$ (1  $\rightarrow$  3)-Manp- $\beta$ (1  $\rightarrow$  4)-GlcNAc-ol-1-<sup>2</sup>H<sub>1</sub> (scheme 2) is presented. Although the spectrum does not show a molecular ion peak, the molecular weight can be deduced easily from the abundant primary fragment ion *m/z* 670 (*m* minus CHDOME). The monosaccharide sequence Hex  $\rightarrow$  Hex  $\rightarrow$  HexNAc-ol-1-<sup>2</sup>H<sub>1</sub> is proved by the presence of the sequence fragment ions *m/z* 481, 423, 277, 219 and 187 (see scheme 2 for the explanation). Information concerning the position of the linkage between Hex and HexNAc-ol-1-<sup>2</sup>H<sub>1</sub> is indicated by the *m/z* values 89 and 175. The absence of *m/z* 337 (bcJ<sub>1</sub>-fragment according to the symbol rules as reported in references 97 and 108; CH<sub>3</sub>OCHO-HexNAc-ol-1-<sup>2</sup>H<sub>1</sub>) suggests the occurrence of a 3-linked Hex  $\rightarrow$  HexNAc-ol-1-<sup>2</sup>H<sub>1</sub> unit. Larger structures like permethylated sialo- and asialo-diantennary glycopeptides give rise to more complicated EI mass spectra<sup>109</sup>. Sequence information obtained from the spectrum of the *N*-acetylated, permethylated and reduced asialoglycopeptide Galp- $\beta$ (1  $\rightarrow$  4)-GlcNAc $\rho$ - $\beta$ (1  $\rightarrow$  2)-Manp- $\alpha$ -(1  $\rightarrow$  3)-[Galp- $\beta$ (1  $\rightarrow$  4)-GlcNAc $\rho$ - $\beta$ (1  $\rightarrow$  2)-Manp- $\alpha$ -(1  $\rightarrow$  6)-]Manp- $\beta$ (1  $\rightarrow$  4)-GlcNAc $\rho$ - $\beta$ (1  $\rightarrow$  4)-GlcNAc $\rho$ - $\beta$ -(1  $\rightarrow$  N)-(Ser)-Asn is presented in scheme 3. These 2 examples demonstrate the usefulness of mass spec-

trometry, especially in sequence analyses. Only a few examples on CIMS are known. The technique mainly gives rise to intense quasimolecular ions, but also sequence ions are observable. A survey of analyzed oligosaccharides, oligosaccharide-alditols and glycopeptides can be obtained from references 37-39, 64, 65, 109-125.

FIMS and DCIMS have not yet been used in the structural analysis of carbohydrate chains, derived from glycoproteins. In most cases only model studies on commercially available saccharides have been carried out. In addition to model studies, FDMS has been applied for the analysis of a carbohydrate chain of the *N*-glycosidic type (oligomannoside)<sup>126</sup>. All 3 approaches show molecular and/or quasimolecular ions in the spectra, thus enabling the determination of molecular weights. The possibility to get sequence information has been mentioned too. (For a comprehensive review, see reference 38).

Up to now, no reports on FABMS have appeared in the field of glycoprotein chemistry. Introductory experiments from the author's laboratory have shown that this new ionization technique seems to be very promising. The spectra of underivatized oligosaccharides and glycopeptides (positive or negative ion mode) give information about their molecular weights. Several intense quasimolecular ions, as M+H, M+Na, M+K (positive ion mode) or M-H (negative ion mode), can be present. Furthermore, sequence information is available to a certain extent. In principle, this type of MS offers also possibilities to detect (micro-)heterogeneity in carbohydrate chains without time-consuming derivatization procedures. In scheme 4 the results of negative ion FABMS is depicted for an asialodiantennary glycopeptide, namely Galp- $\beta$ (1  $\rightarrow$  4)-GlcNAc $\rho$ - $\beta$ (1  $\rightarrow$  2)-Manp- $\alpha$ -(1  $\rightarrow$  3)-[Galp- $\beta$ (1  $\rightarrow$  4)-GlcNAc $\rho$ - $\beta$ (1  $\rightarrow$  2)-Manp- $\alpha$ -(1  $\rightarrow$  6)-]Manp- $\beta$ (1  $\rightarrow$  4)-GlcNAc $\rho$ - $\beta$ (1  $\rightarrow$  4)-GlcNAc $\rho$ - $\beta$ -(1  $\rightarrow$  N7)-Asn.

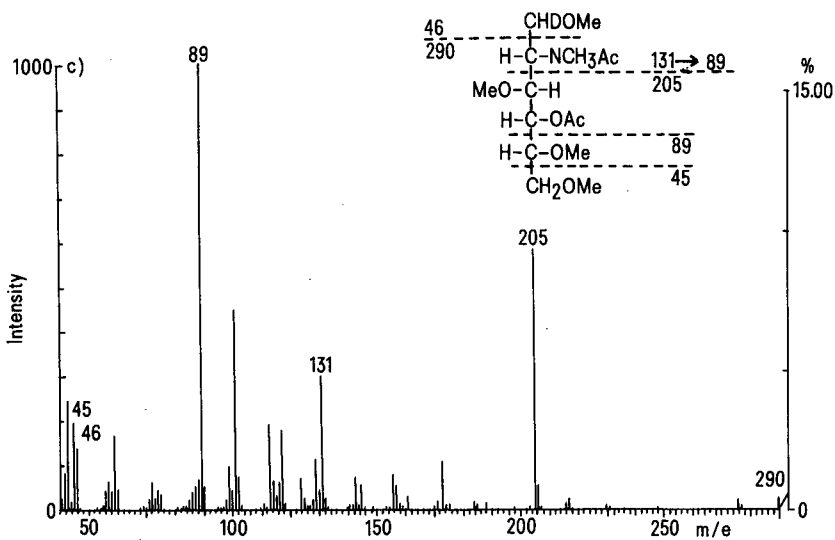
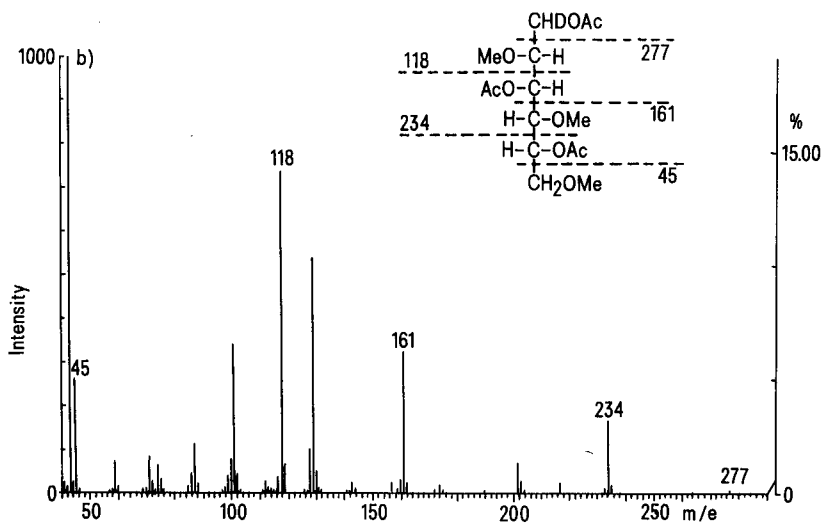
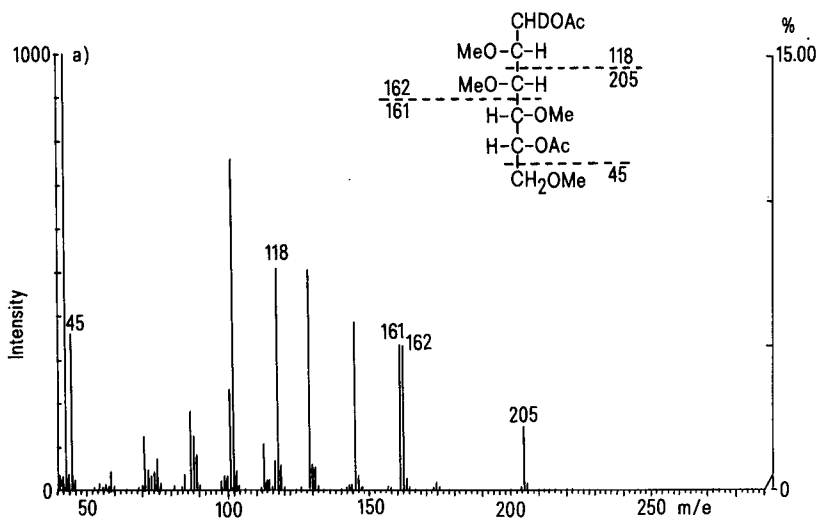

Figure 4. EI mass spectra (70 eV) of the partially methylated alditol acetates of (a) 1,5-di-*O*-acetyl-2,3,4,6-tetra-*O*-methyl-mannitol-1-<sup>2</sup>H<sub>1</sub>, (b) 1,3,5-tri-*O*-acetyl-2,4,6-tri-*O*-methyl-mannitol-1-<sup>2</sup>H<sub>1</sub>, and (c) 4-mono-*O*-acetyl-1,3,5,6-tetra-*O*-methyl-2-*N*-methyl-acetamido-2-deoxy-glucitol-1-<sup>2</sup>H<sub>1</sub>.

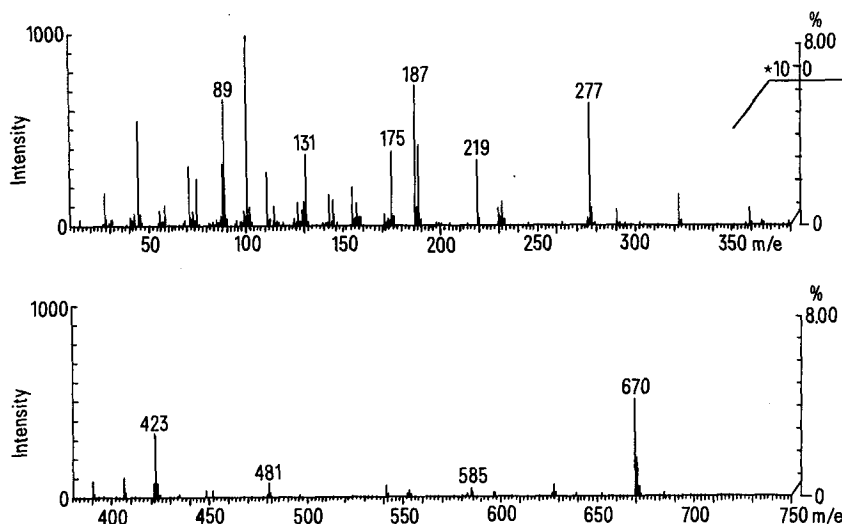
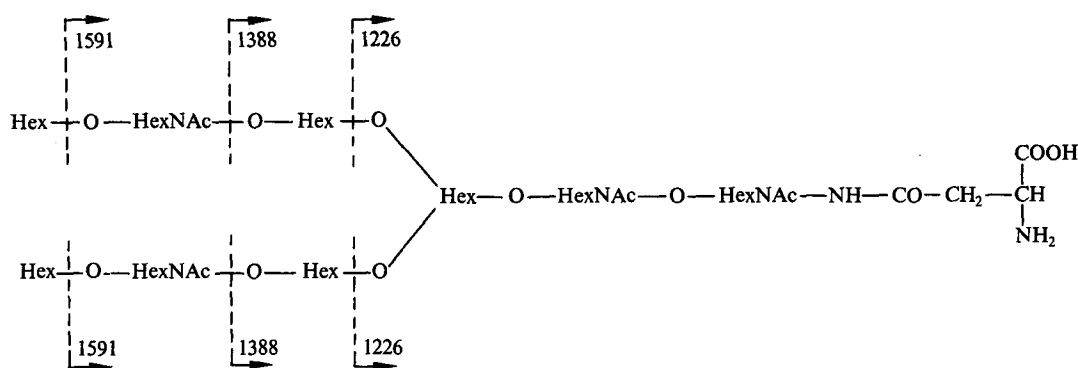

Figure 5. EI mass spectrum (70 eV) of permethylated  $\text{Manp-}\alpha(1 \rightarrow 3)\text{-Manp-}\beta(1 \rightarrow 4)\text{-GlcNAc-ol-1.}^2\text{H}_1$ .



molecular weight 1754

- |                                  |                                   |
|----------------------------------|-----------------------------------|
| $m/z$ 1753 $M-H$                 | $m/z$ 1416 $[1388 + HCO]-H$       |
| $m/z$ 1735 $[M - H_2O]-H$        | $m/z$ 1388 $[1388 + H]-H$         |
| $m/z$ 1619 $[1591 + HCO]-H$      | $m/z$ 1370 $[1388 + H - H_2O]-HH$ |
| $m/z$ 1591 $[1591 + H]-H$        | $m/z$ 1254 $[1226 + HCO]-H$       |
| $m/z$ 1573 $[1591 + H - H_2O]-H$ | $m/z$ 1226 $[1226 + H]-H$         |

Scheme 4. Sequence information from the negative ion FAB mass spectrum of  $\text{Galp-}\beta(1 \rightarrow 4)\text{-GlcNAcp-}\beta(1 \rightarrow 2)\text{-Manp-}\alpha(1 \rightarrow 3)\text{-[Galp-}\beta(1 \rightarrow 4)\text{-GlcNAcp-}\beta(1 \rightarrow 2)\text{-Manp-}\alpha(1 \rightarrow 6)]\text{Manp-}\beta(1 \rightarrow 4)\text{-GlcNAcp-}\beta(1 \rightarrow 4)\text{-GlcNAcp-}\beta(1 \rightarrow N)\text{-Asn}$ .

### Application of glycosidases

The application of highly purified, well-characterized exoglycosidases in combination with gel-filtration under standard conditions has shown to be useful in monosaccharide sequencing of oligosaccharide chains<sup>10,55</sup>. For example oligosaccharide-alditols (<sup>3</sup>H)-labeled in the alditol unit can be subjected to successive exoglycosidase digestions. In a certain sequence of digestions, the degradation can be followed readily by intermediate gel-filtration analysis. Although this approach is often used in conjunction with methylation analysis, also other analytical methods can be incorporated at every stage. Especially, the combination with <sup>1</sup>H-NMR spectroscopy will be successful.

### High-resolution <sup>1</sup>H-NMR spectroscopy

High-resolution <sup>1</sup>H-NMR spectroscopy is now generally recognized as an invaluable technique for the investigation of the structure, conformation and intramolecular interactions of biomolecules<sup>127</sup>. In 1977 this technique was introduced by us for the elucidation of the primary structure of carbohydrate chains derived from glycoproteins<sup>128</sup>. Since then, the scope of this approach could be widened considerably, due to further progress in NMR instrumentation leading to spectrometers which operate at magnetic fields up to 11.7 Tesla (equivalent to a frequency of 500 MHz), in combination with advances in computer capabilities<sup>43, 129, 130</sup>.

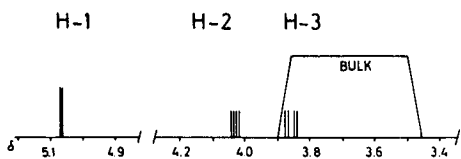
Man  $\alpha$ 

H-1 } position of attachment to adjacent Man  
type of linkage.  
H-2 } substituents at C-2, C-3, C-4, C-6

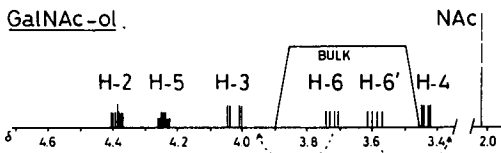
GalNAc-ol.

H-2 } substituent at C-3  
(H-3) }  
H-5 } substituent at C-6  
H-6 }  
H-6' }  
NAc } overall sequential arrangement

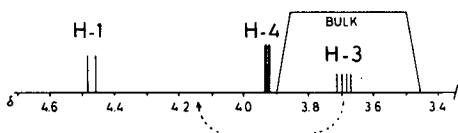
Gal  $\beta$ 

H-1 } residue and position of attachment  
type of linkage.  
H-3 } substituents at C-2, C-3, C-4, C-6  
H-4 }

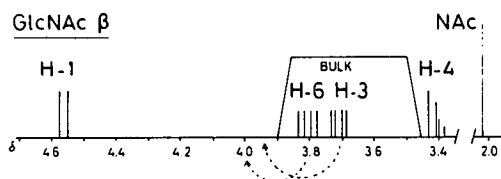
GlcNAc  $\beta$ 

H-1 } residue and position of attachment  
type of linkage.  
H-3 } substituents at C-3, C-4  
H-4 }  
H-6 }  
NAc } overall sequential arrangement

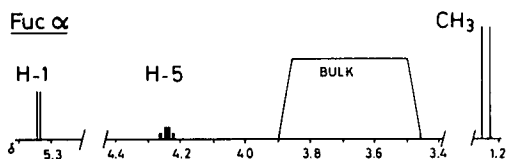
Fuc  $\alpha$ 

H-1 } residue and position of attachment  
H-5 } type of linkage  
CH<sub>3</sub> }

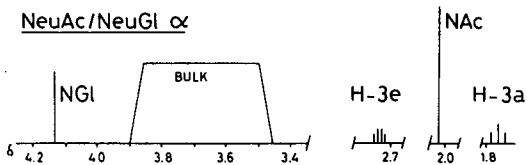
NeuAc/NeuGI  $\alpha$ 

H-3a } residue and position of attachment  
H-3e } type of linkage  
(NAc/NGI)

Scheme 5. Schematic representation of the structural reporter group signals of the principal constituents monosaccharide residues of carbohydrate chains released from glycoproteins. The structural information contained in the chemical shifts of the signals is indicated briefly.

$^1\text{H-NMR}$  studies on glycoproteins can in principle be carried out on intact molecules. However, with regard to the structure of the carbohydrate chains only some information on the outer parts can be obtained, provided that the chains are not too short. For the same reasons as pointed out before, partial structures in the form of glycopeptides, oligosaccharides or oligosaccharide-alditols have to be prepared.

The 500-MHz  $^1\text{H-NMR}$  spectra recorded of  $^2\text{H}_2\text{O}$  solutions of the aforementioned partial structures provide structural information on the carbohydrate chain at several different levels.

First of all, the spectrum can be applied as an identity card. The spectral patterns contain so many details and are that characteristic that a spectrum is unique. Comparison of the spectra of compounds allows to conclude whether or not compounds are identical. At

this stage, it is not necessary that the spectrum can be interpreted. To take full advantage of the possibilities of  $^1\text{H-NMR}$  spectroscopy, it is advisable to record spectra before detailed chemical and/or enzymatic structural studies are carried out, since NMR is nondestructive.

Secondly, the  $^1\text{H-NMR}$  spectrum can be interpreted in terms of primary structure of the carbohydrate chain. Usually the spectrum is far too complex to be assigned completely by a first-order approach. In particular the bulk signal, which stems from the majority of the non-anomeric skeleton protons demands for the employment of more advanced NMR techniques. A discussion of the latter is beyond the scope of this article. However, the signals of a number of protons, the so-called structural reporter groups, resonate at clearly distinguishable spectral

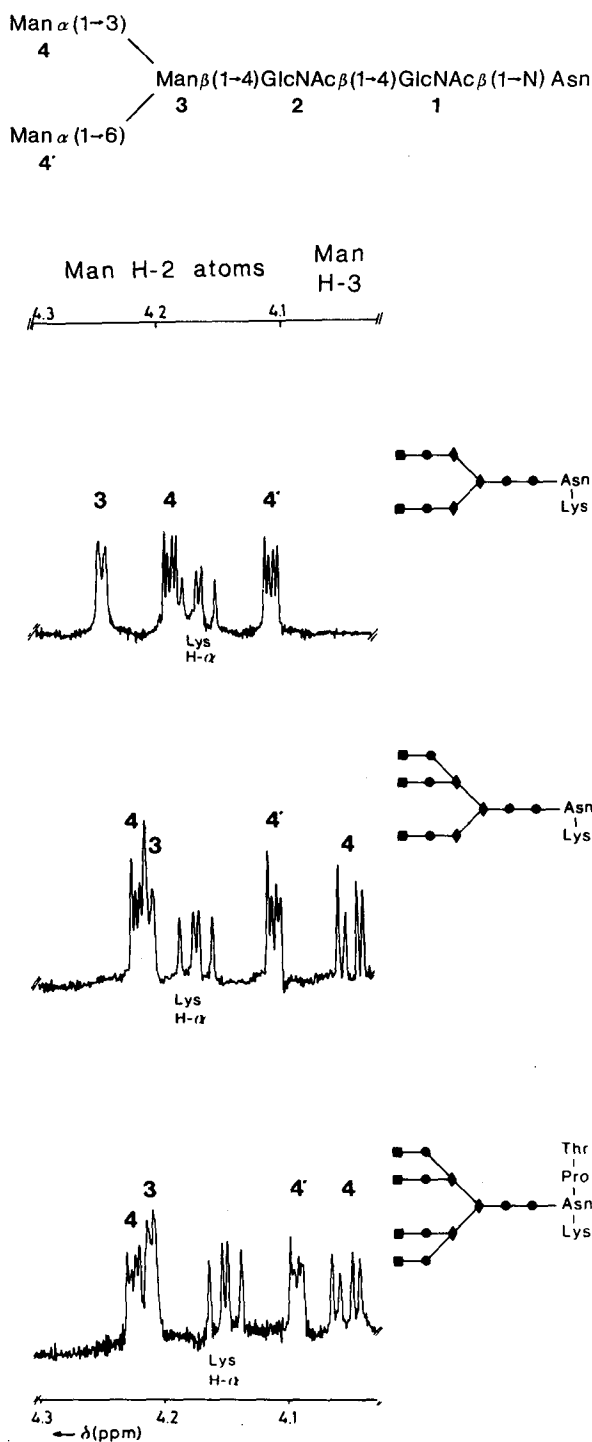

Figure 6. Characteristic patterns of the H-2 structural reporter groups of the 3 core mannose residues in the 500-MHz  $^1\text{H-NMR}$  spectra of di-, tri- and tetraantennary glycopeptide structures. The numbers in the figure refer to the corresponding Man-residues. ●, GlcNAc; ◆, Man; ■, Gal.

positions depending on the (primary) structure. The chemical shifts, coupling constants and line widths of the reporter group signals furnish the essential structural information. Structural reporters are the following protons:

a) The anomeric protons; b) The protons attached to carbon atoms in the direct vicinity of a substitution position in a sugar; c) The protons attached to deoxy carbon atoms (fucose, sialic acids); d) The *N*-acetyl group protons of *N*-acetyl amino sugars and sialic acids. For a few frequently occurring sugar residues their schematic spectra, which show the structural reporter group signals, are given in scheme 5.

As pointed out in part 1 the *N*-glycosidically linked carbohydrate chains are characterized by a common pentasaccharide core. In the  $^1\text{H-NMR}$  spectra the resonances belonging to structural reporter groups of the core residues are typical for the asparagine-linked carbohydrate chains. Extensions of this core with additional monosaccharides may give rise to 1. the *N*-acetylglucosamine, 2. the oligomannoside, 3. the hybrid type of compounds. Each extension comes to expression in its own structural group signals as well as in its specific influences on the signals of other residues. An illustration of the latter effects can be found in the H-2 reporter group signals of the 3 core mannose residues, which reflect the core substitution pattern as depicted in figure 6. It should be noted that terminating residues like fucose, sialic acid, intersecting *N*-acetylglucosamine and  $\alpha$ -linked galactose have also their own characteristic influences. A typical spectrum of an often occurring sialodiantennary structure is presented in figure 7. The unambiguous assignment of the structural reporter group signals was derived from comparison of the spectra of compounds with increasing complexity of primary structures and from specific NMR techniques<sup>130</sup>.

For the study of carbohydrate chains of the *O*-glycosidic mucin type the alditols obtained after alkaline borohydride reduction are very well suited<sup>131</sup>. A representative example is given in figure 8.

In addition, the spectra furnish information on the homogeneity of the samples. Consideration of the number of structural reporter group signals in conjunction with the intensity of the signals (integration) is a good approach for determination of the quantitative carbohydrate composition. On this basis it is possible to ascertain if (micro-)heterogeneity in the sample occurs and to which type this belongs. For example, the preparations may contain compounds which differ in chain length by one or more residues<sup>43,132</sup>. Alternatively, isomeric structures may be present differing in position or type of linkage of one or more residues<sup>43,133</sup>. In fact 500-MHz  $^1\text{H-NMR}$  spectroscopy has shown to be able to disclose new types of microheterogeneity, which can hardly be traced along other routes.

A further interesting application of this method is the monitoring of enzymatic reactions with regard to carbohydrate substrates and products, either directly in the NMR apparatus or discontinuously after isolation of the compounds involved. In this way, insight



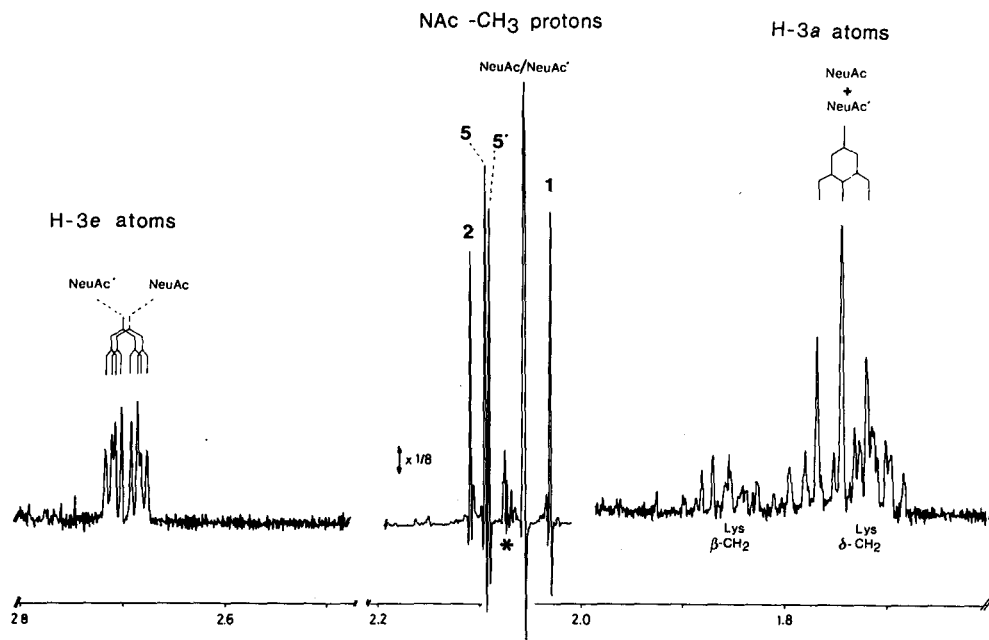

Figure 7. 500-MHz <sup>1</sup>H-NMR spectrum of NeuAc- $\alpha$ (2  $\rightarrow$  6)-Galp- $\beta$ (1  $\rightarrow$  4)-GlcNAcp- $\beta$ -(1  $\rightarrow$  2)-Manp- $\alpha$ (1  $\rightarrow$  3)-[NeuAc- $\alpha$ (2  $\rightarrow$  6)-Galp- $\beta$ -(1  $\rightarrow$  4)-GlcNAcp- $\beta$ (1  $\rightarrow$  2)-Manp- $\alpha$ (1  $\rightarrow$  6)-]-Manp- $\beta$ -(1  $\rightarrow$  4)-GlcNAcp- $\beta$ (1  $\rightarrow$  4)-GlcNAcp- $\beta$ (1  $\rightarrow$  N)-Asn-Lys in <sup>2</sup>H<sub>2</sub>O at 25 °C and p<sup>2</sup>H = 7. \* Contaminants.

was obtained in the specificity of the enzymatic transfer of sialic acid to different branches in di- and tri-antennary structures<sup>143</sup>. For in vitro studies on the biosynthesis of the carbohydrate chains of glycoproteins, this technique is well suited.

Finally, high-resolution <sup>1</sup>H-NMR spectroscopy may provide essential data regarding the spatial structure and segmental mobility of carbohydrate chains<sup>130</sup>. For gaining insight into the interaction and recognition processes wherein these chains are involved, detailed knowledge of the architecture of the molecules involved is indispensable. It can be expected that in this respect high-resolution <sup>1</sup>H-NMR spectroscopy will contribute significantly.

Part 3

Biosynthesis of glycoprotein glycans

Glycosyltransferases

Glycosyltransferases catalyze the stepwise synthesis of both N-linked and O-linked oligosaccharides by carrying out the transfer of a sugar residue from an activated donor substrate to the hydroxyl group of an acceptor substrate on the growing oligosaccharide chain<sup>135,136</sup>. Donor substrates are usually nucleotide sugar derivatives (table 3) although the lipid linked sugars dolicholphosphorylmannose (Dol-P-Man) and

dolicholphosphorylglucose (Dol-P-Glc) also serve as donor substrates for several enzymes. Glycosyltransferases are often grouped into families based on the type of sugar transferred (sialyltransferase, galactosyltransferase, fucosyltransferase, etc.). Within families individual enzymes can readily be distinguished by their specificity for acceptor substrates and the type of anomeric linkage formed in the product. As an example, the reaction of a sialyltransferase<sup>139,140</sup> which terminates N-linked oligosaccharides, is shown below.

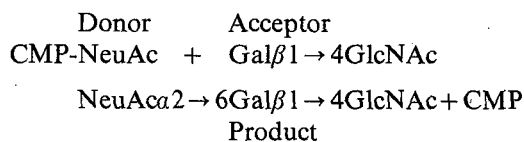

This enzyme utilizes the sequence Gal $\beta$ 1  $\rightarrow$  4GlcNAc as a preferred acceptor sequence and is virtually inactive toward the Gal $\beta$ 1  $\rightarrow$  3GlcNAc and Gal $\beta$ 1  $\rightarrow$  3GalNAc sequences which are effective substrates for other sialyltransferases<sup>135,136</sup>. It also forms only the NeuAc $\alpha$ 2  $\rightarrow$  6Gal linkage and not the NeuAc $\alpha$ 2  $\rightarrow$  3Gal or NeuAc $\alpha$ 2  $\rightarrow$  4Gal linkages which also occur as terminal sequences in glycoprotein oligosaccharides (s. Part 1). Thus, this sialyltransferase elaborates the sequence NeuAc $\alpha$ 2  $\rightarrow$  6Gal $\beta$ 1  $\rightarrow$  4GlcNAc with high fidelity and exemplifies the strict specificity which is required of glycosyltransferases for the syn-

Table 3. Glycosyltransferase donor substrates of sugars commonly found in oligosaccharides of glycoproteins

Monosaccharide	Donor substrates
Sialic acid	CMP-NeuAc
Galactose	UDP-Gal
N-Acetylgalactosamine	UDP-GalNAc
N-Acetylglucosamine	UDP-GlcNAc
Fucose	GDP-Fuc
Mannose	GDP-Man
Glucose	Dolichol-P-Man UDP-Glc Dolichol-P-Glc

thesis of oligosaccharides of defined sequence. The earliest indications of the specificity of glycosyltransferases prompted the 'one linkage-one enzyme' hypothesis which predicts a different enzyme for each glycosidic linkage found in oligosaccharides of glycoproteins<sup>141, 142</sup>. In general the observed specificities of purified glycosyltransferases have supported this hypothesis<sup>135, 136</sup>.

#### Subcellular localization of synthesis

The relationship between the intracellular organelles involved in glycoprotein biosynthesis is shown in figure 9. Glycoprotein polypeptides are synthesized by membrane bound polyribosomes of the rough endoplasmic reticulum (RER, see reviews 137, 143). During synthesis they are extruded into the lumen of the RER where they either remain membrane bound, or become soluble depending on their ultimate destination (i.e. cell surface vs secreted). The biosynthesis of *N*- and *O*-linked oligosaccharides differ in a number of respects and will be discussed separately. In general, however, glycosylation is initiated in the RER during or shortly after synthesis of the polypeptide (reviewed in reference 137). Then, apparently by means of coated vesicles<sup>143, 144</sup>, the glycoproteins are transported to the Golgi where processing and terminal glycosylation is completed<sup>137, 145, 146</sup>. From the Golgi, plasma membrane and secretory glycoproteins are transported to the cell surface, and lysosomal enzymes are transported to the lysosomes. The mechanism of transport and sorting out of glycoproteins among these organelles is currently of considerable interest<sup>145-149</sup>. Aspects of these problems will be considered further below.

#### Biosynthesis of oligosaccharides *O*-linked to threonine or serine

**Sequential glycosylation.** The synthesis of *O*-linked oligosaccharides appears to occur almost entirely by sequential glycosylation where the product of one glycosyltransferase is utilized as an acceptor substrate by another glycosyltransferase<sup>135, 136</sup>. Synthesis begins with the transfer of *N*-acetylgalactosamine to the hydroxyl group of threonine or serine by the enzyme UDP-GalNAc: polypeptide transferase.

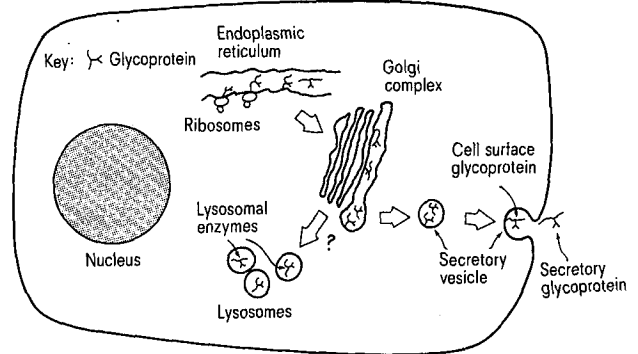
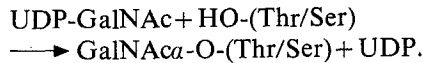

Figure 9. Subcellular localization of oligosaccharide biosynthesis.



No intermediate appears to be required in this reaction<sup>150</sup> since it is carried out efficiently *in vitro* by the polypeptide *N*-acetylgalactosaminyltransferase partially purified from a variety of sources<sup>135, 136</sup>. A specific polypeptide sequence around the threonine or serine does not appear to be required for glycosylation, although a lack of secondary structure to allow accessibility of the transferase may be important<sup>151</sup>. Strous<sup>152</sup> has reported the presence of *N*-acetylgalactosamine on peptidyl-RNA isolated from polyribosomes of gastric mucosa suggesting that the initial glycosylation event can occur on nascent chains as they are being synthesized on the rough ER. However, several investigators have found that the levels of the polypeptide *N*-acetylgalactosaminyltransferase is 10-fold less concentrated in the RER than in the smooth ER and Golgi<sup>150, 153, 154</sup>. Thus, in which organelle the initiation of the majority of *O*-linked oligosaccharides takes place is still an open question. For the synthesis of a linear oligosaccharide, like the trisaccharide  $\text{NeuAc}\alpha 2 \rightarrow 3\text{Gal}\beta 1 \rightarrow 3\text{GalNAc}\alpha\text{Thr/Ser}$  found on fetuin, the biosynthetic pathway is straightforward. In this case 3 glycosyltransferases, an *N*-acetylgalactosaminyltransferase, a galactosyltransferase and a sialyltransferase acting sequentially are required. However, for branched structures like the A blood group positive pentasaccharide found in porcine submaxillary mucin (figure 10A), the possible biosynthetic pathways are more numerous. The question arises, which of the possibilities, if any, is preferred?

The proposed pathway for the biosynthesis of the porcine mucin pentasaccharide is shown in figure 10B. After the sequence  $\text{GalNAc}\alpha\text{Thr/Ser}$  is formed, either galactose or sialic acid can be transferred next. Schachter et al.<sup>155</sup> showed that the galactose must be added next since the galactosyltransferase would not transfer galactose to the sequence  $\text{NeuAc}\alpha 2 \rightarrow 6\text{GalNAc}\alpha\text{Thr/Ser}$ . Thus, addition of sialic acid before galactose would terminate the oligosaccharide as a disaccharide.



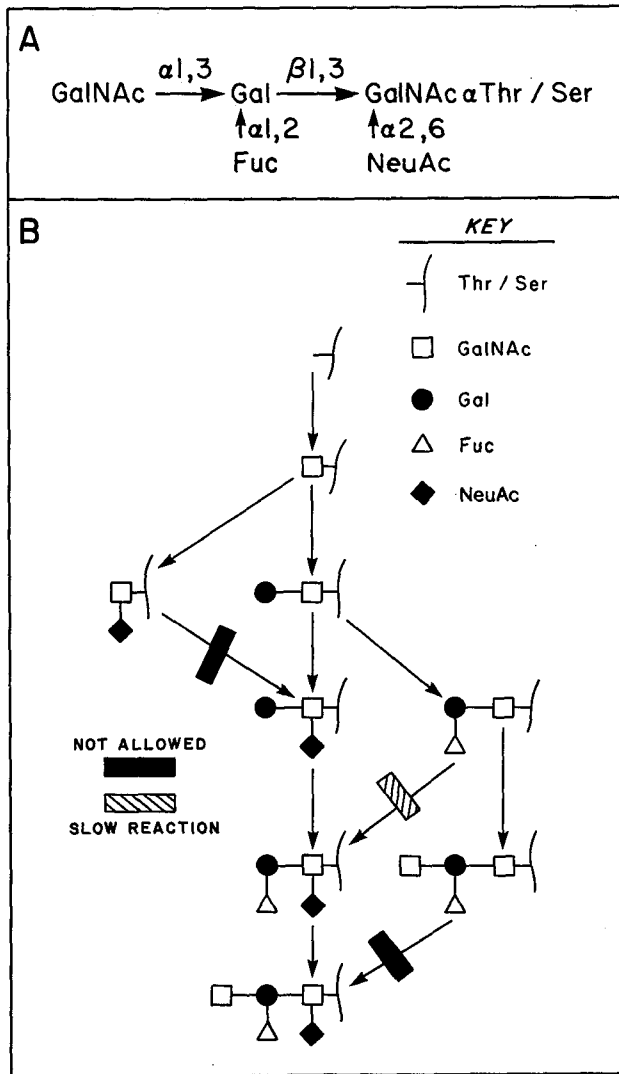

Figure 10. Biosynthesis of the *O*-linked oligosaccharides of porcine submaxillary mucin. The structure of the most complete mucin oligosaccharide, a penta-saccharide, is shown in panel A. Its biosynthesis, in symbol form, is depicted in panel B with the preferred order of addition of sugars shown in the center. Alternate pathways branching to the sides result in dead end products due to the inability of glycosyltransferases to carry out the reactions indicated by the hatched or solid blocks. Adapted from Beyer et al.<sup>156</sup>.

Glycosylation steps following formation of the sequence Gal $\beta$ 1  $\rightarrow$  3GalNAc $\alpha$ Thr/Ser have been studied by Beyer et al.<sup>156</sup> using 3 homogeneous glycosyltransferases purified from porcine submaxillary glands. Each of the possible tri- and tetrasaccharide intermediates en route to the complete penta-saccharide were tested as substrates for the glycosyltransferases which add the non-reducing terminal sialic acid, fucose and *N*-acetylgalactosamine residues. The results, summarized in figure 10B, showed that the preferred order of addition is sialic acid, fucose and *N*-acetylgalactosamine, respectively. The sialic acid must be added first since the fucosylated oligosaccharides are poor substrates for the sialyltransferase and the *N*-acetylgalactosamine must be added last

since the *N*-acetylgalactosaminyltransferase requires the Fuca1  $\rightarrow$  2Gal sequence as a substrate. Thus the specificity of the glycosyltransferases dictate that sequential glycosylation must proceed in the order shown in the center of figure 10B to achieve the completed penta-saccharide found in porcine submaxillary mucin.

*Control of oligosaccharide structure.* As described in Part 1 of this review, the structures of *O*-linked oligosaccharides are diverse. Even within a single glycoprotein, the oligosaccharide structures exhibit considerable microheterogeneity<sup>157</sup>. The factors which influence the ultimate structures of *O*-linked oligosaccharide have not been studied systematically, but several generalisations can be made from available information.

On first principles it would seem evident that oligosaccharide structure is under genetic control at the level of the expression of the number and type of glycosyltransferases which are produced in a cell. One well documented example of this is the genetic basis for the A, B and 0 blood groups which are determined by the carbohydrate structures present on red cell glycoproteins and glycolipids (see references 135, 136). All 3 blood group structures have in common the terminal precursor sequence Fuca1  $\rightarrow$  2Gal. Blood group A is determined by an additional *N*-acetylgalactosamine residue GalNAc $\alpha$ 1  $\rightarrow$  3(Fuca1  $\rightarrow$  2)Gal, and blood group B by an additional galactose residue, Gala1  $\rightarrow$  3(Fuca1  $\rightarrow$  2)Gal. The genes which determine A and B blood groups are codominant alleles which code for the A blood group  $\alpha$ -*N*-acetylgalactosaminyltransferase and B blood group  $\alpha$ -galactosyltransferase, respectively<sup>158-162</sup>. Individuals with the 0 blood group express neither enzyme since the 0 gene is inactive. An analogous situation exists in pigs where A blood group structures like that shown in figure 10A appear in the *O*-linked oligosaccharides of the porcine mucins. The mucins of A-pigs lack such structures and do not express the A blood group *N*-acetylgalactosaminyltransferase<sup>163</sup>.

The relative amounts of the various glycosyltransferases produced by a cell may also determine which of several alternate biosynthetic pathways will predominate. Using again the example of porcine mucin oligosaccharides (fig. 10), structural studies by Carlson<sup>22</sup> showed that the most complex penta-saccharide represented only about 10-15% of the total *O*-linked oligosaccharides. Equally abundant were several of the 'dead end' products produced by the branched pathways in figure 10B. In fact, most or all of the structures in the biosynthetic scheme depicted in figure 10B were found to be present in porcine submaxillary mucin. Thus, it appears that all possible biosynthetic pathways allowed by the specificities of the glycosyltransferases are utilized. The situation at

branch points can simply be viewed as competition for a common acceptor substrate by two glycosyltransferases. The flux through any given pathway would then be determined by the relative amounts of the 2 branch point glycosyltransferases and the availability of their respective donor substrates.

The effects of the different ratios of 2 glycosyltransferases acting at a branch point on the overall oligosaccharide structures of a glycoprotein was pointed out by Schachter et al.<sup>155</sup> while studying oligosaccharide biosynthesis of porcine and ovine submaxillary mucins. In contrast to the porcine mucin, over 95% of the oligosaccharide chains of ovine submaxillary mucin have the terminal sequence NeuAca2 → 6GalNAcaThr/Ser. While both porcine and ovine submaxillary glands contain the galactosyltransferase which forms the sequence Galβ1 → 3GalNAcaThr/Ser, the ratio of sialyltransferase to galactosyltransferase is 10–30 times higher in ovine glands. Thus, considering the first branch point in the biosynthetic scheme of figure 10B, virtually all synthesis in ovine glands appears to proceed by the branch resulting in the terminal disaccharide sequence NeuAca2 → 6GalNAc, while in porcine glands the branch leading to the synthesis of higher oligosaccharides is also utilized.

A final consideration concerning the amounts of glycosyltransferases produced is whether there is sufficient enzyme to drive the reaction to completion. A major source of heterogeneity observed in glycoprotein oligosaccharides is due to incomplete glycosylation. For example, as much as 30% of the *O*-linked oligosaccharides of porcine submaxillary mucins are simply GalNAcaThr/Ser<sup>22</sup>. This suggests that the galactosyl- and sialyltransferases which act on this structure are not present in sufficient quantities to convert the monosaccharide chains to disaccharide chains before the mucin is secreted from the cell. However, the degree to which insufficient levels of glycosyltransferases present in a cell are the cause of incomplete glycosylation has not been established. Other factors such as the availability of donor substrates and the unequal accessibility of the enzymes to all glycosylation sites may also be important<sup>135, 136</sup>.

#### *Biosynthesis of oligosaccharides N-linked to asparagine*

Following the observation of Parodi et al. in 1972 that a glucose containing lipid linked oligosaccharide could be transferred to protein<sup>164</sup>, there has been an explosion of information from many laboratories confirming the role of lipid linked oligosaccharide precursors in the synthesis of *N*-linked oligosaccharides, and unfolding in rich detail the processing steps required to convert the newly transferred protein-bound precursor to the oligosaccharide structures of mature glycoproteins (see reference 137 for an excellent current review and also references 135, 136, 138, 165–

170). The relationship between the structure of the lipid linked precursor and the structures of representative high mannose and complex type *N*-linked oligosaccharides is shown in figure 11. The lipid linked precursor with the composition Glc<sub>3</sub>Man<sub>α</sub>-GlcNAc<sub>2</sub> linked to diphosphoryldolichol has been reported in a variety of cultured cell lines and in yeast<sup>137</sup>. Its structure, established largely by Li et al.<sup>171</sup>, contains the constant Man<sub>3</sub>GlcNAc<sub>2</sub> core region found in most or all *N*-linked oligosaccharides. The biosynthesis of the lipid linked precursor, its transfer to protein and its conversion by subsequent processing steps to the major structure types found as *N*-linked oligosaccharides of mature glycoproteins are discussed below.

*Biosynthesis of the lipid linked precursor:* The lipid linked oligosaccharide precursor is synthesized by the sequential addition of sugars to the lipid moiety, dolichol phosphate (P-Dol). The biosynthetic scheme, which has been termed the dolichol phosphate cycle<sup>172</sup>, is shown in figure 12. Synthesis is carried out by membrane bound glycosyltransferases of the RER<sup>173</sup> with dolichol serving as a membrane anchor for the growing oligosaccharide chain. There is apparent conflicting evidence as to whether synthesis occurs on the cytoplasmic<sup>174, 175</sup> or luminal<sup>176</sup> surface of the membranes.

The first glycosylation event (fig. 12-I) is the transfer of GlcNAc-P from UDPGlcNAc to P-Dol yielding the diphosphoryl dolichol derivative GlcNAc-P-P-Dol. This reaction is specifically inhibited by the antibiotic tunicamycin<sup>177, 178</sup> which is widely used as an inhibitor of *N*-linked glycosylation<sup>168</sup>. Elongation to the linear trisaccharide ManβGlcNAcβGlcNAc-P-P-Dol is carried out by glycosyltransferases which use UDP-GlcNAc and GDP-Man as donor substrates, respectively (see reviews 168–170).

Chapman et al.<sup>179</sup> have suggested that the outer mannose and glucose residues are added preferentially in an ordered sequence. This was inferred from structural studies of the lipid linked oligosaccharides of CHO cells in which only one major isomeric species of each size oligosaccharide was found (Man<sub>3</sub>GlcNAc<sub>2</sub>, Man<sub>5</sub>GlcNAc<sub>2</sub>, etc). Although Man-P-Dol was initially thought to serve as the only mannose donor substrate (see reviews 164, 165) it now appears that GDP-Man is the direct donor for the first 5 mannose residues (fig. 12-III) and Man-P-Dol for the remaining 4 (fig. 12-IV)<sup>180–183</sup>. Indeed, a mutant lymphoma cell line which is deficient in Man-P-Dol synthesis makes Man<sub>5</sub>GlcNAc<sub>2</sub>-P-P-Dol (fig. 12-III) as the largest non-glucosylated lipid linked oligosaccharide<sup>182, 183</sup>.

Three glucose residues are apparently added last (fig. 12-V) with Glc-P-Dol as the donor substrate (reviewed in references 137, 170). This yields the completed lipid linked oligosaccharide, Glc<sub>3</sub>Man<sub>5</sub>-GlcNAc<sub>2</sub>, which is the most abundant oligosaccharide

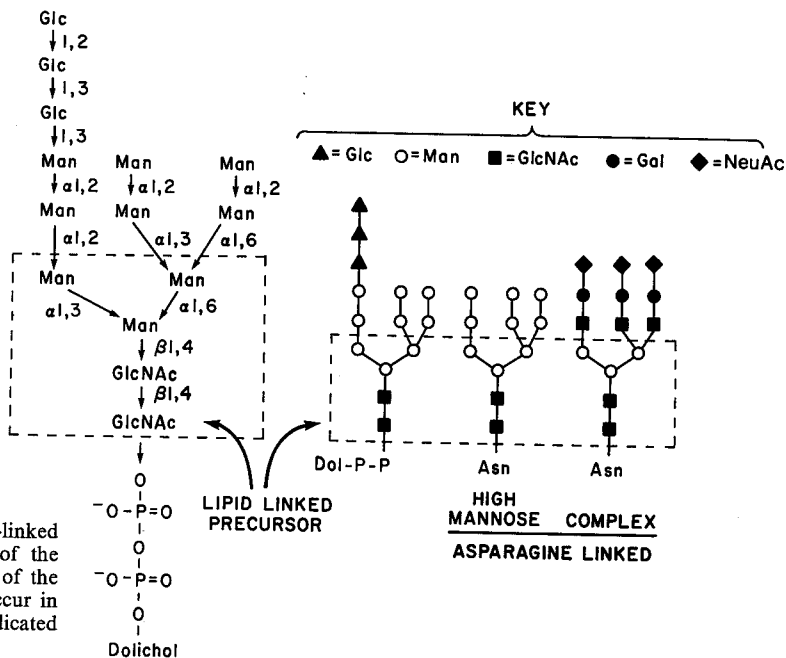

Figure 11. Relationship between lipid-linked and asparagine-linked oligosaccharides. Shown is the oligosaccharide structure of the lipid-linked precursor and, in symbol form, the structures of the high-mannose and complex type oligosaccharides which occur in glycoproteins. The constant  $\text{Man}_3\text{GlcNAc}_2$  core region is indicated in the boxes bounded by a broken line.

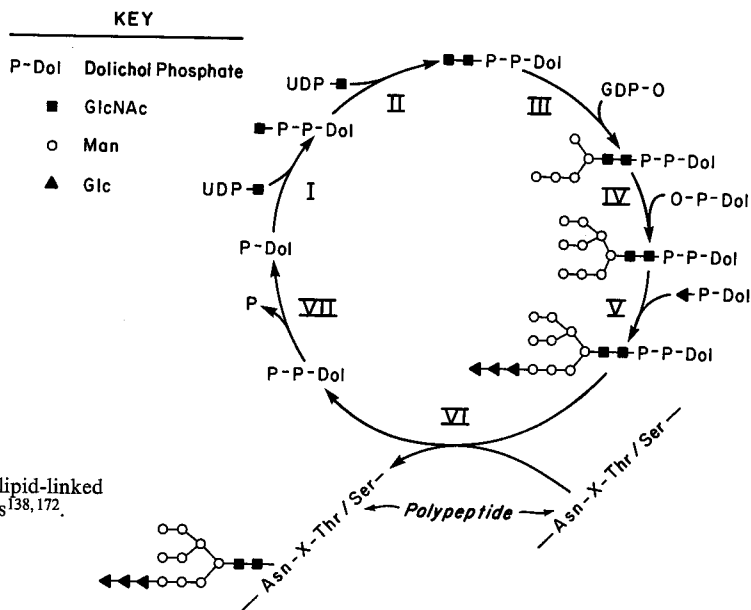

Figure 12. Dolichol phosphate cycle: Synthesis of the lipid-linked oligosaccharide precursor. Adapted from Sharon and Lis<sup>138,172</sup>.

lipid in normal cultured cells<sup>179,184,185</sup>. Following addition of the 3 glucose residues, the lipid linked oligosaccharide precursor may be transferred en bloc to newly synthesized protein releasing diphosphoryl-dolichol (fig. 12-VI). Removal of 1 phosphate then completes the dolichol phosphate cycle (fig. 12-VII).

*Transfer to polypeptide:* Ample evidence suggests that the completed lipid linked oligosaccharide precursor can be transferred to the nascent polypeptide as it is extruded into the lumen of the endoplasmic reticulum during synthesis by membrane bound polysomes, but transfer may not always be cotranslational (reviewed

in reference 137). The enzymatic properties of the transferase (dolichodiphosphoryl-oligosaccharide: polypeptide oligosaccharyltransferase) that carries out this reaction have been extensively characterized. Transfer is only to asparagine when found in the sequence Asn-X-Thr/Ser where X can be almost any other amino acid (see review 168). However, asparagine in this sequence is not always glycosylated<sup>168</sup>. Several studies suggest that accessibility of the sequence may also be a factor. For example, non-glycosylated sequences in native glycoproteins can be glycosylated in vitro after denaturation<sup>186,187</sup>.

Predictive analysis of protein structure from polypeptide sequences suggest that many glycoprotein oligosaccharides occur at exposed  $\beta$ -turns or loops of the peptide chain<sup>187,188</sup>. Thus, since secondary and tertiary structure appear to develop rapidly during synthesis of the polypeptide<sup>189</sup>, glycosylation of some Asn-X-Thr/Ser sequences may be sterically prevented. While oligosaccharide lipids as small as GlcNAc<sub>2</sub>-P-P-Dol are able to serve as donor substrates for the transferase in vitro<sup>190,191</sup>, the glucosylated oligosaccharides appear to be the best substrates. Removal of one or more glucose residues from the most complete Glc<sub>3</sub>Man<sub>9</sub>GlcNAc<sub>2</sub> species dramatically reduces the ability of the oligosaccharide lipid to serve as a donor substrate<sup>192,193</sup>. Removal of mannose residues on the other hand has little effect on the efficiency of transfer<sup>194</sup>. Indeed, the Man-P-Dol deficient lymphoma cell line<sup>179,185</sup> and glucose starved CHO cells<sup>195</sup> which have Glc<sub>3</sub>Man<sub>5</sub>GlcNAc<sub>2</sub> as the largest species of oligosaccharide lipid are fully competent to carry out *N*-linked glycosylation. The fact that glucose residues are added last and that their presence is required for efficient transfer, insures that the completed Glc<sub>3</sub>Man<sub>9</sub>GlcNAc<sub>2</sub> precursor of normal cells is the predominant oligosaccharide incorporated into glycoproteins.

*Processing of glycoprotein oligosaccharides:* After transfer of the lipid linked precursor to protein, glycosidases begin degrading the oligosaccharide to structures of smaller size. The earliest evidence for this was obtained independently by the three laboratories of Robbins<sup>196</sup>, Kornfeld<sup>197</sup> and Summers<sup>197a</sup>. These studies showed that oligosaccharide destined to become a structure of the complex type, eventually lose all but three mannose residues, and terminal sugars are then added by sequential glycosylation. Many details of the processing pathway have since emerged and are summarized in figure 13. This biosynthetic scheme shows the relationship between a number of the major structure types observed in asparagine linked oligosaccharides of mature glycoproteins.

Soon after transfer to protein (fig. 13-1) the 3 glucose residues are removed (fig. 13-2, reviewed in reference 137) yielding a structure identical to high mannose type oligosaccharides found in calf thyroglobulin<sup>198</sup> and a myeloma IgM<sup>199</sup>. Thus, with no further processing the glycoprotein will have oligosaccharides of the high mannose type. The factors which determine cessation of processing at this stage are not entirely understood. However, analysis of the oligosaccharides of influenza virus hemagglutinins which contain mul-

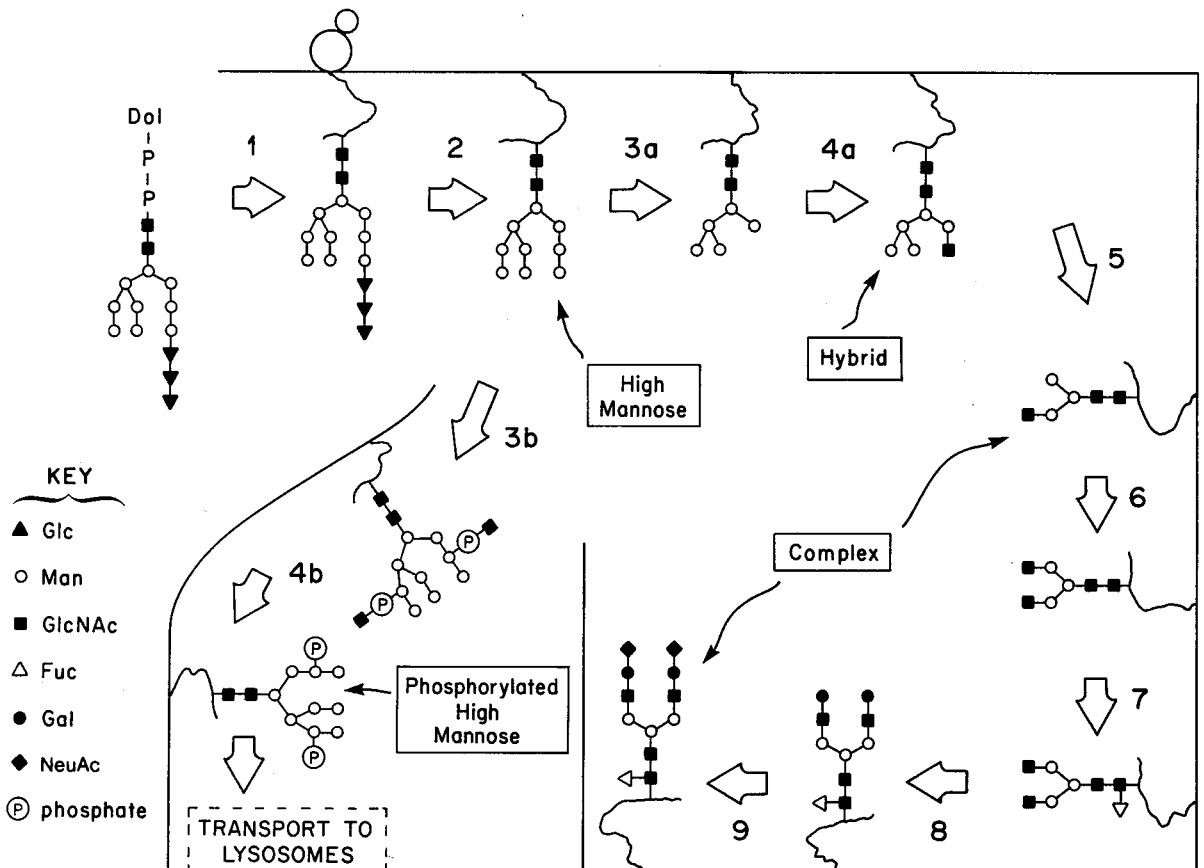

Figure 13. Processing and terminal glycosylation of *N*-linked oligosaccharides. Adapted from Kornfeld et al.<sup>232</sup> and Reitman et al.<sup>233</sup>.

tiple glycosylation sites and both complex and high mannose structure types in the same molecule, has revealed that the oligosaccharides are not randomly distributed<sup>200,201</sup>. Instead, individual glycosylation sites have predominantly high mannose or complex structures but not both<sup>201</sup>. These observations and those of other studies employing viral glycoproteins<sup>137</sup> suggest that the polypeptide structure around the glycosylation site may be one factor that determines the degree of processing.

Removal of mannose residues is the next stage of processing en route to the synthesis of complex type oligosaccharides (fig. 13-3a). The first mannose residues appear to be removed after a 10-min lag period following transfer to protein<sup>184</sup>. This delay may correspond to the time required for the transport of the deglycosylated glycoprotein from the endoplasmic reticulum to the Golgi<sup>144,202</sup>. Indeed, the glucosidases appear to be localized primarily in the endoplasmic reticulum<sup>203</sup> and the mannosidases in the Golgi<sup>204,205</sup>. Initially 4 mannose residues are removed (fig. 13-3a) giving rise to smaller high mannose type structures which have been found as oligosaccharides of secretory glycoproteins (see Part 1). The resulting structure (Man<sub>5</sub>GlcNAc<sub>2</sub>) is composed of the constant core (Man<sub>3</sub>GlcNAc<sub>2</sub>) and 2 additional mannose residues. Further processing cannot occur without the obligatory addition of *N*-acetylglucosamine to the exposed core mannose<sup>206,207</sup> (fig. 13-4a). The resulting intermediate forms the basis of hybrid structure types since it still contains two 'non-core' mannose residues and the first of the terminal *N*-acetylglucosamines found in complex type structures. The hybrid structure shown in figure 13 is found in bovine rhodopsin<sup>209</sup>, and other hybrid structures differ primarily by addition of one or more *N*-acetylglucosamine residues (see Part 1). Addition of *N*-acetylglucosamine to the internal core mannose to give a bisected structure (Part 1) has been suggested to block removal of the last 2 non core mannose residues resulting in stable hybrid structures<sup>207</sup>.

Further processing of oligosaccharides is accomplished by a Golgi mannosidase which rapidly removes the final 2 non-core mannose residues once *N*-acetylglucosamine has been added<sup>206,207</sup>, (fig. 13-5). This yields the simplest complex type structure, and is found in bovine rhodopsin<sup>116,208</sup>. Larger complex structures are built up by the sequential addition of *N*-acetylglucosamine, fucose, galactose and sialic acid as shown for a relatively simple biantennary structure in figure 13-6 to 13-9.

*Terminal glycosylation of complex type oligosaccharides:* Complex type oligosaccharides are quite diverse differing mainly in the number of terminal branches<sup>136-138</sup>, in the length of the branches and in the pattern of substitution of sialic acid and fucose

residues (see Part 1). Microheterogeneity of *N*-linked structures in a glycoprotein, even at a single glycosylation site<sup>209,210</sup> has been well documented. The factors which determine the ultimate structures of complex type oligosaccharides are most likely similar to those discussed for the sequential glycosylation of *O*-linked oligosaccharides. For example, sequential ordered addition appears to be required in the reactions represented in figure 13-6 to 13-8. Here, addition of fucose in  $\alpha 1 \rightarrow 6$  linkage to the *N*-acetylglucosamine attached to asparagine (fig. 13-7) must be after addition of the terminal *N*-acetylglucosamine residues distant from the glycosylation site (fig. 13-6), and before addition of galactose (fig. 13-8), since the fucosyltransferase uses only *N*-acetylglucosamine terminated oligosaccharides as acceptor substrates<sup>135,211,212</sup>. Competition of glycosyltransferases for a common substrate is also found as seen for a sialyltransferase and fucosyltransferase which use the sequence Gal $\beta 1 \rightarrow 4$ GlcNAc to form the terminal structures NeuAca<sub>2</sub>  $\rightarrow 6$ Gal $\beta 1$  and Gal $\beta 1 \rightarrow 4$ (Fuca $1 \rightarrow 3$ )GlcNAc, respectively. The product of either enzyme is inactive as a substrate of the other enzyme precluding the synthesis of a structure containing both sialic acid and fucose<sup>156,213</sup>. These and other examples<sup>135,136</sup> emphasize the importance of the type and relative amounts of specific glycosyltransferases produced by a cell in the determination of the structure of complex type oligosaccharides.

Multiglycosyltransferase complexes have been proposed by Ivatt<sup>214</sup> as a means by which sequential ordered addition of monosaccharides may be facilitated. To date in vitro evidence for such complexes has been obtained for a galactosyltransferase and *N*-acetylglucosaminyltransferase which synthesize the Gal $\beta 1 \rightarrow 4$ GlcNAc sequence attached to the Man<sub>3</sub>-GlcNAc<sub>2</sub> core<sup>214</sup>. Further studies will be required to determine the generality of this phenomenon.

Recent reports suggest that the subcellular organization and site of synthesis of complex type oligosaccharides may be more complex than previously thought. Both influenza virus and vesicular stomatitis virus (VSV) produce membrane glycoproteins with complex type oligosaccharides, yet when grown in MDCK cells, the membrane glycoproteins for influenza are exported to the apical surface while those of VSV are transported to the basal surface<sup>215</sup>. Monensin, an ionophore which affects Golgi function, abolishes the transport of influenza virus glycoproteins to the cell surface under conditions which do not affect the transport of VSV glycoproteins<sup>216</sup>. Lodish and coworkers<sup>217</sup>, have similarly studied in hepatocytes the biosynthesis of the VSV membrane glycoprotein and transferrin, a secreted glycoprotein with complex type oligosaccharides. In the presence of monensin, transferrin is secreted with high mannose type oligosaccharides while those of the VSV glyco-

protein remained the complex type. The results suggest more than one intracellular pathway for the biosynthesis and routing of glycoproteins with complex type oligosaccharides.

**Phosphorylated high mannose oligosaccharides of lysosomal enzymes:** Following the observations of Neufeld and coworkers<sup>147</sup> that normal lysosomal enzymes could be taken up by cultured fibroblasts of patients with lysosomal enzyme deficiencies (see review, 147) Hickman et al.<sup>218</sup> proposed that lysosomal enzymes contained a carbohydrate specific recognition marker necessary for the binding of the enzymes to the cell surface receptor which mediated uptake. Evidence that the recognition marker was mannose-6-phosphate was obtained by Kaplan et al.<sup>219</sup> when mannose-6-phosphate was shown to be a potent inhibitor of the uptake of lysosomal enzymes. The presence of mannose-6-phosphate in oligosaccharides of lysosomal enzymes was subsequently confirmed by direct analysis and the phosphorylated oligosaccharides were shown to be of the high mannose type<sup>52, 220-223</sup>. Mannose-6-phosphate is now believed to be a specific recognition marker for the normal routing of lysosomal enzymes to the lysosomes<sup>52, 147</sup>. Indeed, patients with the mucopolysaccharide storage disorder I-cell disease are deficient in oligosaccharide phosphorylation<sup>223-225</sup>, and many of their lysosomal enzymes are not sequestered into lysosomes but are instead secreted<sup>147</sup>. The functional significance of the mannose-6-phosphate recognition marker is discussed in detail in Part 4.

Biosynthesis of the phosphorylated oligosaccharides appears to be a branch of the major processing pathway. The initial phosphorylation event<sup>52, 226</sup> is the transfer of GlcNAc-P from UDP-GlcNAc to a high mannose type oligosaccharide (fig. 13-3b). The *N*-acetylglucosamine residue is subsequently removed (fig. 13-4b) to expose the Man-6-P recognition site<sup>52, 161</sup>. Both the *N*-acetylglucosaminylphosphotransferase and the *N*-acetylglucosaminidase appear to be localized in the Golgi<sup>227, 228</sup>. Since the high mannose oligosaccharides are on all glycoproteins passing through the Golgi, what prevents nonlysosomal enzymes from being phosphorylated and directed to lysosomes? Reitman and Kornfeld<sup>229</sup> have studied the ability of the *N*-acetylglucosaminylphosphotransferase to utilize as substrates high mannose oligosaccharides of several lysosomal enzymes, and several secretory glycoproteins. Compared to the lysosomal enzymes, IgM, ovalbumin, thyroglobulin and ribonuclease B were relatively poor substrates despite the fact that their high mannose oligosaccharides were virtually identical. It was suggested that the *N*-acetylglucosaminylphosphotransferase selectively phosphorylates oligosaccharides of lysosomal enzymes through recognition of an amino acid sequence or

unique polypeptide conformation not found in non-lysosomal glycoproteins<sup>229, 230</sup>.

Once lysosomal enzymes are phosphorylated and the phosphates are uncovered by removal of *N*-acetylglucosamine, they are presumably routed from the Golgi to the lysosomes. The mechanism of transport between these organelles is of considerable interest. While the Man-6-P receptor on cultured fibroblasts<sup>231</sup> can mediate the transport of lysosomal enzymes from the culture fluid to the lysosomes, its role in the intracellular transport of lysosomal enzymes has also been proposed (see reviews, references 147, 149). Further studies are required to elucidate the details of lysosomal enzyme transport and compartmentalization, and how general these processes are to all tissues and cell types.

#### Part 4

#### The functions of glycoprotein glycans

An intriguing concept of heteroglycan function is based on the disclosure that certain carbohydrates may represent highly specific compounds acting as carriers of biological information. This capability arises from the great variety of oligosaccharide structures that can be formed from a relative small number of monosaccharides (see Part 1). Taking in account differences in the anomeric configuration and position of the glycosidic bonds, for example 3 molecules of the same hexose (e.g. galactose) can form 176 different trisaccharides, while 3 molecules of the same amino acid can form only 1 tripeptide, and 3 nucleotides containing the same base can form only 1 codon. The monosaccharides may serve as letters in a code of biological specificity comparable to the specific nucleotide or amino acid sequences of nucleic acids and proteins, respectively.

The various functions of glycoconjugates may be attributed to the following main properties of carbohydrates:

- a) Biological recognition. The common molecular basis underlying the function of carbohydrates in biological recognition is the interaction of oligosaccharides or polysaccharides with carbohydrate binding proteins: A specific determinant or marker formed by a saccharide sequence has affinity to complementary structures in other molecules.
- b) Protein folding and conformation. A second important role of the carbohydrates is their ability to influence protein folding and conformation.
- c) Stabilizing biological membranes. Furthermore cell surface glycoproteins act possibly as structural components to stabilize cell membranes both in archaebacteria and eucaryotes.

The major sources of information on the function of carbohydrates are: a) studies on the molecular basis

of genetic disorders of glycoconjugate metabolism; b) the use of lectins which have selective binding capacity towards specific carbohydrate sequences; c) the use of drugs such as tunicamycin that are specific inhibitors of glycosylation and d) the influence of glycosidases on functional oligosaccharide structures. Over the past years several comprehensive reviews, monographs and research reports<sup>4-8,172,234</sup> on glycoconjugates and their function have been published.

*Recognition*

The interaction of specific oligosaccharide sequences with complementary carbohydrate binding proteins may be exemplified on cell-molecule interactions, cell-cell interactions or binding between molecules in solution (molecule-molecule interactions).

Cell-molecule interaction is the initial step in adsorptive pinocytosis (endocytosis) whereby receptors on the cell surface bind extracellular macromolecular ligands with high, (though not absolute) specificity and deliver them to the lysosomal compartment. Receptor mediated endocytosis systems have been described for substances as diverse as low density lipoproteins, vitamin B<sub>12</sub>, hormones, growth factors, blood plasma glycoproteins and hydrolytic enzymes.

Cells of diverse forms and functions regulate receptor mediated pinocytosis in a subtle way a) to retrieve and assimilate molecules present in their immediate environment at very low concentration, and b) to clear certain molecules from the circulation. Receptor mediated endocytosis appears to be carried out by differentiated regions of the plasma membrane referred to as 'coated pits'<sup>143,144</sup>.

In the group of circulating glycoproteins and hydrolytic (lysosomal) enzymes pinocytosis involves the presence of carbohydrate binding cell surface receptors and specific carbohydrate residues in the internalized molecules that are recognized by membrane bound receptors. There are 5 well defined pinocytotic systems, the specificity of which results from the recognition of particular carbohydrate sequences in the glycoprotein to be pinocytosed by complementary sites on receptor proteins of the cell surface (table 4).

*Galactose recognition system in mammalian hepatocytes:* In 1966 Ashwell, Morell and their co-workers<sup>235</sup>

observed that removal of sialic acid from blood plasma glycoproteins (e.g. ceruloplasmin) by neuraminidase leads to a dramatic enhancement of their clearance rate from the circulatory system of rabbit, rat and dog. The removal of as few as 2 sialic acid residues per molecule of ceruloplasmin (out of a total of about 10) is sufficient to reduce the half life of the glycoprotein in the circulation from 54 h to 3-5 min. The asialoglycoproteins are rapidly taken up and catabolized by the liver. The binding protein that was presumed to be responsible for this reaction was purified from rabbit liver<sup>236,237</sup>. Uptake depends on the recognition by liver parenchymal cells (hepatocytes) of terminal galactose residues on the glycoproteins. In many sialoglycoproteins galactose occupies the preterminal position in the oligosaccharide moiety and is exposed upon removal of the sialic acid by neuraminidase.

The purified galactose binding protein agglutinates human or rabbit erythrocytes<sup>238</sup> (which led to its designation as a lectin of mammalian origin). Another property that it shares with some plant lectins is induction of mitosis in peripheral lymphocytes<sup>239</sup>. Like many other lectins the galactose binding protein has a fairly broad saccharide binding specificity. *α*-methyl-*N*-acetyl-*α*-D-galactosaminide has a higher affinity than the corresponding galactoside<sup>240</sup>.

Although the galactose binding protein in liver parenchymal cells (galactose receptor) appears to exert its biological function at the plasma membrane, only about 5% ( $7 \times 10^4$  molecules pro hepatocyte) is found at this site<sup>241</sup>. About 95% of the galactose binding protein of rat hepatocytes is localized intracellularly in association with the Golgi complex, smooth microsomes and lysosomes<sup>242</sup>. A rather surprising finding is that most of the receptor activity associated with lysosomes appears to be oriented on the cytoplasmic surface of the membrane, in contrast with the other organelles in which it appears to be localized at the luminal surface<sup>242</sup>.

*Fucose recognition system in mammalian hepatocytes:* A clearance system of mouse liver based on the recognition of terminal non-reducing L-fucose has been described<sup>243</sup>. The receptor binds glycoprotein (e.g. lactoferrin) specifically through fucose linked

Table 4. Carbohydrate specific recognition systems for receptor mediated pinocytosis (for references see text)

Cell type	Specificity of cell surface receptor	Ligands recognized by receptor (examples)
Mammalian hepatocytes	Galactose ( $\beta$ -galactosyl-)	Blood plasma asialoglycoproteins
Mammalian hepatocytes	$\alpha$ -Fucosyl (1 → 3)	Lactoferrin, fucosylated asialotransferrin
Avian hepatocytes	N-Acetylglucosamine	Agalactoorosomuroid
Human fibroblasts	Mannose-6-phosphate	Lysosomal enzymes (e.g. $\beta$ -hexosaminidase, $\beta$ -glucuronidase)
Mammalian RES cells	Mannose/N-acetylglucosamine	Lysosomal enzymes (e.g. $\beta$ -glucuronidase, $\beta$ -Galactosidase, $\beta$ -hexosaminidase), agalactoorosomuroid

$\alpha(1 \rightarrow 3)$  to *N*-acetylglucosamine.  $^{125}\text{I}$ -Lactoferrin injected i.v. into mice and rats was rapidly cleared from the circulation. 25 min after injection 98% of the radioactivity was recovered in the isolated hepatocytes. 1% was found in the sinusoidal cells. Partial destruction of the carbohydrate moiety of lactoferrin by exposure to periodic acid or extensified hydrolysis with mixed glycosidases markedly reduced the rate of clearance from serum. Glycopeptides isolated from lactoferrin inhibited uptake of the intact molecule. Fucoidin which contains some  $\alpha(1 \rightarrow 3)$  linked fucose significantly prolonged the clearance of injected  $^{125}\text{I}$ -lactoferrin, while a variety of macromolecules exposing terminal galactose, mannose or *N*-acetylglucosamine residues were without effect.

*N*-Acetylglucosamine recognition system of avian hepatocytes: In the avian liver the galactose binding protein which had been described in mammalian liver is absent. The avian liver, however, contains a binding protein specific for terminal *N*-acetylglucosamine residues in glycoproteins. This protein will bind glycoproteins with complex oligosaccharides from which both the terminal nonreducing sialic acid and the penultimate galactose had been removed to expose the underlying hexosamine moiety<sup>244</sup>. Glycoproteins with non-reducing  $\beta$ -galactosyl or  $\alpha$ -mannosyl groups do not bind to the avian liver receptor.

The avian *N*-acetylglucosamine binding receptor protein has many properties in common with the mammalian galactose binding protein as it requires calcium for the binding reaction, it is a glycoprotein, it tends to aggregate in aqueous solution and is inactivated by the action of  $\beta$ -galactosidase and neuraminidase, respectively.

*Mannose-6-phosphate recognition system in human fibroblasts*: The existence of a receptor mediated system in cultured human fibroblasts for the uptake of lysosomal enzymes was discovered in E.F. Neufelds laboratory (for review see reference 245) as a result of studies on genetic disorders of mucopolysaccharide catabolism. Uptake of lysosomal enzymes depends on mannose-6-phosphate terminated oligosaccharide side chains in these enzymes<sup>220-223</sup> and on specific receptors on the cell surface of fibroblasts<sup>246,247</sup>. For biosynthesis of this unusual glycan, see Part 3.

In cultured cells the mannose-6-phosphate recognition system of lysosomal enzymes appears to fulfill 2 functions: in pinocytosis of extracellular enzymes and in intracellular transport of newly synthesized enzymes from the Golgi apparatus to lysosomes. This is indicated by the following observations<sup>219-224,248-251</sup>:

a) Following alkaline phosphatase treatment of enzymes bearing the mannose-6-phosphate recognition marker (high uptake form) they are converted to less

acidic (low uptake) enzyme forms that were not longer susceptible to pinocytosis<sup>219,248-250</sup>.

b) Endoglucosaminidase H, an enzyme that cleaves high mannose oligosaccharides abolishes the uptake of lysosomal enzymes by fibroblasts<sup>220,221</sup>.

c) ( $^{32}\text{P}$ )Phosphate is incorporated into newly synthesized acid hydrolases from normal fibroblasts but not into newly synthesized acid hydrolases from I-cell (mucopolidosis II) fibroblasts<sup>252</sup>. In the absence of the mannose-6-phosphate recognition marker the enzymes of I-cells fail to be segregated and proceed through the Golgi where their oligosaccharides are processed to the complex type. Because the I-cell enzymes that lack the recognition marker, are not receptor bound, they are released from the cells to the extracellular space and the secretory vesicles fuses with the plasma membrane<sup>224,253,254</sup>.

d) Membranes from I-cell fibroblasts are deficient in *N*-acetylglucosaminyl-1-phosphate transferase<sup>225,233</sup>. How the mannose-6-phosphate marker may influence intracellular transport of lysosomal enzymes, is depicted in figure 14.

*Mannose/N-acetylglucosamine recognition system*: Purified lysosomal glycosidases and various glycoproteins following i.v. infusion are rapidly cleared from blood plasma<sup>255</sup>. Although the liver is primarily responsible for this clearance, macrophages and cells of the reticuloendothelial system (e.g. Kupffer cells, endothelial cells, spleen and bone marrow cells) also mediate clearance. Recognition of lysosomal enzymes by macrophages in vitro is sugar specific and rapid clearance is impaired by the simultaneous administration of mannose- or *N*-acetyl-glucosamine-terminated glycoproteins<sup>256</sup>. It was therefore concluded, that the lysosomal glycosidases are recognized by a cell surface mannose/*N*-acetylglucosamine receptor of macrophages and that terminal mannose and *N*-acetylglucosamine are common features of lysosomal enzymes.

Beside lysosomal enzymes and other natural glycoproteins, mannose and *N*-acetylglucosamine coupled to bovine serum albumine (BSA) were among the best ligands when isolated rat macrophages were used as test system. For mannose-BSA the maximum velocity of uptake was approximately 300,000 molecules/min/cell.  $\text{Ca}^{2+}$  was required for binding<sup>257</sup>.

The function of the mannose/*N*-acetylglucosamine receptor is linked to the lysosomal system and the transport of lysosomal enzymes, principally because many lysosomal enzymes express the recognized terminal sugar. Stahl and Schlesinger<sup>258</sup> discuss at least 3 sites where the mannose/*N*-acetylglucosamine receptor might function: a) intracellular recognition and transport of newly synthesized lysosomal hydrolases within the endoplasmic reticulum; b) within coated vesicles to retain enzymes and prevent their loss to the extracellular compartment; c) as a retrieval system for



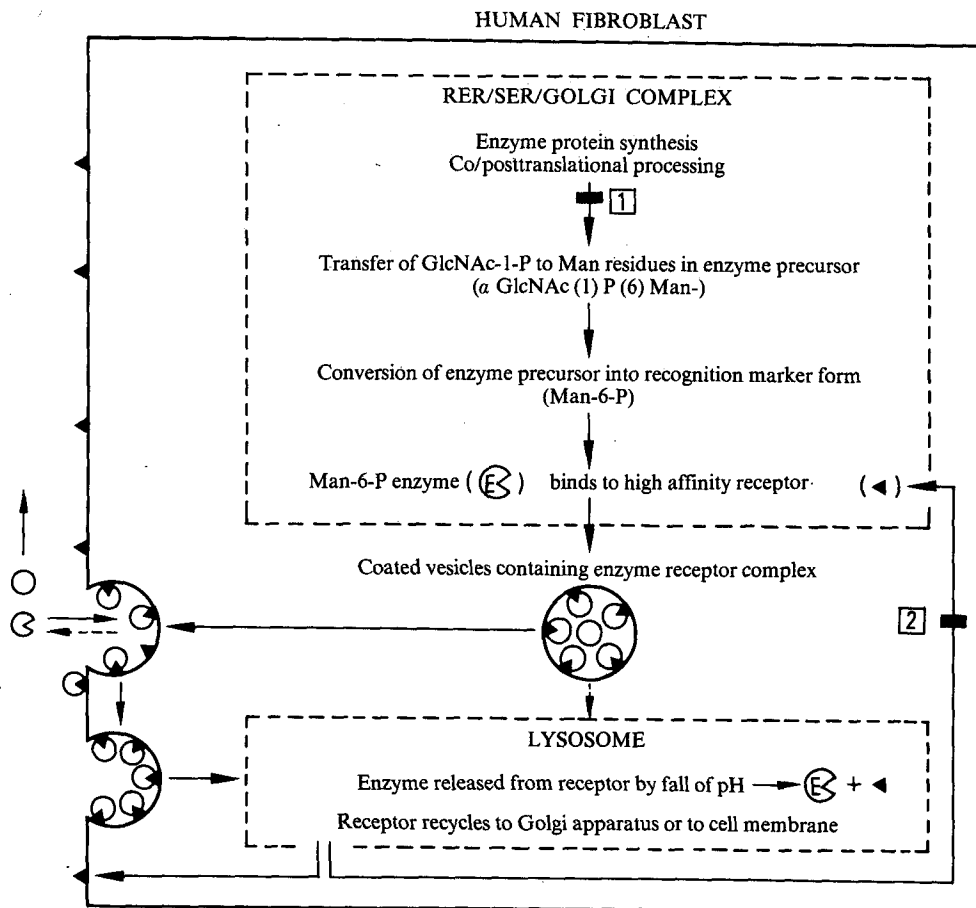

Figure 14. Schematic presentation of synthesis, processing and intracellular transport of lysosomal enzymes in human skin fibroblasts. Denotes metabolic blocks in mucopolidosis II [I-cell disease, (1)] and by treatment the cells with chloroquine or basic amines (2). For references see von Figura and Weber<sup>292</sup>, Hasilik et al.<sup>254</sup> and Sly et al.<sup>293</sup>.

lysosomal enzymes which, for various physiological or pathological reasons, make their way into extracellular space; clearance from circulation will prevent damage to surface lining the blood vessels; d) a fundamental function has been suggested for immunological reactions. Serum immunoglobulins possess asparagine-linked oligosaccharides with terminal mannose residues, that become more exposed after binding of the immunoglobulin to antigen. This may be an adequate signal for rapid clearing of the antigen-antibody complex from the blood by specific binding to the macrophage receptor<sup>259</sup>. In addition the macrophage mannose residues on the surface of macrophages might function in an antibody-independent reaction by direct binding and phagocytosis of potentially pathogenetic organism, such as yeast<sup>260</sup> which express surface mannose specific lectin structures.

*Carbohydrates on cell surface*

In addition to their ability to serve as recognition markers of various biologically active molecules, cell surface sugars serve as recognition markers in cell-cell, cell-virus and cell-bacteria interactions. Moreover, cell surface glycoproteins are the immunodeterminant structures of blood group A, B, H and

M/N specificities or act as acceptors for a number of lectins, and are involved in cell adhesion and presumably play a structural role in stabilizing the cell membrane (table 5).

Table 5. Carbohydrates on cell surfaces serving as attachment sites for biological agents. From Sharon and Lis<sup>234</sup>

Agent	Sugar determinant (attachment site)
Antibodies	
Blood type A	<i>α</i> -GalNAc
Blood type B	<i>α</i> -Gal
Blood type 0	<i>α</i> -L-Fuc
Fibronectin	NeuAc-Gal-GlcNAc-Gal
Lectins	
Concanavalin A, lentil lectin	Man, Glc
Peanut agglutinin	Galβ1 → 3GalNAc
Lima bean and soybean agglutinins	GalNAc
Limulin, wheat germ agglutinin	NeuAc
Potato and wheat germ agglutinins	(GlcNAc) <sub>1-3</sub>
Lymphokines	
<i>α</i> -Interferon	NeuAc-Gal-GalNAc
Leukocyte inhibitory factor	GlcNAc
Migration inhibitory factor	L-Fuc
Toxins	
Abrin, ricin	Gal
Botulinus, cholera, tetanus	(NeuAc) <sub>0,1</sub> -Gal-GalNAc
Viruses	
Influenza, Sendai	NeuAc

**Cell-cell interactions:** A good example of intracellular recognition and adhesion is the sexual mating of compatible yeast. Opposite types (type 5 and type 21) of haploid cells of *Hansenula wingei* are coated by substances that causes their immediate aggregation upon mixing, a reaction that facilitates mating. These substances have been purified and extensively characterized. Type 5 factor is a glycoprotein containing 85% mannose and only 10% protein and consists of a central core to which about 6 small glycoprotein subunits are attached by disulfide bonds. The subunit contained the specific receptors that bind the type 21 factor. Type 21 factor is a small acidic glycoprotein that contains 5% carbohydrate and is complementary to the receptor of type 5 factor involving a determinant depending on both carbohydrate and peptide structures (for review see reference 261).

The fertilization of *Fucus serratus* – a brown alga – is based on the association between mannosyl and L-fucosyl residues on the egg surface and specific carbohydrate binding ligands on the sperm surface. This has been concluded from the fact that binding of polysaccharides containing mannosyl or L-fucosyl residues to sperm or by treatment of eggs with  $\alpha$ -mannosidase or  $\alpha$ -L-fucosidase inhibits fertilisation<sup>262</sup>.

Studies on the differentiation of the slime mold *Dictyostelium discoideum* from a vegetative (single cell) to a cohesive (aggregated) form revealed that the cellular association is mediated by the interaction between carbohydrate binding protein on one cell and specific oligosaccharide receptors on an opposing cell<sup>263</sup>, the latter reacting with lectins specific for galactose and *N*-acetylgalactosamine<sup>264</sup>.

In analogy to the role of carbohydrates in determining the survival time of glycoproteins in the circulation system, sugars on cell surfaces may be important in determining the life span to circulating cells and the distribution in specific organs in the body. Thus, human erythrocytes which normally persist in the circulatory system for about 120 days are absorbed within hours and phagocytosed by liver Kupffer cells and by spleen macrophages after treatment with neuraminidase<sup>265</sup>. This observation has led to the assumption that the decrease in sialic acid and exposure of subterminal galactose is correlated with a physiological mechanism of erythrocyte senescence and thereby the signal responsible for the removal of the older erythrocytes from the circulation. It has been found, however, that the decreased content of sialic acid in old erythrocytes is due to a loss of intact glycoprotein molecules rather than of sialic acid alone<sup>266</sup>. Moreover, galactose specific peanut agglutinin interacted with desialylated human erythrocytes that expose terminal galactose residues but did not bind to old erythrocytes<sup>267</sup>. Therefore it seems more likely that sialic acid protects erythrocytes from clear-

ance and sequestration not by covering an internal galactose marker but by preventing the binding of immunoglobulines and the subsequent uptake into macrophages mediated by the Fc receptor<sup>268</sup>.

Similar experiments have been made with rat lymphocytes. Native cells after injection are homing to the spleen, but after treatment with glycosidases they migrate to the liver instead<sup>269</sup>.

**Cell-virus and cell-bacteria interaction:** The first indication that sugars serve as specific determinants for binding of microorganism to eucaryotic cells came from the discovery that the influenza virus binds to erythrocytes through sialic acid units of the cell surface resulting in an agglutination of red cells. Removal of sialic acid from the cell surface by neuraminidase abolishes this effect. The conclusion that sialic acid is a receptor for influenza virus was supported by the observation that agglutination is inhibited by very low concentrations of soluble sialoglycoproteins and that the latter lose their inhibitory activity upon desialylation<sup>270</sup>.

Cell surface saccharides act as receptors not only for viruses but also for bacteria. The importance of this phenomenon is evident from the fact that the adherence of bacteria to tissue surfaces is the initial event in a bacterial infection. It was demonstrated that bacteria such as *Escherichia coli* and *Salmonella typhimurium* adhere to epithelial cells and to scavenge white blood cells through units of mannose on the surface of such cells<sup>271</sup>. This carbohydrate specific interaction is mediated by a mannose-specific lectin present on the surface of the bacteria<sup>272</sup>. Methyl- $\alpha$ -mannoside effectively inhibits the mannose specific adherence of the bacteria to epithelial cells. This explains why the colonization of the urinary tract of mice infected with *E. coli* can be markedly diminished by the administration of methyl- $\alpha$ -mannoside. The therapeutical implication of this experiment lies in the possibility that such inhibitors might serve to prevent bacterial infection by blocking its first step, the adherence of the invading organism to epithelial surfaces of the host<sup>273</sup>.

**Surface glycoproteins and cell adhesion:** Many types of mammalian cells have the ability to adhere to each other and to various natural or artificial substrates. The adhesive properties are considered essential to normal morphogenesis and differentiation and manifest themselves in markedly selective cell aggregation phenomena in vitro. Complex carbohydrates, especially fibronectin, that represents the major glycoprotein of the cell surface in fibroblasts is believed to play a role in cell-cell and cell-substratum adhesion, in cellular morphology, growth and malignant transformation<sup>274,175</sup>.

Several ricin-resistant variants of hamster fibroblasts (BHK-cells) have identifiable deficiencies in glycosyltransferases responsible for assembly of the carbohy-

drate chains of cell surface glycoproteins<sup>276</sup>. These ricin-resistant cell lines showed reduced cell-cell and cell-substratum adhesiveness and, in general, lack surface exposed fibronectin. Sugars on the surface of many lectin-resistant cell lines are different from those of the normal parent cells. Several results support a role for cell surface carbohydrate groups in binding fibronectin to fibroblast and inducing these cells to adhere to substrate (e.g. collagen) and possibly to other cells<sup>277</sup>. Malignant transformation of cells results in disappearance of fibronectin from the cell surface in addition to a remarkable shift in their surface carbohydrate pattern.

#### *Glycoproteins as cell surface structural components:*

The basic structure of all cell membranes is the lipid bilayer with associated and integral membrane proteins. In addition peripheral components stabilize the membrane by increasing the rigidity of the bilayer. Eucaryotes have an internal cytoskeletal system of microtubuli and microfilaments which interact with the surface of the membrane affecting cell shape, motility and influencing the mobility of the membrane proteins. Eubacteria have external components in particular peptidoglycans (murein) which maintain cell shape and rigidity.

The archbacteria have neither a cytoskeletal system nor peptidoglycans, but one member of this group, *Halobacterium salinarium* has a cell surface glycoprotein which appears to play a structural role in stabilizing the membrane and maintaining cell morphology<sup>278</sup>. About 50% of the carbohydrates present in the cell envelope of *Halobacterium salinarium* is in form of a high molecular weight glycoprotein and exposed at the cell surface. The protein moiety of the glycoprotein accounts for about half of the total envelope protein and forms a rigid matrix at the cell surface, that is responsible for maintenance of cell shape. These organisms are rod-shaped under normal growth conditions, despite the absence of the peptidoglycan layer necessary for the maintenance of shape in most other bacteria<sup>279</sup>.

Growth of the cells in bacitracin, an antibiotic which blocks the lipid intermediate pathway for glycosylation, for approximately one doubling time, resulted in a 40–50% decrease in the amount of carbohydrate attached to the glycoprotein and simultaneously in a complete conversion from rod-shaped to spherical cells<sup>280</sup>. The non-glycosylated polypeptide continued to be synthesized and placed at the cell surface. No changes in other membrane proteins, lipids or glycolipids could be detected. These results support the conclusion that the glycoprotein forms a rigid structural matrix at the surface of the cells and is responsible for maintenance of the characteristic rod-shaped morphology.

In multicellular organisms many examples of structural glycoproteins (e.g. collagen and basement mem-

brane) are known. While the structural role of such extracellular glycoproteins is clear, it is not known if any of the cell surface glycoproteins increases the stability of the cell membrane.

It has been suggested<sup>281</sup> that the major sialoglycoprotein (glycophorin) of erythrocytes might function in this manner with the carbohydrate residues interacting to form a lattice over the internal cell membrane and providing the membrane with greater rigidity. Removal of the sialic acid from the cell surface glycoproteins of sarcoma 37 and Ehrlich murine ascites tumor cells<sup>278</sup> results in an increased ability of the cell membrane to be deformed. For the fibronectin present on normal fibroblast membranes a function of an exoskeleton on the cell surface has been suggested which retards the mobility of other membrane proteins.

A shortcoming in experiments designed to demonstrate a structural role for animal cell surface glycoproteins is the fact that many of these glycoproteins may be involved in interactions with cytoskeletal components at the inner surface of the membrane. Thus, changes in cell shape, ability to be deformed, mobility etc. following alterations of surface glycoproteins cannot necessarily be attributed to the altered glycoprotein structure but may result from concomitant changes in the cytoskeletal system.

#### *Physicochemical and biological properties*

*Protein folding and stabilizing protein conformation:* Oligosaccharide chains can influence the ability of protein to fold properly. The cotranslational transfer of an oligosaccharide residue having the structure  $\text{Glc}_3\text{Man}_9\text{GlcNAc}_2$  to an asparagine residue of a polypeptide during the synthesis in the endoplasmic reticulum may be essential for the protein to achieve the correct tertiary structure.

The concept that oligosaccharides influence the conformation of a protein being synthesized is supported by results of inhibition of glycosylation. Beside sugar analogues (e.g. deoxyglucose, fluoroglucose and fluoromannose<sup>282</sup>) and a few antibiotics, mainly tunicamycin – a nucleoside antibiotic produced by *Streptomyces lysosuperficus* – has been used as an inhibitor of glycosylation. Tunicamycin blocks formation of *N*-acetylglucosaminyl pyrophosphodolichol thereby preventing the synthesis of any of the oligosaccharides normally transferred to asparagine residues<sup>283</sup>.

The importance of glycosylation for protein folding and assembly may be exemplified by the synthesis of one specific virus glycoprotein – the G-protein of vesicular stomatitis virus (VSV), first described by Gibson, Kornfeld and Schlesinger<sup>284</sup>. VSV replicates in a wide variety of animal cells. In the course of virus multiplication the G-protein is synthesized on a membrane-bound ribosome of the host cell, inserted into the membrane of the endoplasmic reticulum and is

glycosylated by host cell enzymes during translation. Thence, it is transported to the cell surface where the virions are assembled. Tunicamycin strongly inhibited virion production. The G-protein was synthesized in normal amounts, but was not transported to the outer surface of the infected cell plasma membrane. It was, however, found in the cells in a form that could only be solubilized by guanidinium chloride. These data led to the proposal that for the G-protein in VSV, oligosaccharides play a key role during folding of the polypeptide<sup>284</sup>.

Comparing 2 strains of VSV (San Juan and Orsay) containing different, but related G-proteins it was found that the viral proteins synthesized at elevated temperatures in the presence of tunicamycin were temperature sensitive and underwent aggregation and that different proteins may have different requirements for covalently found carbohydrates in order to assume the proper conformation. An additional finding was that the glycosylated and nonglycosylated virions have the same specific infectivity demonstrating that the oligosaccharide chains on the G-protein are not essential for the infectivity of the virus.

Tunicamycin and other glycosylation inhibitors have been used to study other functions of the carbohydrate portion of glycoproteins. In particular their influence on secretion of proteins, susceptibility to proteolytic degradation and enzyme activity was investigated. In most of these systems the results have been somewhat conflicting and have made it difficult to find a unifying hypothesis. Table 6 gives some examples illustrating that the effects of tunicamycin on different glycoproteins are diverse<sup>167,284</sup>.

The concept that carbohydrates act in stabilizing the glycoprotein against denaturation and proteolytic

degradation<sup>284a</sup> supported by the finding that chemical attachment of dextran chains to lysozyme, trypsin and chymotrypsin increased the stability of the enzymes to inactivation by proteolysis. On the other hand, the available information shows clearly that the presence of carbohydrate is not always essential for the particular function of the glycoprotein in which it occurs. Moreover, the fact that bacteria - with a few exceptions - do not contain any glycoproteins implies that some of the biological functions of carbohydrates may also be performed by other constituents<sup>234</sup>.

*Viscosity and water binding capacity:* Studies with the sialic rich glycoproteins of saliva and intestinal, tracheal or cervical mucus have led to the conclusion that the sialic acid is responsible for the high viscosity and the function of those mucins as lubricants. Because of the low pK values of the sialic acid, its carboxyl group is dissociated at physiological pH's. The high density of negatively charged carboxyl groups thus present in mucin molecules imparts to them an extended rod-like polyelectrolyte structure. The space-filling character of these molecules gives rise to the formation of viscoelastic gels, often with anisotropic properties. In some cases, however, removal of sialic acid of sialoglycoproteins did not affect the physicochemical properties (e.g. viscoelasticity).

The antifreeze glycoprotein of antarctic fish has the ability to depress the freezing point of water. The antifreeze activity depends on the integrity of the disaccharide units that form hydrogen bonds with water molecules, thus preventing the growth of ice crystals (for review see reference 285). In contrast to antarctic fish, the serum of arctic fish contains non-

Table 6. Examples of the effect of inhibiting glycosylation with tunicamycin on the synthesis of glycoproteins. Modified from Gibson et al.<sup>167</sup>

Biological operation	Product of synthesis	Effect of inhibiting glycosylation
Incorporation into membranes	G Protein of VSV (San Juan)	Nonglycosylated protein aggregates when synthesized at 38 °C, not incorporated into surface membrane
	G Protein of VSV (Orsay)	Nonglycosylated protein functions normally when synthesized at 30 °C
	Glycoprotein of Sindbis virus Glycoprotein of Semliki Forest virus Glycophorin A	Precursor glycoprotein is not cleaved Nonglycosylated protein does not reach outer cell surface Incorporated normally into surface membrane
Secretion	IgM of mouse plasmocytoma cell	81% Inhibition of IgM secretion
	IgM of murine myeloma cell line	No effect on secretion of IgM
	Fibronectin (chicken embryo)	No effect on synthesis or localisation
	Procollagen (chicken embryo)	No effect on synthesis or localisation
	Procollagen (human skin fibroblasts)	Inhibition of secretion
	Human immune interferon	No effect on secretion or biological activity
Enzyme activity	Transferrin	No effect on secretion
	Apolipoprotein B	No effect on secretion
	Invertase (yeast)	Inhibition of active enzyme formation
Proteolytic degradation	Acid phosphatase (yeast)	Inhibition of active enzyme formation
	Alkaline phosphatase (yeast)	No effect on enzyme activity
Proteolytic degradation	Fibronectin (chick embryo)	More sensitive to proteolytic degradation
	Hemagglutinin (influenza virus)	More sensitive to proteolytic degradation

glucosylated proteins with antifreeze activity, that are characterized by a high alanine and aspartic acid content<sup>286</sup>.

*Binding properties of proteoglycans and glycosaminoglycans:* Proteoglycans are characteristic components of the extracellular matrix of connective tissue and along with the fibrous proteins collagen and elastin the major macromolecular elements of connective tissue. The physicochemical properties and the supra-molecular structure of connective tissues are closely related not only to the capability of these components to bind water and microions but also to a diverse pattern of binding between macromolecules including polysaccharide-protein and polysaccharide-polysaccharide interactions. The characteristics and specificity of such interactions have been studied in some cases in detail but in most instances binding has not been demonstrated but has been inferred from functional observations. Table 7 gives some examples<sup>172</sup>.

Cartilage proteoglycans form large aggregates in which many monomers of proteoglycans subunits ( $1-4 \times 10^6$ ) bind to macromolecular hyaluronic acid through a highly specific interaction mediated by the hyaluronate binding region located at one end of the core protein of each proteoglycan monomer. The active site of this reversible interaction extends over 10 monosaccharides of hyaluronic acid. The hyaluronate binding region of the proteoglycan is located in a protein core fragment with molecular weight in the order of 60,000–70,000. Arginine residues of the hyaluronate binding region of proteoglycan monomers were found to be necessary for interaction. The interaction between the proteoglycan and hyaluronate becomes effectively irreversible in the presence of link proteins (link protein I or 2) which interact with both hyaluronic acid and the hyaluronic acid binding region of proteoglycan monomers (fig. 15). The active binding site in the link protein and the hyaluronate binding region in the monomer are bound to a region of hyaluronate consisting of 25–30 monosaccharides (for review, see reference 287). Thus, it appears that the three aggregate components all possess 2 binding

sites, interacting with the other 2 components<sup>288</sup>. In addition self interactions between the proteoglycan monomers and between the link proteins have been demonstrated<sup>289</sup>.

In the group of glycosaminoglycans heparin presents a rather interesting case of interaction. It is synthesized and stored within mast cells in the close vicinity of blood vessels and released from mast cells in certain situations. The blood anticoagulant activity of heparin depends on its ability to bind with high affinity to antithrombin, a plasma protein that inhibits the proteases involved in the coagulation mechanism. An octasaccharide sequence of the heparin molecule (fig. 16) represents the majority of high affinity antithrombin binding capacity. The actual antithrombin binding region is contained within the pentasaccharide sequence 2–6. The 2 *N*-sulfate groups at position 4 and 6, the 6-*O*-sulfate group at position 2 and – as a unique component – a 3-*O*-sulfate group at position 4 are all of crucial importance and essential to the anticoagulant action of heparin<sup>290</sup>.

#### Concluding remarks

Many biological functions are attributed to the heteroglycan moiety of glycoproteins and proteoglycans. In view of the stability of pathways of glycosylation in a wide range of species it is likely that glycosylation of proteins was an early event in evolution of higher organisms with a highly selective advantage. Glycosylation of proteins is an expensive operation requiring genetic information for the production of many enzymes, substrates and cofactors. This suggests an important function of heteroglycans, otherwise it would not have persisted throughout evolution.

The high mannose form of glycoproteins may be a primitive form of oligosaccharide playing a role in initial folding of proteins being synthesized and stabilizing their conformation. The evolution of an oligosaccharide processing pathway can be considered as a means to expand the repertoire of carbohydrate structures and, hence, their biological roles. The concept that carbohydrates serve as recognition markers both

Table 7. Interaction of proteoglycans or glycosaminoglycans with extracellular or intracellular components. Compiled from Lindahl and Höök<sup>291</sup>

Proteoglycan/ glycosaminoglycan	Interacting component	Function (result of interaction)
Proteochondroitin sulfate } Proteodermatan sulfate }	Collagen type I, III > II	Extracellular fibrillogenesis
Hyaluronate (HA)	Protein core (HA binding region) of proteochondroitin sulfate	Formation of extracellular proteoglycan aggregates
Hyaluronate (HA)	Link protein I, II	Stabilizing proteoglycan aggregates (formation of proteoglycan complexes)
High affinity heparin	Antithrombin III	Anticoagulant
Proteochondroitin sulfate	Platelet factor 4	Neutralisation of heparin effect
Heparin	Lipoproteinlipase, hepatic lipase	Release of lipases into circulation

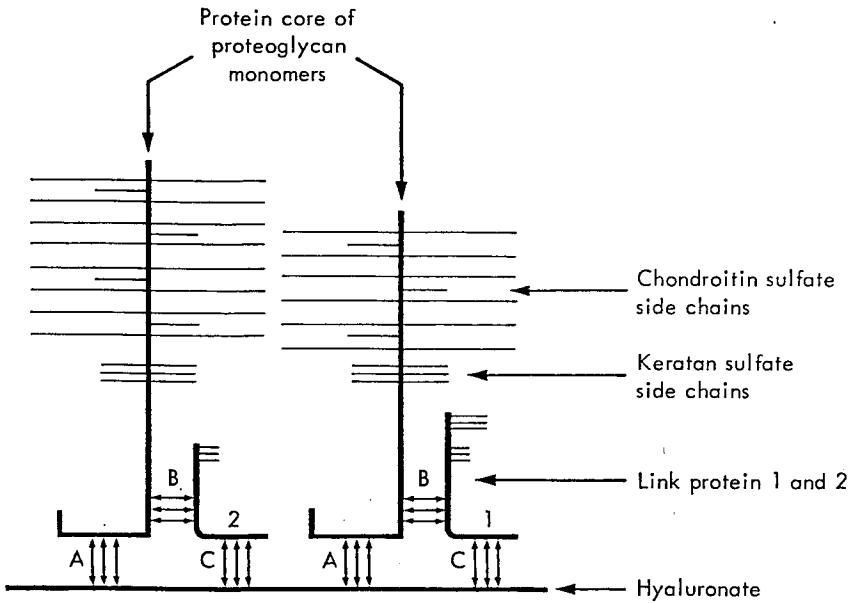

Figure 15. Interaction between the components of proteoglycan aggregates: (A) between proteoglycan monomers and hyaluronate; (B) between proteoglycan monomers and link proteins 1 and 2; (C) between link proteins 1 and 2 and hyaluronate. From Caterson and Baker<sup>288</sup>.

on soluble glycoproteins and cell surfaces offers many opportunities for further development with increasing implications for medicine: Thus, the diagnosis and correction of genetic disorders of carbohydrate metabolism, the attachment of sugars to enzymes or proteins in order to stabilize them to control their life span in circulation and direct them to target organs could be of practical benefit. Coupling drugs to recognition markers of carbohydrate nature appears to be a promising tool for targeting drugs to specific sites in the body and antisera against bacterial cell surface lectins could be used in the prevention of infections.

No doubt, future progress in this area will confirm the concept of carbohydrates as information bearing molecules.

### Summary and perspectives

This review covers structure, structural analysis, biosynthesis and functions of glycoprotein glycans. In the 1st part, representative structures of *N*- and *O*-glycosidic glycans found in animal glycoproteins are described. The 2nd part deals with methodology used to elucidate structures of heteroglycans: it includes procedures for isolation of pure oligosaccharides amenable to structural analysis and procedures for identification of the type, substitutions and anomeric configurations of individual glycoside units. Most importantly, the use of high resolution NMR spectroscopy is described for the elucidation of the structure of complex glycans and also for the identification of glycosyltransferase reaction products formed *in vitro*. The 3rd part, devoted to biosynthesis, gives a short description of essential features of glycosyltransferases emphasizing their rigorous specificities which form the basis of the still undisputed 'one enzyme

(glycosyltransferase)-one (glycosidic) linkage' concept. Biosynthetic pathways of the *O*-glycosidic glycans are described which consist exclusively of sequential transfer of single glucose units to form glycan chains. *N*-glycosidic glycans, in contrast, are synthesized in two stages: first, by *en bloc* transfer to the nascent polypeptide chain of a lipid-linked oligosaccharide precursor and its processing to a small oligosaccharide core unit, before, in a second stage, final glycosylation by sequential addition of peripheral glycoside units takes place in the Golgi apparatus.

In the 4th part, well established functions of glycan moieties are described, the most prominent being their involvement in recognition and their importance in protein folding and stabilization of the cell membrane. Two examples of biological recognition, the galactose binding system on mammalian hepatocytes and the mannose-6-phosphate recognition system for lysosomal enzymes are discussed in detail.

Considerable progress has been made in analyzing structure and function of glycans. However, long standing observations such as microheterogeneity, presence of blood group antigens on cell surfaces and increased lectin agglutinability of transformed cells (for review see reference 294) remain puzzling. Refined techniques in structural analysis, as outlined in the second part, will continue to provide new information on oligosaccharide structure, and perhaps lead to the identification of hitherto unknown glycosyltransferase activities. In addition, phosphorylation (see Part 3) and sulfation of glycoprotein glycans as recently detected in pituitary hormones<sup>295,296</sup> will raise new questions concerning biosynthesis and function of glycans. The powerful affinity purification techniques established for various glycosyltransferases have opened up new perspectives: The availability of monospecific antibodies makes possible studies on

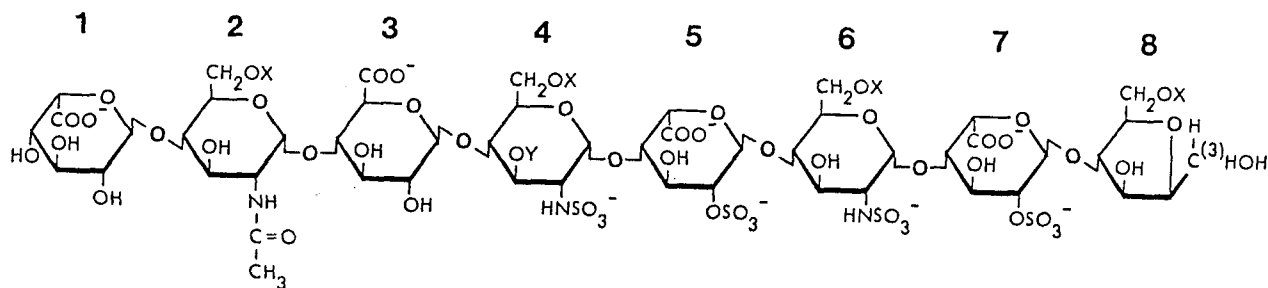

Figure 16. Structure of an antithrombin-binding octasaccharide derived from pig mucosal heparin. X is either a hydrogen atom or a sulfate group. Y on the glucosamine residue in position 4 has been identified as a sulfate group. The actual antithrombin binding region is contained within the pentasaccharide sequence 2-6. From Lindahl et al.<sup>290</sup>.

biosynthesis and maturation<sup>297</sup> and, ultimately, may pave the way for studies on gene expression of glycosyltransferases. Finally, new model systems, such as lectin-resistant cell lines which show altered adhesive properties (for review see reference 298), may increase our understanding of cell surface glycan functions.

References

- 1 Gottschalk, A., *Glycoproteins*. BBA Library, vol.5. Elsevier, Amsterdam 1972.
- 2 Gesner, B.M., and Ginsburg, V., *Proc. natl Acad. Sci. USA* 52 (1964) 750.
- 3 Hakomori, S.-I., *A. Rev. Biochem.* 50 (1981) 733.
- 4 Horowitz, M.I., and Pigman, W., eds, *The Glycoconjugates*. Academic Press, New York and London 1977.
- 5 Lennarz, W.J., ed., *The Biochemistry of Glycoproteins and Proteoglycans*. Plenum Press, New York and London 1980.
- 6 Gregory, J.D., and Jeanloz, R.W., eds, *Glycoconjugate Research. Proc. 4. Int. Symposium on Glycoconjugates*, Academic Press, New York and London 1979.
- 7 Schauer, R., Boer, P., Buddecke, E., Kramer, M.F., Vliegthart, J.F.G., and Wiegandt, H. eds, *Glycoconjugates. Proc. 5. Int. Symposium on glycoconjugates*. Thieme, Stuttgart 1979.
- 8 Yamakawa, T., Osawa, T., and Handa, S. eds, *Glycoconjugates. Proc. 6. Int. Symposium on Glycoconjugates*. Jap. scient. Soc. Press, Tokyo 1981.
- 9 Spiro, R.G., *Meth. Enzymol.* 28 (1972) 3.
- 10 Kobata, A., *Analyt. Biochem.* 100 (1979) 1.
- 11 Nilsson, B., Nordén, N.E., and Svensson, S., *J. biol. Chem.* 254 (1979) 4545.
- 12 Takasaki, S., Mizuochi, T., and Kobata, A., *Meth. Enzymol.* 83 (1982) 263.
- 13 Gottschalk, A., Bhargava, A.S., and Murty, V.L.N., in: *Glycoproteins*, p.810. Ed. A. Gottschalk. Elsevier, Amsterdam 1972.
- 14 Bahl, O.P., *J. biol. Chem.* 244 (1969) 575.
- 15 Thomas, D.B., and Winzler, R.J., *J. biol. Chem.* 244 (1969) 5943.
- 16 Baenziger, J., and Kornfeld, S., *J. biol. Chem.* 249 (1974) 7270.
- 17 Shier, W.T., Lin, Y., and De Vries, A.L., *FEBS Lett.* 54 (1975) 135.
- 18 Endo, Y., Yamashita, K., Han, Y.N., Iwanaga, S., and Kobata, A., *J. Biochem., Tokyo* 82 (1977) 545.
- 19 Takasaki, S., Yamashita, K., and Kobata, A., *J. biol. Chem.* 253 (1978) 6086.
- 20 Oates, M.D., Rosbottom, A.C., and Schragar, J., *Carbohydr. Res.* 34 (1974) 115.
- 21 Lloyd, K.O., and Kabat, E.A., *Proc. natl Acad. Sci. USA* 67 (1968) 1470.
- 22 Carlson, D.M., *J. biol. Chem.* 243 (1968) 616.
- 23 Tai, T., Yamashita, K., Ito, S., and Kobata, A., *J. biol. Chem.* 252 (1977) 6687.
- 24 Yamashita, K., Tachibana, Y., and Kobata, A., *J. biol. Chem.* 253 (1979) 3862.
- 25 Yoshima, H., Furthmayr, H., and Kobata, A., *J. biol. Chem.* 255 (1980) 9713.
- 26 Takasaki, S., Yamashita, K., Suzuki, K., and Kobata, A., *J. Biochem., Tokyo* 88 (1980) 1587.
- 27 Takasaki, S., Yamashita, K., Suzuki, K., Iwanaga, S., and Kobata, A., *J. biol. Chem.* 254 (1979) 8548.
- 28 Yoshima, H., Matsumoto, A., Mizuochi, T., Kawasaki, T., and Kobata, A., *J. biol. Chem.* 256 (1981) 8476.
- 29 Huang, C.-C., Mayer, Jr, H.E., and Montgomery, R., *Carbohydr. Res.* 13 (1970) 127.
- 30 Tarentino, A.L., Plummer, T.H., and Maley, F., *J. biol. Chem.* 245 (1970) 4150.
- 31 Liang, C.-J., Yamashita, K., and Kobata, A., *J. Biochem., Tokyo* 88 (1980) 51.
- 32 Endo, Y., Yamashita, K., Tachibana, Y., Tojo, S., and Kobata, A., *J. Biochem., Tokyo* 85 (1979) 669.
- 33 Mizuochi, T., and Kobata, A., *Biochem. biophys. Res. Commun.* 97 (1980) 772.
- 34 Swaminathan, N., and Bahl, O.P., *Biochem. biophys. Res. Commun.* 40 (1970) 422.
- 35 Mizuochi, T., Fujikawa, K., Titani, K., and Kobata, A., in: *Glycoconjugate*, p.267. Eds T. Yamakawa, T. Osawa and S. Handa. Jap. sci. Soc. Press, Tokyo 1981.
- 36 Hakomori, S.-I., *J. Biochem., Tokyo* 55 (1964) 205.
- 37 Lönngrén, J., and Svensson, S., *Adv. Carbohydr. Chem. Biochem.* 29 (1974) 41.
- 38 Radford, T., De Songh, D.C., in: *Biochemical Applications of Mass Spectrometry*, suppl. vol.1, p.255. Eds G.R. Waller and O.C. Dermer. Wiley-Interscience, New York 1980.
- 39 Rauvala, H., Finne, J., Krusius, T., Kärkkäinen, J., and Järnefelt, J., *Adv. Carbohydr. Chem. Biochem.* 38 (1981) 389.
- 40 Lindberg, B., Lönngrén, J., and Svensson, S., *Adv. Carbohydr. Chem. Biochem.* 31 (1975) 185.
- 41 Lindberg, B., and Lönngrén, J., *Meth. Enzymol.* 50 (1978) 3.
- 42 Nilsson, B., Ph. D. thesis, University of Lund, Sweden, 1978.
- 43 Vliegthart, J.F.G., van Halbeek, H., and Dorland, L., *Pure appl. Chem.* 53 (1981) 45.
- 44 Spiro, R.G., *Adv. Protein Chem.* 27 (1973) 349.
- 45 Yamamoto, K., Tsuji, T., Masumoto, I., and Osawa, T., *Biochemistry* 20 (1981) 5894.
- 46 Li, S.-C., Iwase, H., and Li, Y.-T., in: *Proc. 6th Int. Symp. Glycoconjugates, Japan*, p.26. Eds T. Yamakawa, T. Osawa and S. Handa. Jap. sci. Soc. Press, Tokyo 1981.
- 47 Zinn, A.B., Plantner, J.J., and Carlson, D.M., in: *The Glycoconjugates*, vol. I, p.65. Eds M.I. Horowitz and W. Pigman. Academic Press, New York 1977.
- 48 Rasilo, M.-L., and Renkonen, O., *FEBS Lett.* 135 (1981) 38.
- 49 Ogata, S., and Lloyd, K.O., *Analyt. Biochem.* 119 (1982) 351.
- 50 Bayard, B., and Kerckaert, J.-P., *Eur. J. Biochem.* 113 (1981) 405.
- 51 Plummer, T.H., and Tarentino, A.L., *J. biol. Chem.* 256 (1981) 10243.
- 52 Tabas, I., and Kornfeld, S., *J. biol. Chem.* 255 (1980) 6633.
- 53 Donald, A.S.R., Soh, C.P.C., Watkins, W.M., and Morgan, W.T.J., *Biochem. biophys. Res. Commun.* 104 (1982) 58.
- 54 Suttajit, M., and Winzler, R.J., *J. biol. Chem.* 246 (1971) 3398.
- 55 Yamashita, K., Mizuochi, T., and Kobata, A., *Meth. Enzymol.* 83 (1982) 105.
- 56 Bergh, M.L.E., Koppen, P., and van den Eijnden, D.H., *Carbohydr. Res.* 94 (1981) 225.

- 57 Boersma, A., Lamblin, G., Degand, P., and Roussel, P., *Carbohydr. Res.* **94** (1981) C7.
- 58 Baenziger, J.U., and Natowicz, M., *Analyt. Biochem.* **112** (1981) 357.
- 59 Mellis, S.J., and Baenziger, J.U., *Analyt. Biochem.* **114** (1981) 276.
- 60 Ogata, S., Muramatsu, T., and Kobata, A., *J. Biochem., Tokyo* **78** (1975) 687.
- 61 Krusius, T., and Finne, J., *Eur. J. Biochem.* **78** (1977) 369.
- 62 Debray, H., Decout, D., Strecker, G., Spik, G., and Montreuil, J., *Eur. J. Biochem.* **117** (1981) 41.
- 63 Krusius, T., and Finne, J., *Carbohydr. Res.* **90** (1981) 203.
- 64 Fournet, B., Dhalluin, J.-M., Strecker, G., Montreuil, J., Bosso, C., and Defaye, J., *Analyt. Biochem.* **108** (1980) 35.
- 65 Strecker, G., Pierce-Cretel, A., Fournet, B., Spik, G., and Montreuil, J., *Analyt. Biochem.* **111** (1981) 17.
- 66 Sawardeker, J.S., Sloneker, J.H., and Jeanes, A.R., *Analyt. Chem.* **37** (1965) 1602.
- 67 Dutton, G.G.S., *Adv. Carbohydr. Chem. Biochem.* **28** (1973) 11.
- 68 Prehm, P., and Scheid, A., *J. Chromat.* **166** (1978) 461.
- 69 Schauer, R., *Meth. Enzymol.* **50** (1978) 64.
- 70 Kamerling, J.P., Vliegthart, J.F.G., Versluis, C., and Schauer, R., *Carbohydr. Res.* **41** (1975) 7.
- 71 Kamerling, J.P., Haverkamp, J., Vliegthart, J.F.G., Versluis, C., and Schauer, R., *Recent Dev. Mass Spectrom. Biochem. Med.* **1** (1978) 503.
- 72 Kamerling, J.P., and Vliegthart, J.F.G., in: *Sialic Acids-Chemistry, Metabolism and Function*. Ed. R. Schauer. Springer-Verlag, Wien 1982, in press.
- 73 Chambers, R.E., and Clamp, J.R., *Biochem. J.* **125** (1971) 1009.
- 74 Clamp, J.R., Bhatti, T., and Chambers, R.E., *Meth. biochem. Analysis* **19** (1971) 229.
- 75 Kamerling, J.P., Gerwig, G.J., Vliegthart, J.F.G., and Clamp, J.R., *Biochem. J.* **151** (1975) 491.
- 76 Kamerling, J.P., Gerwig, G.J., and Vliegthart, J.F.G., *XIth Int. Carbohydr. Symp., Vancouver, Canada 1982*; abstr., in press.
- 77 Zanetta, J.P., Breckenridge, W.C., and Vincendon, G., *J. Chromat.* **69** (1972) 291.
- 78 Wran, M.M., and Todd, C.W., *J. Chromat.* **147** (1978) 309.
- 79 Pritchard, D.G., and Niedermeier, W., *J. Chromat.* **152** (1978) 487.
- 80 Gerwig, G.J., Kamerling, J.P., and Vliegthart, J.F.G., *Carbohydr. Res.* **62** (1978) 349.
- 81 Gerwig, G.J., Kamerling, J.P., and Vliegthart, J.F.G., *Carbohydr. Res.* **77** (1979) 1.
- 82 Jansson, P.-E., Kenne, L., Liedgren, H., Lindberg, B., and Lönngren, J., *Chem. Commun. Univ. Stockholm*, 1976, No. 8.
- 83 Stellner, K., Saito, H., and Hakomori, S.-I., *Archs Biochem. Biophys.* **155** (1973) 464.
- 84 Fukuda, M., and Hakomori, S.-I., *J. biol. Chem.* **254** (1979) 5451.
- 85 Schwarzmann, G.O.H., and Jeanloz, R.W., *Carbohydr. Res.* **34** (1974) 161.
- 86 Tai, T., Yamashita, K., and Kobata, A., *J. Biochem., Tokyo* **78** (1978) 679.
- 87 Caroff, M., and Szabo, L., *Carbohydr.* **84** (1980) 43.
- 88 Laine, R.A., and Sweeley, C.C., *Carbohydr. Res.* **27** (1973) 199.
- 89 Dmitriev, B.A., Backinowsky, L.V., Chizhov, O.S., Zolotarev, B.M., and Kochetkov, N.K., *Carbohydr. Res.* **19** (1971) 432.
- 90 Seymour, F.R., Plattner, R.D., and Slodki, *Carbohydr. Res.* **44** (1975) 181.
- 91 Li, B.W., Cochran, T.W., and Vercellotti, *Carbohydr. Res.* **59** (1977) 567.
- 92 McNeil, M., and Albersheim, P., *Carbohydr. Res.* **56** (1977) 239.
- 93 van Halbeek, H., Haverkamp, J., Kamerling, J.P., Vliegthart, J.F.G., Versluis, C., and Schauer, R., *Carbohydr. Res.* **60** (1978) 51.
- 94 Bruvier, C., Leroy, Y., Montreuil, J., Fournet, B., and Kamerling, J.P., *J. Chromat.* **210** (1981) 487.
- 95 Matsubara, T., and Hayashi, A., *Biomed. Mass Spectrom.* **1** (1974) 62.
- 96 Fournet, B., Strecker, G., Leroy, Y., and Montreuil, J., *Analyt. Biochem.* **116** (1981) 489.
- 97 Kochetkov, N.K., and Chizhov, O.S., *Adv. Carbohydr. Chem.* **21** (1966) 39.
- 98 Hanessian, S., *Meth. biochem. Analysis* **19** (1971) 205.
- 99 Radford, T., and DeJongh, D.C., in: *Biochemical Applications of Mass Spectrometry*, p.313. Ed. G. Waller. Wiley-Interscience, New York, 1972.
- 100 Kärkkäinen, J., *Carbohydr. Res.* **14** (1970) 27.
- 101 Kärkkäinen, J., *Carbohydr. Res.* **17** (1971) 11.
- 102 Chizhov, O.S., Kadentsev, V.I., Solov'yov, A.A., Levonovich, P.F., and Dougherty, R.C., *J. org. Chem.* **41** (1976) 3425.
- 103 Mononen, I., Finne, J., and Kärkkäinen, J., *Carbohydr. Res.* **60** (1978) 371.
- 104 de Jong, E.G., Heerma, W., Haverkamp, J., and Kamerling, J.P., *Biomed. Mass Spectrom.* **6** (1979) 72.
- 105 de Jong, E.G., Heerma, W., and Sicherer, C.A.X.G.F., *Biomed. Mass Spectrom.* **6** (1979) 242.
- 106 Jensen, M., Borowiak, D., Paulsen, H., and Rietschel, E.Th., *Biomed. Mass Spectrom.* **6** (1979) 559.
- 107 de Jong, E.G., Heerma, W., and Dijkstra, G., *Biomed. Mass Spectrom.* **7** (1980) 127.
- 108 Kováčik, V., Bauer, Š., Rosik, J., and Kovác, P., *Carbohydr. Res.* **8** (1968) 282.
- 109 Karlsson, K.-A., Pascher, I., Samuelsson, B.E., Finne, J., Krusius, T., and Rauvala, H., *FEBS Lett.* **94** (1978) 413.
- 110 Hallgren, P., and Lundblad, A., *J. biol. Chem.* **252** (1977) 1014.
- 111 Hallgren, P., and Lundblad, A., *J. biol. Chem.* **252** (1977) 1023.
- 112 Lundblad, A., Lundsten, J., Nordén, N., Sjöblad, S., Svensson, S., Oeckerman, P.-A., and Gehlhoff, M., *Eur. J. Biochem.* **83** (1978) 513.
- 113 Takasaki, S., Yamashita, K., and Kobata, A., *J. biol. Chem.* **253** (1978) 6086.
- 114 Maury, P., and Kärkkäinen, J., *Clinica chim. Acta* **91** (1979) 75.
- 115 Chester, M.A., Hallgren, P., Lundblad, A., and Messeter, L., *Eur. J. Biochem.* **100** (1979) 385.
- 116 Fukuda, M.N., Papermaster, D.S., and Hargrave, P.A., *J. biol. Chem.* **254** (1979) 8201.
- 117 Derappe, C., Lundblad, A., Messeter, L., and Svensson, S., *FEBS Lett.* **119** (1980) 177.
- 118 Inoue, S., Iwasaki, M., and Matsumura, *Biochem. biophys. Res. Commun.* **102** (1981) 1295.
- 119 Matsuura, F., Laine, R.A., and Jones, M.Z., *Archs Biochem. Biophys.* **211** (1981) 485.
- 120 Kuriyama, M., Ariga, T., Ando, S., Suzuki, M., Yamada, T., and Miyatake, T., *J. biol. Chem.* **256** (1981) 12316.
- 121 van Halbeek, H., Dorland, L., Haverkamp, J., Veldink, G.A., Vliegthart, J.F.G., Fournet, B., Ricart, G., Montreuil, J., Gathmann, W.D., and Aminoff, D., *Eur. J. Biochem.* **118** (1981) 487.
- 122 Saito, T., Itoh, T., Adachi, S., Suzuki, T., and Usui, T., *Biochim. biophys. Acta* **678** (1981) 257.
- 123 Hounsell, E.F., Wood, E., Feizi, T., Fukuda, M., Powell, M.E., and Hakomori, S.-I., *Carbohydr. Res.* **90** (1981) 283.
- 124 Pierce-Cretel, A., Pamblanco, M., Strecker, G., Montreuil, J., and Spik, G., *Eur. J. Biochem.* **114** (1981) 169.
- 125 Egge, H., Michalski, J.-C., and Strecker, G., *Archs Biochem. Biophys.* **213** (1982) 318.
- 126 Lindscheid, M., D'Angona, J., Burlingame, A.L., Dell, A., and Ballou, C.E., *Proc. natl Acad. Sci. USA* **78** (1981) 1471.
- 127 Jardetzky, O., and Roberts, G.C.K., *NMR in Molecular Biology*. Academic Press, New York 1981.
- 128 Dorland, L., Haverkamp, J., Schut, B.L., Vliegthart, J.F.G., Spik, G., Strecker, G., Fournet, B., and Montreuil, J., *FEBS Lett.* **77** (1977) 15.
- 129 Vliegthart, J.F.G., van Halbeek, H., and Dorland, L., in: *IUPAC 27th Int. Congr. Pure Appl. Chem. Helsinki 1979*, p.253. Ed. A. Varmavuori. Pergamon, Oxford, 1980.
- 130 Vliegthart, J.F.G., Dorland, L., and van Halbeek, H., *Adv. Carbohydr. Chem. Biochem.* (1982) in press.
- 131 van Halbeek, H., Thesis, State University of Utrecht, Utrecht 1982, The Netherlands.
- 132 van Halbeek, H., Dorland, L., Vliegthart, J.F.G., Jouanneau, J., and Bourillon, R., *Biochem. Biophys. Res. Commun.* **99** (1981) 886.
- 133 van Halbeek, H., Dorland, L., Vliegthart, J.F.G., Mon-



- treuil, J., Fournet, B., and Schmid, K., *J. biol. Chem.* 256 (1981) 5588.
- 134 van den Eijnden, D.H., Joziassse, D.H., Dorland, L., van Halbeek, H., Vliegthart, J.F.G., and Schmid, K., *Biochem. biophys. Res. Commun.* 92 (1980) 839.
- 135 Schachter, H., and Roseman, S., in: *The Biochemistry of Glycoproteins and Proteoglycans*, p.85. Ed. W.J. Lennarz. Plenum Press, New York 1980.
- 136 Beyer, T.A., Sadler, J.E., Rearick, J.I., Paulson, J.C., and Hill, R.L., *Adv. Enzymol.* 52 (1981) 23.
- 137 Hubbard, S.C., and Ivatt, R.J., *A. Rev. Biochem.* 50 (1981) 555.
- 138 Sharon, N., and Lis, H., 1982, in: *The Proteins*, vol.5. Eds H. Neurath and R.L. Hill. Academic Press, New York 1982, in press.
- 139 Bartholomew, B.A., Jourdian, G.W., and Roseman, S., *J. biol. Chem.* 248 (1973) 5751.
- 140 Paulson, J.C., Rearick, J.I., and Hill, R.L., *J. biol. Chem.* 252 (1977) 2363.
- 141 Hagopian, A., and Eylar, E.H., *Archs Biochem. Biophys.* 128 (1968) 422.
- 142 Schachter, H., and Rodén, L., in: *Metabolic Conjugation, Metabolic Hydrolysis*, p.1. Ed. W.H. Fishman. Academic Press, New York 1973.
- 143 Palade, G., *Science* 189 (1975) 347.
- 144 Rothman, J.E., and Fine, R.E., *Proc. natl Acad. Sci. USA* 77 (1980) 780.
- 145 Rothman, J., *Science* 213 (1981) 1212.
- 146 Roth, J., and Berger, E.G., *J. Cell Biol.* 93 (1982) 223.
- 147 Neufeld, E.F., and Ashwell, G., in: *The Biochemistry of Glycoproteins and Proteoglycans*, p.241. Ed. W.J. Lennarz. Plenum Press, New York 1980.
- 148 Tartakoff, A.M., *Int. Rev. exp. Path.* 22 (1980) 227.
- 149 Hasilik, A., *Trends biochem. Sci.* 5 (1980) 237.
- 150 Hanover, J.A., Lennarz, W.J., and Young, J.D., *J. biol. Chem.* 255 (1980) 6713.
- 151 Hill, H.D., Schwyzer, M., Steinman, H.M., and Hill, R.L., *J. biol. Chem.* 252 (1977) 3799.
- 152 Strous, G.J.A.M., *Proc. natl Acad. Sci. USA* 76 (1979) 2694.
- 153 Kim, Y.S., Perdomo, J., and Nordberg, J., *J. biol. Chem.* 246 (1971) 5466.
- 154 Ko, G.K.W., and Raghupathy, E., *Biochim. biophys. Acta* 264 (1972) 129.
- 155 Schachter, H., McGuire, E.J., and Roseman, S., *J. biol. Chem.* 246 (1971) 5321.
- 156 Beyer, T.A., Rearick, J.I., Paulson, J.C., Prieels, J.-P., Sadler, J.I., and Hill, R.L., *J. biol. Chem.* 254 (1979) 12531.
- 157 Kornfeld, R., and Kornfeld, S., *A. Rev. Biochem.* 45 (1976) 217.
- 158 Watkins, W.M., in: *Proc. 7th Congr. Int. Soc. Blood Transfusion*, p.692. Ed. L. Holländer. Karger, Basel 1959.
- 159 Race, C., Zideman, D., and Watkins, W.M., *Biochem. J.* 107 (1968) 733.
- 160 Kobata, A., Grollman, E.F., and Ginsburg, V., *Biochem. Biophys. Res. Commun.* 32 (1968) 272.
- 161 Hearn, V.M., Smitz, Z.G., and Watkins, W.M., *Biochem. J.* 109 (1960) 315.
- 162 Kobata, A., Grollman, E.F., and Ginsburg, V., *Archs Biochem. Biophys.* 124 (1968) 609.
- 163 Tuppy, H., and Staudenbauer, W.L., *Nature* 210 (1966) 316.
- 164 Parodi, A.J., Behrens, N.H., Leloir, L.F., and Carminatti, H., *Proc. natl Acad. Sci. USA* 69 (1972) 3268.
- 165 Waechter, C.J., and Lennarz, W.J., *A. Rev. Biochem.* 45 (1976) 95.
- 166 Staneloni, R.J., and Leloir, L.F., *Trends biochem. Sci.* 4 (1979) 65.
- 167 Gibson, G., Kornfeld, S., and Schlesinger, S., *Trends biochem. Sci.* 5 (1980) 290.
- 168 Struck, D.K., and Lennarz, W.J., in: *The Biochemistry of Glycoproteins and Proteoglycans*, p.35. Ed. W.J. Lennarz. Plenum Press, New York 1980.
- 169 Elbein, A.D., *A. Rev. Pl. Physiol.* 30 (1979) 239.
- 170 Parodi, A.J., and Leloir, L.F., *Biochim. biophys. Acta* 599 (1979) 1.
- 171 Li, E., Tabas, I., and Kornfeld, S., *J. biol. Chem.* 253 (1978) 7762.
- 172 Sharon, N., and Lis, H., *Chem. Engng News* 59 (1981) 21.
- 173 Czichi, V., and Lennarz, W.J., *J. biol. Chem.* 252 (1977) 7901.
- 174 Nilsson, O.S., DeTomas, M.E., Peterson, E., Bergman, A., Dallner, G., and Hemming, F.W., *Eur. J. Biochem.* 89 (1978) 619.
- 175 Snider, M.D., Sultzman, L.A., and Robbins, P.W., *Cell* 21 (1980) 385.
- 176 Hanover, J.A., and Lennarz, W.J., *J. biol. Chem.* 254 (1978) 9237.
- 177 Takatsuki, A., Kohno, K., and Tamura, G., *Agric. Biol. Chem.* 39 (1975) 2089.
- 178 Tkacz, J., and Lampen, J.O., *Biochem. biophys. Res. Commun.* 65 (1975) 248.
- 179 Chapman, A., Li, E., and Kornfeld, S., *J. biol. Chem.* 254 (1979) 10243.
- 180 Chambers, J., Forsee, W.T., and Elbein, A.D., *J. biol. Chem.* 252 (1977) 2498.
- 181 Forsee, W.T., Griffin, J.A., and Schutzbach, J.S., *Biochem. biophys. Res. Commun.* 75 (1977) 799.
- 182 Chapman, A., Fujimoto, K., and Kornfeld, S., *J. biol. Chem.* 255 (1980) 4441.
- 183 Rearick, J.I., Fujimoto, K., and Kornfeld, S., *J. biol. Chem.* 256 (1981) 3762.
- 184 Hubbard, S.C., and Robbins, P.W., *J. biol. Chem.* 255 (1980) 11782.
- 185 Chapman, A., Trowbridge, I.S., Hyman, R., and Kornfeld, S., *Cell* 17 (1979) 509.
- 186 Pless, D.D., and Lennarz, W.J., *Proc. natl Acad. Sci. USA* 74 (1977) 134.
- 187 Aubert, J.-P., Biserte, G., and Loucheux-Lefébure, M.-H., *Archs Biochem. Biophys.* 175 (1976) 410.
- 188 Kuntz, I., *J. Am. chem. Soc.* 94 (1972) 4009.
- 189 Bergman, L.W., and Kuehl, W.M., *Biochemistry* 17 (1978) 5174.
- 190 Chen, W.W., and Lennarz, W.J., *J. biol. Chem.* 252 (1977) 3473.
- 191 Lehle, L., and Tanner, W., *Eur. J. Biochem.* 83 (1978) 563.
- 192 Turco, S.J., Stetson, B., and Robbins, P.W., *Proc. natl Acad. Sci. USA* 74 (1977) 4411.
- 193 Turco, S.J., and Robbins, P.W., *J. biol. Chem.* 254 (1979) 4560.
- 194 Spiro, M.J., Spiro, R.G., and Bhojroo, V.D., *J. biol. Chem.* 254 (1979) 7668.
- 195 Rearick, J.I., Chapman, A., and Kornfeld, S., *J. biol. Chem.* 256 (1981) 6255.
- 196 Robbins, P.W., Hubbard, S.C., Turco, S.J., and Wirth, D.F., *Cell* 12 (1977) 893.
- 197 Tabas, I., Schlesinger, S., and Kornfeld, S., *J. biol. Chem.* 253 (1978) 716.
- 197a Hunt, L.T., Etchison, J.R., and Summers, D.F., *Proc. natl Acad. Sci. USA* 75 (1978) 754.
- 198 Ito, S., Yamashita, K., Spiro, R.G., and Kobata, A., *J. Biochem. Tokyo* 87 (1979) 1621.
- 199 Chapman, A., and Kornfeld, R., *J. biol. Chem.* 254 (1979) 824.
- 200 Compans, R.W., Nakamura, K., Roth, M., Holloway, W.L., and Kemp, M.C., in: *Structure and Variation in Influenza Virus*, p.223. Eds G. Lauer and G. Air. Elsevier/North Holland, New York 1980.
- 201 Schwartz, R.T., and Klenk, H.-D., *Virology* 113 (1981) 584.
- 202 Rothman, J.E., Bursztyn-Pettegrew, H., and Fine, R.E., *J. Cell Biol.* 86 (1980) 162.
- 203 Grinna, L.S., and Robbins, P.W., *J. biol. Chem.* 254 (1979) 8814.
- 204 Opheim, D.J., and Touster, O., *J. biol. Chem.* 253 (1978) 1017.
- 205 Tabas, I., and Kornfeld, S., *J. biol. Chem.* 254 (1979) 11655.
- 206 Tabas, I., and Kornfeld, S., *J. biol. Chem.* 253 (1978) 7779.
- 207 Harpaz, N., and Schachter, H., *J. biol. Chem.* 255 (1980) 4894.
- 208 Liang, C.-J., Yamashita, K., Muellenberg, C.G., Shichi, H., and Kobata, A., *J. biol. Chem.* 254 (1979) 6414.
- 209 Schmid, K., Nimberg, R.B., Kimura, A., Yamaguchi, H., and Binette, J.P., *Biochim. biophys. Acta* 492 (1977) 291.
- 210 Fournet, B., Montreuil, J., Strecker, G., Dorland, L., Haverkamp, J., Vliegthart, J.F.G., Binette, J.P., and Schmid, K., *Biochemistry* 17 (1978) 5206.
- 211 Jabbal, I., and Schachter, H., *J. biol. Chem.* 246 (1971) 5154.
- 212 Wilson, J.R., Williams, D., and Schachter, H., *Biochem. biophys. Res. Commun.* 72 (1976) 909.
- 213 Paulson, J.C., Prieels, J.-P., Glasgow, L.R., and Hill, R.L., *J. biol. Chem.* 254 (1978) 12531.

- 214 Ivatt, R., Proc. natl Acad. Sci. USA 78 (1981) 4021.
- 215 Roth, M.J., Fitzpatrick, J.P., and Compans, R.W., Proc. natl Acad. Sci. USA 76 (1979) 6430.
- 216 Alanso, F.V., and Compans, R.W., J. Cell Biol. 91 (1981) 392a.
- 217 Strous, G.J.A.M., and Lodish, H.F., Cell 22 (1980) 709.
- 218 Hickman, S., Shapiro, L.J., and Neufeld, E.F., Biochem. biophys. Res. Commun. 57 (1974) 55.
- 219 Kaplan, A., Achord, D.T., and Sly, W.S., Proc. natl Acad. Sci. USA 74 (1977) 2026.
- 220 Natowicz, M.R., Chi, M.M.Y., Lowry, O.H., and Sly, W.S., Proc. natl Acad. Sci. USA 76 (1979) 4322.
- 221 von Figura, K., and Klein, V., Eur. J. Biochem. 94 (1979) 347.
- 222 Distler, J., Hieber, U., Sahagian, G., Schmickel, R., and Jourdian, G.W., Proc. natl Acad. Sci. USA 76 (1979) 4235.
- 223 Hasilik, A., and Neufeld, E.F., J. biol. Chem. 255 (1980) 4946.
- 224 Bach, G., Bargal, R., and Cantz, M., Biochem. biophys. Res. Commun. 91 (1979) 976.
- 225 Hasilik, A., Waheed, A., and von Figura, K., Biochem. biophys. Res. Commun. 98 (1981) 761.
- 226 Hasilik, A., Klein, V., Waheed, A., Strecker, G., and von Figura, K., Proc. natl Acad. Sci. USA 77 (1980) 7074.
- 227 Waheed, A., Pohlmann, R., Hasilik, A., and von Figura, K., J. biol. Chem. 256 (1981) 4150.
- 228 Varki, A., and Kornfeld, S., J. biol. Chem. 255 (1980) 8398.
- 229 Reitman, M.L., and Kornfeld, S., J. biol. Chem. 256 (1981) 11977.
- 230 Goldberg, D.E., and Kornfeld, S., J. biol. Chem. 256 (1981) 13060.
- 231 Rome, L.H., Garvin, A.J., Alietta, M.M., and Neufeld, E.F., Cell 17 (1979) 143.
- 232 Kornfeld, S., Li, E., and Tabas, I., J. biol. Chem. 253 (1978) 7771.
- 233 Reitman, M.L., Varki, A., and Kornfeld, S., J. clin. Invest. 67 (1981) 1574.
- 234 Sharon, N., and Lis, H., in: The Proteins, vol. V. 3rd edn. Eds H. Neurath, and R.L. Hill. Academic Press, New York 1980.
- 235 Morell, A.G., Irvine, R.A., Sternlieb, I., Scheinberg, I.H., and Ashwell, G., J. biol. Chem. 243 (1968) 155.
- 236 Kawasaki, T., and Ashwell, G., J. biol. Chem. 251 (1976) 1296.
- 237 Schwartz, A.L., Marshalk-Rothstein, A., Rup. D., and Lodish, H.F., Proc. natl Acad. Sci. USA 78 (1981) 3348.
- 238 Stockert, R.J., Howard, D.J., Morell, A.G., and Scheinberg, I.H., J. biol. Chem. 255 (1980) 9028.
- 239 Novogrodsky, A., and Ashwell, G., Proc. natl Acad. Sci. USA 74 (1977) 676.
- 240 Sarkar, M., Liao, J., Kabat, E.A., Tanabe, T., and Ashwell, G., J. biol. Chem. 254 (1979) 3170.
- 241 Steer, C.J., and Ashwell, G., J. biol. Chem. 255 (1980) 3008.
- 242 Tanabe, T., Pricer, Jr, W.E., and Ashwell, G., J. biol. Chem. 254 (1979) 1038.
- 243 Prieels, J.-P., Pizzo, S.V., Glasgow, L.R., Paulson, J.C., and Hill, R.L., Proc. natl Acad. Sci. USA 75 (1978) 2215.
- 244 Lunney, J., and Ashwell, G., Proc. natl Acad. Sci. USA 73 (1976) 342.
- 245 Neufeld, E.F., Lim, T.W., and Shapiro, L.J., A. Rev. Biochem. 44 (1975) 357.
- 246 Rome, L.H., Weissmann, B., and Neufeld, E.F., Proc. natl Acad. Sci. USA 76 (1979) 2331.
- 247 Fischer, H.D., Gonzalez-Noriega, A., and Sly, W.S., J. biol. Chem. 255 (1980) 5069.
- 248 Kaplan, A., Fischer, D., Achord, D.T., and Sly, W.S., J. clin. Invest. 60 (1977) 1088.
- 249 Sando, G.N., and Neufeld, E.F., Cell 12 (1977) 619.
- 250 Ullrich, L., Mersmann, G., Weber, E., and von Figura, K., Biochem. J. 170 (1978) 643.
- 251 Hickman, S., and Neufeld, E.F., Biochem. biophys. Res. Commun. 49 (1972) 992.
- 252 Sahagian, G.G., Distler, J., and Jourdian, G.W., Proc. natl Acad. Sci. USA 78 (1981) 4289.
- 253 Hasilik, A., and Neufeld, E.F., J. biol. Chem. 255 (1980) 4946.
- 254 Hasilik, A., Rome, L.N., and Neufeld, E.F., Fedn Proc. 38 (1979) 467.
- 255 Stahl, P., Schlesinger, P., Rodman, J.S., and Doebber, T., Nature, Lond. 264 (1976) 86.
- 256 Stahl, P., Rodman, J.S., Miller, M.J., and Schlesinger, P.H., Proc. natl Acad. Sci. USA 75 (1978) 1399.
- 257 Stahl, P., Sigardson, E.O., Rodman, J.S., Schlesinger, P.H., and Lee, Y.C., Cell 19 (1980) 207.
- 258 Stahl, P., and Schlesinger, P.H., Trends biochem. Sci. 5 (1980) 194.
- 259 Day, J.F., Thornburg, R.W., Thorpe, S.R., and Baynes, J.W., J. biol. Chem. 255 (1980) 2360.
- 260 Warr, G.A., Biochem. biophys. Res. Commun. 93 (1980) 737.
- 261 Crandall, M., and Brock, T., Bact. Rev. 32 (1968) 139.
- 262 Bolwell, G.P., Callow, J.A., Callow, M.E., and Evans, L.V., J. Cell Sci. 36 (1979) 19.
- 263 Barondes, S.H., and Rosen, S.D., in: Neuronal Recognition, p. 331. Ed. S.H. Barondes. Plenum Press, New York 1976.
- 264 Burrigide, K., and Jordan, L., Exp. Cell Res. 124 (1979) 31.
- 265 Jancik, J., and Schauer, R., Hoppe-Seyler's Z. physiol. Chem. 355 (1974) 395.
- 266 Skutelsky, E., Lotan, R., Sharon, N., and Danon, D., Biochim. biophys. Acta 467 (1977) 165.
- 267 Lutz, H.U., and Fehr, J., J. biol. Chem. 254 (1979) 11177.
- 268 Kay, M.M.B., J. supramolec. Struct. 9 (1978) 555.
- 269 Woodruff, J.J., and Woodruff, J.F., J. Immun. 117 (1976) 852.
- 270 Gottschalk, A., The chemistry and biology of sialic acids and related substances. Cambridge Univ. Press, London 1960.
- 271 Bar-Shavit, Z., Ofek, I., Goldman, R., Mirelman, D., and Sharon, N., Biochem. biophys. Res. Commun. 78 (1977) 455.
- 272 Eshdat, Y., Ofek, I., Yashouv-Gan, Y., Sharon, N., and Mirelman, D., Biochem. biophys. Res. Commun. 85 (1978) 1551.
- 273 Sharon, N., Scient. Am. 243 (1980) 90.
- 274 Vaheri, A., Ruoslahti, E., and Mosher, D.F., Fibroblast surface protein. Ann. N.Y. Acad. Sci. 312 (1978) 1.
- 275 Grinell, F., Experientia 36 (1980) 505.
- 276 Vischer, P., and Hughes, R.C., Eur. J. Biochem. 117 (1981) 275.
- 277 Hughes, R.C., and Pena, S.D.J., Nature 276 (1978) 80.
- 278 Mescher, M.F., Trends biochem. Sci. 6 (1981) 97.
- 279 Mescher, M.F., and Strominger, J.L., J. biol. Chem. 251 (1976) 2005.
- 280 Mescher, M.F., and Strominger, J.L., J. gen. Microbiol. 89 (1975) 375.
- 281 Bretscher, M.S., Science 181 (1973) 622.
- 282 Schwarz, R.T., and Datema, R., Trends Biochem. Sci. 5 (1980) 65.
- 283 Elbein, A.D., Trends biochem. Sci. 6 (1980) 219.
- 284 Gibson, R., Kornfeld, S., and Schlesinger, S., J. biol. Chem. 256 (1981) 456.
- 284a Meyer, F.A., Krieg, M., and Gelman, R.A., Biochim. biophys. Acta 392 (1975) 223.
- 285 Feeny, R.E., and Yeh, Y., Adv. Prot. Chem. 32 (1978) 191.
- 286 Ananthanarayanan, V.S., and New, C.L., Nature 268 (1977b) 560.
- 287 Rodén, L., in: The biochemistry of glycoproteins and proteoglycans, p.267. Ed. W.J. Lennarz. Plenum Press, New York and London 1980.
- 288 Caterson, B., and Baker, J.R., J. biol. Chem. 254 (1978) 2394.
- 289 Sheehan, J.K., Nieduszynski, I.A., Phelps, C.F., Muir, H., and Hardingham, T.E., Biochem. J. 171 (1978) 109.
- 290 Lindahl, U., Bäckström, G., Thunberg, L., and Leder, I.G., Proc. natl Acad. Sci. USA 76 (1980) 1218.
- 291 Lindahl, U., and Höök, M., A. Rev. Biochem. 47 (1978) 385.
- 292 von Figura, K., and Weber, E., Biochem. J. 176 (1978) 943.
- 293 Sly, S.L., Natowicz, M., Gonzales-Noriega, A., Grubb, H., and Fischer, H.D., in: Lysosomes and lysosomal storage diseases. Eds I.W. Callahan and I.A. Lowden. Raven Press, New York 1981.
- 294 Lis, H., and Sharon, N., in: The Biochemistry of plants, vol. 6, p.371. Ed. A. Marcus. Academic Press, New York 1981.
- 295 Parsons, T.F., and Pierce, J.G., Proc. natl Acad. Sci. USA 77 (1980) 7089.
- 296 Hortin, G., Natowicz, M., Pierce, J., Baenziger, J., Parsons, T., and Boime, I., Proc. natl Acad. Sci. USA 78 (1981) 7468.
- 297 Strous, G.J.A.M., and Berger, E.G., J. biol. Chem. 257 (1982) 7623.
- 298 Stanley, P., in: The Biochemistry of Glycoproteins and Proteoglycans, p.161. Ed. W. Lennarz. Plenum Press, New York 1980.