

# Study of Surface Acoustic Wave Streaming Phenomenon Based on Temperature Measurement and Observation of Streaming in Liquids

Shihoko ITO<sup>1</sup>, Mitsunori SUGIMOTO<sup>2</sup>, Yoshikazu MATSUI<sup>3</sup>, and Jun KONDOH<sup>1,3,4\*</sup>

<sup>1</sup>Graduate School of Science and Engineering, Shizuoka University, Hamamatsu 432-8561, Japan

<sup>2</sup>Research Institute of Electronics, Shizuoka University, Hamamatsu 432-8561, Japan

<sup>3</sup>Department of Systems Engineering, Faculty of Engineering, Shizuoka University, Hamamatsu 432-8561, Japan

<sup>4</sup>Graduate School of Science and Technology, Hamamatsu 432-8561, Japan

(Received November 24, 2006; accepted March 19, 2007; published online July 26, 2007)

A longitudinal wave is radiated into a liquid when the liquid is placed on a surface acoustic wave (SAW) propagating surface. The radiated longitudinal wave induces liquid dynamics, such as vibrating and streaming. This phenomenon is called SAW streaming. The liquid's temperature increases, as the radiated longitudinal wave becomes attenuated inside the liquid. In this paper, the measurement and observation results of temperature and streaming in liquids are described. First, the sol–gel formation of agar–agar is observed. Second, a highly viscous liquid droplet is placed on the SAW propagation surface. However, the stable measurements are difficult. Therefore, a U-type cell is developed and the pattern of the streaming in this cell is observed. The results show that there is an association between the attenuation of a longitudinal wave and the temperature distribution. [DOI: 10.1143/JJAP.46.4718]

KEYWORDS: surface acoustic wave (SAW), SAW streaming, longitudinal wave, viscosity, temperature distribution, vortex

## 1. Introduction

A surface acoustic wave (SAW) device is widely used for mobile communication system.<sup>1)</sup> A SAW, also called a Rayleigh SAW, has an elliptical displacement on a surface. When a liquid is loaded on a SAW propagating surface, the Rayleigh SAW changes to a leaky SAW as a result of a longitudinal wave being radiated into the liquid.<sup>2)</sup> Liquid dynamics, such as vibration, streaming, and small droplet formation, are induced by a longitudinal wave.<sup>3–5)</sup> The dynamics, which is called SAW streaming, depends on the amplitude of SAW.<sup>6)</sup> Recently, a liquid droplet temperature control method was proposed.<sup>7)</sup>

One of our research goal is to develop a liquid-droplet mixing system using a SAW device for micro total analysis system ( $\mu$ -TAS) application. For this purpose, it is necessary to clarify the behavior of a radiated longitudinal wave and the temperature distribution in a liquid droplet. It is well known that a longitudinal wave attenuates in a highly viscous solution and increases liquid temperature. In this paper, the relationships between the attenuation of a longitudinal wave, temperature, and viscosity are studied. First, the sol–gel formation of agar–agar is observed. Second, a highly viscous liquid droplet is considered. The vortex and temperature distribution in the droplet are observed. In order to carry out the simultaneous measurements of temperature and streaming pattern, a U-type liquid cell is fabricated. The results indicate that the liquid temperature distribution is closely associated with the attenuation of a longitudinal wave. On the basis of the experimental results, the association between temperature distribution and the attenuation of a longitudinal wave is discussed.

## 2. Experimental

A 128° rotated *Y*-cut *X*-propagating LiNbO<sub>3</sub> single crystal (Yamaju Ceramics, Aichi, Japan) was used as the SAW substrate in this study. An interdigital transducer (IDT) with

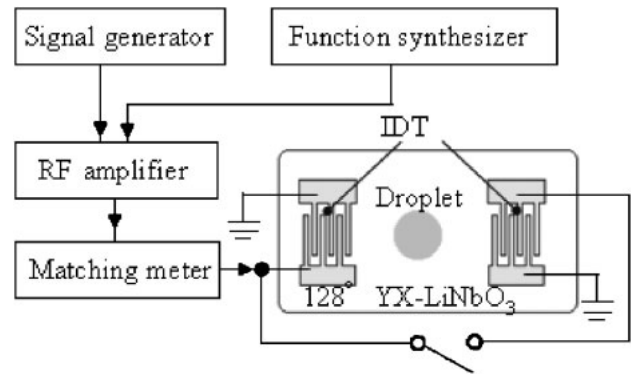

Fig. 1. Schematic diagram of experiment system in this study.

a center frequency of 48.3 MHz was designed and fabricated on the substrate. Figure 1 shows the experimental system. A 48.3 MHz signal from a standard signal generator (Leader 3220) and a pulse signal from a multifunction synthesizer (NF Electronic Instruments 1940) were mixed. Then the signal was amplified by an RF power amplifier (R&K A1000-510) and the amplified signal was fed to the IDT via a matching meter. For the measurements, SAW was excited from one or both IDTs. Duty ratio was fixed at 50%. The amplitude of the applied signal was measured with an oscilloscope (Agilent 54615B). For temperature measurement, a thermocouple thermometer (Fluke 51 K/J) was used. The diameter of the thermometer was 0.1 mm.

## 3. Results and Discussion

### 3.1 Measurement of agar–agar

An agar–agar solution changes from gel to sol with increasing temperature. The change from sol to gel of agar–agar was observed using a SAW device. The agar–agar solution of 30 g/l was heated and a red chalk powder was mixed with it for the visualization of streaming. A 10  $\mu$ l droplet of agar–agar solution (sol) was placed on a SAW propagating surface, and a SAW was generated from the left side of the droplet. The dynamics was observed using a

\*E-mail address: j-kondoh@sys.eng.shizuoka.ac.jp

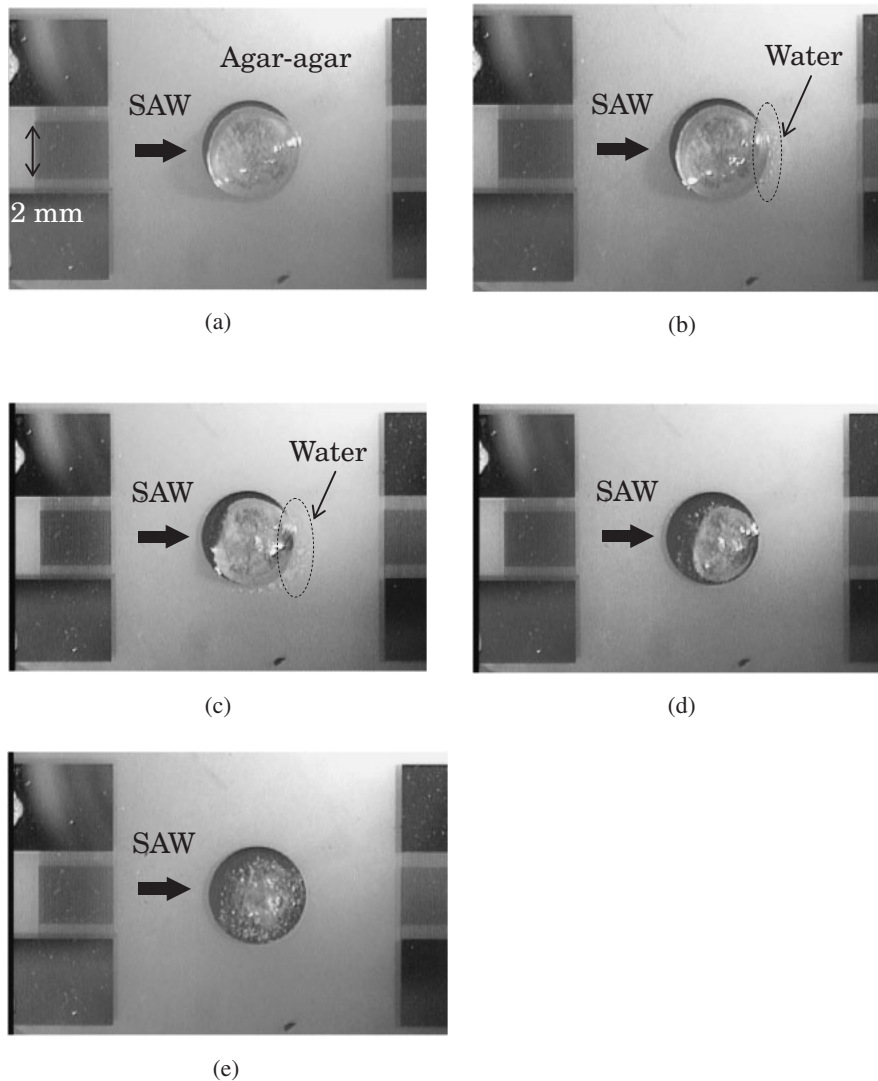

Fig. 2. Observed results of agar-agar. The photograph is taken 60 s after SAW is excited from left IDT. Applied voltages: (a) 10, (b) 15, (c) 20, (d) 25, and (e) 30  $V_{P-P}$ .

charge coupled device (CCD) camera (magnification,  $\times 20$ ). The results obtained 1 min. after the voltage was applied are shown in Fig. 2. When the applied voltage was 10  $V_{P-P}$ , there was no change in the droplet (gel). From 15 to 20  $V_{P-P}$ , water leaked out from the right side [see Fig. 2(b)]. On increasing the applied voltage, the shape of the droplet changed. However, only water was transported by the radiated longitudinal wave, and the powder remained in agar-agar droplet. When the applied voltage was over 25  $V_{P-P}$ , the droplet's volume rapidly decreased. Finally, agar-agar dried as the water got separated and was transported away. From the measurement, the temperature distribution was observed; it is higher on the left side than on the right side. A stable temperature measurement was difficult due to the changing shape of the agar-agar droplet. Therefore, it was not possible to obtain the association between the attenuation of a radiated longitudinal wave and temperature distribution using agar-agar.

### 3.2 Measurement of highly viscous liquid droplet

A liquid droplet was placed on the Rayleigh-SAW propagating surface to observe and measure streaming pattern and temperature change. If the viscosity of a liquid

is low, the droplet is moved by the SAW streaming. In order to avoid it, a 5  $\mu\text{l}$  droplet of a glycerol/water mixture of 80% by weight was used. Ultramarine blue powdered mineral paint (PO642, Holbein Works, Japan) was mixed for the visualization of the streaming pattern. The streaming in the liquid droplet was observed using a CCD camera (magnification,  $\times 50$ ). The SAW was generated from the IDT of one side or both. The aperture of the IDT was 1 mm. Applied voltage and pulse frequency were fixed at 20  $V_{P-P}$  and 1 kHz, respectively. Figures 3–5 show the observed results.

When the center of the droplet was placed on the center line of the SAW propagation, the symmetric two-vortex was observed (see Fig. 3). And when the center of droplet was not on it, the vortex sizes became asymmetric (see Fig 4). Figure 5 shows the results, when the SAWs were excited from the left and right IDTs. The droplet was placed at the center of the SAW propagating surface. As the two vortices were symmetrically produced by a SAW, four vortexes were observed in a bilateral symmetric position.

Droplet temperature measurement was carried out with the SAW generated from the left IDT. Measurement points are shown in Fig. 3(a). The temperature was measured at 1 s interval for 90 s at an initial temperature of 26.0  $^{\circ}\text{C}$  (room

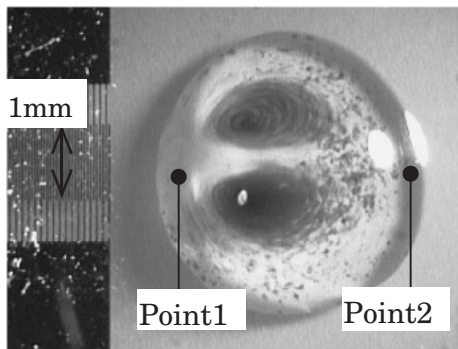

(a)

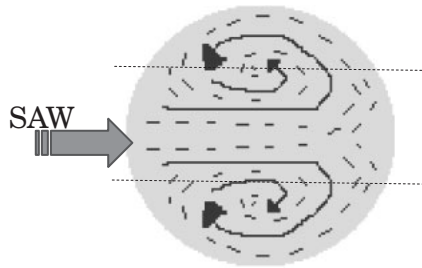

(b)

Fig. 3. Observation results of liquid streaming in 80 wt % glycerol/water droplet, which is placed at center of SAW propagation path. SAW is excited from left IDT. (a) Photograph and (b) illustration.

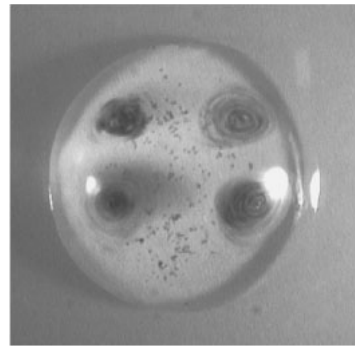

(a)

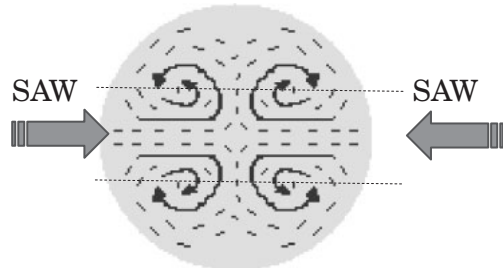

(b)

Fig. 5. Observation results of liquid streaming in 80 wt % glycerol/water droplet, which is placed at center of SAW propagating path. SAW is excited from left and right IDTs. (a) Photograph and (b) illustration.

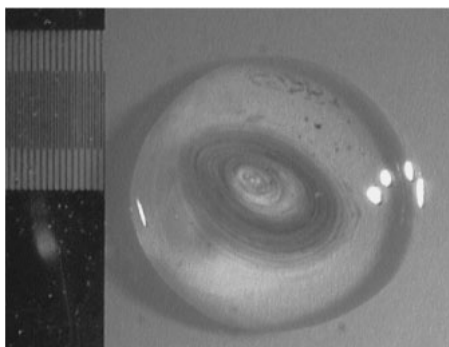

(a)

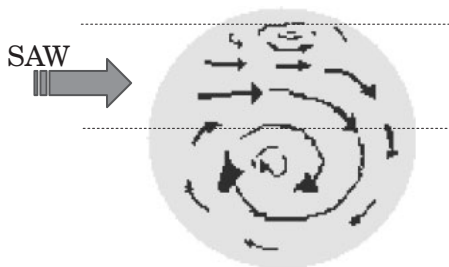

(b)

Fig. 4. Observation results of liquid streaming in 80 wt % glycerol/water droplet, which is not placed at center of SAW propagation path. SAW is excited from left IDT. (a) Photograph and (b) illustration.

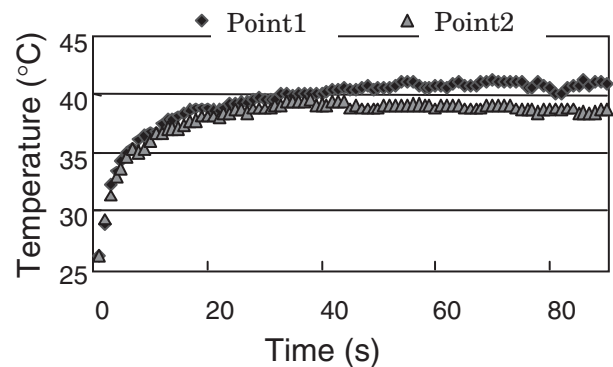

Fig. 6. Time responses of temperature in droplet. SAW is generated from left IDT. Points 1 and 2 are shown in Fig. 3.

temperature). The result is shown in Fig. 6. The temperature at point 2 was lower than that at point 1, due mainly to the attenuation of the radiated longitudinal wave in a high-viscosity droplet. The results suggest that the attenuation of

the longitudinal wave can be obtained by measuring temperature distribution. The droplet, however, was too small for temperature distribution measurement. Also, for low-viscosity solution droplet, it is difficult to bring the droplet to a standstill. For the stable measurement of temperature distribution in liquid, a U-type liquid cell was designed and used.

### 3.3 Measurement of liquid temperature and streaming using U-type liquid cell

The U-type liquid cell was made from a silicone rubber. The size is shown in Fig. 7(a). The U-type cell was placed onto the SAW propagating surface. The gap between IDT and the cell was 1 mm. A 50  $\mu$ l liquid was used to fill the empty region and then a plastic plate was placed on the cell. The plastic plate had a hole through which the thermocouple thermometer was inserted. For measuring the temperature

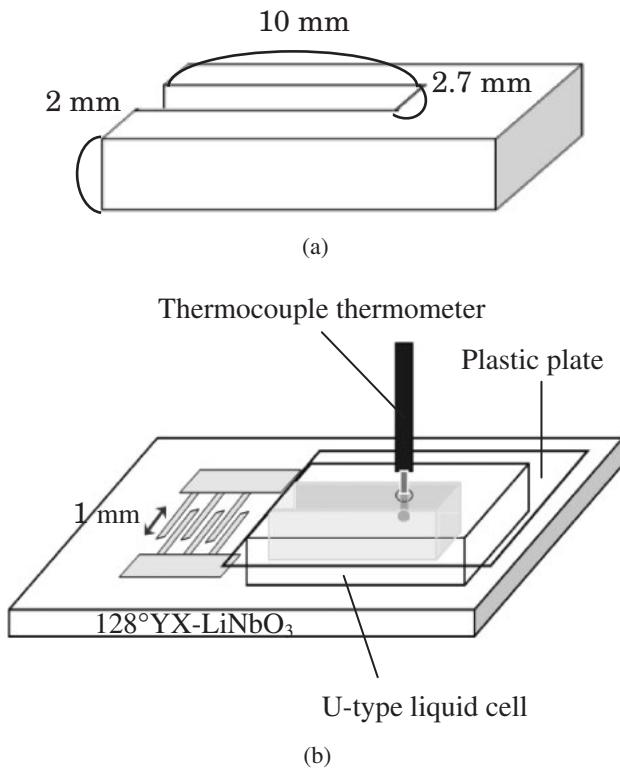

Fig. 7. Schematic illustration of U-type liquid cell system. (a) U-type liquid cell and (b) whole configuration for temperature measurement.

distribution along the propagation direction, we prepared several plates with a hole at made different positions. Applied voltage and pulse frequency were fixed at  $20 V_{p-p}$  and 1 kHz, respectively. The concentration of glycerol/water mixture was varied.

The time responses of temperature are shown in Fig. 8. The initial temperature was  $26^\circ\text{C}$ . For water, transient responses do not depend on the distance from the IDT. On the other hand, for the 80 wt % glycerol/water mixture, those depend on the distance. Also, saturation values decrease with increasing distance. The temperature distribution 90 s after the voltage was applied are summarized in Fig. 9. As the attenuation constant of the longitudinal wave increased with glycerol concentration, maximum temperature increased, which was obtained at 1 mm from the IDT. The gradient of the response curves increased with glycerol concentration. To explain these mechanisms, the liquid flow was visualized for each solution using a CCD camera (magnification,  $\times 20$ ). Ultramarine blue powdered mineral paint was mixed with the liquids. Figure 10 shows the observation result of the 60 wt % glycerol/water mixture after 90 s after voltage was applied. The movement of each mixed paint was observed. The observation results are illustrated in Fig. 11. The flow rates are expressed by arrows. For water, a uniform stream within the IDT aperture, namely the SAW propagation path, was observed. The flow rate was constant against the distance from the IDT. However, the flow rate for the glycerol/water mixtures decreases with increasing glycerol concentration. At a high glycerol concentration, a liquid stream was observed only near the IDT.

We now discuss the behavior of the radiated longitudinal wave using Figs. 9 and 11. The temperature and flow rate of water were constant. For the small attenuation of the

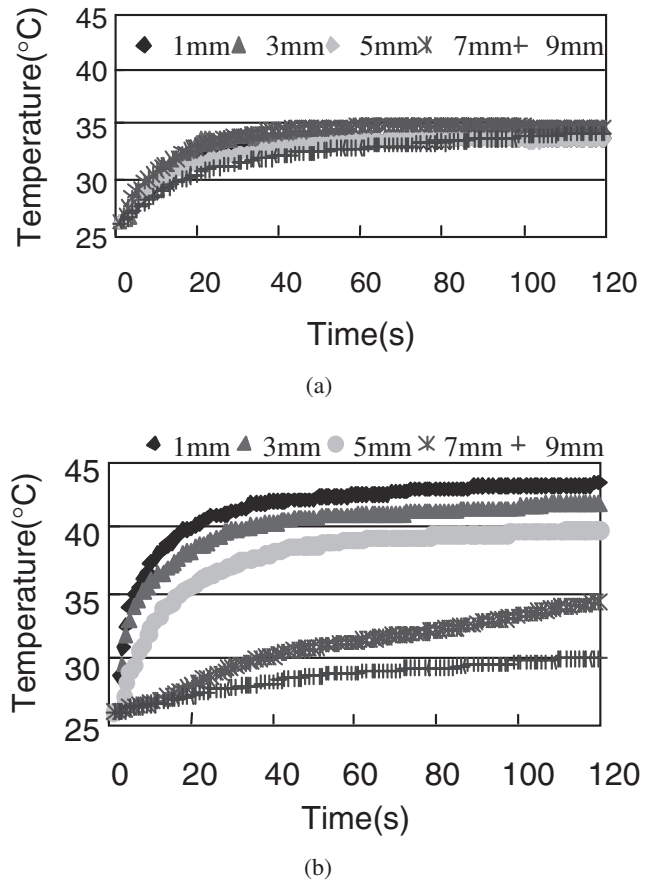

Fig. 8. Time responses of temperature with distance from IDT as parameter. (a) Water and (b) 80 wt % glycerol/water mixture.

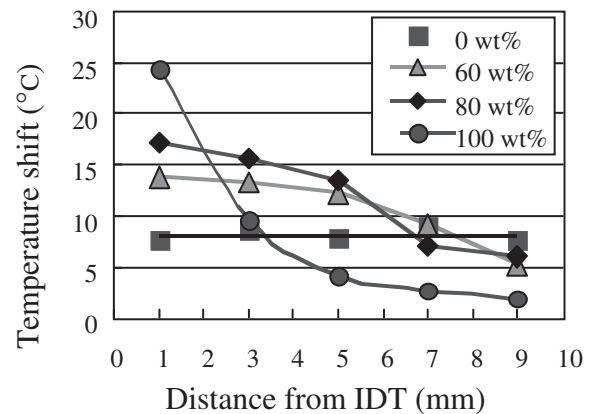

Fig. 9. Temperature distribution in SAW propagation direction 90 s after voltage was applied. The parameter is the concentration of glycerol/water mixture.



Fig. 10. Photograph of liquid streaming in U-type liquid cell 90 s after SAW is generated. The sample is 60 wt % glycerol/water mixture.

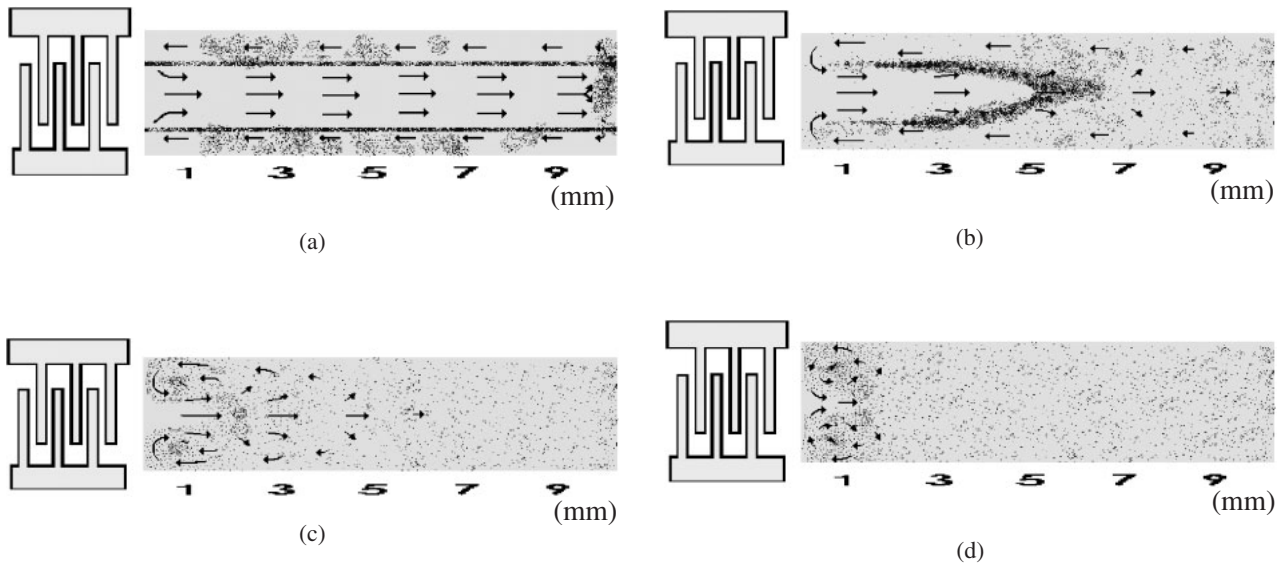

Fig. 11. Illustration of observed results of liquid streaming in U-type liquid cell, 90 s after SAW is generated. (a) Water, (b) 60 wt % glycerol/water mixture, (c) 80 wt % glycerol/water mixture, and (d) glycerol.

longitudinal wave in water, the obtained results were reasonable. The curve in Fig. 9 of the 80 wt % of glycerol mixture has two parts. The slope until 5 mm from the IDT was almost linear and, after 5 mm, temperature decreased rapidly. From Fig. 11(c), as a liquid stream was observed until about 5 mm, the linear decrease in temperature until 5 mm was due to the attenuation of longitudinal wave. After the longitudinal wave was damped, liquid temperature decreased due to heat conduction. Therefore, the relationship between the temperature and the distance beyond 5 mm is exponential. For 100% glycerol, a longitudinal wave cannot propagate and liquid streams were observed only until 1 mm. Therefore, the liquid up to 1 mm was heated and temperature decreased exponentially beyond 1 mm, as shown in Fig. 9. From the results, we conclude that the attenuation of a longitudinal wave can be expected by measuring liquid temperature.

#### 4. Conclusions

In this paper, SAW streaming based on temperature measurement and the observation of liquid streaming was discussed. For agar-agar samples, only water was affected, so no change from gel to sol was observed. The results of the 80 wt % glycerol/water mixture droplet showed that vortices were formed in it. However, it was difficult to measure temperature distribution, because the propagation length of the longitudinal wave in a small droplet (10  $\mu$ l) was not

sufficient. Also, as the low-viscosity droplet moved away, the stable measurement was difficult. Therefore, the U-type liquid cell was fabricated. Using this cell, temperature distribution and liquid streaming were measured. The results indicate that the attenuation of a longitudinal wave can be estimated by detecting liquid temperature. As the temperature of a liquid increases due to a radiated longitudinal wave, the power of SAW streaming, namely SAW streaming forth,<sup>5)</sup> can be estimated from temperature measurement. This is the topic of our future work. For a detailed discussion of SAW streaming, a three-dimensional observation of temperature and streaming is required. Some assumptions are necessary for this purpose.

- 1) M. Kadota: *Jpn. J. Appl. Phys.* **44** (2005) 4285.
- 2) H. L. Bertoni and T. Tamir: *Appl. Phys.* **2** (1973) 157.
- 3) S. Shiokawa, Y. Matsui, and T. Moriizumi: *Proc. 9th Symp. Ultrasonic Electronics, Sendai, 1988*, *Jpn. J. Appl. Phys.* **28** (1989) Suppl. 28-1, p. 126.
- 4) S. Shiokawa, Y. Matsui, and T. Ueda: *Proc. 10th Symp. Ultrasonic Electronics, Tokyo, 1989*, *Jpn. J. Appl. Phys.* **29** (1990) Suppl. 29-1, p. 137.
- 5) S. Shiokawa and Y. Matsui: *Mater. Res. Soc. Symp. Proc.* **360** (1995) 53.
- 6) K. Chono, N. Shimizu, Y. Matsui, J. Kondoh, and S. Shiokawa: *Jpn. J. Appl. Phys.* **43** (2004) 2987.
- 7) J. Kondoh, N. Shimizu, Y. Matsui, M. Sugimoto, and S. Shiokawa: *IEEE Ultrasonic Symp. Proc.*, 2005, p. 1023.