

# Surface Fatigue Lives of Case-Carburized Gears With an Improved Surface Finish

T. L. Krantz

U.S. Army Research Laboratory,  
Glenn Research Center,  
Cleveland, OH 44135

M. P. Alanou

H. P. Evans

R. W. Snidle

Cardiff University,  
P.O. Box 685,  
Cardiff, CF24 3TA,  
Wales, United Kingdom

*Previous research provides qualitative evidence that an improved surface finish can increase the surface fatigue lives of gears. To quantify the influence of surface roughness on life, a set of AISI 9310 steel gears was provided with a near-mirror finish by superfinishing. The effects of the superfinishing on the quality of the gear tooth surfaces were determined using data from metrology, profilometry, and interferometric microscope inspections. The superfinishing reduced the roughness average by about a factor of 5. The superfinished gears were subjected to surface fatigue testing at 1.71 GPa (248-ksi) Hertz contact stress, and the data were compared with the NASA Glenn gear fatigue data base. The lives of gears with superfinished teeth were about four times greater compared with the lives of gears with ground teeth but with otherwise similar quality.*

[DOI: 10.1115/1.1387036]

## Introduction

The power density of a gearbox is an important consideration for many applications and is especially important for gearboxes used on aircraft. One factor that limits gearbox power density is the ability of the gear teeth to transmit power for the required number of cycles without pitting or spalling. Economical methods for improving surface fatigue lives of gears are therefore highly desirable.

Tests of rolling element bearings [e.g., [1,2]] have shown that the bearing life is affected by the lubricant viscosity. When the specific film thickness (the EHL film thickness divided by the composite surface roughness) is less than unity, the service life of the bearing is considerably reduced. Some investigators have anticipated that the effect of specific film thickness on gear life could be even more pronounced than the effect on bearing life [3]. To improve the surface fatigue lives of gears, the EHL film thickness may be increased, the composite surface roughness reduced, or both approaches may be adopted. These two effects have been studied.

Townsend and Shimski [4] studied the influence of seven different lubricants of varying viscosity on gear fatigue lives. Tests were conducted on a set of case-carburized and ground gears, all manufactured from the same melt of consumable-electrode vacuum-melted (CVM) AISI 9310 steel. At least 17 gears were tested with each lubricant. They noted a strong positive correlation of the gear surface fatigue lives with the calculated EHL film thickness and demonstrated that increasing the EHL film thickness does indeed improve gear surface fatigue life.

At least three investigations have been carried out to demonstrate the relation between gear surface fatigue and surface roughness. One investigation by Tanka et al. [5] involved a series of tests conducted on steels of various chemistry, hardness, and states of surface finish. Some gears were provided with a near-mirror finish by using a special grinding wheel and machine [6]. The grinding procedure was a generating process that provided teeth with surface roughness quantified as  $R_{\max}$  of about  $0.1 \mu\text{m}$  ( $4 \mu\text{in.}$ ). A series of pitting durability tests were conducted and included tests of case-carburized pinions mating with both plain carbon steel gears and through-hardened steel gears. They concluded that the gear surface durability was improved in all cases as a result of the near-mirror finish. They noted that when a case-

hardened, mirror-finished pinion was mated with a relatively soft gear, the gear became polished with running. They considered that this polishing during running improved the surface durability of the gear. None of the tests conducted in the study, however, included a case-carburized pinion mated with a case-carburized gear.

A second investigation by Nakasuji et al. [7,8] studied the possibility of improving gear fatigue lives by electrolytically polishing the teeth. They conducted their tests using medium carbon steel gears and noted that the electropolishing process altered the gear profile and the surface hardness as well as the surface roughness. The polishing reduced the surface hardness and changed the tooth profiles to the extent that the measured dynamic tooth stresses were significantly larger relative to the ground gears. Even though the loss of hardness and increased dynamic stresses would tend to reduce stress limits for pitting durability, the electrolytic polishing was shown to improve the stress limit, at which the gears were free of pitting, by about 50 percent.

Hoyashita et al. [9,10] completed a third investigation of the relation between surface durability and roughness. They conducted a set of tests to investigate the effects of shot peening and polishing on the fatigue strength of case-hardened rollers. Some of the shot-peened rollers were reground and some were polished by a process called barrelling. The reground rollers had a roughness average (Ra) of  $0.78 \mu\text{m}$  ( $31 \mu\text{in.}$ ). The polished rollers had a Ra of  $0.05 \mu\text{m}$  ( $2.0 \mu\text{in.}$ ). Pitting tests were conducted using a slide-roll ratio of  $-20$  percent on the follower with mineral oil as the lubricant. The lubricant film thickness was estimated to be  $0.15 \sim 0.25 \mu\text{m}$  ( $5.9 \sim 9.8 \mu\text{in.}$ ). The surface durability of the rollers that had been shot peened and polished by barrelling was significantly improved compared with rollers that were shot peened only or that were shot peened and reground. They found that the pitting limits (maximum Hertz stress with no pitting after  $10^7$  cycles) of the shot-peened/reground rollers and the shot-peened/polished rollers were 2.15 GPa (312 ksi) and 2.45 GPa (355 ksi), respectively.

Patching et al. [11] evaluated the scuffing properties of ground and superfinished surfaces using turbine engine oil as the lubricant. The evaluation was performed using case-carburized steel discs. The discs were finish ground in the axial direction such that the orientation of the roughness would be perpendicular to the direction of rolling and sliding, thereby simulating the conditions normally found in gears. Some of the discs were superfinished to provide smoother surfaces. The Ra of the ground discs was about  $0.4 \mu\text{m}$  ( $16 \mu\text{in.}$ ), and the Ra of the superfinished discs was less

Contributed by the Tribology Division for publication in the ASME JOURNAL OF TRIBOLOGY. Manuscript received by the Tribology Division February 2, 2000; revised manuscript received January 18, 2001. Associate Editor: T. C. Ovaert.

than  $0.1 \mu\text{m}$  ( $4 \mu\text{in.}$ ). They found that compared with the ground discs, the superfinished discs had a significantly higher scuffing load capacity when lubricated with turbine engine oil and subjected to relatively high rolling and sliding speeds. They also noted that under these operating conditions, the sliding friction of the superfinished surfaces was the order of half that for the ground surfaces.

These previous works [1–11] provide strong evidence that the reduction of surface roughness improves the lubricating condition and offers the possibility of increasing the surface fatigue lives of gears. However, there is little published data to quantify the improvement in life for case-carburized gears. The present study was therefore carried out to quantify the surface fatigue lives of aerospace-quality gears that have been provided with an improved surface finish relative to conventionally ground gears.

### Test Apparatus, Specimens, and Procedure

**Gear Test Apparatus.** The gear fatigue tests were performed in the NASA Glenn Research Center's gear test apparatus. The test rig is shown in Fig. 1(a) and described in reference [12]. The rig uses the four-square principle of applying test loads so that the input drive only needs to overcome the frictional losses in the system. The test rig is belt driven and operated at a fixed speed for the duration of a particular test.

A schematic of the apparatus is shown in Fig. 1(b). Oil pressure and leakage replacement flow is supplied to the load vanes through a shaft seal. As the oil pressure is increased on the load vanes located inside one of the slave gears, torque is applied to its shaft. This torque is transmitted through the test gears and back to the slave gears. In this way power is recirculated and the desired load and corresponding stress level on the test gear teeth may be obtained by adjusting the hydraulic pressure. The two identical test gears may be started under no load, and the load can then be applied gradually. This arrangement also has the advantage that changes in load do not affect the width or position of the running track on the gear teeth. The gears are tested with the faces offset as shown in Fig. 1. By utilizing the offset arrangement for both faces of the gear teeth, a total of four surface fatigue tests can therefore be run for each pair of gears.

Separate lubrication systems are provided for the test and slave gears. The two lubrication systems are separated at the gearbox shafts by pressurized labyrinth seals, with nitrogen as the seal gas. The test gear lubricant is filtered through a  $5 \mu\text{m}$  ( $200 \mu\text{in.}$ ) nominal fiberglass filter. A vibration transducer mounted on the gearbox is used to automatically stop the test rig when gear surface fatigue damage occurs. The gearbox is also automatically stopped if there is a loss of oil flow to either the slave gearbox or the test gears, if the test gear oil overheats, or if there is a loss of seal gas pressurization.

**Test Specimens.** The gears of the present study were manufactured from consumable-electrode vacuum-melted (CVM) AISI 9310 steel. The best available baseline for this study is a set of conventionally ground gears that were previously tested and the data reported [4]. The test gears used for the baseline study of Ref.

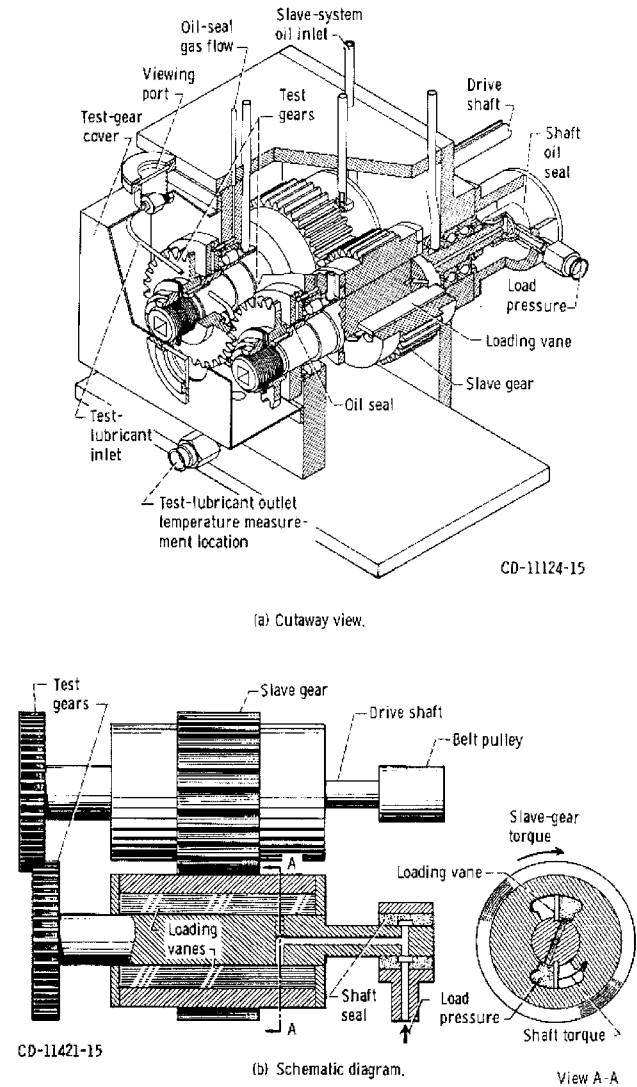

**Fig. 1 NASA Glenn Research Center gear fatigue test apparatus: (a) cutaway view; (b) schematic view.**

[4] were manufactured from a separate melt of consumable-electrode vacuum-melted (CVM) AISI 9310 steel. Both sets of gears were case carburized and ground. The nominal and certified chemical compositions of the gears are given in Table 1. Figures 2(a) to (d) are photomicrographs showing the microstructure of the case and core. Figure 3 is a plot of material hardness versus depth below the pitch radius surface. The data of Fig. 3 are equivalent Rockwell C scale hardness values converted from

**Table 1 Nominal and certified chemical composition of gear materials, AISI 9310**

	Element									
	C	Mn	P	S	Si	Ni	Mo	Cr	Cu	Fe
Nominal contents, wt %	0.10	0.63	0.005	0.005	0.27	3.22	0.12	1.21	0.13	Balance
Ground gear, certified contents, wt %	0.10	0.56	0.003	0.003	0.26	3.49	0.10	1.15	*	*
Superfinished gear, certified contents, wt %	0.11	0.55	0.006	0.018	0.26	3.42	0.10	1.30	*	*

\*Indicates not measured.

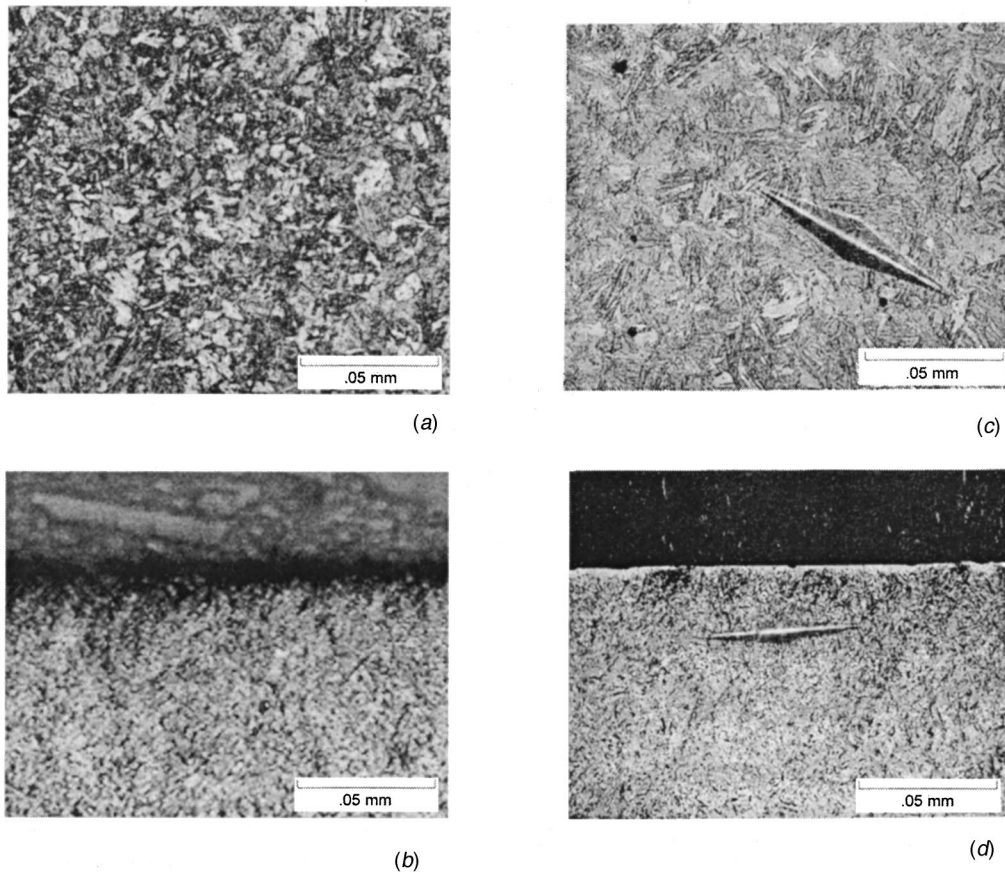

Fig. 2 Microphotographs of the gears prepared with 3 percent nital etch: (a) core of superfinished gear; (b) case of superfinished gear; (c) core of ground gear (from Ref. [4]); and (d) case of ground gear (from Ref. [4]).

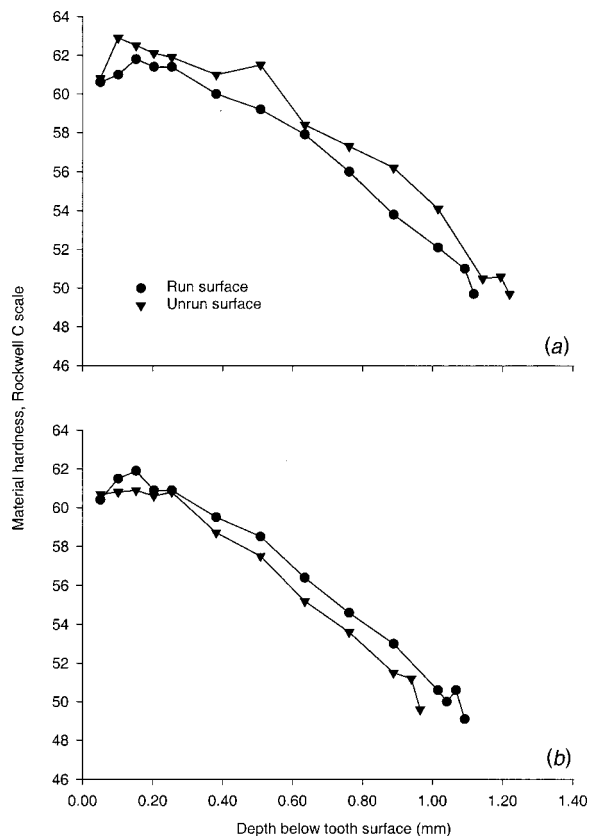

Fig. 3 Material hardness versus depth below the pitch radius surface: (a) superfinished gear; (b) ground gear.

Knopp microhardness data. These data and metrology inspections [13] verify that the gear materials and geometry are aerospace quality.

The dimensions of the gears are given in Table 2. The gears are 3.175 mm module (8 diametral pitch) and have a standard 20 deg involute pressure angle with tip relief of 0.013 mm (0.0005 in.) starting at the highest point of single tooth contact. The nominal face width is 6.35 mm (0.250 in.), and the gears have a nominal 0.13 mm (0.005 in.) radius edge break to avoid edge loading.

Fourteen gears were selected for finishing by a polishing method described below. A subset of four gears was selected at random for metrology inspections, both before and after superfinishing. Parameters measured on each gear included lead and profile errors, adjacent pitch errors, and mean circular tooth thickness. In order to show the detailed effects of superfinishing, it was

Table 2 Spur gear data (gear tolerance per AGMA class 12)

Number of teeth	28
Module, mm	3.175
Diametral pitch	8
Circular pitch, mm (in.)	9.975 (0.3927)
Whole depth, mm (in.)	7.62 (0.300)
Addendum, mm (in.)	3.18 (.125)
Chordal tooth thickness reference, mm (in.)	4.85 (0.191)
Pressure angle, deg.	20
Pitch diameter, mm (in.)	88.90 (3.500)
Outside diameter, mm (in.)	95.25 (3.750)
Root fillet, mm (in.)	1.02 to 1.52 (0.04 to 0.06)
Measurement over pins, mm (in.)	96.03 to 96.30 (3.7807 to 3.7915)
Pin diameter, mm (in.)	5.49 (0.216)
Backlash reference, mm (in.)	0.254 (0.010)
Tip relief, mm (in.)	0.010 to 0.015 (0.0004 to 0.0006)



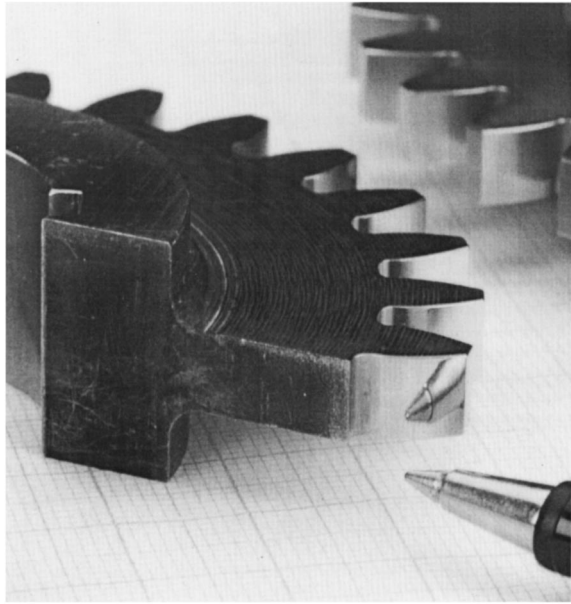
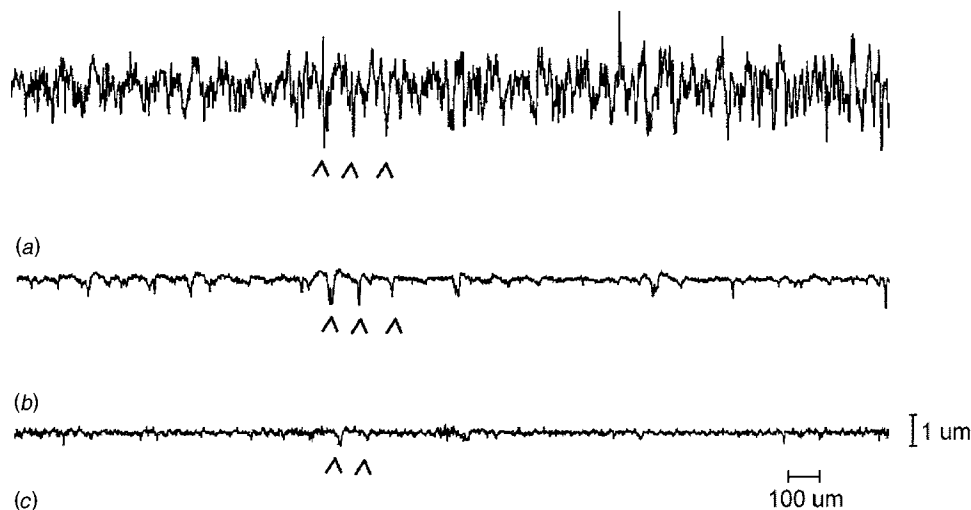

**Fig. 4 Near-mirror quality of superfinished tooth surface**

decided to also take “relocated” profiles from the gear teeth. This was achieved by use of a special stepper-motor-driven profilometer with which it was possible to take a profile or series of profiles at a precisely known location on a gear tooth. The principle of relocation was based on detection of the edges of the tooth by running the profilometer stylus in the axial direction of the gear to detect the side of the tooth and radially to detect the tooth tip. Three profiles were taken from both sides of two teeth on each gear (i.e., a total of 12 profiles from each gear). Two of the three profiles on each gear flank were located 1 mm (0.039 in.) from each side edge and the third profile was located on the center of the tooth. Profile data was taken up to and slightly beyond the tip of the teeth as a direct means of verifying the accuracy of relocation in every case. All profiles were processed using a standard phase-corrected digital filter with a cutoff of 0.08 mm (0.003 in.).

Superfinishing treatment of the gears was completed as follows. The gears were immersed in a bed of small zinc chips, water, and aluminum oxide powder. The container (a rubber-lined open tank) was vibrated for a period of several hours and the grade of the oxide powder was increased in fineness in three stages. Upon completion of the initial superfinish treatment, metrology inspections were carried out and relocated profiles were taken. Although the surface finish had been improved, grinding marks were still visible on some teeth. The gears were then subjected to a second superfinish treatment. After the second treatment, the gears had a superb near-mirror finish (Fig. 4), and grinding marks were no longer visible. Following the second (final) superfinish treatment, metrology and profilometry inspections were again completed. A detailed report of the superfinish treatment and inspections is available [13]. From analysis of the metrology data, it was concluded that the superfinishing treatment did not significantly alter the lead and involute profile traces of the gear teeth.

Figure 5 is a typical comparison of the relocated surface profiles of the same tooth taken first after grinding, a second time after the initial superfinish treatment, and a third time after the final superfinish treatment. The profile taken after the first stage of superfinishing (Fig. 5(b)) shows a persistence of identifiable grinding marks. These have almost disappeared from the profile taken after the final superfinish treatment (Fig. 5(c)), although there are faint signs of particularly deep marks. Analysis of the profilometry data suggested that about  $1\ \mu\text{m}$  ( $39\ \mu\text{in.}$ ) had been removed from each surface following the initial superfinish treatment and in total, about 2 to  $3\ \mu\text{m}$  ( $79\ \text{to}\ 118\ \mu\text{in.}$ ) had been removed from the surface following the final stage of treatment. These estimates of material removed, as derived from the profilometry data, agree with estimates obtained from metrology measurements of the mean circular tooth thickness taken before and after finishing [13]. The roughness average (Ra) and 10-point parameter (Rz) values for each profile inspection were calculated using the profilometry data filtered with a cutoff of 0.08 mm (0.003 in.). Table 3 is a statistical summary of the calculated Ra and Rz values. Before superfinishing, the gears had a mean Ra of  $0.380\ \mu\text{m}$  ( $15\ \mu\text{in.}$ ) and a mean Rz of  $3.506\ \mu\text{m}$  ( $138\ \mu\text{in.}$ ). After superfinishing, the gears had a mean Ra of  $0.071\ \mu\text{m}$  ( $2.8\ \mu\text{in.}$ ) and a mean Rz of  $0.940\ \mu\text{m}$  ( $37\ \mu\text{in.}$ ). Therefore, the mean Ra and mean Rz values were reduced by a factor of about 5 and 4, respectively, by superfinishing.



**Fig. 5 Typical relocated surface features measured using a profilometer followed by filtering of the data using a 0.08 mm (0.003 in.) cutoff. Evidence of persistence of the deepest grinding marks are indicated by arrows: (a) ground tooth surface,  $R_a=0.434\ \mu\text{m}$  ( $17\ \mu\text{in.}$ ) (b) same tooth surface after the first stage of superfinishing,  $R_a=0.083\ \mu\text{m}$  ( $3.3\ \mu\text{in.}$ ); (c) same tooth after second (final) stage of superfinishing,  $R_a=0.056\ \mu\text{m}$  ( $2.23\ \mu\text{in.}$ ).**

**Table 3 Summary of statistical analysis of profilometry data**

Parameter	Surface condition	Mean value, $\mu\text{m}$ ( $\mu\text{in.}$ )	Standard deviation, $\mu\text{m}$ ( $\mu\text{in.}$ )
Roughness average (Ra)	Before superfinishing	0.380 (15.0)	0.068 (2.7)
	After superfinished	0.070 (2.8)	0.016 (0.6)
10-point parameter (Rz)	Before superfinishing	3.506 (138.0)	0.610 (24.0)
	After superfinished	0.940 (37.0)	0.298 (11.7)

<sup>a</sup>Data are based on relocated and filtered profile measurements of the same teeth, both before and after superfinishing.

A ground gear tooth and a superfinished gear tooth were inspected using a mapping interferometric microscope. Data from the microscope were low pass filtered to remove instrument noise and were further processed to remove the datum. Figure 6 is a comparison of the processed interferometric data. The images of Figs. 6(a) and (b) are not images of the same gear before and after superfinishing but are images from two separate gears. These images provide examples of features of typical ground and superfinished surfaces. Figure 6(b) shows that traces of the original grinding marks are still evident after superfinishing, but the depths of the marks are greatly reduced.

**Test Procedure.** The lubricant used was developed for helicopter gearboxes under the specification DOD-L-85734. This is a 5-cSt lubricant of a synthetic polyol-ester base stock with an

tiwear additive package. Lubricant properties gathered from references [4] and [14] are provided in Table 4.

The test gears were run with the tooth faces offset by a nominal 3.3 mm (0.130 in.) to give a surface load width on the gear face of 3.0 mm (0.120 in.). The actual tooth face offset for each test is based on the measured face width of the test specimen, and the offset is verified upon installation using a depth gage. The nominal 0.13 mm (0.005 in.) radius edge break is allowed for to calculate load intensity. All tests were run-in at a load (normal to the pitch circle) per unit width of 123 N/mm (700 lb/in.) for 1 hour. The load was then increased to 580 N/mm (3300 lb/in.), which resulted in a 1.71 GPa (248 ksi) pitch-line maximum Hertz stress. At the pitch-line load, the tooth bending stress was 0.21 GPa (30 ksi) if plain bending was assumed. However, because there was an

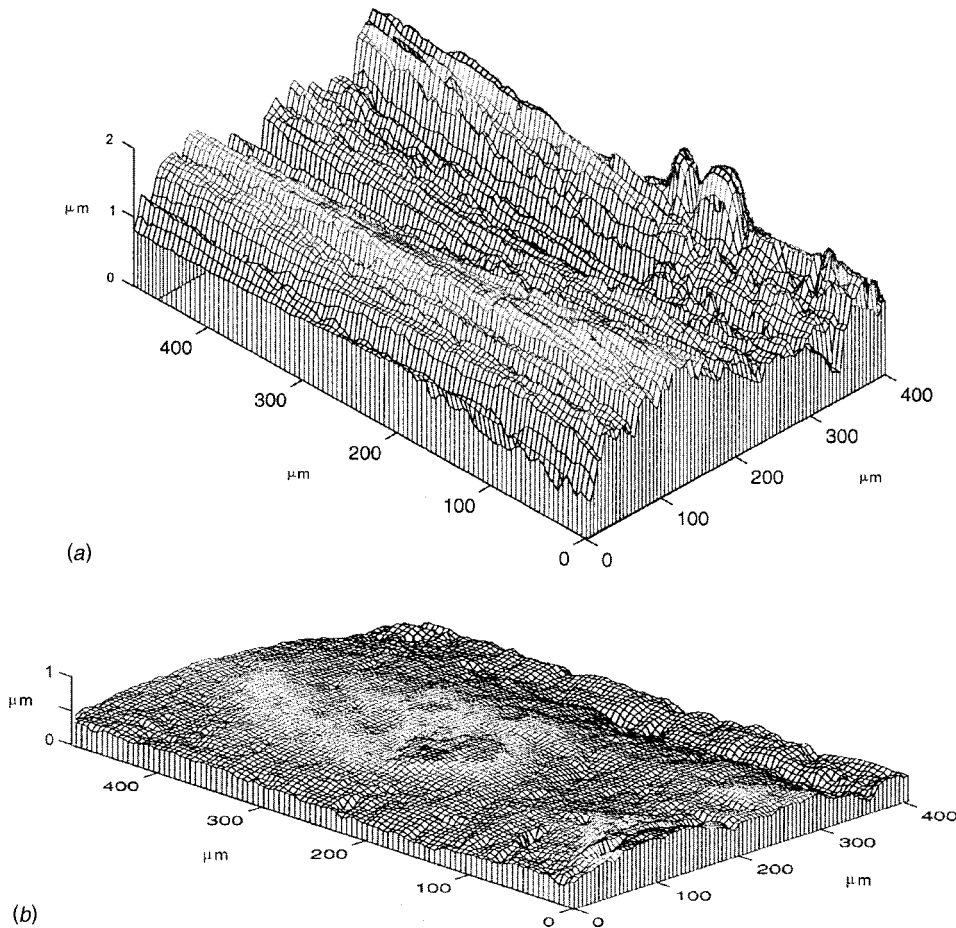

**Fig. 6 Comparison of gear tooth surface topographies as measured using a mapping interferometric microscope: (a) ground gear tooth; (b) superfinished gear tooth.**

**Table 4 Lubricant properties (from Refs. [4] and [14])**

Specification	DOD-L-85734
Basestock	Polyol-ester
Kinematic viscosity, cSt	
311 K (100 °F)	27.6
372 K (210 °F)	5.18
Absolute viscosity, N·s/m <sup>2</sup>	
333 K (140 °F)	0.01703
355 K (180 °F)	0.00738
372 K (210 °F)	0.00494
Specific gravity	
289 K (60 °F)	0.995
372 K (210 °F)	0.954
Pressure viscosity coefficient (1/Pa)	
313 K (104 °F)	11.4 x 10 <sup>-9</sup>
373 K (212 °F)	9.5 x 10 <sup>-9</sup>
Total acid number (tan), Mg Koh/g oil	0.40
Flash point, K (°F)	544 (520)
Pour point, K (°F)	211 (-80)

offset load, there was an additional stress imposed on the tooth bending stress. The combined effects of the bending and torsional moments yield a maximum stress of 0.26 GPa (37 ksi). The effects of tip relief and dynamic load were not considered for the calculation of stresses.

The gears were tested at 10,000 rpm, which gave a pitch-line velocity of 46.5 m/s (9154 ft/min). Inlet and outlet oil temperatures were continuously monitored. Lubricant was supplied to the inlet of the gear mesh at 0.8 liter/min (49 in.<sup>3</sup>/min) and 320 ± 7 K (116 ± 13 °F). The lubricant outlet temperature was recorded and observed to have been maintained at 348 ± 4.5 K (166 ± 8 °F). The tests ran continuously (24 hr/day) until a vibration detection transducer automatically stopped the rig. The transducer is located on the gearbox adjacent to the test gears. If the gears operated for 500 hours (corresponding to 300 million stress cycles) without failure, the test was suspended. The lubricant was circulated through a 5 μm (200 μin.) nominal fiberglass filter to remove wear particles. For each test, 3.8 liter (1 gal) of lubricant was used.

The EHL film thickness at the pitch point for the operating conditions of the surface fatigue testing was calculated using the computer program EXTERN. This program, developed at the NASA Glenn Research Center, is based on the methods of Refs. [15] and [16]. For the purposes of the calculation, the gear surface temperature was assumed to be equal to the average oil outlet temperature. This gave a calculated EHL pitch-line film thickness of 0.54 μm (21 μin.).

## Results and Discussion

Surface fatigue testing was completed on a set of gears manufactured from CVM AISI 9310 steel. The gears were case carburized, ground, and superfinished. The measured Ra of the superfinished gears was 0.071 μm (2.8 μin.). Gear pairs were tested until failure or until 300 million stress cycles (500 hr of testing) had been completed with no failure. The test conditions were a load per unit width of 580 N/mm (3300 lb/in.), which resulted in a 1.71-GPa (248-ksi) pitch-line maximum Hertz stress. For purposes of this work, we defined failure as one or more spalls or pits covering at least 50 percent of the width of the Hertzian line contact on any one tooth. Examples of fatigue damage are shown in Fig. 7. Figure 7 also provides scaled measures of the running tracks. The actual widths of the running tracks varies slightly from test to test depending on the exact geometry of the edge break radius provided to prevent edge loading.

To provide a baseline for the present study, the data from Ref. [4] were selected as the most appropriate available. The tests of Ref. [4] were conducted using the same rigs, lubricant, tempera-

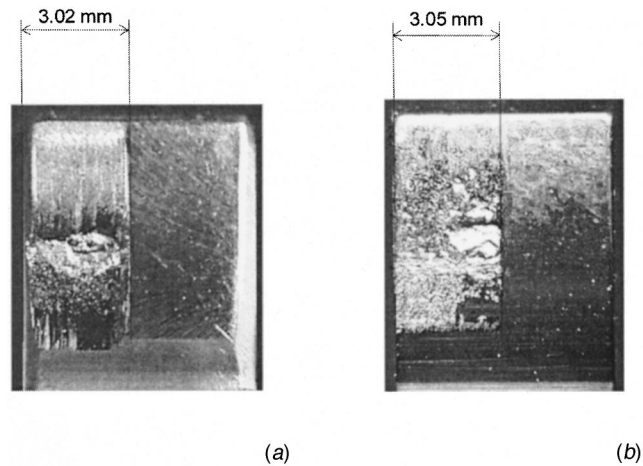

**Fig. 7 Typical fatigue damage: (a) ground gear from study of Ref. [4]; (b) superfinished gear of present study.**

tures, loads, speeds, material specification, and geometry specifications as the present study. The gears of Ref. [4] were specified to be ground with a maximum root-mean-squared roughness of 0.406 μm (0.016 μin.). There were 17 failures and 3 suspended tests for the ground gears of the baseline study, and there were 8 failures and 7 suspended tests for the ground and superfinished gears of the present study. The test data were analyzed by considering the life of each pair of gears as a system. The data were analyzed with the methods of Ref. [17].

Surface fatigue test results for the ground gears of the baseline study are shown in Fig. 8(a). The line shown in Fig. 8(a) is a least-squares linear fit of the data to a two-parameter Weibull distribution. From the fit line, the 10 and 50 percent lives of the sample population are 12 × 10<sup>6</sup> and 51 × 10<sup>6</sup> stress cycles. Surfaces that had been run but were not pitted or spalled had a different appearance relative to the appearance before testing. The grinding marks had become worn away and/or smeared, and the running tracks on the gears were plainly evident (Fig. 7(a)).

Surface fatigue test results for the ground and superfinished gears of the present study are shown in Fig. 8(b). The line shown in Fig. 8(b) is a least-squares linear fit of the data to a two-parameter Weibull distribution. From the fit line, the 10 and 50 percent lives of the sample population are 46 × 10<sup>6</sup> and 205 × 10<sup>6</sup> stress cycles. Superfinished surfaces that had been run and survived with no fatigue failure appeared almost like surfaces that had not been run. The running tracks on the gears were not immediately evident but could be seen by close examination with a 10x eyepiece. The wear and/or smearing that were seen on the ground gears after testing were not observed on the tested superfinished gears.

The surface fatigue test results are summarized in Table 5 and Figs. 8(c) and (d). Figure 8(c) shows the two least-squares linear fit lines on one plot. The Weibull slopes are nearly equal, and therefore the gears have similar relative failure distributions. Figure 8(d) shows the distributions of fatigue lives plotted using linear axes. This plot shows that for a given reliability, the lives of the superfinished gears are greater than the lives of the ground gears. One significant result of the statistical analysis is that the 10 percent life of the set of ground and superfinished gears was greater than the 10-percent life of the set of ground gears to a 91 percent confidence level. In general, the life of the set of ground and superfinished gears was about four times greater than the life of the set of ground gears. In this study, the difference in life can be attributed to the combined effects of (a) the gears being made from different melts of steel and (b) the superfinished gear teeth surface having significantly different topographies.

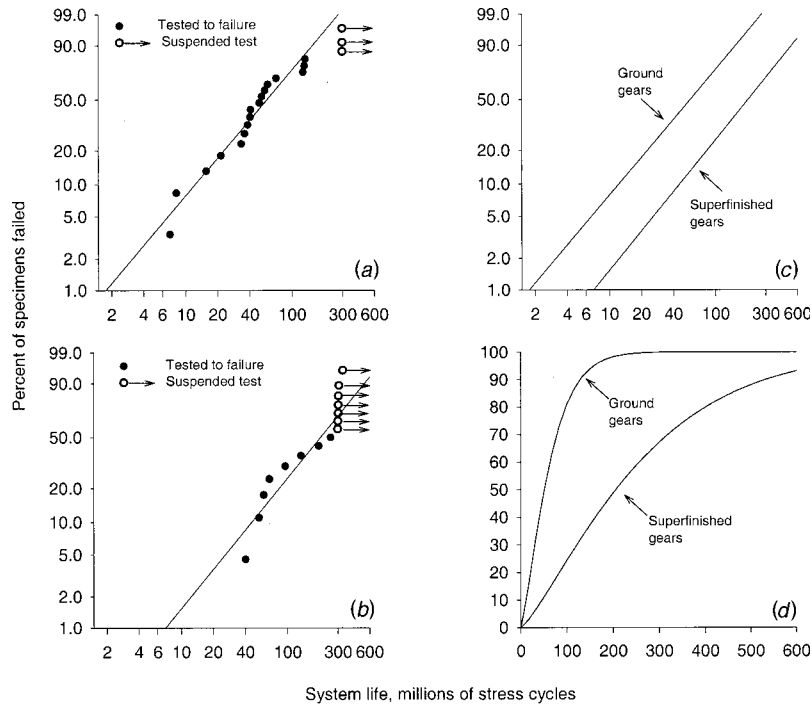

**Fig. 8 Surface fatigue lives of ground and superfinished AISI 9310 gear pairs: (a) ground gears of Ref. [4]; (b) superfinished gears; (c) summary of linear least-square fit lines; and (d) linear least-squares-fit lines plotted on linear axes.**

**Table 5 Fatigue life results for test gears**

Gears	10-percent life, cycles	50-percent life, cycles	Weibull slope	Failure index <sup>a</sup>	Confidence number, percent <sup>b</sup>
CVM AISI 9310, ground [ref. 4]	$12 \times 10^6$	$51 \times 10^6$	1.3	17/20	---
CVM AISI 9310, superfinished	$46 \times 10^6$	$205 \times 10^6$	1.3	8/15	91

<sup>a</sup>Indicates the number of failures out of the number of tests.

<sup>b</sup>Probability, expressed as a percentage, that the 10-percent life of the superfinished gears is greater than the 10-percent life of the ground gears.

**Table 6 Surface fatigue lives of case-carburized AISI 9310 gear pairs tested in the NASA Glenn Research Center gear fatigue test apparatus (pitch-line Hertz stress, 1.71 GPa (248 ksi), 10,000 rpm; oil outlet temperature maintained at  $348 \pm 4.5$  K ( $166 \pm 8^\circ$ F); 5  $\mu$ m (200  $\mu$ in.) nominal fiberglass filter to remove wear debris; gear geometry, AGMA class 12, 8 pitch, 28 teeth).**

Reference	Year published	Material	Lubricant specification or description	10-Percent life, cycles <sup>a</sup>	50-Percent life, cycles <sup>a</sup>	Weibull slope	Failure index <sup>b</sup>	Comments
18	1985	CVM AISI 9310	MIL-L-23699	$4.8 \times 10^6$	$26 \times 10^6$	1.1	20/20	Ground
19	1984	CVM AISI 9310	Tetraester plus additives (see ref.)	$7.6 \times 10^6$	$31 \times 10^6$	1.3	30/30	Ground
19	1984	CVM AISI 9310	Tetraester plus additives (see ref.)	$9.3 \times 10^6$	$66 \times 10^6$	1.0	22/23	Ground
20	1975	CVM AISI 9310	Super-refined mineral oil plus additives	$11 \times 10^6$	$24 \times 10^6$	2.6	19/19	Ground
4	1994	CVM AISI 9310	MIL-L-23699	$12 \times 10^6$	$76 \times 10^6$	1.0	20/20	Ground
4	1994	CVM AISI 9310	DOD-L-85734	$12 \times 10^6$	$51 \times 10^6$	1.3	17/20	Ground, most direct comparison with present study
19	1984	CVM AISI 9310	Tetraester plus additives (see ref.)	$13 \times 10^6$	$74 \times 10^6$	1.1	21/21	Ground
18	1985	CVM AISI 9310	Dibasic acid ester gear lubricant	$19 \times 10^6$	$44 \times 10^6$	2.2	20/20	Ground
21	1982	CVM AISI 9310	NASA standard	$19 \times 10^6$	$46 \times 10^6$	2.1	18/18	Ground
19	1984	CVM AISI 9310	Tetraester plus additives (see ref.)	$20 \times 10^6$	$67 \times 10^6$	1.6	20/20	Ground
22	1995	CVM AISI 9310	NASA standard	$21 \times 10^6$	$45 \times 10^6$	2.4	19/20	Ground
23	1980	CVM AISI 9310	NASA standard	$23 \times 10^6$	$52 \times 10^6$	2.3	30/30	Ground
18	1985	CVM AISI 9310	GM 6137-M	$23 \times 10^6$	$54 \times 10^6$	2.2	20/20	Ground
18	1985	CVM AISI 9310	MIL-L-23699 - type II	$25 \times 10^6$	$38 \times 10^6$	4.5	18/18	Ground
21	1982	CVM AISI 9310	NASA standard	$30 \times 10^6$	$68 \times 10^6$	2.3	24/24	Ground, shot peened.
24	1992	VIM-VAR AISI 9310	NASA standard	$42 \times 10^6$	$140 \times 10^6$	1.6	14/20	Ground, medium-intensity shot peened
25	1989	VIM-VAR AISI 9310	NASA standard	$48 \times 10^6$	$200 \times 10^6$	1.3	24/33	Ground
24	1992	VIM-VAR AISI 9310	NASA standard	$89 \times 10^6$	$250 \times 10^6$	1.9	13/20	Ground, high-intensity shot peened
N/A	2000	CVM AISI 9310	DOD-L-85734	$46 \times 10^6$	$205 \times 10^6$	1.3	8/15	Ground and superfinished (present study)

<sup>a</sup>The 10-percent and 50-percent lives are those obtained by fitting the test data to two-parameter Weibull distributions. The lives are system lives, the system being a pair of gears.

<sup>b</sup>Indicates the number of failures out of the number of tests. A test was suspended after  $300 \times 10^6$  cycles if no failure occurred



To help assess the influence of the superfinishing on life, the results of the present study can be compared in a qualitative sense to the NASA Glenn gear fatigue data base. Table 6 [18–25] is a summary of the majority of published test results of testing AISI 9310 gears using the NASA Glenn gear fatigue test apparatus (Fig. 1). Common to all data presented in Table 6 are (a) tests completed using the same rigs, (b) test gear geometry per Table 2, (c) ground surface finish specified as maximum root-mean-squared roughness of  $0.406\ \mu\text{m}$  ( $0.016\ \mu\text{in}$ ), (d) load of 1.71 GPa (248 ksi) Hertz contact stress at the pitch line, (e) test gears run in an offset condition with a 3.3 mm (0.130 in.) nominal tooth surface overlap, (f) operating speed of 10,000 rpm; (g) lubricant filtered using a  $5\ \mu\text{m}$  ( $200\ \mu\text{in}$ .) nominal filter to remove wear debris; (h) lubricant outlet temperature maintained at  $348 \pm 4.5\ \text{K}$  ( $166 \pm 8^\circ\text{F}$ ); and (i) the test data treated as failures of a system of two gears and then fitted to a two-parameter Weibull distribution using the linear least-squares method. The 10 and 50 percent lives listed in Table 6 are those of the least-squares fit lines. The table is sorted in ascending order of 10 percent lives, except the data of the present study occupies the last row of the table. The data of Table 6 were produced using gears manufactured from several melts of steel, having various processing (such as shot peening), and lubricated with several different lubricants with viscosities (at 373 K ( $212^\circ\text{F}$ )) ranging from 5.1–7.7 cSt. The ground and superfinished gears of the present study had lives greater than those of any other set of single-vacuum processed AISI 9310 gears tested to date. The lives of the CVM AISI 9310 superfinished gears were of the order of magnitude of ground VIM-VAR AISI 9310 gears. The proportion of the gears operating for 300 million cycles without failure was considerably higher than that for any of the other gears tested.

Considering the quantitative differences in the data of Table 5, the qualitative comparisons made using the data of Table 6, and the observed differences in appearances of the tested ground and superfinished surfaces, there is strong evidence that superfinishing significantly improves the surface fatigue lives of case-carburized and ground aerospace-quality AISI 9310 gears.

## Conclusions

A set of consumable-electrode vacuum-melted (CVM) AISI 9310 steel gears were ground and then provided with a near-mirror quality tooth surface by superfinishing. The gear tooth surface qualities were evaluated using metrology inspections, profilometry, and a mapping interferometric microscope. The gears were tested for surface fatigue in the NASA Glenn gear fatigue test apparatus at a load of 1.71 GPa (248 ksi) and at an operating speed of 10,000 rpm until failure or until survival of 300 million stress cycles. The lubricant used was a polyol-ester base stock meeting the specification DOD-L-85734. The failures were considered as failures of a two-gear system, and the data were fitted to a two-parameter Weibull distribution. The results of the present study were compared with the NASA Glenn gear fatigue data base. The following results were obtained.

1 The superfinishing treatment removed about 2 to 3  $\mu\text{m}$  (79 to 118  $\mu\text{in}$ .) of material from the tooth surfaces.

2 The superfinishing treatment reduced the mean roughness average (Ra) by a factor of about 5 and the mean 10 point parameter (Rz) value by a factor of about 4.

3 The 10 percent life of the set of ground and superfinished gears of the present study was greater than the 10-percent life of the set of ground gears of the baseline study to a 91 percent confidence level.

4 In general, the life of the set of ground and superfinished gears of the present study was about 4 times greater than the life of the set of ground gears of the baseline study.

5 The set of ground and superfinished gears of the present study had lives greater than those of any other set of single-vacuum processed AISI 9310 gears tested to date using the NASA Glenn gear fatigue test apparatus.

6 The proportion of the gears operating for 300 million cycles without failure was considerably higher for the superfinished gears than was the proportion for any other set of ground AISI 9310 gears tested to date using the NASA Glenn gear fatigue test apparatus.

7 The lives of the CVM AISI 9310 ground and superfinished gears of the present study were of the order of magnitude of VIM-VAR AISI 9310 ground gears when tested using the NASA Glenn gear fatigue test apparatus.

8 There is strong evidence that superfinishing significantly improves the surface fatigue lives of case-carburized, ground, aerospace-quality AISI 9310 gears.

## References

- Anderson, W. J., Parker, R. J., and Zaretsky, E. V., 1962, "Effect of Nine Lubricants on Rolling-Contact Fatigue Life," NASA TN D-1404.
- Anderson, W. J., Sibley, L. B., and Zaretsky, E. V., 1963, "The Role of Elastohydrodynamic Lubrication in Rolling-Contact Fatigue," *J. Basic Eng.*, **85**, pp. 439–450.
- Townsend, D. P., and Shimski, J., 1991, "Evaluation of Advanced Lubricants for Aircraft Applications Using Gear Surface Fatigue Tests," NASA TM-104336.
- Townsend, D. P., and Shimski, J., 1994, "Evaluation of the EHL Film Thickness and Extreme Pressure Additives on Gear Surface Fatigue Life," NASA TM-106663.
- Tanaka, S., Ishibashi, A., and Ezoe, S., 1984, "Appreciable Increases in Surface Durability of Gear Pairs With Mirror-Like Finish," ASME Publication 84-DET-223, ASME, New York, NY.
- Ishibashi, A., Ezoe, S., and Tanaka, S., 1984, "Mirror Finishing of Tooth Surfaces Using a Trial Gear Grinder With Cubic-Born-Nitride Wheel," ASME Publication 84-DET-153, ASME, New York, NY.
- Nakatsuji, T., Mori, A., and Shimotsuma, Y., 1995, "Pitting Durability of Electrolytically Polished Medium Carbon Steel Gears," *Tribol. Trans.*, **38**, No 2, pp. 223–232.
- Nakatsuji, T., and Mori, A., 1999, "Pitting Durability of Electrolytically Polished Medium Carbon Steel Gears—Succeeding Report," *Tribol. Trans.*, **42**, No 2, pp. 393–400.
- Hoyashita, S., Hashimoto, M., and Seto, K., 1998, "Basic Studies on Fatigue Strength of Case-Hardened Gear Steel—Effects of Shot Peening and/or Barrelling Processes," AGMA Publication 98FTM3.
- Hashimoto, M., Hoyashita, S., and Iwata, J., 1998, "Studies on Improvement of Surface Durability of Case-Carburized Steel Gear—Effects of Surface Finish Processes upon Oil Film Formation," AGMA Publication 98FTM9.
- Patching, M. J., Kweh, C. C., Evans, H. P., and Snidle, R. W., 1995, "Conditions for Scuffing Failure of Ground and Superfinished Steel Disks at High Sliding Speeds Using a Gas Turbine Engine Oil," *ASME J. Tribol.*, **117**, No 3, pp. 482–489.
- Townsend, D. P., Chevalier, J. L., and Zaretsky, E. V., 1973, "Pitting Fatigue Characteristics of AISI M-50 and Super Nitralloy Spur Gears," NASA TN D-7261.
- Snidle, R. W., Evans, H. P., and Alanou, M. P., 1997, "The Effect of Superfinishing on Gear Tooth Profile," AD-A327916, Defense Technical Information Center, Ft. Belvoir, VA. Also available from NASA Scientific and Technical Information Center, <http://www.sti.nasa.gov/> accessed October 3, 2000.
- Present, D. L., Newman, F. M., Tyler, J. C., and Cuellar, J. P., 1983, "Advanced Chemical Characterization and Physical Properties of Eleven Lubricants," NASA CR-168187.
- Anderson, N. E., Lowenthal, S. H., and Black, J. D., 1984, "An Analytical Method to Predict Efficiency of Aircraft Gearboxes," NASA TM-83716 (AIAA Paper 84-1500).
- Anderson, N. E., and Lowenthal, S. H., 1980, "Spur-Gear-System at Part and Full Load," NASA TP-1622.
- Johnson, L. G., 1964, *The Statistical Treatment of Fatigue Experiments*, Elsevier Publishing Co., New York, NY.
- Townsend, D. P., and Zaretsky, E. V., 1985, "Effect of Five Lubricants on Life of AISI 9310 Spur Gears," NASA TP-2419.
- Scibbe, H. W., Townsend, D. P., and Aron, P. R., 1984, "Effect of Lubricant Extreme-Pressure Additives on Surface Fatigue Life of AISI 9310 Spur Gears," NASA TP-2408.
- Coy, J. J., Townsend, D. P., and Zaretsky, E. V., 1975, "Analysis of Dynamic Capacity of Low-Contact-Ratio Spur Gears Using Lundberg-Palmgren Theory," NASA TN D-8029.
- Townsend, D. P., 1982, "Effect of Shot Peening on Surface Fatigue Life of Carburized and Hardened AISI 9310 Spur Gears," NASA TP-2047.
- Townsend, D. P., Turza, A., and Chaplin, M., 1995, "The Surface Fatigue Life of Contour Induction Hardened AISI 1552 Gears," NASA TM-107017.
- Townsend, D. P., and Zaretsky, E. V., 1980, "Comparisons of Modified Vasco X-2 and AISI 9310 Gear Steels," NASA TP-1731.
- Townsend, D. P., 1992, "Improvements in Surface Fatigue Life of Hardened Gears by High-Intensity Shot Peening," NASA TM-105678.
- Townsend, D. P., and Bamberger, E. N., 1989, "Surface Fatigue Life of Carburized and Hardened M50NiL and AISI 9310 Spur Gears and Rolling-Contact Test Bars," NASA TM-101979.