

# UC Santa Cruz

## UC Santa Cruz Previously Published Works

### Title

System and Method for Efficient Name-Based Content Routing Using Link-State Information in Information-Centric Networks

### Permalink

<https://escholarship.org/uc/item/9qg9q3cj>

### Author

Garcia-Luna-Aceves, J.J.

### Publication Date

2018-06-19

Peer reviewed

(12) **United States Patent**  
**Garcia-Luna-Aceves**

(10) **Patent No.:** **US 10,003,520 B2**  
(45) **Date of Patent:** **Jun. 19, 2018**

- |   |   |
|---|---|
| (54) <b>SYSTEM AND METHOD FOR EFFICIENT NAME-BASED CONTENT ROUTING USING LINK-STATE INFORMATION IN INFORMATION-CENTRIC NETWORKS</b> | 4,921,898 A 5/1990 Lenney<br>5,070,134 A 12/1991 Oyamada<br>5,110,856 A 5/1992 Oyamada<br>5,214,702 A 5/1993 Fischer<br>5,265,092 A * 11/1993 Soloway ..... H04L 45/18<br>370/238 |
| (71) Applicant: <b>CISCO TECHNOLOGY, INC.</b> , San Jose, CA (US)   | 5,377,354 A 12/1994 Scannell<br>(Continued)   |

(72) Inventor: **Jose J. Garcia-Luna-Aceves**, San Mateo, CA (US)

FOREIGN PATENT DOCUMENTS

(73) Assignee: **Cisco Technology, Inc.**, San Jose, CA (US)

CN	103873371	6/2014
DE	1720277 A1	6/1967

(Continued)

(\* ) Notice: Subject to any disclaimer, the term of this patent is extended or adjusted under 35 U.S.C. 154(b) by 492 days.

OTHER PUBLICATIONS

(21) Appl. No.: **14/579,925**

Hiryanto et al., (Efficient Prefix Updates for IP Router Using Lexicographic Ordering and Updateable Address Set, Jan. 2008, IEEE Computer Society, vol. 57, No. 1, pp. 110-125).\*

(22) Filed: **Dec. 22, 2014**

(Continued)

(65) **Prior Publication Data**  
US 2016/0182353 A1 Jun. 23, 2016

*Primary Examiner* — Vivek Srivastava  
*Assistant Examiner* — Muhammad Raza

(51) **Int. Cl.**  
**H04L 12/721** (2013.01)  
**H04L 12/725** (2013.01)

(52) **U.S. Cl.**  
CPC ..... **H04L 45/12** (2013.01); **H04L 45/306** (2013.01); **H04L 45/38** (2013.01)

(57) **ABSTRACT**

(58) **Field of Classification Search**  
CPC ... H04L 45/12; H04L 45/306; H04L 12/6418; H04L 45/20; H04L 67/327; H04N 21/64746; H04N 21/84  
See application file for complete search history.

One embodiment of the present invention provides a system for updating link-status information associated with a prefix in an information-centric network (ICN). During operation, a first node in the ICN receives a link-state advertisement (LSA) message from a neighbor node with the LSA message specifying a prefix and an anchor node advertising the specified prefix. The system determines, based on topology information stored on the first node, whether a shortest-path condition is met, and forwards the received LSA message to other neighbors of the first node in response to the shortest-path condition being met.

(56) **References Cited**  
U.S. PATENT DOCUMENTS

817,441 A	4/1906	Niesz
4,309,569 A	1/1982	Merkle

**20 Claims, 7 Drawing Sheets**

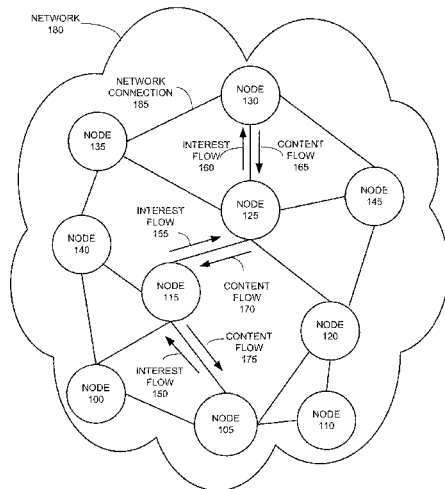

(56)

References Cited

U.S. PATENT DOCUMENTS

5,506,844	A	4/1996	Rao	7,636,767	B2	12/2009	Lev-Ran
5,629,370	A	5/1997	Freidzon	7,647,507	B1	1/2010	Feng
5,845,207	A	12/1998	Amin	7,660,324	B2	2/2010	Oguchi
5,870,605	A	2/1999	Bracho	7,685,290	B2	3/2010	Satapati
6,047,331	A	4/2000	Medard	7,698,463	B2	4/2010	Ogier
6,052,683	A	4/2000	Irwin	7,698,559	B1	4/2010	Chaudhury
6,085,320	A	7/2000	Kaliski, Jr.	7,769,887	B1	8/2010	Bhattacharyya
6,091,724	A	7/2000	Chandra	7,779,467	B2	8/2010	Choi
6,128,623	A	10/2000	Mattis	7,801,069	B2	9/2010	Cheung
6,128,627	A	10/2000	Mattis	7,801,177	B2	9/2010	Luss
6,173,364	B1	1/2001	Zenchelsky	7,816,441	B2	10/2010	Elizalde
6,209,003	B1	3/2001	Mattis	7,831,733	B2	11/2010	Sultan
6,226,618	B1	5/2001	Downs	7,873,619	B1	1/2011	Faibish
6,233,617	B1	5/2001	Rothwein	7,908,337	B2	3/2011	Garcia-Luna-Aceves
6,233,646	B1	5/2001	Hahm	7,924,837	B1	4/2011	Shabtay
6,289,358	B1	9/2001	Mattis	7,953,014	B2	5/2011	Toda
6,292,880	B1	9/2001	Mattis	7,953,885	B1	5/2011	Devireddy
6,332,158	B1	12/2001	Risley	7,979,912	B1	7/2011	Roka
6,363,067	B1	3/2002	Chung	8,000,267	B2	8/2011	Solis
6,366,988	B1	4/2002	Skiba	8,010,691	B2	8/2011	Kollmansberger
6,574,377	B1	6/2003	Cahill	8,069,023	B1	11/2011	Frailong
6,654,792	B1	11/2003	Verma	8,074,289	B1	12/2011	Carpentier
6,667,957	B1	12/2003	Corson	8,117,441	B2	2/2012	Kurien
6,681,220	B1	1/2004	Kaplan	8,160,069	B2	4/2012	Jacobson
6,681,326	B2	1/2004	Son	8,204,060	B2	6/2012	Jacobson
6,732,273	B1	5/2004	Byers	8,214,364	B2	7/2012	Bigus
6,769,066	B1	7/2004	Botros	8,224,985	B2	7/2012	Takeda
6,772,333	B1	8/2004	Brendel	8,225,057	B1	7/2012	Zheng
6,775,258	B1	8/2004	vanValkenburg	8,271,578	B2	9/2012	Sheffi
6,862,280	B1	3/2005	Bertagna	8,271,687	B2	9/2012	Turner
6,901,452	B1	5/2005	Bertagna	8,312,064	B1	11/2012	Gauvin
6,915,307	B1	7/2005	Mattis	8,332,357	B1	12/2012	Chung
6,917,985	B2	7/2005	Madruaga	8,386,622	B2	2/2013	Jacobson
6,957,228	B1	10/2005	Graser	8,447,851	B1	5/2013	Anderson
6,968,393	B1	11/2005	Chen	8,462,781	B2	6/2013	McGhee
6,981,029	B1	12/2005	Menditto	8,467,297	B2	6/2013	Liu
7,007,024	B2	2/2006	Zelenka	8,473,633	B2	6/2013	Eardley
7,013,389	B1	3/2006	Srivastava	8,553,562	B2	10/2013	Allan
7,031,308	B2	4/2006	Garcia-Luna-Aceves	8,572,214	B2*	10/2013	Garcia-Luna-Aceves
7,043,637	B2	5/2006	Bolosky				..... G06F 12/1483
7,061,877	B1	6/2006	Gummalla	8,654,649	B2	2/2014	Vasseur
7,080,073	B1	7/2006	Jiang	8,665,757	B2	3/2014	Kling
RE39,360	E	10/2006	Aziz	8,667,172	B2	3/2014	Ravindran
7,149,750	B2	12/2006	Chadwick	8,677,451	B1	3/2014	Bhimaraju
7,152,094	B1	12/2006	Jannu	8,688,619	B1	4/2014	Ezick
7,177,646	B2	2/2007	ONeill	8,699,350	B1	4/2014	Kumar
7,206,860	B2	4/2007	Murakami	8,718,055	B2	5/2014	Vasseur
7,206,861	B1	4/2007	Callon	8,750,820	B2	6/2014	Allan
7,210,326	B2	5/2007	Kawamoto	8,761,022	B2	6/2014	Chiabaut
7,246,159	B2	7/2007	Aggarwal	8,762,477	B2	6/2014	Xie
7,257,837	B2	8/2007	Xu	8,762,570	B2	6/2014	Qian
7,287,275	B2	10/2007	Moskowitz	8,762,707	B2	6/2014	Killian
7,315,541	B1	1/2008	Housel	8,767,627	B2	7/2014	Ezure
7,339,929	B2	3/2008	Zelig	8,817,594	B2	8/2014	Gero
7,350,229	B1	3/2008	Lander	8,826,381	B2	9/2014	Kim
7,362,727	B1	4/2008	ONeill	8,832,302	B1	9/2014	Bradford
7,382,787	B1	6/2008	Barnes	8,836,536	B2	9/2014	Marwah
7,395,507	B2	7/2008	Robarts	8,861,356	B2	10/2014	Kozat
7,430,755	B1	9/2008	Hughes	8,862,774	B2	10/2014	Vasseur
7,444,251	B2	10/2008	Nikovski	8,863,227	B2*	10/2014	Zhang
7,466,703	B1	12/2008	Arunachalam				..... G06F 21/10
7,472,422	B1	12/2008	Agbabian	8,868,779	B2	10/2014	ONeill
7,496,668	B2	2/2009	Hawkinson	8,874,842	B1	10/2014	Kimmel
7,509,425	B1	3/2009	Rosenberg	8,880,682	B2	11/2014	Bishop
7,523,016	B1	4/2009	Surdulescu	8,903,756	B2	12/2014	Zhao
7,542,471	B2	6/2009	Samuels	8,923,293	B2	12/2014	Jacobson
7,543,064	B2	6/2009	Juncker	8,934,496	B2	1/2015	Vasseur
7,552,233	B2	6/2009	Raju	8,937,865	B1	1/2015	Kumar
7,555,482	B2	6/2009	Korkus	8,972,969	B2	3/2015	Gaither
7,555,563	B2	6/2009	Ott	8,977,596	B2	3/2015	Montulli
7,564,812	B1	7/2009	Elliott	9,002,921	B2	4/2015	Westphal
7,567,547	B2	7/2009	Mosko	9,032,095	B1	5/2015	Traina
7,567,946	B2	7/2009	Andreoli	9,071,498	B2	6/2015	Beser
7,580,971	B1	8/2009	Gollapudi	9,112,895	B1	8/2015	Lin
7,623,535	B2	11/2009	Guichard	9,137,152	B2	9/2015	Xie
				9,253,087	B2	2/2016	Zhang
				9,270,598	B1	2/2016	Oran
				9,280,610	B2	3/2016	Gruber

(56)	<b>References Cited</b>			2006/0133343 A1	6/2006	Huang	
	U.S. PATENT DOCUMENTS			2006/0140136 A1*	6/2006	Filsfils .....	H04L 45/02 370/255
	9,326,042 B2*	4/2016	Hong .....	2006/0146686 A1	7/2006	Kim	
	2002/0002680 A1	1/2002	Carbajal	2006/0173831 A1	8/2006	Basso	
	2002/0010795 A1	1/2002	Brown	2006/0193295 A1	8/2006	White	
	2002/0038296 A1	3/2002	Margolus	2006/0203804 A1	9/2006	Whitmore	
	2002/0048269 A1	4/2002	Hong	2006/0206445 A1	9/2006	Andreoli	
	2002/0054593 A1	5/2002	Morohashi	2006/0215684 A1	9/2006	Capone	
	2002/0077988 A1	6/2002	Sasaki	2006/0223504 A1	10/2006	Ishak	
	2002/0078066 A1	6/2002	Robinson	2006/0242155 A1	10/2006	Moore	
	2002/0101869 A1*	8/2002	Garcia-Luna- Aceves .....	2006/0245374 A1*	11/2006	Patel .....	H04L 45/04 370/254
			H04L 45/025 370/389	2006/0256767 A1	11/2006	Suzuki	
	2002/0138551 A1	9/2002	Erickson	2006/0268792 A1	11/2006	Belcea	
	2002/0152305 A1	10/2002	Jackson	2007/0019619 A1	1/2007	Foster	
	2002/0176404 A1	11/2002	Girard	2007/0073888 A1	3/2007	Madhok	
	2002/0188605 A1	12/2002	Adya	2007/0094265 A1	4/2007	Korkus	
	2002/0199014 A1	12/2002	Yang	2007/0112880 A1	5/2007	Yang	
	2003/0004621 A1	1/2003	Bousquet	2007/0124412 A1	5/2007	Narayanawami	
	2003/0009365 A1	1/2003	Tynan	2007/0127457 A1	6/2007	Mirtorabi	
	2003/0026268 A1*	2/2003	Navas .....	2007/0160062 A1	7/2007	Morishita	
			H04L 29/12009 370/400	2007/0162394 A1	7/2007	Zager	
	2003/0033394 A1*	2/2003	Stine .....	2007/0171828 A1	7/2007	Dalal	
			H04L 12/5695 709/222	2007/0189284 A1	8/2007	Kecskemeti	
	2003/0046396 A1	3/2003	Richter	2007/0195765 A1	8/2007	Heissenbuttel	
	2003/0046421 A1	3/2003	Horvitz et al.	2007/0204011 A1	8/2007	Shaver	
	2003/0046437 A1	3/2003	Eytchison	2007/0209067 A1	9/2007	Fogel	
	2003/0048793 A1	3/2003	Pochon	2007/0214275 A1*	9/2007	Mirtorabi .....	H04L 45/02 709/230
	2003/0051100 A1	3/2003	Patel	2007/0239892 A1	10/2007	Ott	
	2003/0061384 A1	3/2003	Nakatani	2007/0240207 A1	10/2007	Belakhdar	
	2003/0074472 A1	4/2003	Lucco	2007/0245034 A1	10/2007	Retana	
	2003/0088696 A1	5/2003	McCanne	2007/0253418 A1	11/2007	Shiri	
	2003/0097447 A1	5/2003	Johnston	2007/0255677 A1	11/2007	Alexander	
	2003/0099237 A1	5/2003	Mitra	2007/0255699 A1	11/2007	Sreenivas	
	2003/0117966 A1*	6/2003	Chen .....	2007/0255781 A1	11/2007	Li	
			H04L 45/02 370/255	2007/0274504 A1	11/2007	Maes	
	2003/0140257 A1	7/2003	Paterka	2007/0275701 A1	11/2007	Jonker	
	2003/0229892 A1	12/2003	Sardera	2007/0276907 A1	11/2007	Maes	
	2004/0024879 A1	2/2004	Dingman	2007/0283158 A1	12/2007	Danseglio	
	2004/0030602 A1	2/2004	Rosenquist	2007/0294187 A1	12/2007	Scherrer	
	2004/0064737 A1	4/2004	Milliken	2008/0005056 A1	1/2008	Stelzig	
	2004/0071140 A1	4/2004	Jason	2008/0005223 A1	1/2008	Flake	
	2004/0073617 A1	4/2004	Milliken	2008/0010366 A1	1/2008	Duggan	
	2004/0073715 A1	4/2004	Folkes	2008/0037420 A1	2/2008	Tang	
	2004/0139230 A1	7/2004	Kim	2008/0043989 A1	2/2008	Furutono	
	2004/0196783 A1	10/2004	Shinomiya	2008/0046340 A1	2/2008	Brown	
	2004/0218548 A1	11/2004	Kennedy	2008/0059631 A1	3/2008	Bergstrom	
	2004/0221047 A1	11/2004	Grover	2008/0080440 A1	4/2008	Yarvis	
	2004/0225627 A1	11/2004	Botros	2008/0082662 A1	4/2008	Dandliker	
	2004/0233916 A1	11/2004	Takeuchi	2008/0095159 A1	4/2008	Suzuki	
	2004/0246902 A1	12/2004	Weinstein	2008/0101357 A1	5/2008	Iovanna	
	2004/0252683 A1	12/2004	Kennedy	2008/0107034 A1	5/2008	Jetcheva	
	2005/0003832 A1	1/2005	Osafune	2008/0107259 A1	5/2008	Satou	
	2005/0021622 A1*	1/2005	Cullen .....	2008/0123862 A1	5/2008	Rowley	
			G06Q 30/02 709/204	2008/0133583 A1	6/2008	Artan	
	2005/0028156 A1	2/2005	Hammond	2008/0133755 A1	6/2008	Pollack	
	2005/0043060 A1	2/2005	Brandenberg	2008/0151755 A1	6/2008	Nishioka	
	2005/0050211 A1	3/2005	Kaul	2008/0159271 A1	7/2008	Kutt	
	2005/0074001 A1	4/2005	Mattes	2008/0165775 A1	7/2008	Das	
	2005/0132207 A1	6/2005	Mourad	2008/0170518 A1*	7/2008	Duggi .....	H04L 45/18 370/310
	2005/0149508 A1	7/2005	Deshpande	2008/0186901 A1	8/2008	Itagaki	
	2005/0159823 A1	7/2005	Hayes	2008/0200153 A1	8/2008	Fitzpatrick	
	2005/0198351 A1	9/2005	Nog	2008/0215669 A1	9/2008	Gaddy	
	2005/0249196 A1	11/2005	Ansari	2008/0216086 A1	9/2008	Tanaka	
	2005/0259637 A1	11/2005	Chu	2008/0243992 A1	10/2008	Jardetzky	
	2005/0262217 A1	11/2005	Nonaka	2008/0250006 A1	10/2008	Dettinger	
	2005/0281288 A1	12/2005	Banerjee	2008/0256138 A1	10/2008	Sim-Tang	
	2005/0286535 A1	12/2005	Shrum	2008/0256359 A1	10/2008	Kahn	
	2005/0289222 A1	12/2005	Sahim	2008/0270618 A1	10/2008	Rosenberg	
	2006/0010249 A1	1/2006	Sabesan	2008/0271143 A1	10/2008	Stephens	
	2006/0029102 A1	2/2006	Abe	2008/0287142 A1	11/2008	Keighran	
	2006/0039379 A1	2/2006	Abe	2008/0288580 A1	11/2008	Wang	
	2006/0051055 A1	3/2006	Ohkawa	2008/0291923 A1	11/2008	Back	
	2006/0072523 A1	4/2006	Richardson	2008/0298376 A1	12/2008	Takeda	
	2006/0099973 A1	5/2006	Nair	2008/0320148 A1	12/2008	Capuozzo	
	2006/0129514 A1	6/2006	Watanabe	2009/0006659 A1	1/2009	Collins	

(56)

References Cited

U.S. PATENT DOCUMENTS

2009/0013324	A1	1/2009	Gobara	2010/0250939	A1	9/2010	Adams
2009/0022154	A1	1/2009	Kiribe	2010/0257149	A1	10/2010	Cognigni
2009/0024641	A1	1/2009	Quigley	2010/0268782	A1	10/2010	Zombek
2009/0030978	A1	1/2009	Johnson	2010/0272107	A1	10/2010	Papp
2009/0037763	A1	2/2009	Adhya	2010/0281263	A1	11/2010	Ugawa
2009/0052660	A1	2/2009	Chen	2010/0284309	A1	11/2010	Allan
2009/0067429	A1	3/2009	Nagai	2010/0284404	A1	11/2010	Gopinath
2009/0077184	A1	3/2009	Brewer	2010/0293293	A1	11/2010	Beser
2009/0092043	A1	4/2009	Lapuh	2010/0322249	A1	12/2010	Thathapudi
2009/0097631	A1	4/2009	Gisby	2011/0013637	A1	1/2011	Xue
2009/0103515	A1	4/2009	Pointer	2011/0019674	A1	1/2011	Iovanna
2009/0113068	A1	4/2009	Fujihira	2011/0022812	A1	1/2011	Vanderlinden
2009/0116393	A1	5/2009	Hughes	2011/0029952	A1	2/2011	Harrington
2009/0117922	A1	5/2009	Bell	2011/0055392	A1	3/2011	Shen
2009/0132662	A1	5/2009	Sheridan	2011/0055921	A1	3/2011	Narayanaswamy
2009/0135728	A1	5/2009	Shen	2011/0060716	A1	3/2011	Forman
2009/0144300	A1	6/2009	Chatley	2011/0060717	A1	3/2011	Forman
2009/0157887	A1	6/2009	Froment	2011/0090908	A1	4/2011	Jacobson
2009/0161578	A1*	6/2009	Yeung	2011/0106755	A1	5/2011	Hao
				2011/0131308	A1	6/2011	Eriksson
				2011/0137919	A1	6/2011	Ryu
				2011/0145597	A1	6/2011	Yamaguchi
				2011/0145858	A1	6/2011	Philpott
				2011/0149858	A1	6/2011	Hwang
				2011/0153840	A1	6/2011	Narayana
2009/0185745	A1	7/2009	Momosaki	2011/0158122	A1	6/2011	Murphy
2009/0193101	A1	7/2009	Munetsugu	2011/0161408	A1	6/2011	Kim
2009/0198832	A1	8/2009	Shah	2011/0202609	A1	8/2011	Chaturvedi
2009/0222344	A1	9/2009	Greene	2011/0219093	A1	9/2011	Ragunathan
2009/0228593	A1	9/2009	Takeda	2011/0219427	A1	9/2011	Hito
2009/0254572	A1	10/2009	Redlich	2011/0219727	A1	9/2011	May
2009/0268905	A1	10/2009	Matsushima	2011/0225293	A1	9/2011	Rathod
2009/0274158	A1	11/2009	Sharp	2011/0231578	A1	9/2011	Nagappan
2009/0276396	A1	11/2009	Gorman	2011/0239256	A1	9/2011	Gholmieh
2009/0285209	A1	11/2009	Stewart	2011/0258049	A1	10/2011	Ramer
2009/0287835	A1*	11/2009	Jacobson	2011/0264824	A1	10/2011	Venkata Subramanian
				2011/0265159	A1	10/2011	Ronda
				2011/0265174	A1	10/2011	Thornton
2009/0287853	A1	11/2009	Carson	2011/0271007	A1	11/2011	Wang
2009/0288076	A1	11/2009	Johnson	2011/0280214	A1	11/2011	Lee
2009/0288143	A1	11/2009	Stebila	2011/0286457	A1	11/2011	Ee
2009/0288163	A1	11/2009	Jacobson	2011/0286459	A1	11/2011	Rembarz
2009/0292743	A1	11/2009	Bigus	2011/0295783	A1	12/2011	Zhao
2009/0293121	A1	11/2009	Bigus	2011/0299454	A1	12/2011	Krishnaswamy
2009/0296719	A1	12/2009	Maier	2012/0011170	A1	1/2012	Elad
2009/0300079	A1	12/2009	Shitomi	2012/0011551	A1	1/2012	Levy
2009/0300407	A1	12/2009	Kamath	2012/0023113	A1	1/2012	Ferren
2009/0300512	A1	12/2009	Ahn	2012/0036180	A1	2/2012	Thornton
2009/0307333	A1	12/2009	Welingkar	2012/0039164	A1*	2/2012	Enyedi
2009/0323632	A1	12/2009	Nix				
2010/0005061	A1	1/2010	Basco	2012/0045064	A1	2/2012	Rembarz
2010/0027539	A1	2/2010	Beverly	2012/0047361	A1	2/2012	Erdmann
2010/0046546	A1	2/2010	Ram	2012/0051212	A1*	3/2012	Xu
2010/0057929	A1	3/2010	Merat				
2010/0058346	A1	3/2010	Narang	2012/0066727	A1	3/2012	Nozoe
2010/0088370	A1	4/2010	Wu	2012/0106339	A1	5/2012	Mishra
2010/0094767	A1	4/2010	Miltonberger	2012/0110159	A1	5/2012	Richardson
2010/0094876	A1	4/2010	Huang	2012/0114313	A1	5/2012	Phillips
2010/0098093	A1	4/2010	Ejzak	2012/0120803	A1	5/2012	Farkas
2010/0100465	A1	4/2010	Cooke	2012/0127994	A1	5/2012	Ko
2010/0103870	A1	4/2010	Garcia-Luna-Aceves	2012/0136676	A1	5/2012	Goodall
2010/0124191	A1	5/2010	Vos	2012/0136936	A1	5/2012	Quintana
2010/0125911	A1	5/2010	Bhaskaran	2012/0136945	A1	5/2012	Lee
2010/0131660	A1	5/2010	Dec	2012/0137367	A1	5/2012	Dupont
2010/0150155	A1	6/2010	Napierala	2012/0141093	A1	6/2012	Yamaguchi
2010/0165976	A1	7/2010	Khan	2012/0155464	A1	6/2012	Kim
2010/0169478	A1	7/2010	Saha	2012/0158973	A1	6/2012	Jacobson
2010/0169503	A1	7/2010	Kollmansberger	2012/0163373	A1	6/2012	Lo
2010/0180332	A1	7/2010	Ben-Yochanan	2012/0166433	A1	6/2012	Tseng
2010/0182995	A1	7/2010	Hwang	2012/0170913	A1	7/2012	Isozaki
2010/0185753	A1	7/2010	Liu	2012/0179653	A1	7/2012	Araki
2010/0195653	A1	8/2010	Jacobson	2012/0197690	A1	8/2012	Agulnek
2010/0195654	A1	8/2010	Jacobson	2012/0198048	A1	8/2012	Ioffe
2010/0195655	A1	8/2010	Jacobson	2012/0207159	A1*	8/2012	Buchko
2010/0217874	A1	8/2010	Anantharaman				
2010/0217985	A1	8/2010	Fahrny	2012/0221150	A1	8/2012	Arensmeier
2010/0232402	A1	9/2010	Przybysz	2012/0224487	A1	9/2012	Hui
2010/0232439	A1	9/2010	Dham	2012/0226902	A1	9/2012	Kim
2010/0235516	A1	9/2010	Nakamura				
2010/0246549	A1	9/2010	Zhang				
2010/0250497	A1	9/2010	Redlich				

H04L 45/02  
370/254

H04L 67/104  
709/229

H04L 45/00  
370/217

H04L 41/0659  
370/223

H04L 45/16  
370/390



(56)

## References Cited

## U.S. PATENT DOCUMENTS

2015/0109934	A1*	4/2015	Harshavardha .....	H04L 45/125 370/238
2015/0120663	A1	4/2015	LeScouarnec	
2015/0169758	A1	6/2015	Assom	
2015/0188770	A1	7/2015	Naiksatam	
2015/0195149	A1	7/2015	Vasseur	
2015/0207633	A1	7/2015	Ravindran	
2015/0207864	A1	7/2015	Wilson	
2015/0236752	A1*	8/2015	Cruz .....	H04K 1/003 375/135
2015/0279348	A1	10/2015	Cao	
2015/0288755	A1	10/2015	Mosko	
2015/0312300	A1	10/2015	Mosko	
2015/0349961	A1	12/2015	Mosko	
2015/0350062	A1*	12/2015	Lindem, III .....	H04L 45/22 370/220
2015/0372903	A1	12/2015	Hui	
2015/0381546	A1	12/2015	Mahadevan	
2016/0019275	A1	1/2016	Mosko	
2016/0021172	A1	1/2016	Mahadevan	
2016/0062840	A1	3/2016	Scott	
2016/0087887	A1*	3/2016	Fung .....	H04L 49/3009 370/401
2016/0110466	A1	4/2016	Uzun	
2016/0171184	A1	6/2016	Solis	
2016/0255001	A1*	9/2016	Wang .....	H04L 12/6418 370/392

## FOREIGN PATENT DOCUMENTS

DE	19620817	A1	11/1997
EP	0295727	A2	12/1988
EP	0757065	A2	7/1996
EP	1077422	A2	2/2001
EP	1383265	A1	1/2004
EP	1384729	A1	1/2004
EP	1473889	A2	11/2004
EP	2120402		11/2009
EP	2120419		11/2009
EP	2120419	A2	11/2009
EP	2124415	A2	11/2009
EP	2214357	A1	8/2010
EP	2299754	A1	3/2011
EP	2323346		5/2011
EP	2552083		1/2013
EP	2214356		5/2016
WO	03005288	A2	1/2003
WO	03042254	A1	5/2003
WO	03049369	A2	6/2003
WO	03091297	A1	11/2003
WO	2007113180	A1	10/2007
WO	2007122620		11/2007
WO	2007144388	A1	12/2007
WO	2011049890	A1	4/2011
WO	2012077073	A1	6/2012
WO	2013123410		8/2013
WO	2015084327		6/2015

## OTHER PUBLICATIONS

Jacobson, Van et al., "Content-Centric Networking, Whitepaper Describing Future Assurable Global Networks", Palo Alto Research Center, Inc., Jan. 30, 2007, pp. 1-9.

Koponen, Teemu et al., "A Data-Oriented (and Beyond) Network Architecture", SIGCOMM '07, Aug. 27-31, 2007, Kyoto, Japan, XP-002579021, p. 181-192.

Fall, K. et al., "DTN: an architectural retrospective", Selected areas in communications, IEEE Journal on, vol. 28, No. 5, Jun. 1, 2008, pp. 828-835.

Gritter, M. et al., "An Architecture for content routing support in the Internet", Proceedings of 3rd Usenix Symposium on Internet Technologies and Systems, 2001, pp. 37-48.

"CCNx," <http://ccnx.org/>. downloaded Mar. 11, 2015.

"Content Delivery Network", Wikipedia, Dec. 10, 2011, [http://en.wikipedia.org/w/index.php?title=Content\\_delivery\\_network&oldid=465077460](http://en.wikipedia.org/w/index.php?title=Content_delivery_network&oldid=465077460).

"Digital Signature" archived on Aug. 31, 2009 at [http://web.archive.org/web/20090831170721/http://en.wikipedia.org/wiki/Digital\\_signature](http://web.archive.org/web/20090831170721/http://en.wikipedia.org/wiki/Digital_signature).

"Introducing JSON," <http://www.json.org/>. downloaded Mar. 11, 2015.

"Microsoft PlayReady," <http://www.microsoft.com/playready/>. downloaded Mar. 11, 2015.

"The FP7 4WARD project," <http://www.4ward-project.eu/>. downloaded Mar. 11, 2015.

A. Broder and A. Karlin, "Multilevel Adaptive Hashing", Jan. 1990, pp. 43-53.

A. Wolman, M. Voelker, N. Sharma N. Cardwell, Aa. Karlin, and H.M. Levy, "On the scale and performance of cooperative web proxy caching," ACM SIGHOPS Operating Systems Review, vol. 33, No. 5, pp. 16-31, Dec. 1999.

Afanasyev, Alexander, et al. "Interest flooding attack and countermeasures in Named Data Networking." IFIP Networking Conference, 2013. IEEE, 2013.

Ao-Jan Su, David R. Choffnes, Aleksandar Kuzmanovic, and Fabian E. Bustamante. Drafting Behind Akamai: Inferring Network Conditions Based on CDN Redirections. IEEE/ACM Transactions on Networking {Feb. 2009}.

Bari, MdFaizul, et al. 'A survey of naming and routing in information-centric networks.' Communications Magazine, IEEE 50.12 (2012): 44-53.

Baughner, Mark et al., "Self-Verifying Names for Read-Only Named Data", 2012 IEEE Conference on Computer Communications Workshops (INFOCOM WKSHOPS), Mar. 2012, pp. 274-279.

Brambley, Michael, A novel, low-cost, reduced-sensor approach for providing smart remote monitoring and diagnostics for packaged air conditioners and heat pumps. Pacific Northwest National Laboratory, 2009.

C. Gentry and A. Silverberg. Hierarchical ID-Based Cryptography. Advances in Cryptology—ASIACRYPT 2002. Springer Berlin Heidelberg (2002).

C.A. Wood and E. Uzun, "Flexible end-to-end content security in CCN," in Proc. IEEE CCNC 2014, Las Vegas, CA, USA, Jan. 2014.

Carzaniga, Antonio, Matthew J. Rutherford, and Alexander L. Wolf. 'A routing scheme for content-based networking.' INFOCOM 2004. Twenty-third Annual Joint Conference of the IEEE Computer and Communications Societies. vol. 2. IEEE, 2004.

Cho, Jin-Hee, Ananthram Swami, and Ray Chen. "A survey on trust management for mobile ad hoc networks." Communications Surveys & Tutorials, IEEE 13.4 (2011): 562-583.

Compagno, Alberto, et al. "Poseidon: Mitigating interest flooding DDoS attacks in named data networking." Local Computer Networks (LCN), 2013 IEEE 38th Conference on. IEEE, 2013.

Conner, William, et al. "A trust management framework for service-oriented environments." Proceedings of the 18th international conference on World wide web. ACM, 2009.

D. Boneh and M. Franklin. Identity-Based Encryption from the Weil Pairing. Advances in Cryptology—CRYPTO 2001, vol. 2139, Springer Berlin Heidelberg (2001).

D.K. Smetters, P. Golle, and J.D. Thornton, "CCNx access control specifications," PARC, Tech. Rep., Jul. 2010.

Dabirmoghaddam, Ali, Maziar Mirzazad Barijough, and J. J. Garcia-Luna-Aceves. 'Understanding optimal caching and opportunistic caching at the edge of information-centric networks.' Proceedings of the 1st international conference on Information-centric networking. ACM, 2014.

Deti et al., "Supporting the Web with an information centric network that routes by name", Aug. 2012, Computer Networks 56, pp. 3705-3702.

Dijkstra, Edsger W., and Carel S. Scholten. 'Termination detection for diffusing computations.' Information Processing Letters 11.1 (1980): 1-4.

Dijkstra, Edsger W., Wim HJ Feijen, and A\_J M. Van Gasteren. "Derivation of a termination detection algorithm for distributed

(56)

## References Cited

## OTHER PUBLICATIONS

- computations." Control Flow and Data Flow: concepts of distributed programming. Springer Berlin Heidelberg, 1986. 507-512.
- E. Rescorla and N. Modadugu, "Datagram transport layer security," IETF RFC 4347, Apr. 2006.
- E.W. Dijkstra, W. Feijen, and A.J.M. Van Gasteren, "Derivation of a Termination Detection Algorithm for Distributed Computations," Information Processing Letter, vol. 16, No. 5, 1983.
- Fayazbakhsh, S. K., Lin, Y., Tootoonchian, A., Ghodsi, A., Koponen, T., Maggs, B., & Shenker, S. {Aug. 2013}. Less pain, most of the gain: Incrementally deployable ICN. In ACM SIGCOMM Computer Communication Review (vol. 43, No. 4, pp. 147-158). ACM.
- G. Tyson, S. Kaune, S. Miles, Y. El-Khatib, A. Mauthe, and A. Taweel, "A trace-driven analysis of caching in content-centric networks," in Proc. IEEE ICCCN 2012, Munich, Germany, Jul.-Aug. 2012, pp. 1-7.
- G. Wang, Q. Liu, and J. Wu, "Hierarchical attribute-based encryption for fine-grained access control in cloud storage services," in Proc. ACM CCS 2010, Chicago, IL, USA, Oct. 2010, pp. 735-737.
- G. Xylomenos et al., "A Survey of Information-centric Networking Research," IEEE Communication Surveys and Tutorials, Jul. 2013.
- Garcia, Humberto E., Wen-Chiao Lin, and Semyon M. Meerkov. "A resilient condition assessment monitoring system." Resilient Control Systems (ISRCs), 2012 5th International Symposium on. IEEE, 2012.
- Garcia-Luna-Aceves, Jose J. 'A unified approach to loop-free routing using distance vectors or link states.' ACM SIGCOMM Computer Communication Review. vol. 19. No. 4. ACM, 1989.
- Garcia-Luna-Aceves, Jose J. 'Name-Based Content Routing in Information Centric Networks Using Distance Information' Proc ACM ICN 2014, Sep. 2014.
- Ghali, Cesar, GeneTsudik, and Ersin Uzun. "Needle in a Haystack: Mitigating Content Poisoning in Named-Data Networking." Proceedings of NDSS Workshop on Security of Emerging Networking Technologies (SENT). 2014.
- Ghodsi, Ali, et al. "Information-centric networking: seeing the forest for the trees." Proceedings of the 10th ACM Workshop on Hot Topics in Networks. ACM, 2011.
- Ghodsi, Ali, et al. "Naming in content-oriented architectures." Proceedings of the ACM SIGCOMM workshop on Information-centric networking. ACM, 2011.
- Heckerman, David, John S. Breese, and Koos Rommelse. "Decision-Theoretic Troubleshooting." Communications of the ACM. 1995.
- Heinemeier, Kristin, et al. "Uncertainties in Achieving Energy Savings from HVAC Maintenance Measures in the Field." ASHRAE Transactions 118.Part 2 (2012).
- Herlich, Matthias et al., "Optimizing Energy Efficiency for Bulk Transfer Networks", Apr. 13, 2010, pp. 1-3, retrieved for the Internet: [URL:http://www.cs.uni-paderborn.de/fileadmin/informationik/ag-karl/publications/miscellaneous/optimizing.pdf](http://www.cs.uni-paderborn.de/fileadmin/informationik/ag-karl/publications/miscellaneous/optimizing.pdf) (retrieved on Mar. 9, 2012). <https://code.google.com/p/cenx-trace/>.
- I. Psaras, R.G. Clegg, R. Landa, W.K. Chai, and G. Pavlou, "Modelling and evaluation of CCN-caching trees," in Proc. IFIP Networking 2011, Valencia, Spain, May 2011, pp. 78-91.
- Intanagonwivat, Chalermek, Ramesh Govindan, and Deborah Estrin. "Directed diffusion: a scalable and robust communication paradigm for sensor networks." Proceedings of the 6th annual international conference on Mobile computing and networking. ACM, 2000.
- J. Aumasson and D. Bernstein, "SipHash: a fast short-input PRF", Sep. 18, 2012.
- J. Bethencourt, A. Sahai, and B. Waters, "Ciphertext-policy attribute-based encryption," in Proc. IEEE Security & Privacy 2007, Berkeley, CA, USA, May 2007, pp. 321-334.
- J. Hur, "Improving security and efficiency in attribute-based data sharing," IEEE Trans. Knowledge Data Eng., vol. 25, No. 10, pp. 2271-2282, Oct. 2013.
- J. Shao and Z. Cao. CCA-Secure Proxy Re-Encryption without Pairings. Public Key Cryptography. Springer Lecture Notes in Computer Science vol. 5443 (2009).
- Jacobson, Van et al. 'VoCCN: Voice Over Content-Centric Networks.' Dec. 1, 2009. ACM ReArch'09.
- Jacobson et al., "Custodian-Based Information Sharing," Jul. 2012, IEEE Communications Magazine: vol. 50 Issue 7 (p. 3843).
- Ji, Kun, et al. "Prognostics enabled resilient control for model-based building automation systems." Proceedings of the 12th Conference of International Building Performance Simulation Association. 2011.
- K. Liang, L. Fang, W. Susilo, and D.S. Wong, "A Ciphertext-policy attribute-based proxy re-encryption with chosen-ciphertext security," in Proc. INCoS 2013, Xian, China, Sep. 2013, pp. 552-559.
- Katipamula, Srinivas, and Michael R. Brambley. "Review article: methods for fault detection, diagnostics, and prognostics for building systemsa review, Part I." HVAC&R Research 11.1 (2005): 3-25.
- Katipamula, Srinivas, and Michael R. Brambley. "Review article: methods for fault detection, diagnostics, and prognostics for building systemsa review, Part II." HVAC&R Research 11.2 (2005): 169-187.
- L. Zhou, V. Varadharajan, and M. Hitchens, "Achieving secure role-based access control on encrypted data in cloud storage," IEEE Trans. Inf. Forensics Security, vol. 8, No. 12, pp. 1947-1960, Dec. 2013.
- Li, Wenjia, Anupam Joshi, and Tim Finin. "Coping with node misbehaviors in ad hoc networks: A multi-dimensional trust management approach." Mobile Data Management (MDM), 2010 Eleventh International Conference on. IEEE, 2010.
- Lopez, Javier, et al. "Trust management systems for wireless sensor networks: Best practices." Computer Communications 33.9 (2010): 1086-1093.
- M. Blaze, G. Bleumer, and M. Strauss, 'Divertible protocols and atomic proxy cryptography,' in Proc. EUROCRYPT 1998, Espoo, Finland, May-Jun. 1998, pp. 127-144.
- M. Green and G. Ateniese, "Identity-based proxy re-encryption," in Proc. ACNS 2007, Zhuhai, China, Jun. 2007, pp. 288-306.
- M. Ion, J. Zhang, and E.M. Schooler, "Toward content-centric privacy in ICN: Attribute-based encryption and routing," in Proc. ACM SIGCOMM ICN 2013, Hong Kong, China, Aug. 2013, pp. 39-40.
- M. Naor and B. Pinkas "Efficient trace and revoke schemes," in Proc. FC 2000, Anguilla, British West Indies, Feb. 2000, pp. 1-20.
- M. Nystrom, S. Parkinson, A. Rusch, and M. Scott, "PKCS#12: Personal information exchange syntax v. 1.1," IETF RFC 7292, K. Moriarty, Ed., Jul. 2014.
- M. Parsa and J.J. Garcia-Luna-Aceves, "A Protocol for Scalable Loop-free Multicast Routing." IEEE JSAC, Apr. 1997.
- M. Walfish, H. Balakrishnan, and S. Shenker. "Untangling the web from DNS," in Proc. USENIX NSDI 2004, Oct. 2010, pp. 735-737.
- Mahadevan, Priya, et al. "Orbis: rescaling degree correlations to generate annotated internet topologies." ACM SIGCOMM Computer Communication Review. vol. 37. No. 4. ACM, 2007.
- Mahadevan, Priya, et al. "Systematic topology analysis and generation using degree correlations." ACM SIGCOMM Computer Communication Review. vol. 36. No. 4. ACM, 2006.
- Matocha, Jeff, and Tracy Camp. 'A taxonomy of distributed termination detection algorithms.' Journal of Systems and Software 43.3 (1998): 207-221.
- Matteo Varvello et al., "Caesar: A Content Router for High Speed Forwarding", ICN 2012, Second Edition on Information-Centric Networking, New York, Aug. 2012.
- McWilliams, Jennifer A., and Iain S. Walker. "Home Energy Article: A Systems Approach to Retrofitting Residential HVAC Systems." Lawrence Berkeley National Laboratory (2005).
- Merindol et al., "An efficient algorithm to enable path diversity in link state routing networks", Jan. 10, Computer Networks 55 (2011), pp. 1132-1140.
- Mobility First Project [online], <http://mobilityfirst.winlab.rutgers.edu/>, Downloaded Mar. 9, 2015.
- Narasimhan, Sriram, and Lee Brownston. "HyDE—A General Framework for Stochastic and Hybrid Modelbased Diagnosis." Proc. DX 7 (2007): 162-169.



(56)

## References Cited

## OTHER PUBLICATIONS

- Omar, Mawloud, Yacine Challal, and Abdelmadjid Bouabdallah. "Certification-based trust models in mobile ad hoc networks: A survey and taxonomy." *Journal of Network and Computer Applications* 35.1 (2012): 268-286.
- P. Mahadevan, E.Uzun, S. Sevilla, and J. Garcia-Luna-Aceves, "CCN-krs: A key resolution service for ccn," in *Proceedings of the 1st International Conference on Information-centric Networking*, Ser. INC 14 New York, NY, USA: ACM, 2014, pp. 97-106. [Online]. Available: <http://doi.acm.org/10.1145/2660129.2660154>.
- R. H. Deng, J. Weng, S. Liu, and K. Chen. Chosen-Ciphertext Secure Proxy Re-Encryption without Pairings. *CANS*. Spring Lecture Notes in Computer Science vol. 5339 (2008).
- Rosenberg, J. "Interactive Connectivity Establishment (ICE): A Protocol for Network Address Translator (NAT) Traversal for Offer/Answer Protocols", Apr. 2010, pp. 1-117.
- S. Chow, J. Weng, Y. Yang, and R. Deng. Efficient Unidirectional Proxy Re-Encryption. *Progress in Cryptology—AFRICACRYPT 2010*. Springer Berlin Heidelberg (2010).
- S. Deering, "Multicast Routing in Internetworks and Extended LANs," *Proc. ACM SIGCOMM '88*, Aug. 1988.
- S. Deering et al., "The PIM architecture for wide-area multicast routing," *IEEE/ACM Trans. on Networking*, vol. 4, No. 2, Apr. 1996.
- S. Jahid, P. Mittal, and N. Borisov, "EASIER: Encryption-based access control in social network with efficient revocation," in *Proc. ACM ASIACCS 2011*, Hong Kong, China, Mar. 2011, pp. 411-415.
- S. Kamara and K. Lauter, "Cryptographic cloud storage," in *Proc. FC 2010*, Tenerife, Canary Islands, Spain, Jan. 2010, pp. 136-149.
- S. Kumar et al. "Peacock Hashing: Deterministic and Updateable Hashing for High Performance Networking," 2008, pp. 556-564.
- S. Misra, R. Tourani, and N.E. Majd, "Secure content delivery in information-centric networks: Design, implementation, and analyses," in *Proc. ACM SIGCOMM ICN 2013*, Hong Kong, China, Aug. 2013, pp. 73-78.
- S. Yu, C. Wang, K. Ren, and W. Lou, "Achieving secure, scalable, and fine-grained data access control in cloud computing," in *Proc. IEEE INFOCOM 2010*, San Diego, CA, USA, Mar. 2010, pp. 1-9.
- S.J. Lee, M. Gerla, and C. Chiang, "On-demand Multicast Routing Protocol in Multihop Wireless Mobile Networks," *Mobile Networks and Applications*, vol. 7, No. 6, 2002.
- Sandvine, *Global Internet Phenomena Report—Spring 2012*. Located online at [http://www.sandvine.com/downloads/documents/Phenomenal\\_H\\_2012/Sandvine\\_Global\\_Internet\\_Phenomena\\_Report\\_IH\\_2012.pdf](http://www.sandvine.com/downloads/documents/Phenomenal_H_2012/Sandvine_Global_Internet_Phenomena_Report_IH_2012.pdf).
- Schein, Jeffrey, and Steven T. Bushby. *A Simulation Study of a Hierarchical, Rule-Based Method for System-Level Fault Detection and Diagnostics in HVAC Systems*. US Department of Commerce, [Technology Administration], National Institute of Standards and Technology, 2005.
- Shani, Guy, Joelle Pineau, and Robert Kaplow. "A survey of point-based POMDP solvers." *Autonomous Agents and Multi-Agent Systems* 27.1 (2013): 1-51.
- Sheppard, John W., and Stephyn GW Butcher. "A formal analysis of fault diagnosis with d-matrices." *Journal of Electronic Testing* 23.4 (2007): 309-322.
- Shih, Eugene et al., "Wake on Wireless: An Event Driven Energy Saving Strategy for Battery Operated Devices", Sep. 23, 2002, pp. 160-171.
- Shneyderman, Alex et al., "Mobile VPN: Delivering Advanced Services in Next Generation Wireless Systems", Jan. 1, 2003, pp. 3-29.
- Solis, Ignacio, and J. J. Garcia-Luna-Aceves. "Robust content dissemination in disrupted environments." *proceedings of the third ACM workshop on Challenged networks*. ACM, 2008.
- Sun, Ying, and Daniel S. Weld. "A framework for model-based repair." *AAAI*. 1993.
- T. Ballardie, P. Francis, and J. Crowcroft, "Core Based Trees (CBT)," *Proc. ACM SIGCOMM '88*, Aug. 1988.
- T. Dierks, "The transport layer security (TLS) protocol version 1.2," IETF RFC 5246, 2008.
- T. Koponen, M. Chawla, B.-G. Chun, A. Ermolinskiy, K.H. Kim, S. Shenker, and I. Stoica, 'A data-oriented (and beyond) network architecture,' *ACM SIGCOMM Computer Communication Review*, vol. 37, No. 4, pp. 181-192, Oct. 2007.
- The Despotify Project (2012). Available online at <http://despotify.sourceforge.net/>.
- V. Goyal, O. Pan Dey, A. Sahai, and B. Waters, "Attribute-based encryption for fine-grained access control of encrypted data," in *Proc. ACM CCS 2006*, Alexandria, VA, USA, Oct.-Nov. 2006, pp. 89-98.
- V. Jacobson, D.K. Smetters, J.D. Thornton, M.F. Plass, N.H. Briggs, and R.L. Braynard, 'Networking named content,' in *Proc. Acn CoNEXT 2009*, Rome, Italy, Dec. 2009, pp. 1-12.
- V. K. Adhikari, S. Jain, Y. Chen, and Z.-L. Zhang. *Vivisectioning Youtube: An Active Measurement Study*. In *INFOCOM12 Mini-conference* (2012).
- Verma, Vand, Joquin Fernandez, and Reid Simmons. "Probabilistic models for monitoring and fault diagnosis." *The Second IARP and IEEE/RAS Joint Workshop on Technical Challenges for Dependable Robots in Human Environments*. Ed. Raja Chatila. Oct. 2002.
- Vijay Kumar Adhikari, Yang Guo, Fang Hao, Matteo Varvello, Volker Hilt, Moritz Steiner, and Zhi-Li Zhang. *Unreeling Netflix: Understanding and Improving Multi-CDN Movie Delivery*. In *the Proceedings of IEEE INFOCOM 2012* (2012).
- Vutukury, Srinivas, and J. J. Garcia-Luna-Aceves. A simple approximation to minimum-delay routing. vol. 29. No. 4. ACM, 1999.
- W.-G. Tzeng and Z.-J. Tzeng, "A public-key traitor tracing scheme with revocation using dynamic shares," in *Proc. PKC 2001*, Cheju Island, Korea, Feb. 2001, pp. 207-224.
- Waldvogel, Marcel "Fast Longest Prefix Matching: Algorithms, Analysis, and Applications", A dissertation submitted to the Swiss Federal Institute of Technology Zurich, 2002.
- Walker, Iain S. *Best practices guide for residential HVAC Retrofits*. No. LBNL-53592. Ernest Orlando Lawrence Berkeley National Laboratory, Berkeley, CA (US), 2003.
- Wang, Jiangzhe et al., "DMND: Collecting Data from Mobiles Using Named Data", *Vehicular Networking Conference*, 2010 IEEE, pp. 49-56.
- Yi, Cheng, et al. 'A case for stateful forwarding plane.' *Computer Communications* 6.7 (2013): 779-791.
- Yi, Cheng, et al. 'Adaptive forwarding in named data networking.' *ACM SIGCOMM computer communication review* 42.3 (2012): 62-67.
- Zahariadis, Theodore, et al. "Trust management in wireless sensor networks." *European Transactions on Telecommunications* 21.4 (2010): 386-395.
- Zhang, et al., "Named Data Networking (NDN) Project", <http://www.parc.com/publication/2709/named-data-networking-ndn-project.html>, Oct. 2010. NDN-0001, PARC Tech Report.
- Zhang, Lixia, et al. 'Named data networking.' *ACM SIGCOMM Computer Communication Review* 44.3 (2014): 66-73.
- Soh et al., "Efficient Prefix Updates for IP Router Using Lexicographic Ordering and Updateable Address Set", Jan. 2008, *IEEE Transactions On Computers*, vol. 57, No. 1.
- Beben et al., "Content Aware Network based on Virtual Infrastructure", 2012 13th ACIS International Conference on Software Engineering.
- D. Trossen and G. Parisi, "Designing and realizing an information-centric internet," *IEEE Communications Magazine*, vol. 50, No. 7, pp. 60-67, Jul. 2012.
- Garcia-Luna-Aceves et al., "Automatic Routing Using Multiple Prefix Labels", 2012, *IEEE, Ad Hoc and Sensor Networking Symposium*.
- Gast, Paolo et al., "DoS & DDoS in Named Data Networking", 2013 22nd International Conference on Computer Communications and Networks (ICCCN), Aug. 2013, pp. 1-7.
- Ishiyama, "On the Effectiveness of Diffusive Content Caching in Content-Centric Networking". Nov. 5, 2012, *IEEE, Information and Telecommunication Technologies (APSITT)*, 2012 9th Asia-Pacific Symposium.

(56)

## References Cited

## OTHER PUBLICATIONS

- J. Hur and D.K. Noh, "Attribute-based access control with efficient revocation in data outsourcing systems," *IEEE Trans. Parallel Distrib. Syst.*, vol. 22, No. 7, pp. 1214-1221, Jul. 2011.
- J. Lotspiech, S. Nusser, and F. Pestoni. Anonymous Trust: Digital Rights Management using Broadcast Encryption. Proceedings of the IEEE 92.6 (2004).
- Kaya et al., "A Low Power Lookup Technique for Multi-Hashing Network Applications", 2006 IEEE Computer Society Annual Symposium on Emerging VLSI Technologies and Architectures, Mar. 2006.
- S. Kamara and K. Lauter. Cryptographic Cloud Storage. *Financial Cryptography and Data Security*. Springer Berlin Heidelberg (2010).
- RTMP (2009). Available online at [http://www.images.adobe.com/www.adobe.com/content/dam/Adobe/en/devnet/rtmp/pdf/rtmp\\_specification\\_1.0.pdf](http://www.images.adobe.com/www.adobe.com/content/dam/Adobe/en/devnet/rtmp/pdf/rtmp_specification_1.0.pdf).
- Hoque et al., "NLSR: Named-data Link State Routing Protocol", Aug. 12, 2013, ICN'13.
- Nadeem Javaid, "Analysis and design of quality link metrics for routing protocols in Wireless Networks", PhD Thesis Defense, Dec. 15, 2010, Universite Paris-Est.
- Wetherall, David, "Active Network vision and reality: Lessons from a capsule-based system", *ACM Symposium on Operating Systems Principles*, Dec. 1, 1999, pp. 64-79.
- Kulkarni A.B. et al., "Implementation of a prototype active network", *IEEE, Open Architectures and Network Programming*, Apr. 3, 1998, pp. 130-142.
- Ahlgren, Bengt, et al. "A survey of information-centric networking." *Communications Magazine*, IEEE 50.7 (2012): 26-36.
- Content Centric Networking Project (CCN) {online} <http://www.ccnx.org/releases/latest/doc/technical>.
- Content Mediator Architecture for Content-aware Networks (COMET) Project {online} <http://www.comet-project.org/>.
- Detti, Andrea, et al. "CONET: a content centric inter-networking architecture." Proceedings of the ACM SIGCOMM workshop on Information-centric networking. ACM, 2011.
- Gupta, Anjali, Barbara Liskov, and Rodrigo Rodrigues. "Efficient Routing for Peer-to-Peer Overlays." *NSDI*. vol. 4. 2004.
- Jacobson, Van, et al. "Networking named content." Proceedings of the 5th international conference on Emerging networking experiments and technologies. ACM, 2009.
- Hogue, A. K. M., et al. "Nlsr: Named-data link state routing protocol." Proceedings of the 3rd ACM SIGCOMM Workshop on Information-centric Networking. ACM, 2013.
- NDN Project {online} <http://www.named-data.net/>.
- Publish Subscribe Internet Technology (PURSUIT) Project {online} <http://www.fp7-pursuit.eu/pursuitweb>.
- Scalable and Adaptive Internet Solutions (SAIL) Project {online} <http://www.sail-project.eu/>.
- Wang, Lan, et al. "OSPFN: An OSPF based routing protocol for Named Data Networking." University of Memphis and University of Arizona, Tech. Rep (2012).
- Xylomenos, George, et al. "A survey of information-centric networking research." *Communications Surveys & Tutorials*, IEEE 16.2 (2014): 1024-1049.
- Lui et al. (A TLV-Structured Data Naming Scheme for Content-Oriented Networking, pp. 5822-5827, International Workshop on the Network of the Future, Communications (ICC), 2012 IEEE International Conference on Jun. 10-15, 2012).
- Peter Dely et al. "OpenFlow for Wireless Mesh Networks" *Computer Communications and Networks*, 2011 Proceedings of 20th International Conference on, IEEE, Jul. 31, 2011 (Jul. 31, 2011), pp. 1-6.
- Garnepudi Parimala et al "Proactive, reactive and hybrid multicast routing protocols for Wireless Mesh Networks", 2013 IEEE International Conference on Computational Intelligence and Computing Research, IEEE, Dec. 26, 2013, pp. 1-7.
- Tiancheng Zhuang et al. "Managing Ad Hoc Networks of Smartphones", *International Journal of Information and Education Technology*, Oct. 1, 2013.
- Amadeo et al. "Design and Analysis of a Transport-Level Solution for Content-Centric VANETs", University "Mediterranea" of Reggio Calabria, Jun. 15, 2013.
- Marc Mosko: "CCNx 1.0 Protocol Introduction" Apr. 2, 2014 [Retrieved from the Internet Jun. 8, 2016] <http://www.ccnx.org/pubs/hhg/1.1%20CCNx%201.0%20Protocol%20Introduction.pdf> \*paragraphs [01.3], [002], [02.1], [0003].
- Akash Baid et al: "Comparing alternative approaches for networking of named objects in the future Internet", *Computer Communications Workshops (Infocom Wkshps)*, 2012 IEEE Conference on, IEEE, Mar. 25, 2012, pp. 298-303, \*Paragraph [002]\* \*figure 1\*.
- Priya Mahadevan: "CCNx 1.0 Tutorial", Mar. 16, 2014, pp. 1-11, Retrieved from the Internet: <http://www.ccnx.org/pubs/hhg/1.2%20CCNx%201.0%20Tutorial.pdf> [retrieved on Jun. 8, 2016] \*paragraphs [003]-[006], [0011], [0013]\* \*figures 1,2\*.
- Marc Mosko et al "All-In-One Streams for Content Centric Networks", May 24, 2015, retrieved from the Internet: <http://www.ccnx.org/pubs/AllinOne.pdf> [downloaded Jun. 9, 2016] \*the whole document\*.
- Cesar Ghali et al. "Elements of Trust in Named-Data Networking", Feb. 13, 2014 Retrieved from the internet Jun. 17, 2016 <http://arxiv.org/pdf/1402.3332v5.pdf> \*p. 5, col. 1\* \*p. 2, col. 1-2\* \*Section 4.1; p. 4, col. 2\* \*Section 4.2; p. 4, col. 2\*.
- Priya Mahadevan et al. "CCN-KRS", Proceedings of the 1st International Conference on Information-Centric Networking, Inc. '14, Sep. 24, 2014.
- Flavio Roberto Santos Et al. "Funnel: Choking Polluters in BitTorrent File Sharing Communities", *IEEE Transactions on Network and Service Management*, IEEE vol. 8, No. 4, Dec. 1, 2011.
- Liu Wai-Xi et al: "Multisource Dissemination in content-centric networking", 2013 Fourth International conference on the network of the future (NOF), IEEE, Oct. 23, 2013, pp. 1-5.
- Marie-Jose Montpetit et al.: "Network coding meets information-centric networking", Proceedings of the 1st ACM workshop on emerging Name-Oriented mobile networking design, architecture, algorithms, and applications, NOM '12, Jun. 11, 2012, pp. 31-36.
- Asokan et al.: "Server-Supported Signatures", *Computer Security Esorics* 96, Sep. 25, 1996, pp. 131-143, Section 3.
- Mandl et al.: "A Fast FPGA Based Coprocessor Supporting Hard Real-Time Search", *New Frontiers of Information Technology*, Proceedings of the 23rd Euromicro Conference Budapest, Sep. 1, 1997, pp. 499-506 \*The Whole Document\*.
- Sun et al.: "Content-Based Route Lookup Using CAMs", *Global Communications Conference*, IEEE, Dec. 3, 2012 \*The Whole Document\*.
- Xie et al. "Collaborative Forwarding and Caching in Content Centric Networks", *Networking* 2012.
- Boneh, et al., "Collusion Resistant Broadcast Encryption with Short Ciphertexts and Private Keys," *Advances in Cryptology—CRYPTO 2005*, Aug. 2005, 19 pages.
- Xiong, et al., "CloudSeal: End-to-End Content Protection in Cloud-Based Storage and Delivery Services," *SecureComm 2011: Security and Privacy in Communication Networks*, Sep. 2011, 10 pages.
- Ateniese, et al., "Improved Proxy Re-encryption Schemes with Applications to Secure Distributed Storage," *ACM Transactions on Information and System Security (TISSEC)*, vol. 9 Issue 1, Feb. 2006, 30 pages.
- Biradar, et al., "Review of Multicast Routing Mechanisms in Mobile Ad Hoc Networks," *Journal of network and Computer Applications*, vol. 35, Issue 1, Jan. 2012, 19 pages.
- Lynn, "PBC Library—Pairing-Based Cryptography," retrieved from <https://crypto.stanford.edu/pbc/>, on Apr. 27, 2015, 2 pages.

\* cited by examiner

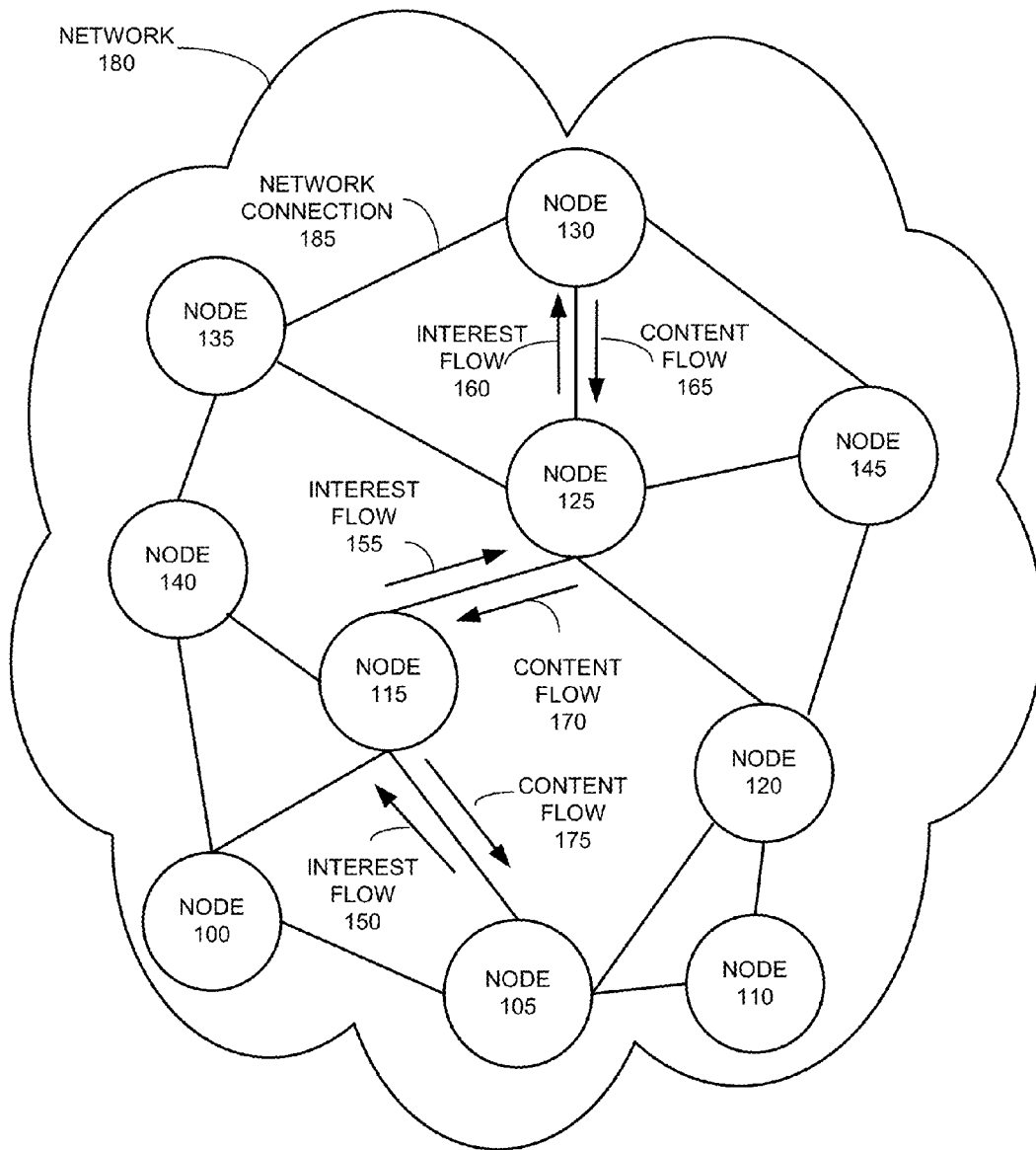

FIG. 1

TOPOLOGY TABLE 200

LINK ID	COST OF THE LINK	MOST RECENT SEQUENCE NUMBER	AGE
...	...	...	...
$(u,v)$	$l^u$	$sn^u$	$t^u$
...	...	...	...

LSAs for physical links

---

PREFIX	ANCHOR ROUTER	MOST RECENT SEQUENCE NUMBER	AGE
...	...	...	...
$j$	$k$	$sn^k$	$t^k$
...	...	...	...

LSAs for prefixes

202

204

FIG. 2

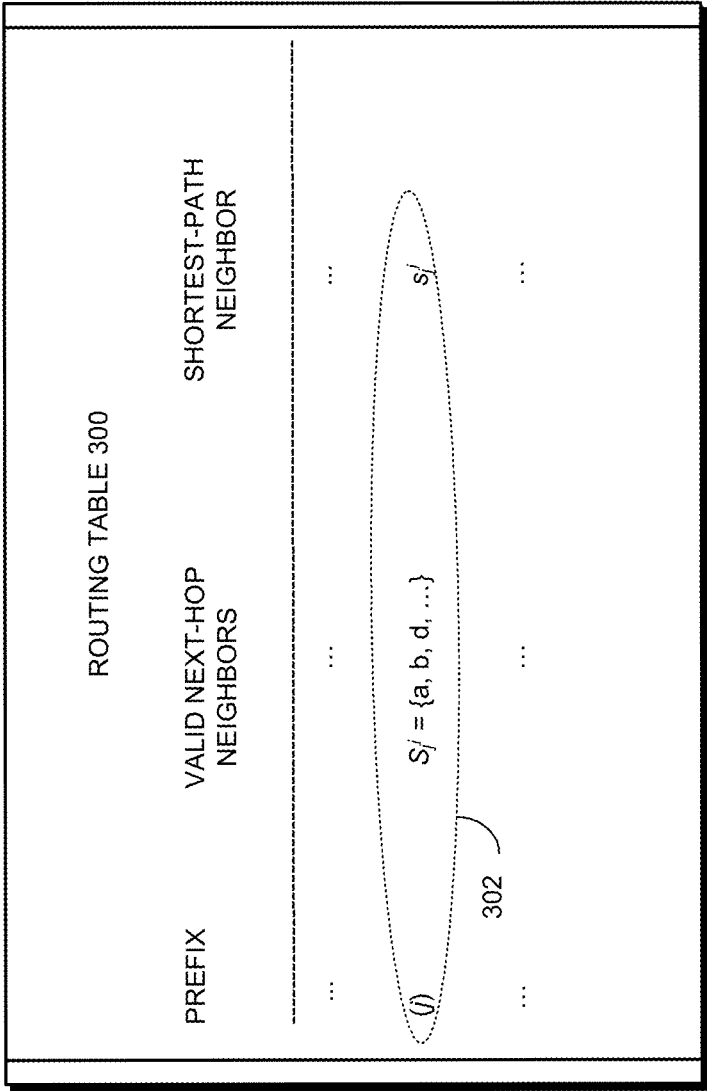

FIG. 3

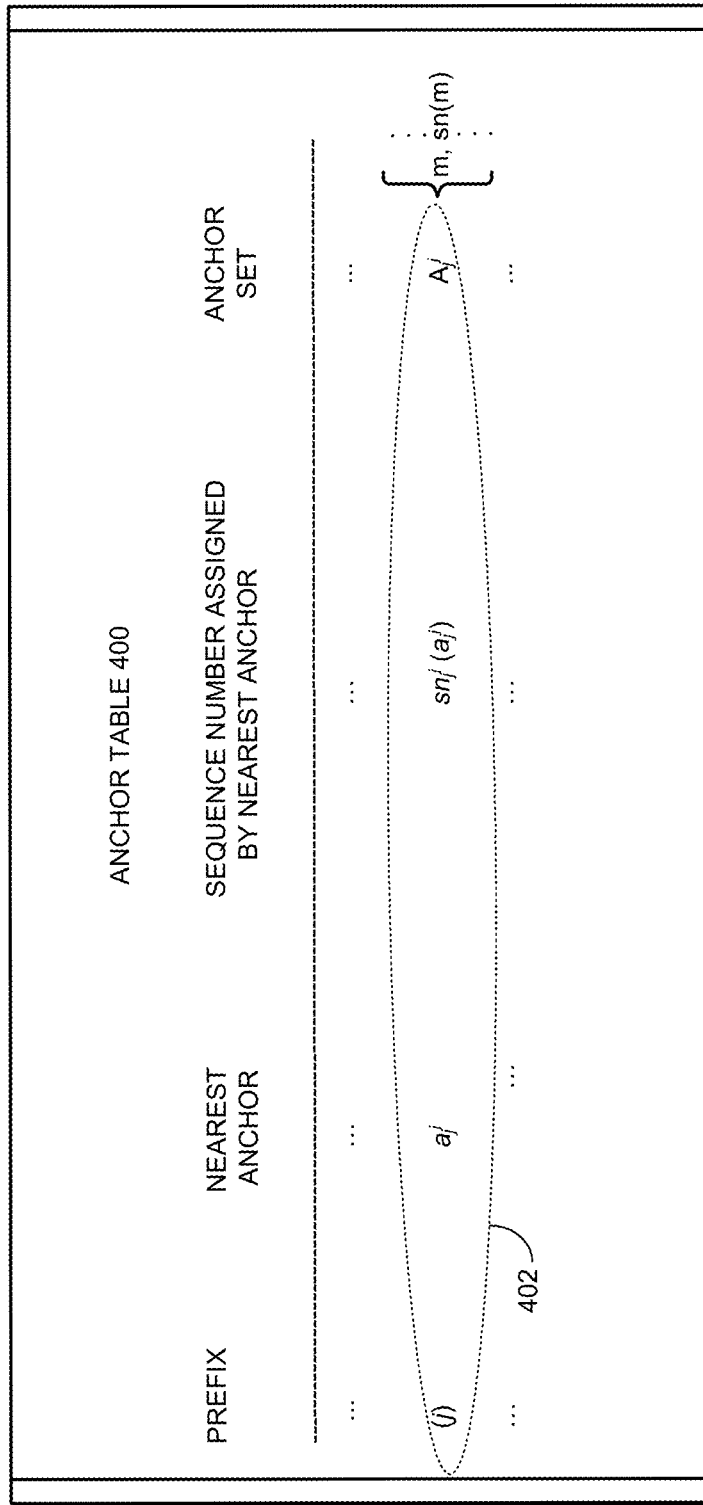

FIG. 4

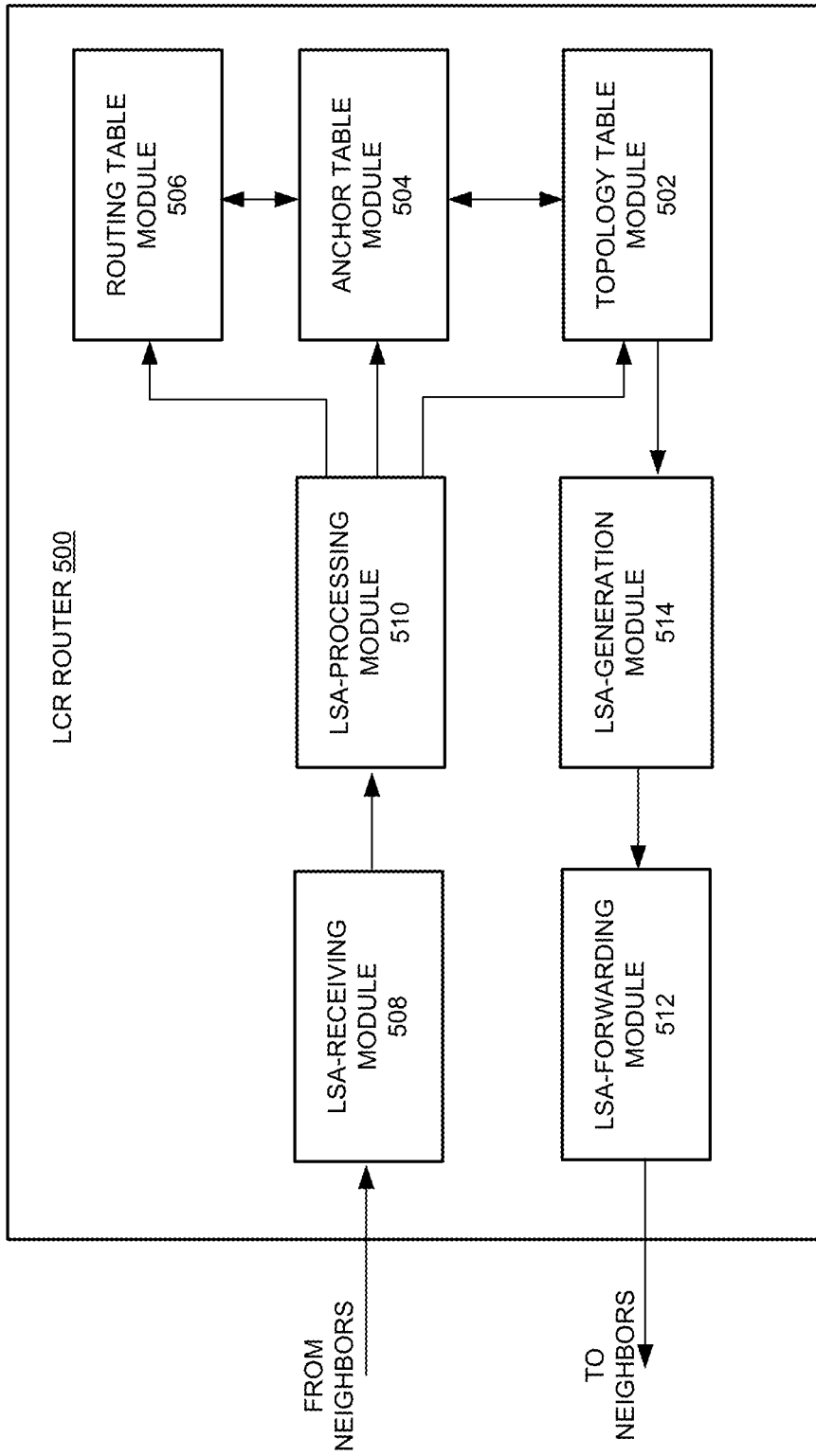
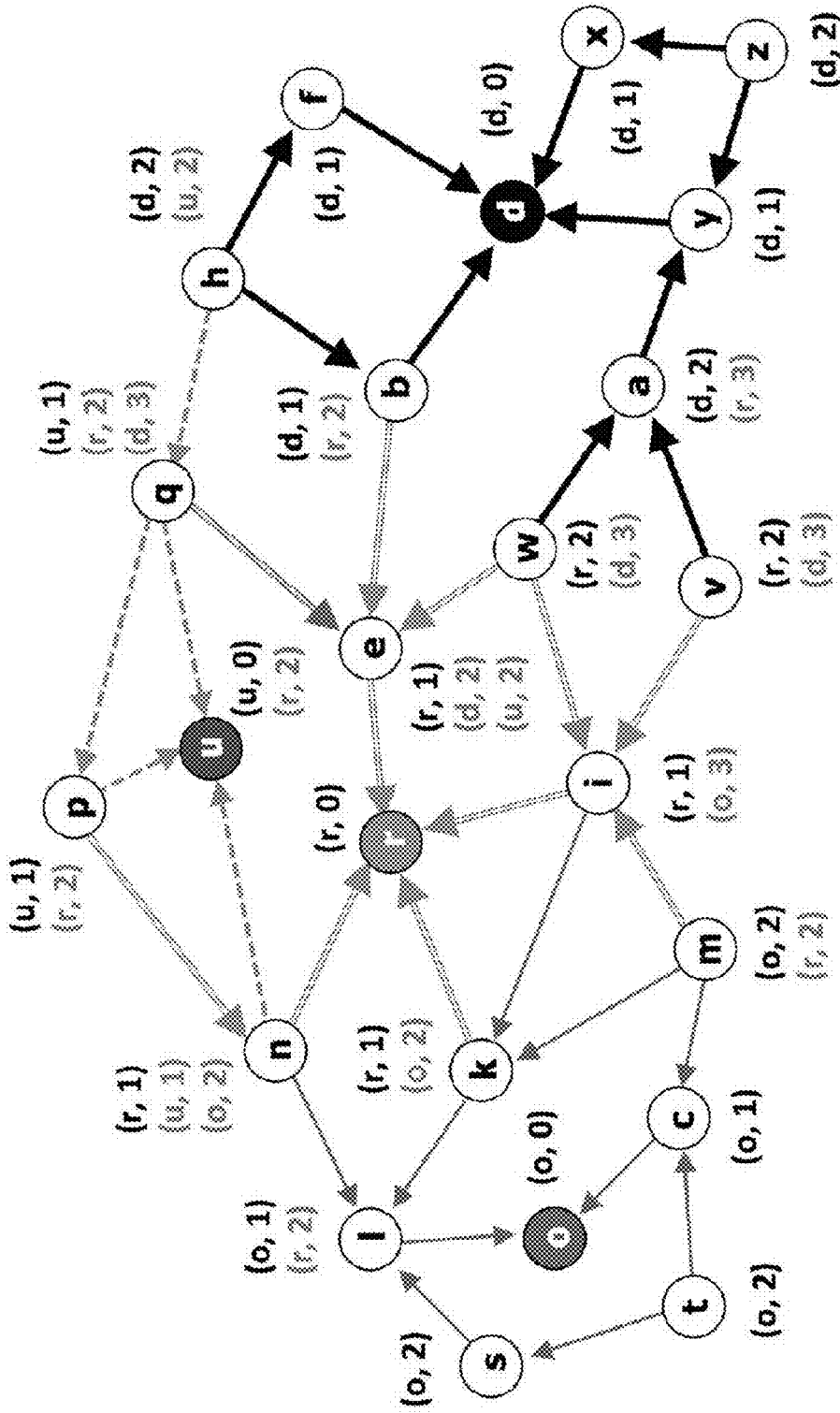

FIG. 5



600

FIG. 6



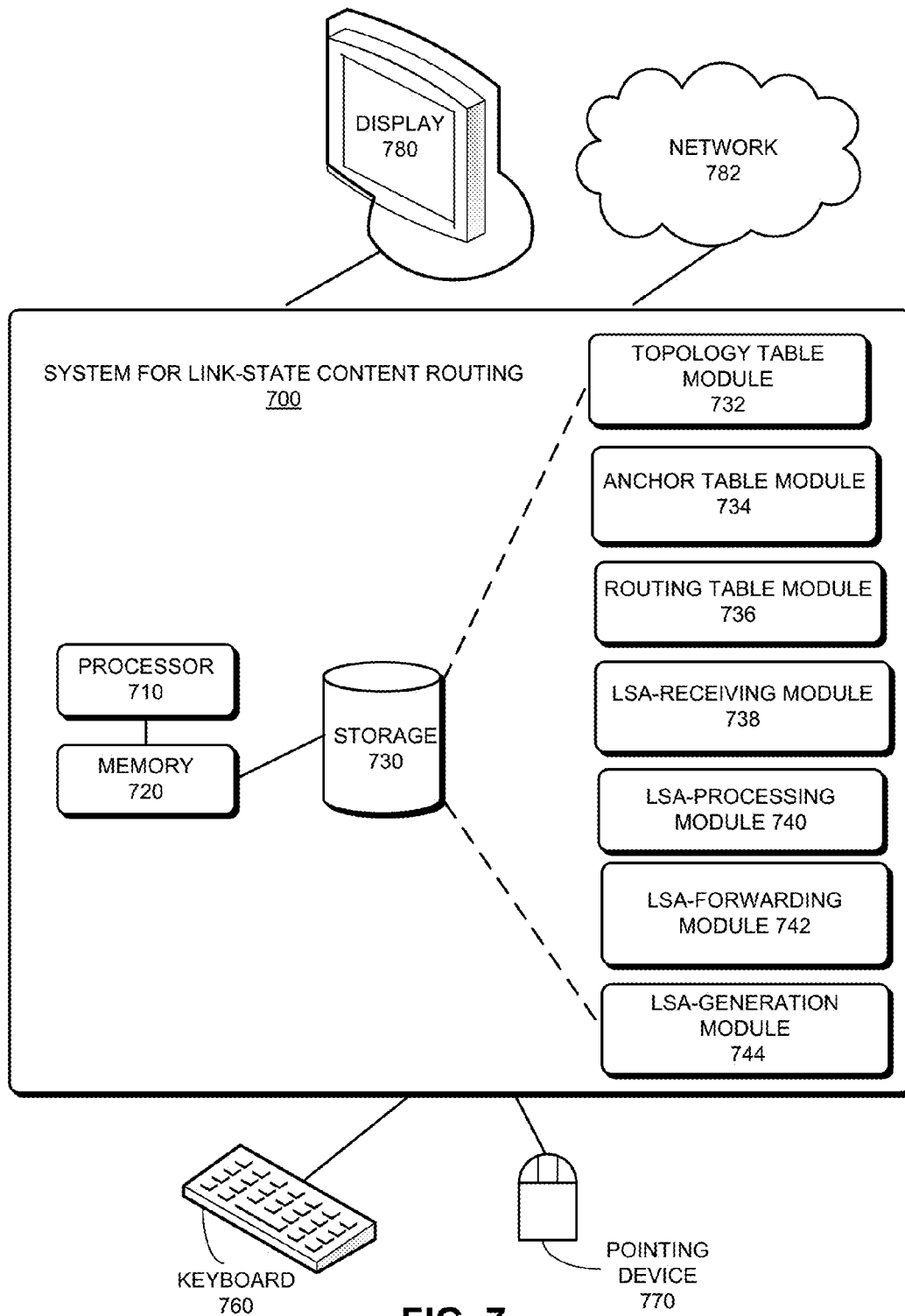

FIG. 7

**SYSTEM AND METHOD FOR EFFICIENT  
NAME-BASED CONTENT ROUTING USING  
LINK-STATE INFORMATION IN  
INFORMATION-CENTRIC NETWORKS**

BACKGROUND

Field

The present disclosure relates generally to an information-centric network (ICN). More specifically, the present disclosure relates to a system and method for content routing using link-state information in ICNs.

Related Art

The proliferation of the Internet and e-commerce continues to fuel revolutionary changes in the network industry. Today, a significant number of information exchanges, from online movie viewing to daily news delivery, retail sales, and instant messaging, are conducted online. An increasing number of Internet applications are also becoming mobile. However, the current Internet operates on a largely location-based addressing scheme. The two most ubiquitous protocols, the Internet Protocol (IP) and Ethernet protocol, are both based on end-host addresses. That is, a consumer of content can only receive the content by explicitly requesting the content from an address (e.g., IP address or Ethernet media access control (MAC) address) that is typically associated with a physical object or location. This restrictive addressing scheme is becoming progressively more inadequate for meeting the ever-changing network demands.

Recently, information-centric network (ICN) architectures have been proposed in the industry where content is directly named and addressed. Content-Centric Networking (CCN), an exemplary ICN architecture brings a new approach to content transport. Instead of having network traffic viewed at the application level as end-to-end conversations over which content travels, content is requested or returned based on its unique name, and the network is responsible for routing content from the provider to the consumer. Note that content includes data that can be transported in the communication system, including any form of data such as text, images, video, and/or audio. A consumer and a provider can be a person at a computer or an automated process inside or outside the ICN. A piece of content can refer to the entire content or a respective portion of the content. For example, a newspaper article might be represented by multiple pieces of content embodied as data packets. A piece of content can also be associated with metadata describing or augmenting the piece of content with information such as authentication data, creation date, content owner, etc.

At the core of all ICN architectures are name resolution and routing of content, and several approaches have been proposed. In some ICN architectures, the names of data objects are mapped into addresses by means of directory servers, and then address-based routing is used for content delivery. By contrast, a number of ICN architectures use name-based routing of content, which integrates name resolution and content routing. With name-based routing, some of the routers (producers or caching sites) advertise the existence of local copies of named data objects (NDO) or name prefixes denoting a set of objects with names sharing a common prefix, and routes to them are established; the consumers of content issue content requests that are forwarded along the routes to the routers that issued the NDO or name prefix advertisements.

Among the various ICN architectures, CCN uses distributed routing protocols to establish routes over which content

requests are forwarded. In CCN, a content request (called an "Interest") may be sent over one or multiple paths to a name prefix. Some CCN schemes use existing Internet routing protocol, such as link-state Interior Gateway Protocol (IGP), for intra-domain routing, where routers describe their local connectivity and adjacent resources (content). It has also been proposed to integrate domain-level content prefixes into existing Border Gateway Protocol (BGP) to solve the problem of inter-domain content routing.

Exemplary content routing schemes in ICNs include NLSR (Named-data Link State Routing Protocol) and OSPFN (OSPN for Named-data). In both protocols, routers exchange topology information by flooding two types of link-state advertisements (LSA). LSAs can describe the state of physical links just as it is done in traditional link-state routing protocols. In addition, routers flood LSAs about the prefixes for which they have local copies. It is also possible to use distributed hash tables (DHT) running in overlays over the physical infrastructure to accomplish name-based routing, and in such situations, the routing protocol used in the underlay typically consists of a link-state protocol.

One of the problems facing the existing link-state based routing protocols is that they require each router to receive information, such as LSAs, about all replicas of each published named data object or name prefix advertised in the network, and hence are not scalable.

SUMMARY

One embodiment of the present invention provides a system for updating link-status information associated with a prefix in an information-centric network (ICN). During operation, a first node in the ICN receives a link-state advertisement (LSA) message from a neighbor node with the LSA message specifying a prefix and an anchor node advertising the specified prefix. The system determines, based on topology information stored on the first node, whether a shortest-path condition is met, and forwards the received LSA message to other neighbors of the first node in response to the shortest-path condition being met.

In a variation on this embodiment, determining whether the shortest-path condition is met involves computing, using a shortest-path first (SPF) algorithm, a shortest distance from the first node to the specified prefix.

In a variation on this embodiment, the first node generates an LSA message reflecting a status change to a local prefix and forwards the generated LSA message to neighbors of the first node.

In a variation on this embodiment, the first node updates a routing table based on the received LSA message.

In a further variation, updating the routing table involves identifying a set of valid next-hop neighbors to the prefix, and identifying a respective valid next-hop neighbor involves determining whether the valid next-hop neighbor is closer to the anchor node than the first node, thereby preventing formation of a loop in the updated routing table.

In a further variation, in response to the valid next-hop neighbor having a same distance to the anchor node as that of the first node, the system determines whether the valid next-hop neighbor has a smaller lexicographic value compared with the first node.

In a variation on this embodiment, the LSA message further includes a sequence number created by the anchor node, and the sequence number increments each time the anchor node updates the LSA message for the specified prefix.

## BRIEF DESCRIPTION OF THE FIGURES

FIG. 1 illustrates an exemplary architecture of a network, in accordance with an embodiment of the present invention.

FIG. 2 presents a diagram illustrating an exemplary topology table maintained at a router, in accordance with an embodiment of the present invention.

FIG. 3 presents a diagram illustrating an exemplary routing table maintained at a router, in accordance with an embodiment of the present invention.

FIG. 4 presents a diagram illustrating an exemplary anchor table maintained at a router, in accordance with an embodiment of the present invention.

FIG. 5 presents a diagram presenting an exemplary architecture of a router that implements LCR, in accordance with an embodiment of the present invention.

FIG. 6 presents an LCR routing example, in accordance with an embodiment of the present invention.

FIG. 7 illustrates an exemplary system for link-state content routing, in accordance with an embodiment of the present invention.

In the figures, like reference numerals refer to the same figure elements.

## DETAILED DESCRIPTION

## Overview

Embodiments of the present invention provide a system for content routing based on link-state information in an information-centric network (ICN). More specifically, the link-state content routing (LCR) system operates by having routers maintain a number of tables, including a link cost table, a topology table, a routing table, and an anchor table. Information stored in these tables can be updated periodically by routers. The topology table is updated when a router receives link-state advertisements (LSAs) from its neighbors. The routing table can be computed and updated by means of the shortest path first (SPF) algorithm. Compared with conventional link-state based routing, in the LCR system, routers do not flood the network LSAs regarding all replicas of a name prefix. Instead, an LSA regarding a name prefix is set up in such a way that each router reports only one replica (often the nearest) for each name prefix.

## Exemplary CCN Architecture

To demonstrate the operations of a link-state content routing (LCR) system, this disclosure uses CCN as an example. However, the operations of the LCR system is not limited to CCN. In general, LCR can be applied to any other type of ICN networks.

CCN uses two types of messages: Interests and Content Objects. An Interest carries the hierarchically structured variable-length identifier (HSVLI), also called the "name," of a Content Object and serves as a request for that object. If a network element (e.g., router) receives multiple Interests for the same name, it may aggregate those Interests. A network element along the path of the Interest with a matching Content Object may cache and return that object, satisfying the Interest. The Content Object follows the reverse path of the Interest to the origin(s) of the Interest.

The terms used in the present disclosure are generally defined as follows (but their interpretation is not limited to such):

"HSVLI:" Hierarchically structured variable-length identifier, also called a Name. It is an ordered list of Name Components, which may be variable length octet strings. In human-readable form, it can be represented

in a format such as ccnx:/path/part. Also the HSVLI may not be human readable. As mentioned above, HSVLIs refer to content, and it is desirable that they be able to represent organizational structures for content and be at least partially meaningful to humans. An individual component of an HSVLI may have an arbitrary length. Furthermore, HSVLIs can have explicitly delimited components, can include any sequence of bytes, and are not limited to human-readable characters. A longest-prefix-match lookup is important in forwarding packets with HSVLIs. For example, an HSVLI indicating an Interest in "/parc/home/bob" will match both "/parc/home/bob/test.txt" and "/parc/home/bob/bar.txt." The longest match, in terms of the number of name components, is considered the best because it is the most specific. Detailed descriptions of the HSVLIs can be found in U.S. Pat. No. 8,160,069, entitled "SYSTEM FOR FORWARDING A PACKET WITH A HIERARCHICALLY STRUCTURED VARIABLE-LENGTH IDENTIFIER," by inventors Van L. Jacobson and James D. Thornton, filed 23 Sep. 2009, the disclosure of which is incorporated herein by reference in its entirety.

"Interest:" A request for a Content Object. The Interest specifies an HSVLI name prefix and other optional selectors that can be used to choose among multiple objects with the same name prefix. Any Content Object whose name matches the Interest name prefix (and optionally other requested parameters such as publisher key-ID match) satisfies the Interest.

"Content Object:" A data object sent in response to an Interest. It has an HSVLI name and a Content payload that are bound together via a cryptographic signature. Optionally, all Content Objects have an implicit terminal name component made up of the SHA-256 digest of the Content Object. In one embodiment, the implicit digest is not transferred on the wire, but is computed at each hop, if needed. In this disclosure, the term "Content Object" and the term "Named Data Object (NDO)" are interchangeable.

"Face:" In CCN, the term face is a generalization of the concept of an interface. A face may be a connection to a network or directly to an application party. A face may be configured to send and receive broadcast or multicast packets on a particular network interface, or to send and receive packets using point-to-point addressing in the underlying transport, or using a tunnel (for example a TCP tunnel). A face may also be the connection to a single application process running on the same machine, via an encapsulation like UDP or an OS-specific inter-process communication path. All messages arrive through a face and are sent out through a face. In this disclosure, the term "neighbor" is interchangeable with the term "face," referring to incoming or outgoing interface of an Interest.

"Prefix:" In this disclosure, the term "prefix" can be used to refer to either a name of a specific content object or a name prefix for the content object.

"Anchor:" In this disclosure, the term "anchor" is used to refer to a router that advertises content. More specifically, a router (or a node) that advertises for some or all of the content corresponding to a prefix is referred to as an anchor of the prefix.

As mentioned before, an HSVLI indicates a piece of content, is hierarchically structured, and includes contiguous components ordered from a most general level to a most specific level. The length of a respective HSVLI is not fixed.

In content-centric networks, unlike a conventional IP network, a packet may be identified by an HSVLI. For example, “abcd/bob/papers/ccn/news” could be the name of the content and identifies the corresponding packet(s), i.e., the “news” article from the “ccn” collection of papers for a user named “Bob” at the organization named “ABCD.” To request a piece of content, a node expresses (e.g., broadcasts) an Interest in that content by the content’s name. An Interest in a piece of content can be a query for the content according to the content’s name or identifier. The content, if available in the network, is sent back from any node that stores the content to the requesting node. The routing infrastructure intelligently propagates the Interest to the prospective nodes that are likely to have the information and then carries available content back along the reverse path traversed by the Interest message. Essentially the Content Object follows the breadcrumbs left by the Interest message and thus reaches the requesting node.

FIG. 1 illustrates an exemplary architecture of a network, in accordance with an embodiment of the present invention. In this example, a network **180** comprises nodes **100-145**. Each node in the network is coupled to one or more other nodes. Network connection **185** is an example of such a connection. The network connection is shown as a solid line, but each line could also represent sub-networks or super-networks, which can couple one node to another node. Network **180** can be content-centric, a local network, a super-network, or a sub-network. Each of these networks can be interconnected so that a node in one network can reach a node in other networks. The network connection can be broadband, wireless, telephonic, satellite, or any type of network connection. A node can be a computer system, an end-point representing users, and/or a device that can generate Interest or originate content.

In accordance with an embodiment of the present invention, a consumer can generate an Interest for a piece of content and forward that Interest to a node in network **180**. The piece of content can be stored at a node in network **180** by a publisher or content provider, who can be located inside or outside the network. For example, in FIG. 1, the Interest in a piece of content originates at node **105**. If the content is not available at the node, the Interest flows to one or more nodes coupled to the first node. For example, in FIG. 1, the Interest flows (Interest flow **150**) to node **115**, which does not have the content available. Next, the Interest flows (Interest flow **155**) from node **115** to node **125**, which again does not have the content. The Interest then flows (Interest flow **160**) to node **130**, which does have the content available. The flow of the Content Object then retraces its path in reverse (content flows **165**, **170**, and **175**) until it reaches node **105**, where the content is delivered. Other processes such as authentication can be involved in the flow of content.

In network **180**, any number of intermediate nodes (nodes **100-145**) in the path between a content holder (node **130**) and the Interest generation node (node **105**) can participate in caching local copies of the content as it travels across the network. Caching reduces the network load for a second subscriber located in proximity to other subscribers by implicitly sharing access to the locally cached content.

#### A Link-State Content Routing (LCR) System

The operation of an LCR system assumes that: (a) each network node is assigned a name with a flat or hierarchical structure; (b) each piece of content is a named data object (NDO) that can be requested by name; (c) NDOs can be denoted using either flat or hierarchical naming (such as

HSVLI-based naming), and the same naming convention is used for the entire system; and (d) routers cache content opportunistically.

When hierarchical naming is used, there are different ways for routers to advertise their NDOs. For example, routers can be allowed to advertise a name prefix only if they have local copies of all NDOs associated with the name prefix. Alternatively, routers with subsets of the NDOs of the name prefix can be allowed to advertise the name prefix. In this disclosure, a router that advertises storing some or all of the content corresponding to a name or name prefix is called an anchor of the name or name prefix.

In order to implement LCR, routers in the ICN maintain a number of data structures, including a link cost table, a topology table ( $TT^i$ ), a routing table ( $RT^i$ ), and an anchor table ( $AT^i$ ).

The link cost table for a router  $i$  ( $LT^i$ ) lists the cost of the links from router  $i$  to each of its neighbors. In this disclosure, the link from router  $i$  to router  $k$  is denoted as  $(i,k)$  and the cost of the link is denoted as  $l_k^i$ . In some embodiments, the cost of the link is assumed to be a positive number, which can be a function of administrative constraints and performance measurements made by router  $i$  for the link.

The topology table ( $TT^i$ ) maintained by a router  $i$  states the link-state information reported or forwarded by each neighbor for each router and each known prefix. In some embodiments, the information stored in  $TT^i$  includes the links from  $i$  to each neighbor and to each locally available prefix, as well as the links to nodes or prefixes forwarded by neighbor routers. Note that the links to nodes are considered physical links, whereas the links to prefixes are considered virtual links. For example, a sub-table  $TT_m^i$  within  $TT^i$  includes links to nodes or prefixes forwarded by a neighbor router  $m$ .

FIG. 2 presents a diagram illustrating an exemplary topology table maintained at a router, in accordance with an embodiment of the present invention. In FIG. 2, a topology table **200** maintained by a router  $i$  includes two different types of link-state advertisement (LSA) entries. The first type of LSA entries are used to store information associated with physical links, and are indexed by the link identifiers. Such LSA entries can include the link identifiers, the cost function for the link, a sequence number, and a lifetime. For example, entry **202** represents an LSA stored in router  $i$  for link  $(u,v)$ , and includes the link identifier  $(u,v)$ , the cost of the link  $l_v^u$ , the most recent sequence number known by  $i$  that was created by  $u$  for the link  $sn_v^u$ , and the age (remaining lifetime) of the LSA  $t_v^u$ . In some embodiments, an LSA stored in router  $i$  for link  $(u,v)$  is denoted as  $l^i[(u,v),l_v^u,sn_v^u,t_v^u]$ .

On the other hand, the second type of LSA entries are used to store information associated with virtual links (prefixes), and are indexed by the prefixes. Such LSA entries can include the prefix, an anchor to the prefix, a sequence number, and a lifetime. For example, entry **204** represents an LSA stored in router  $i$  for a prefix  $j$  advertised by an anchor router  $k$ . The entry includes the name of the prefix  $j$ , the name of the router that act as an anchor of the prefix  $j$ , the most recent sequence number known by  $i$  that was created by  $k$  for the prefix  $sn_j^k$ , and the age (remaining lifetime) of the LSA  $t_j^k$ . In some embodiments, an LSA stored in router  $i$  for a prefix  $j$  advertised by an anchor router  $k$  is denoted as  $l^i[k,j,sn_j^k,t_j^k]$ .

Note that the age of an LSA is decremented monotonically while the LSA is stored in the topology table. An LSA, either for a physical link or a virtual link, will be deleted when its age reaches zero value (also known as being

expired). To reflect changes of the network topology or the location of content (the prefix), routers in the network send update messages periodically. For example, a router *i* may periodically send an update message to its neighbor *k*, with the update message containing changes made to its topology table  $TT^i$ .

The graph stored in  $TT^i$  is such that each physical link between two routers *u* and *v* corresponds to two directed links (*u,v*) and (*v,u*), and for each copy of a prefix *j* maintained at router *u* there is only a directed link (*u, j*). Hence, the shortest-path first algorithm or any other shortest-path algorithm can be executed in  $TT^i$  to compute shortest paths to a prefix or a physical router, with no path to any destination (prefix or physical router) traversing a prefix node as a relay along the path.

In some embodiments, router *i* updates its topology table  $TT^i$  when any adjacent link changes its status, new content becomes locally available, or an LSA is received. If router *i* receives a link LSA (an LSA associated with a physical link), such as  $l^i[(u,v),l_v^u,sn_v^u,t_v^u]$ , from a neighbor *k*, router *i* updates  $TT_m^i$  for each neighbor *m* only if the LSA is not an expired LSA, i.e., if  $t_v^u > 0$ ; and either (*u,v*) is not in  $TT_k^i$  or  $sn_v^u$  in the LSA is larger than the sequence number stored for (*u,v*) in  $TT_k^i$ . In other words, when router *i* receives a link LSA, it updates its topology table only if the link is a new link or the sequence number in the LSA is higher than the sequence number stored in the topology table for the same link, and if the LSA is not yet expired.

Similarly, if router *i* receives a prefix LSA (an LSA associated with a prefix), such as  $p^i[u,j,sn_j^u,t_j^u]$ , from a neighbor *k*, router *i* updates  $TT^i$  if  $t_j^u > 0$  in the LSA from *k*, and either (*u, j*) is not in  $TT^i$  or  $sn_j^u$  in the LSA is larger than the sequence number stored for (*u, j*) in  $TT^i$ . In other words, when router *i* receives a prefix LSA, it updates its topology table  $TT^i$  only if the virtual link is a new link or the sequence number in the LSA is higher than the sequence number stored in the topology table for the same virtual link, and if the LSA is not yet expired.

The routing table ( $RT^i$ ) maintained at router *i* stores routing information for each prefix known at router *i*. In some embodiments, a routing table may include a plurality of entries that are indexed by the prefix. FIG. 3 presents a diagram illustrating an exemplary routing table maintained at a router, in accordance with an embodiment of the present invention. In FIG. 3, a routing table 300 maintained by a router *i* includes a plurality of entries. Each entry includes the name of a prefix, a set of neighbors that are valid next hops to the prefix, and a neighbor that offers the shortest distance to the prefix. For example, entry 302 includes a prefix (*j*), a set of valid next-hop neighbors to *j* ( $S_j^i$ ), and the shortest-path neighbor to *j* ( $s_j \in S_j^i$ ).

The routing table can be updated by running the shortest-path first (SPF) algorithm. In some embodiments, router *i* computes the shortest paths to each prefix by running SPF with router *i* as the origin. The computed shortest distance from router *i* to each prefix *j* is denoted as  $d_j^i$ . Router *i* then runs SPF with each of its neighbors as the origin. The computed shortest distance via router *i*'s neighbor *k* to each prefix *j* is denoted as  $d_{jk}^i$ . In some embodiments, the computed shortest distances (including the one from router *i* and the ones from its neighbors) to each prefix are stored in the routing table.

The anchor table ( $AT^i$ ) maintained at router *i* stores the list of nearest anchor for each prefix known at router *i*. In some embodiments, the anchor table includes a plurality of entries that are indexed by the prefix. FIG. 4 presents a diagram illustrating an exemplary anchor table maintained at a router,

in accordance with an embodiment of the present invention. In FIG. 4, an anchor table 400 maintained by a router *i* includes a plurality of entries. Each entry includes the name of a prefix, a nearest anchor of the prefix (which is the router that has the shortest distance and the smallest identifier reporting the prefix), a sequence number assigned to the prefix by the nearest of the prefix; and a set of valid anchors reported by any next-hop neighbor. Note that, for each valid anchor, the anchor table stores a tuple that states the name of an anchor and the sequence number reported by that anchor. For example, entry 402 includes a prefix (*j*), a nearest anchor of *j* ( $a_j^i$ ), a sequence number assigned to *j* by anchor  $a_j^i$  ( $sn_j^i(a_j^i)$ ), and an anchor set ( $A_j^i$ ). Note that  $A_j^i$  stores a tuple  $[m,sn(m)] \in A_j^i$  for different valid anchor reported by any next-hop neighbor, with *m* being the name of a valid anchor, and  $sn(m)$  the sequence number reported by *m*. The sequence number can be used to avoid a routing-table loop when the routing table is updated. Note that only the anchors of prefixes are allowed to change the sequence numbers associated with the distances to the prefixes they announce.

The updating of the anchor table can be done as part of the updating of the routing table. More specifically, when SPF is run at router *i* with neighbor *k* as the origin and the shortest distance to prefix *j* ( $d_{jk}^i$ ) is obtained, router *i* stores the name of the neighbor, which is the router in the shortest path to prefix *j* with the link to prefix *j*, and the sequence number created by that router. After running SPF once for each neighbor of router *i* as the origin, router *i* obtains the anchor that should be reported by each neighbor for each prefix *j* according to the topology information stored in  $TT^i$ . As discussed previously, the set of anchors for prefix *j* reported by neighbors of router *i* is denoted as  $A_j^i$  and is stored in the anchor table  $AT^i$ .

It is desirable to have a routing table that does not include any loops. To do so, in some embodiments, a router *i* can select neighbors as next hops to a given prefix only if their distances to valid anchors of the prefix are shorter or are the same as the distance from router *i* to the prefix but have lexicographically smaller names. During operation, anchors send updates about locally available prefixes periodically and increment the sequence numbers they assign to prefixes, and routers update their routing table accordingly. Note that, to sufficiently ensure that no routing-table loops are ever created when routers change their next hops, a successor-set ordering condition (SOC) must be met. The SOC states that a neighbor *k* (which belongs to a set  $N^i$  containing router *i* and its neighbor routers) can become a member of  $S_j^i$  the valid next hop of router *i* to prefix *j*) only if the following two statements are true:

$$\forall [m,sn(m)] \in A_j^i (a_{jk}^i \neq m \vee sn_{jk}^i \geq sn(m)); \text{ and} \quad \text{Statement (1):}$$

$$(d_j^i < \infty \wedge [d_{jk}^i < d_j^i \vee (d_{jk}^i = d_j^i \wedge |k| < |i|)]) \vee (d_j^i = \infty \wedge d_{jk}^i < d_j^i \wedge \forall v \in N^i - \{k\} ((d_{jk}^i + l_k^i < d_{jv}^i + l_v^i) \vee [d_{jk}^i + l_k^i = d_{jv}^i + l_v^i \wedge |k| < |v|])) \quad \text{Statement (2):}$$

Note that  $sn(m)$  denotes the sequence number assigned by an anchor *m* to prefix *j* in the set of anchors known to router *i* for prefix *j* ( $A_j^i$ ),  $a_{jk}^i$  denotes a nearest anchor to *j* reported by *k*,  $sn_{jk}^i$  denotes the sequence number for *j* assigned by  $a_{jk}^i$ , and  $|i|$  denotes the lexicographic value of a name *i*.

Statement (1) specifies that only those neighbors reporting the most recent sequence numbers from known anchors of prefix *j* can be considered next hops. Statement (2) indicates that those neighbors are ordered lexicographically based on their distance to prefix *j* and their names. More specifically, if router *i* has a finite distance to prefix *j*, then it can select

neighbor  $k$  as a next hop to prefix  $j$  if either router  $k$  is closer to the prefix than router  $i$  or is at the same distance to the prefix but has a smaller lexicographic value than router  $i$  (as specified by the first line of statement (2)). On the other hand, if router  $i$  has an infinite distance to prefix  $j$ , then it can choose router  $k$  as a next hop to prefix  $j$  only if  $k$  reports the smallest finite distance to  $j$  among all neighbors, or it has the smallest identifier among those neighbors reporting the smallest finite distance to  $j$  (as specified by the last three lines of statement (2)).

FIG. 5 presents a diagram presenting an exemplary architecture of a router that implements LCR, in accordance with an embodiment of the present invention. In FIG. 5, LCR router 500 includes a topology table module 502, an anchor table module 504, a routing table module 506, an LSA-receiving module 508, an LSA-processing module 510, an LSA-forwarding module 512, and an LSA-generation module 514.

Topology table module 502 is responsible for maintaining and updating the topology table. As discussed previously, the topology table may include two types of LSA, the link LSAs and the prefix LSAs. In some embodiments, topology table module 502 updates the topology table when any adjacent link changes its status, new content becomes available, or when LSA-receiving module 508 receives an LSA. Anchor table module 504 is responsible for maintaining and updating the anchor table. In some embodiments, updating the anchor table involves running a shortest-path first (SPF) algorithm in the topology table in order to find the nearest anchor. In further embodiments, the nearest anchor is stored in the anchor table. In addition to the nearest anchor of a prefix, the anchor table also stores a set of anchors of the prefix reported by neighbor routers. Routing table module 506 is responsible for maintaining and updating the routing table, which specifies next-hop neighbors to each prefix and the shortest-path neighbor to the prefix. Similarly, the updating of the routing table involves running the SPF algorithm, not only using the router as the origin but also using the router's neighbors as origins. In some embodiments, to avoid routing-table loops, when the routing table is updated, a neighbor of the router needs to meet the SOC (both statements are true) in order to be considered a valid next hop to a particular prefix.

LSA-receiving module 508 is responsible for receiving LSAs from neighbors, LSA-processing module 510 is responsible for processing the received LSAs; and LSA-forwarding module 512 is responsible for forwarding LSAs. In some embodiments, LSA-processing module 510 examines the sequence number and the age of the received LSA. In some embodiments, LSA-processing module 510 may determine whether a received LSA is a link LSA or a prefix LSA. If the LSA received at router  $i$  from neighbor  $k$  is regarding a link  $(u,v)$ , it can be denoted as  $l^k[(u,v),l_v^k,sn_v^k,t_v^k]$ . Note that the link LSA may include a link identifier, a cost of the link, a sequence number created by router  $u$ , and the age of the LSA.

During operation, LSA-processing module 510 may further determine whether the link identified in the LSA has been listed in the topology table. If not, the link is a new link, and LSA-forwarding module 512 forwards the LSA. In a further embodiment, the LSA is flooded throughout the network. If the link is already listed in the topology table, LSA-processing module 510 determines whether the sequence number specified in the LSA is greater than the sequence number specified by the corresponding entry in the topology table. If so, and if the age of the LSA is larger than

0, LSA-forwarding module 512 forwards the received link LSA to other neighboring routers. Otherwise, router  $i$  may drop the LSA.

If the LSA received at router  $i$  from neighbor  $k$  is regarding a prefix  $j$ , denoted as  $p^k[u,j,sn_j^k,t_j^k]$ , LSA-processing module 510 will determine whether the shortest distance from router  $i$  to prefix  $j$  is through the path that includes virtual link  $(u,j)$ ; in other words, whether anchor  $u$  is the nearest anchor of prefix  $j$ . In some embodiments, a shortest-path first (SPF) algorithm is run in order to compute the shortest path to the prefix, which also updates the routing table and the anchor table. If anchor  $u$  is the closest anchor, and if the age of the LSA is larger than 0, LSA-forwarding module 512 forwards the prefix LSA to other neighboring routers. Otherwise, router  $i$  may drop the LSA (if its age expires) or stores the LSA in its topology table (if the sequence number included in the LSA is larger than the sequence number of the existing entry in the topology table for the same virtual link).

LSA-generation module 514 is responsible for generating LSAs. In some embodiments, LSA-generation module 514 generates link LSAs regarding physical links to its neighbors periodically and whenever there are status changes in the links. For example, a router  $i$  may generate a link LSA regarding a physical link  $(i,v)$  to its neighbor router  $v$ , denoted as  $l^i[(i,v),l_v^i,sn_v^i,t_v^i]$ . Note that the sequence number  $(sn_v^i)$  for the link LSA is incremented each time router  $i$  updates the LSA and the LSA states the maximum value for the age  $t_v^i$ . In some embodiments, LSA-generation module 514 generates a prefix LSA regarding a prefix periodically and whenever there is a status change in the locally available prefix. For example, a router  $i$  may generate an LSA regarding a prefix  $j$ , denoted as  $p^i[i,j,sn_j^i,t_j^i]$ . Note that the sequence number  $(sn_j^i)$  for the LSA is incremented each time router  $i$  updates the LSA and the LSA states the maximum value for the age  $t_j^i$ . The generated LSAs can be forwarded to neighboring routers by LSA-forwarding module 512. Also note that only the origins of LSAs can change the sequence numbers assigned to the LSAs.

#### An LCR Routing Example

When routing to the nearest replica of a prefix, the router implementing LCR uses information maintained in the topology table and the anchor table to compute the routing table, and sends updates to neighboring routers periodically, or whenever there is an update to its topology table. In some embodiments, the updates are in the form of LSAs. As discussed previously, during the operation, routers implementing LCR send out LSAs to each other to update their link state information. However, the dissemination of LSAs in LCR differs from traditional link-state routing (LSR) protocols. In traditional LSR protocols, all LSAs are flooded throughout the network; whereas in LCR only LSAs regarding physical links are flooded throughout the network, and LSAs regarding prefixes propagate through the network in such a way that each router reports only one anchor (often the shortest path anchor) for any known prefix.

FIG. 6 presents an LCR routing example, in accordance with an embodiment of the present invention. In FIG. 6, a network 600 includes a plurality of routers, each identified by its name, such as routers  $a, b, c, \dots, x, y,$  and  $Z$ . Note that network 600 does not include routers named  $g$  or  $j$ . In the example shown in FIG. 6, four routers (routers  $d, u, o,$  and  $r$ , which are shaded in the figure) serve as anchors for a particular prefix. Note that the darker the shade, the smaller the lexicographic value of the router. In other words, router  $d$  has the smallest lexicographic value, whereas router  $r$  has

the largest lexicographic value. Note that in FIG. 6 it is assumed that each link has a unit cost.

In FIG. 6, one or more tuples are listed in lexicographic order next to each router, with each tuple stating a distance to an anchor of the prefix and the identifier of that anchor. The first tuple (shown in darker font) in the list states the smallest distance to the prefix and the anchor with the smallest name among all anchors at that same distance. For example, three tuples are listed next to router q, stating that the distance from router q to anchor u is 1 (1 hop), the distance to anchor r is 2 (2 hops), and the distance to anchor d is 3 (3 hops). In other words, the smallest distance from router q to an anchor of the prefix is 1, and that smallest distance is to anchor u. On the other hand, there are two tuples listed next to router h, stating that the distance from router h to anchor d is 2 (2 hops), and the distance to anchor u is 2 (2 hops). Note that because router d has a smaller lexicographic value than router u, even though the distance is the same, router d is listed in the first tuple.

In some embodiments, updates from each router state only the preferred anchor (the first named anchor). In other words, each router pre-filters information it reports to its neighbors. For example, when the network changes resulting in router r becoming an anchor for the prefix, instead of reporting all anchors known at router e, an update from router e may only state router r as the anchor and distance as 1 to router r. In FIG. 6, each additional tuple next to a router, if any, states an alternative anchor for the prefix and the distance to it. These additional tuples are not reported by routers to their neighbors. In the example shown in FIG. 6, all routers are assumed to have received the most-recent sequence numbers from any of the anchors of the prefix.

The updates generated by an anchor propagate only as long as they provide routers with shorter paths to prefixes. In other words, an anchor updates status information associated with a local prefix by issuing an LSA, and by forwarding the LSA to its neighbors. The neighbors, however, forward such an LSA to their own neighbors only if such an LSA indicates a shorter path to the prefix. Hence, as the LSA is forwarded away from the originating anchor, it is less likely to provide a shorter path, given that there are other replicas in the network. In the example shown in FIG. 6, no routing update about the prefix propagates more than three hops, even though the network diameter is eight. In general, independently of how many anchors exist in a network for a given prefix, a router only has as many active anchors for a prefix as it has neighbors. This is the result of each router reporting only the best anchor it knows for each prefix. In FIG. 6, the arrowheads in the links between nodes indicate the router that is the next hop toward the prefix, and the links are identified by their shades and shapes. Arrows with dark solid lines indicate that those links point to router d, arrows with light solid lines indicate that those links point to router o, arrows with double lines indicate that those links point to router r, and arrows with dashed lines indicate that those links point to router u.

Note that even in this small network of just 24 routers, most routers have multiple paths to the prefix, with at least one being a shortest path. In FIG. 6, all links can be used to forward requests for content. One can see from FIG. 6 that none of the routers knows about all four of the anchors of the prefix (each of routers n, q, and e each knows three anchors). One can also see from FIG. 6 that traversing any possible directed path necessarily terminates at one of the anchors (anchor d, o, r, or u), without traversing a loop. It should be noted that, although the routes obtained with LCR are loop-free after the protocol finishes updating all routing

tables, temporary loops may take place while routing tables in the network are inconsistent.

Depending on the ICN architecture, LCR can be implemented using different name-based signaling approaches. When implementing LCR in an ICN network, one needs to decide the naming convention of the routers, the syntax of the update messages, and how to exchange the update messages among neighboring routers.

In some embodiments, the routers can be named using a hierarchical name space. For example, a particular router can have a hierarchical name, such as “/<network>/<site>/<router>,” and the LCR daemon running on the router can be named “/<network>/<site>/<router>/LCR.”

The semantics of the update process in LCR can include a router sending incremental updates on its topology table to all its neighbors. In some embodiments, such an update message is identified by the name of the router, the protocol (LCR), the type of message, and a sequence number incremented by the sending router. The update messages can be sent periodically and serve as an indication that the router is operational. The syntax of the update messages and exactly how messages are exchanged between routers depend on the basic signaling defined in the ICN architecture in which LCR operates. The signaling among routers can be receiver-initiated or sender-initiated.

With receiver-initiated signaling, data follow an Interest stated by the receiver. The LCR process in a router using NDN or CCN must periodically send a “Routing Interest” (RI) to elicit routing updates from its neighbors. In contrast to NLSR, the state of each neighbor router is different; hence, LCR signaling cannot be based on synchronization messages. In some embodiments, a router sends an RI to each neighbor to request routing information. The RI can have a format such as: “/<network>/<site>/<router>/LCR/update/seq\_no.” A router receiving the RI can respond with a Content Object corresponding to a “Routing Update” (RU) with the updates made to its routing table since the last RI.

Sender-initiated signaling can include each router sending RUs to all its neighbors, without having to be asked explicitly by any one neighbor. Implementing this signaling approach is more efficient but requires adding a “push” mechanism in the data plane of some ICN architectures or changing the semantics of Interests. For example, “Hello” messages stating the presence of a router can be sent as long-term RIs to which multiple RUs can be sent by the same router as needed. Alternatively, an RU can be sent as an Interest containing updates as attributes. The RIs or RUs sent from a router inform its neighbors that the router is alive.

In some embodiments, an LCR update in CCN or NDN is digitally signed by the anchor that originates the update, and the update states information that can be used in signature verification. Hence, LCR can attest that the LSA regarding the prefix of local content is valid. In addition, various security mechanisms can be implemented for LCR.

#### Overhead Comparison

This section compares the performance of LCR with other name-based content routing approaches based on the time, communication, and storage complexities in the control plane. In the following discussion, the number of routers in the network is denoted as N and the number of network links is denoted as E. Moreover, the number of different name prefixes available in the network is denoted as C, the average number of replicas for a given name prefix is R, the average number of neighbors per router is I, and the network diameter is d.

For simplicity, we assume that a separate control message is sent for any given LSA or distance update. In practice, multiple LSAs and distance updates can be aggregated to conserve bandwidth. In fact, aggregating distance updates for multiple prefixes is easier than aggregating LSAs from multiple sources. However, given that the maximum size of a control message is a constant value independent of the growth of N or C, this aggregation does not change the order size of the overhead incurred by the routing protocols.

The communication complexity (CC) of a routing protocol is the number of messages that must be transmitted successfully for each router to have correct routing information about all the C prefixes. The time complexity (TC) of a routing protocol is the maximum time needed for all routers to have correct routing information for all prefixes when all messages are transmitted successfully. The storage complexity (SC) of a routing protocol is the maximum number of entries in the routing table of an arbitrary router. Given that the difference in the number of messages exchanged between neighbors with receiver-initiated or sender-initiated signaling is independent of N, C and R, the results demonstrated here can apply to both types of signaling approaches.

As discussed in the background section, NLSR and OSPFN use a link-state routing (LSR) approach. With LSR, an LSA originated by a router regarding a link or a name prefix must be sent to all the other routers in the network. Moreover, a router must transmit an LSA for each adjacent link and each prefix that is stored locally, each LSA must be flooded in the network, and each router must store a record for each link and prefix copy in the network. Accordingly, the time, communication, and storage complexities of LSR are:

$$TC_{LSR}=O(d);$$

$$CC_{LSR}=O(E \times R \times C + I \times E \times N);$$

$$SC_{LSR}=O(R \times C + E)$$

Now consider routing approaches that rely on the Distributed Hash Table (DHT). The most efficient DHT scheme is a virtual DHT with one-hop routing, in which routers run the DHT locally and maintain routes to all routers in the network. The communication complexity associated with publishing a prefix in the DHT and associating r sites with the prefix (to support routing to any or all copies of the prefix) is  $O(d \times R \times C)$ , assuming no loops. The communication complexity of maintaining routes to all routers is  $O(I \times N \times E)$ , given that link-state routing is typically used. The fastest possible propagation of routes to all routers is order  $O(d)$ , and each router must store a record for as many prefixes as there are in the network. Therefore, the time, communication, and storage complexities of DHT are:

$$TC_{DHT}=O(d);$$

$$CC_{DHT}=O(d \times R \times C + I \times E \times N);$$

$$SC_{DHT}=O(C + E)$$

Now consider traditional distance-vector routing (DVR) approaches. Because DVR signaling can traverse long paths, and long-term loops and “counting to infinity” can occur, the basic distance-vector approach is known to have time complexity of  $O(N)$  and communication complexity of  $O(N^2)$ . Furthermore, each router must store and communicate distance information about all prefix replicas and destination nodes in the network. Accordingly, the time, communication, and storage complexities of DVR are:

$$TC_{DVR}=O(N);$$

$$CC_{DVR}=O(N^2 \times R \times C);$$

$$SC_{DVR}=O(R \times C + N)$$

As one can see, the complexities of DVR are much worse than the LSR and DHT approaches. This explains why name-based routing using distance vectors has not been considered in the past.

On the other hand, with the LCR approach, the information a router communicates for a given prefix is independent of the number of anchors for a given prefix or routers in the network. More specifically, in LCR a router communicates, for a given prefix, only its distance to the nearest anchor of the prefix, plus the anchor name and the latest sequence number created by that anchor. As the number of replicas increases, the distance from a router to the nearest replica of a prefix actually decreases, and it is always the case that the number of hops (x) from any router to the nearest replica of a prefix is at most d hops. Furthermore, as discussed previously, LCR does not incur any routing-table loops. This means that: (1) any routing information propagates as fast as the shortest path between its origin and the recipient; and (2) the number of messages required for all routers to have a correct distance to a given prefix is  $O(E)$ , regardless of the number of times the prefix is replicated (R). Given that there are C prefixes in the network, the complexity of LCR is:

$$TC_{LCR}=O(x);$$

$$CC_{LCR}=O(E \times C);$$

$$SC_{LCR}=O(I \times C + E)$$

The above analysis clearly shows that LCR has far smaller storage complexity than LSR or DVR, because an LCR router only needs to store one entry for a prefix, rather than one entry for each prefix replica, and does not need to store any topology information. As R becomes  $O(N)$ , LCR requires orders of magnitude less storage overhead than LSR or DVR, especially in large networks. Note that LCR is comparable to the DHT approach in terms of storage complexity in large networks. On the other hand, LCR has a much smaller time complexity and orders of magnitude smaller communication complexity when compared with the other approaches. More specifically, LCR allows routers to attain correct routing tables much faster than with DVR, LSR, and DHT, because routers only exchange updates about nearest prefix copies, rather than all copies, and such updates need to traverse paths that become much shorter than the network diameter as content replicas proliferate. Computer and Communication System

FIG. 7 illustrates an exemplary system for link-state content routing, in accordance with an embodiment of the present invention. A system 700 for link-state content routing comprises a processor 710, a memory 720, and a storage 730. Storage 730 typically stores instructions that can be loaded into memory 720 and executed by processor 710 to perform the methods mentioned above. In one embodiment, the instructions in storage 730 can implement a topology table module 732, an anchor table module 734, a routing table module 736, an LSA-receiving module 738, an LSA-processing module 740, an LSA-forwarding module 742, and an LSA-generation 744, all of which can be in communication with each other through various means.

In some embodiments, modules 732-744 can be partially or entirely implemented in hardware and can be part of processor 710. Further, in some embodiments, the system



may not include a separate processor and memory. Instead, in addition to performing their specific tasks, modules 732-744, either separately or in concert, may be part of general- or special-purpose computation engines.

Storage 730 stores programs to be executed by processor 710. Specifically, storage 730 stores a program that implements a system (application) for link-state content routing. During operation, the application program can be loaded from storage 730 into memory 720 and executed by processor 710. As a result, system 700 can perform the functions described above. System 700 can be coupled to an optional display 780 (which can be a touchscreen display), keyboard 760, and pointing device 770, and can also be coupled via one or more network interfaces to network 782.

The data structures and code described in this detailed description are typically stored on a computer-readable storage medium, which may be any device or medium that can store code and/or data for use by a computer system. The computer-readable storage medium includes, but is not limited to, volatile memory, non-volatile memory, magnetic and optical storage devices such as disk drives, magnetic tape, CDs (compact discs), DVDs (digital versatile discs or digital video discs), or other media capable of storing computer-readable media now known or later developed.

The methods and processes described in the detailed description section can be embodied as code and/or data, which can be stored in a computer-readable storage medium as described above. When a computer system reads and executes the code and/or data stored on the computer-readable storage medium, the computer system performs the methods and processes embodied as data structures and code and stored within the computer-readable storage medium.

Furthermore, methods and processes described herein can be included in hardware modules or apparatus. These modules or apparatus may include, but are not limited to, an application-specific integrated circuit (ASIC) chip, a field-programmable gate array (FPGA), a dedicated or shared processor that executes a particular software module or a piece of code at a particular time, and/or other programmable-logic devices now known or later developed. When the hardware modules or apparatus are activated, they perform the methods and processes included within them.

The above description is presented to enable any person skilled in the art to make and use the embodiments, and is provided in the context of a particular application and its requirements. Various modifications to the disclosed embodiments will be readily apparent to those skilled in the art, and the general principles defined herein may be applied to other embodiments and applications without departing from the spirit and scope of the present disclosure. Thus, the present invention is not limited to the embodiments shown, but is to be accorded the widest scope consistent with the principles and features disclosed herein.

What is claimed is:

1. A computer-executable method for updating link-status information associated with a prefix in an information-centric network (ICN), the method comprising:

receiving, by a first node in the ICN, a link-state advertisement (LSA) message from a neighbor node, wherein the LSA message specifies a prefix and an anchor node advertising the specified prefix;

identifying one or more valid next-hop neighbors to the prefix;

determining whether each of the one or more valid next-hop neighbors is closer to the anchor node than the first node, by using a shortest-path first (SPF) algorithm to compute a distance between the anchor node and

each of the one or more valid next-hop neighbors, to generate topology information;

determining, based on the topology information stored on the first node, whether a shortest-path condition is met, wherein determining whether the shortest-path condition is met includes computing, using the SPF algorithm, a shortest distance from the first node to the specified prefix;

in response to determining that a valid next-hop neighbor has a same distance to the anchor node as that of the first node, determining whether the valid next-hop neighbor has a smaller lexicographic value compared with that of the first node;

in response to the shortest-path condition being met, forwarding the received LSA message to other neighbors of the first node; and

in response to the shortest-path condition not being met, dropping the LSA message.

2. The method of claim 1, further comprising:

generating, by the first node, an LSA message reflecting a status change to a local prefix; and

forwarding the generated LSA message to neighbors of the first node.

3. The method of claim 1, wherein the topology information includes a routing table, the method further comprising: updating, by the first node, the routing table based on the received LSA message.

4. The method of claim 1, wherein the LSA message further includes a sequence number created by the anchor node, and wherein the sequence number increments each time the anchor node updates the LSA message for the specified prefix.

5. The method of claim 4, further comprising:

determining whether the sequence number included in the LSA message is greater than a prior sequence number stored in the topology information.

6. The method of claim 5, further comprising:

in response to determining that the sequence number included in the LSA message is not greater than a prior sequence number stored in the topology information, dropping the LSA message.

7. The method of claim 1, wherein the LSA message further includes a remaining lifetime value, and the method further comprises:

determining whether the remaining lifetime value is greater than zero; and

in response to determining that the remaining lifetime value is not greater than zero, dropping the LSA message.

8. A non-transitory computer-readable storage medium storing instructions that when executed by a computing device cause the computing device to perform a method for updating link-status information associated with a prefix in an information-centric network (ICN), the method comprising:

receiving, by a first node in the ICN, a link-state advertisement (LSA) message from a neighbor node, wherein the LSA message specifies a prefix and an anchor node advertising the specified prefix;

identifying one or more valid next-hop neighbors to the prefix;

determining whether each of the one or more valid next-hop neighbors is closer to the anchor node than the first node, by using a shortest-path first (SPF) algorithm to compute a distance between the anchor node and each of the one or more valid next-hop neighbors, to generate topology information;

17

determining, based on the topology information stored on the first node, whether a shortest-path condition is met, wherein determining whether the shortest-path condition is met includes computing, using the SPF algorithm, a shortest distance from the first node to the specified prefix;

in response to determining that a valid next-hop neighbor has a same distance to the anchor node as that of the first node, determining whether the valid next-hop neighbor has a smaller lexicographic value compared with that of the first node;

in response to the shortest-path condition being met, forwarding the received LSA message to other neighbors of the first node; and

in response to the shortest-path condition not being met, dropping the LSA message.

9. The non-transitory computer-readable storage medium of claim 8, wherein the method further comprises:

generating, by the first node, an LSA message reflecting a status change to a local prefix; and

forwarding the generated LSA message to neighbors of the first node.

10. The non-transitory computer-readable storage medium of claim 8, wherein the topology information includes a routing table, and wherein the method further comprises updating, by the first node, the routing table based on the received LSA message.

11. The non-transitory computer-readable storage medium of claim 8, wherein the LSA message further includes a sequence number created by the anchor node, and wherein the sequence number increments each time the anchor node updates the LSA message for the specified prefix.

12. The non-transitory computer-readable storage medium of claim 11, wherein the method further comprises: determining whether the sequence number included in the LSA message is greater than a prior sequence number stored in the topology information.

13. The non-transitory computer-readable storage medium of claim 12, wherein the method further comprises: in response to determining that the sequence number included in the LSA message is not greater than a prior sequence number stored in the topology information, dropping the LSA message.

14. The non-transitory computer-readable storage medium of claim 8, wherein the LSA message further includes a remaining lifetime value, and the method further comprises:

determining whether the remaining lifetime value is greater than zero; and

in response to determining that the remaining lifetime value is not greater than zero, dropping the LSA message.

15. A computer system for updating link-status information associated with a prefix in an information-centric network (ICN), the system comprising:

18

a processor; and

a storage device coupled to the processor and storing instructions which when executed by the processor cause the processor to perform a method, the method comprising:

receiving, by a first node in the ICN, a link-state advertisement (LSA) message from a neighbor node, wherein the LSA message specifies a prefix and an anchor node advertising the specified prefix;

identifying one or more valid next-hop neighbors to the prefix;

determining whether each of the one or more valid next-hop neighbors is closer to the anchor node than the first node, by using a shortest-path first (SPF) algorithm to compute a distance between the anchor node and each of the one or more valid next-hop neighbors, to generate topology information;

determining, based on the topology information stored on the first node, whether a shortest-path condition is met, wherein determining whether the shortest-path condition is met includes computing, using the SPF algorithm, a shortest distance from the first node to the specified prefix;

in response to determining that a valid next-hop neighbor has a same distance to the anchor node as that of the first node, determining whether the valid next-hop neighbor has a smaller lexicographic value compared with that of the first node;

in response to the shortest-path condition being met, forwarding the received LSA message to other neighbors of the first node, and

in response to the shortest-path condition not being met, dropping the LSA message.

16. The system of claim 15, wherein the method further comprises:

generating, by the first node, an LSA message reflecting a status change to a local prefix; and

forwarding the generated LSA message to neighbors of the first node.

17. The system of claim 15, wherein the topology information includes a routing table, and wherein the method further comprises updating, by the first node, the routing table based on the received LSA message.

18. The system of claim 15, wherein the LSA message further includes a sequence number created by the anchor node, and wherein the sequence number increments each time the anchor node updates the LSA message for the specified prefix.

19. The system of claim 18, wherein the method further comprises:

determining whether the sequence number included in the LSA message is greater than a prior sequence number stored in the topology information.

20. The system of claim 19, wherein the method further comprises:

in response to determining that the sequence number included in the LSA message is not greater than a prior sequence number stored in the topology information, dropping the LSA message.

\* \* \* \* \*