

Systematics and Evaluation of Meteorite Classification

Michael K. Weisberg

*Kingsborough Community College of the City University of New York
and American Museum of Natural History*

Timothy J. McCoy

Smithsonian Institution

Alexander N. Krot

University of Hawai'i at Manoa

Classification of meteorites is largely based on their mineralogical and petrographic characteristics and their whole-rock chemical and O-isotopic compositions. According to the currently used classification scheme, meteorites are divided into chondrites, primitive achondrites, and achondrites. There are 15 chondrite groups, including 8 carbonaceous (CI, CM, CO, CV, CK, CR, CH, CB), 3 ordinary (H, L, LL), 2 enstatite (EH, EL), and R and K chondrites. Several chondrites cannot be assigned to the existing groups and may represent the first members of new groups. Some groups are subdivided into subgroups, which may have resulted from asteroidal processing of a single group of meteorites. Each chondrite group is considered to have sampled a separate parent body. Some chondrite groups and ungrouped chondrites show chemical and mineralogical similarities and are grouped together into clans. The significance of this higher order of classification remains poorly understood. The primitive achondrites include ureilites, acapulcoites, lodranites, winonaites, and silicate inclusions in IAB and IIICD irons and probably represent recrystallization or residues from a low-degree partial melting of chondritic materials. The genetic relationship between primitive achondrites and the existing groups of chondritic meteorites remains controversial. Achondrites resulted from a high degree of melting of chondrites and include asteroidal (anrites, aubrites, howardites-diogenites-eucrites, mesosiderites, 3 groups of pallasites, 15 groups of irons plus many ungrouped irons) and planetary (martian, lunar) meteorites.

1. INTRODUCTION

Meteorite classification is the basic framework from which meteoriticists and cosmochemists work and communicate. It is a process designed to group similar meteorites together and evolves with the collection of new data, discovery of new types of meteorites, and new ideas about relationships between meteorites. Although classification does not necessarily need to imply genetic relationship, it has provoked questions about the processes that resulted in the similarities and differences among the meteorite groups and individual members within groups. Additionally, the relationship between primitive (chondrites) and differentiated (achondrites) meteorites and the parent bodies from which meteorites are derived is an important issue in meteorite study. Each chondrite group, for example, is often interpreted to represent materials from a single parent body. Differences in the characteristics among the chondrite groups have provided information on the types of primitive materials that were available during planetary accretion and the systematic geochemical trends of planetary bodies with their increasing distance from the Sun (e.g., *Wasson, 1985*). The wide variety of meteorite types has given rise to thoughts

on the number of planetary bodies (asteroids) represented in the meteorite record.

A variety of characteristics are used to classify meteorites (e.g., mineralogy, petrology, whole-rock chemistry, and O isotopes), but the groupings based on these data are not always consistent with each other. Additionally, a number of meteorites do not fit into the existing groups. In this chapter, we present the basic systematics of meteorite classification and describe meteorite classes, clans, groups, and subgroups to illustrate the diversity of solar system materials and the methods used to classify them. We also provide a critical evaluation of current meteorite classification. The reader is also directed to a number of contemporaneous writings on meteorite classification and properties that provide additional detail to the information and discussion offered here (e.g., *Brearley and Jones, 1998; Mittlefehldt et al., 1998; Krot et al., 2004; Mittlefehldt, 2004*).

2. HISTORICAL NOTE

The current classification scheme for meteorites had its beginnings in the 1860s with G. Rose's classification of the meteorite collection at the University Museum of Berlin and

Maskelyne's classification of the British Museum collection. Rose was the first to split stones into chondrites and nonchondrites. Maskelyne classified meteorites into siderites (irons), siderolites (stony irons), and aerolites (stones). This was followed by Tshermak's modification of the Rose classification in 1883 and Brezina's modification of the Tshermak-Rose classification scheme (see *Prior*, 1920). The first classification of meteorites based on chemical composition was by *Farrington* (1907), who chemically analyzed irons. Based on these earlier schemes, *Prior* (1920) developed a comprehensive meteorite classification scheme, introducing terms like mesosiderite and lodranite, that became the backbone of the current meteorite classification. *Prior*'s system was later modified by *Mason* (1967).

The meteorite classification system that is currently used and discussed in this chapter is broadly based on *Prior* (1920) and *Mason* (1967) and its modifications over the last four decades by a number of modern studies of the petrologic, bulk chemical, and O-isotopic characteristics of meteorites, infused with continual discovery of new meteorite samples.

3. CLASSIFICATION METHODS

3.1. Terminology and Nomenclature

Meteorites are classified in a variety of ways to communicate their different attributes, which have important implications. Meteorites are considered *falls* if they can be associated with an observed fall event and *finds* if they cannot be connected to a recorded fall event. This is an important distinction because finds, depending on the time they spent on Earth, are more prone to chemical interaction with the terrestrial environment. Therefore, the chemical trends they record need to be carefully considered. Most of the meteorites in our collections are finds and many of these are materials recovered from private and nationally organized search efforts in hot (Africa, Australia) and cold (Antarctica) deserts.

Meteorites are given names based on the location in which they are found (e.g., the Allende meteorite is a fall from Pueblito de Allende, Mexico). Meteorites from desert regions, such as Antarctica, are given names and numbers [e.g., Allan Hills (ALH) 84001 is a meteorite find that was collected in Allan Hills, Antarctica, during the 1984–1985 field season and was the first meteorite described in that field season].

The terms *stones*, *irons*, and *stony irons* are useful but this terminology is coarse and only serves as an initial description of the material. A more meaningful approach is division into *chondrites* (undifferentiated meteorites) and *achondrites* (differentiated meteorites) (Fig. 1). The chondrites are typically defined as meteorites that contain small (1–2 mm) spheres called chondrules (Fig. 2a,b). This is a misconception, since some lack chondrules. More properly, chondrites are meteorites that have solar-like compositions (minus the highly volatile elements) and are derived from

asteroids (and possibly comets) that did not experience planetary differentiation. The achondrites are igneous rock (melts, partial melts, melt residues) or breccias of igneous rock fragments from differentiated asteroids and planetary bodies (Mars, Moon). Some meteorites have achondritic (igneous or recrystallized) textures (Plates 1 and 2), but retain a primitive chemical affinity to their chondritic precursors. They are referred to as *primitive achondrites* because they are nonchondritic, but are thought to be closer to their primitive chondritic parent than other achondrites.

A number of variations on classification have been presented over the years. Like any natural history discipline, meteorite taxonomy is an attempt to group objects of similar type. At the lowest level (e.g., objects so similar that they must have originated from common materials, processes, and locations), general agreement exists as to groupings of meteorites. Disagreements center on higher-order systems that attempt to relate disparate materials through common processes (e.g., melted vs. unmelted), nebular reservoirs (e.g., O-isotopic composition or oxidation state), or parent bodies. The terms used for meteorite classification have evolved over time but they have not always been rigorously and consistently applied. Furthermore, the classification of chondrites and achondrites evolved independently, producing terminology for classification of achondrites and primitive achondrites that differs from that of chondrites. *Wasson* (1985) divided meteorites into chondrites and differentiated meteorites, and subdivided the differentiated meteorites into achondrites, stony irons, and stones. *Krot et al.* (2004) recently divided meteorites into chondrites and nonchondrites and subdivided the nonchondrites into achondrites, primitive achondrites, stony irons, and irons. *Kallemeyn et al.* (1996) recognized problems in dividing chondrites into classes and in distinguishing between class and clan affiliations in chondrites. They divided chondrites into two major classes, which they called carbonaceous and noncarbonaceous “super clans.” The noncarbonaceous super clan included the O, R, and E chondrites. They then divided the super clans into clans.

The hierarchy of terms for chondrite classification used in this chapter include, in order, class, clan, group, and subgroup. A chondrite *class* consists of two or more groups sharing primary whole-rock chemical and O-isotopic properties (e.g., *Hutchison*, 2004). Chondrites within a class have broadly similar refractory lithophile-element abundances that are enriched, depleted, or equal to solar abundances (Fig. 3a,b), with CI chondrites defining our best estimate of solar composition (e.g., *Anders and Grevesse*, 1989), and their O-isotopic compositions plot in the same general region (above, on, or below the terrestrial fractionation line) on a three-isotope diagram (Plate 3a,b). The chondrites are divided into three major *classes* — *carbonaceous* (C), *ordinary* (O), and *enstatite* (E). The letter nomenclature is probably best since the terms “carbonaceous” and “ordinary” are historical terms that are not very meaningful. For example, “ordinary,” originally applied because these are the most common meteorites, is an unfortunate term that

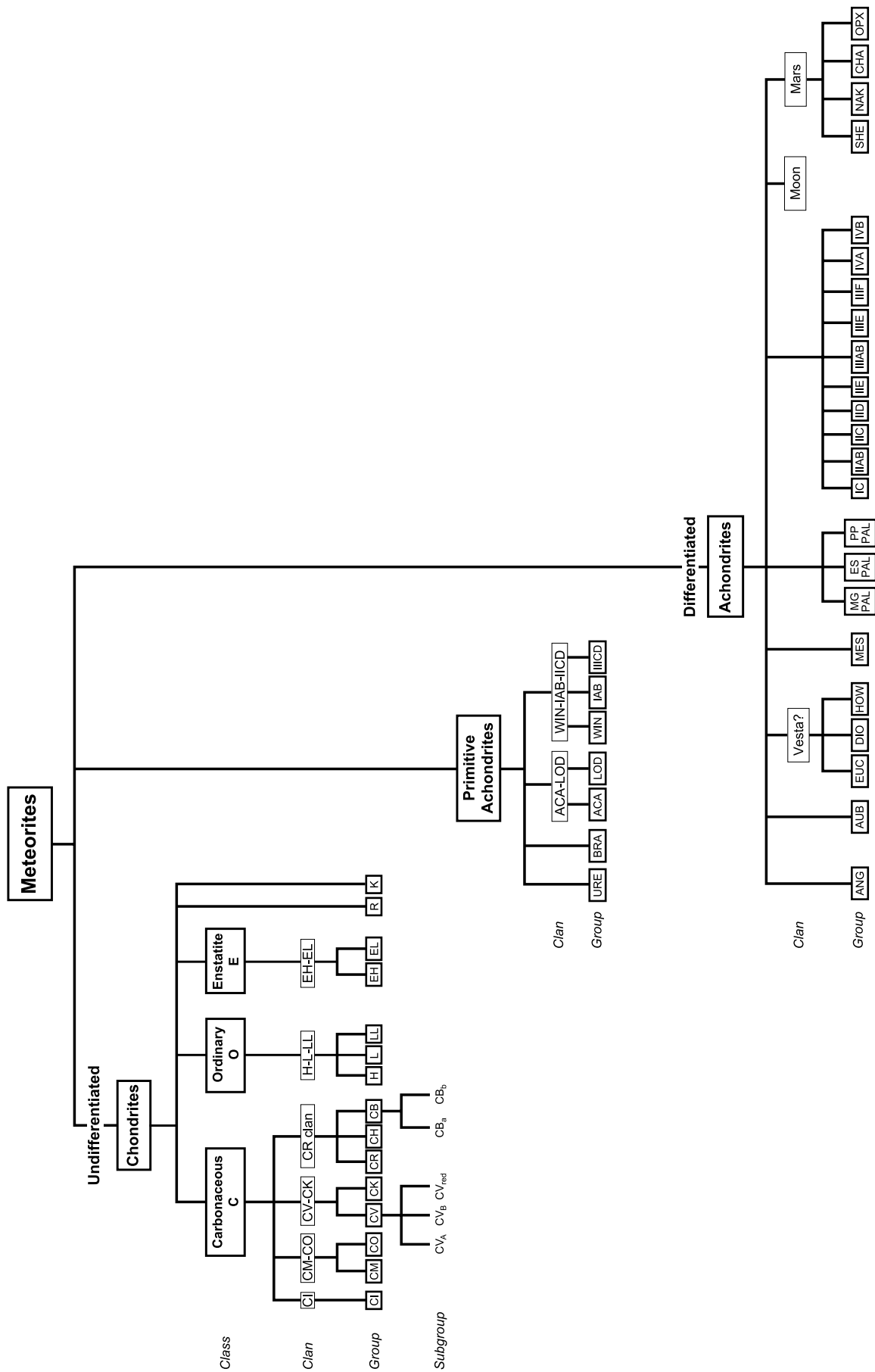

Fig. 1. Diagram expressing the systematics of meteorite classification and showing the major meteorite divisions, classes, clans, and groups and relationships among meteorite groups. URE — ureilite, ACA — acapulcoite, LOD — lodranite, ANG — angrite, AUB — aubrite, BRA — brachinite, WIN — winonaite, HED — howardite-eucrite-diogenite, MES — mesosiderite, MG PAL — main-group pallasite, ES PAL — Eagle Station pallasite, PP PAL — pyroxene pallasite, SHE — shergottite, NAK — nakhlite, CHA — chassignite, OPX — orthopyroxenite.

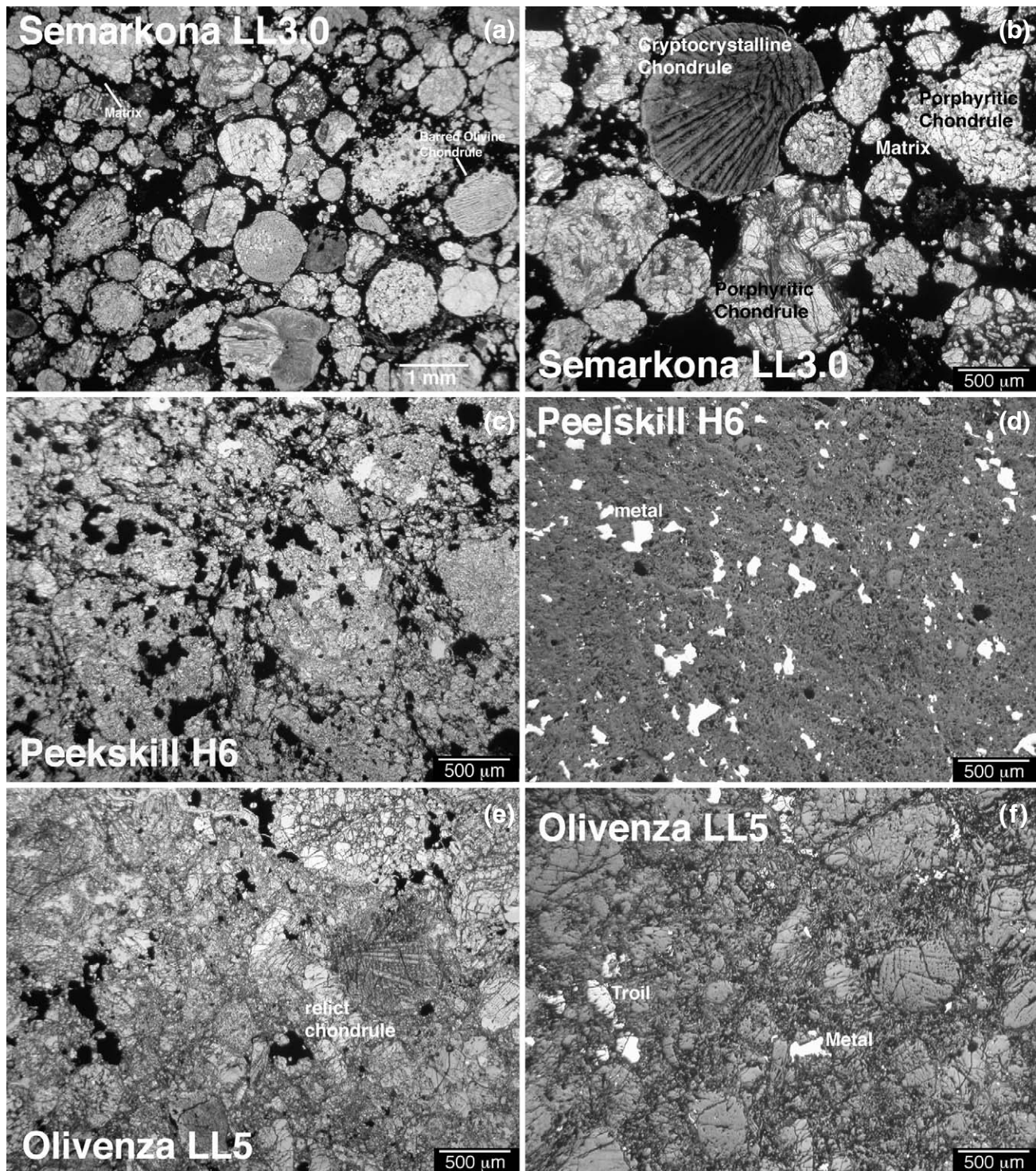

Fig. 2. Thin section, plane-polarized light (PL) and reflected light (RF) photomicrographs of representative examples of chondrites showing petrographic variations among chondrite groups. **(a)** The Semarkona L3.0 ordinary chondrite in PL showing a high density of chondrules with different textures (textural types) including barred and porphyritic chondrules, surrounded by opaque matrix. **(b)** The Semarkona chondrite in PL showing a large indented cryptocrystalline chondrule, porphyritic chondrules, and matrix. **(c)** The Peekskill H6 chondrite in PL showing a recrystallized ordinary chondrite in which the primary texture has been essentially destroyed and chondrule boundaries are not easily discernable. **(d)** Peekskill shown in RF showing about 7% metal. **(e)** The Olivenza LL5 ordinary chondrite in PL showing the texture of a recrystallized LL chondrite in which some relict chondrule are discernable, but chondrule boundaries are not as sharp as in Semarkona [(a),(b)]. **(f)** Olivenza in RF showing a lower abundance of metal (~2 vol%) than in the Peekskill H6 chondrite.

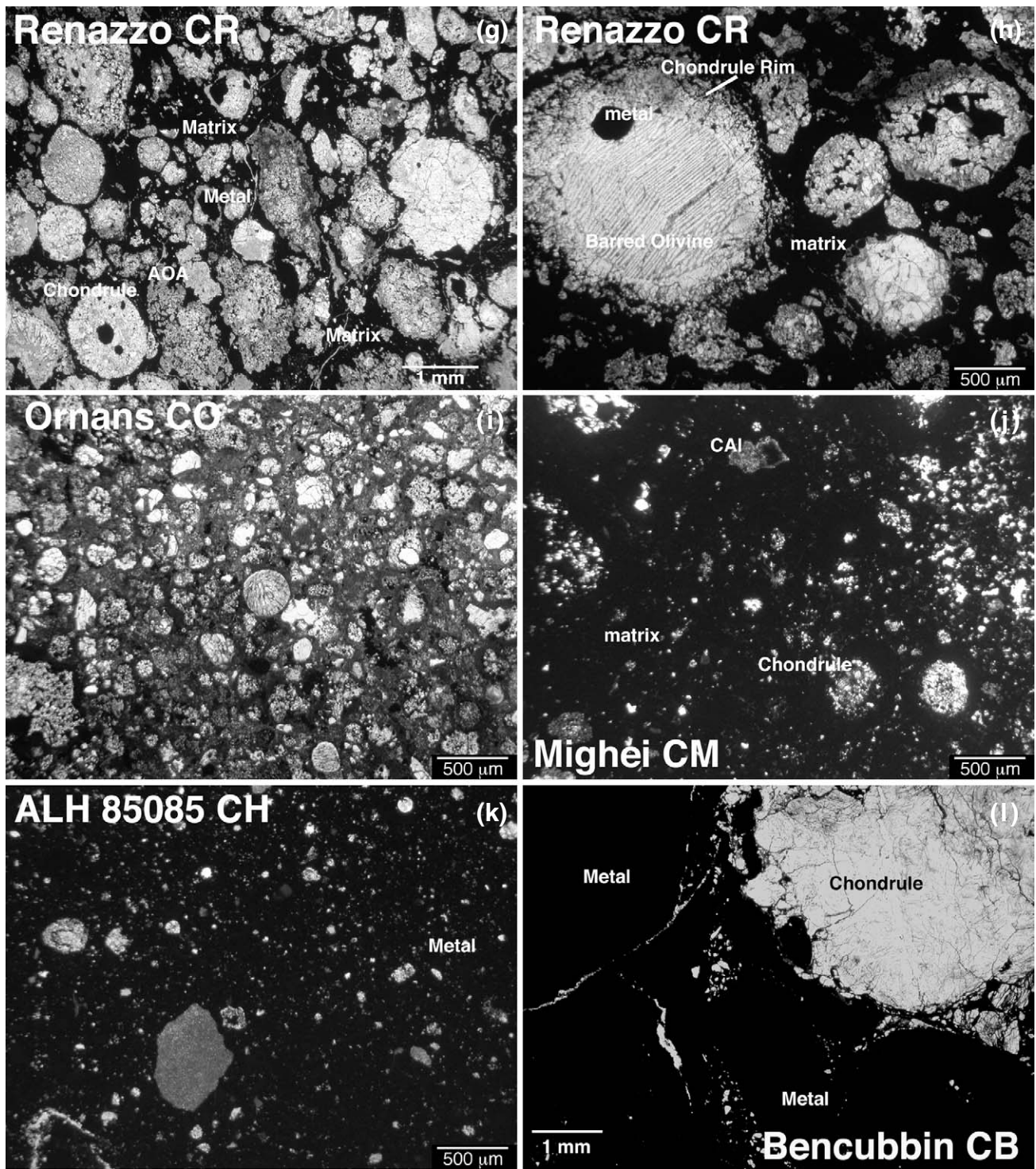

Fig. 2. (continued). (g) The Renazzo CR carbonaceous chondrite showing chondrules, opaque matrix, an amoeboid olivine aggregate (AOA) and a variety of other irregular-shaped objects. (h) Renazzo PL image showing a large (2 mm) barred olivine chondrule containing a metal bleb and a silicate rim. (i) The Ornans CO chondrite in PL showing the small (~200 μm) chondrules typical of CO chondrites and about 30% matrix. (j) PL photo of the Mighei CM chondrite showing the very high matrix abundance (up to 70 vol%) and small chondrules (100–200 μm) typical of CM chondrites. (k) The ALH 85085 CH chondrite in PL showing its microchondrules (most less than 100 μm in diameter) and fragments surrounded by Fe,Ni metal (~20 vol%). Most of the opaque areas are metal. (l) The Bencubbin CB chondrite in PL showing a large chondrule that is near 1 cm in diameter and opaque large Fe,Ni metal spheres.

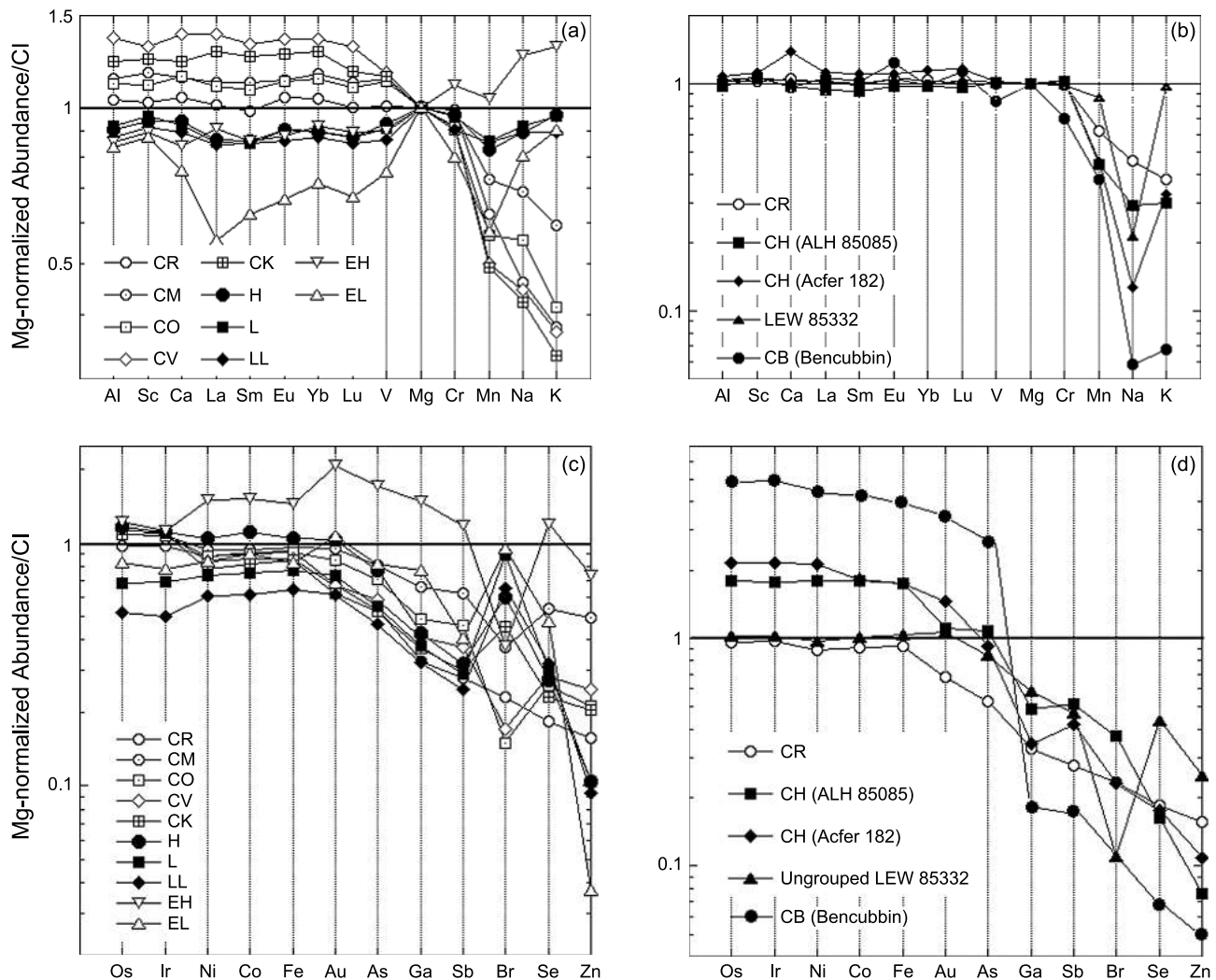

Fig. 3. “Spider diagram” showing the chemical differences among the various chondrite groups. Shown in this diagram are average whole-chondrite lithophile-element abundances in (a) various chondrite groups and (b) chondrite groups in the CR clan and siderophile-element abundances in (c) various chondrite groups and (d) chondrite groups in the CR clan. All data are normalized to Mg and CI chondrites. Elements are arranged according to their volatility. Data are from *Kallemeyn and Wasson* (1981, 1982, 1985), *Kallemeyn et al.* (1978, 1989, 1991, 1994, 1996), *Sears et al.* (1982), and *Wasson and Kallemeyn* (1988).

understates their importance; “carbonaceous” is essentially a misnomer since the carbon content of some C chondrites is very low.

The term *clan* is relatively new in chondrite classification and is used as a higher order of classification than group, but less inclusive than class. It was originally defined to encompass chondrites that have chemical, mineralogical, and isotopic similarities and were thought to have formed in the same local region of the solar nebula, i.e., in a narrow range of heliocentric distances (*Kallemeyn and Wasson*, 1981; *Kallemeyn et al.*, 1996). *Weisberg et al.* (1995a) used the term clan for a limited number of chondrites within a class that have chemical, mineralogical, and isotopic similarities suggesting a petrogenetic kinship, but have petrologic and/or bulk chemical characteristics that preclude a group relationship. A clan consists of chondrite

groups that may have closely similar refractory lithophile-element abundances (Fig. 3b), plot on the same O-isotopic mixing line (Plate 3a,b), share an isotopic anomaly, or have some similarities in petrologic characteristics (e.g., chondricle size or primary mineral compositions). Four C-chondrite clans have been recognized: the CR clan, which includes the CR, CH, CB, and ungrouped chondrite Lewis Cliff (LEW) 85332; the CM-CO clan; the CV-CK clan; and the CI clan (*Weisberg et al.*, 1995a; *Kallemeyn et al.*, 1996). The significance of chondrite clans is not well understood and requires further research and evaluation. They may represent materials from the same local nebular reservoir that were sorted according to size, or they may represent materials that experienced different secondary histories such as brecciation, impact events, oxidation or reduction, and/or hydrothermal alteration.

Kallemeyn et al. (1996) questioned the usefulness of dividing chondrites into the C, O, and E classes. The H, L, and LL groups overlap in O-isotopic compositions and petrologic characteristics, indicating that they are closely related at the *clan* level. The same is true for EH and EL chondrite groups. As shown in Fig. 1, the O and E chondrite classes consist of only one clan.

Group is arguably the most basic and significant unit used in meteorite taxonomy. Group is commonly interpreted to indicate that the meteorites are from the same parent body. The term *group* is defined as a minimum of five unpaired chondrites of closely similar petrologic (chondrule size, modal abundances, and mineral compositions), whole-rock chemical and O-isotopic characteristics (Table 1, Fig. 3, Plate 3). Groups within the C, O, and E chondrite classes are each named differently, due to historical practice. Groups within the C-chondrite class are designated with the letter C and a second letter that is usually the first initial of the type specimen for that group. Eight C-chondrite groups are currently recognized. These include CI (Ivuna-like), CM (Mighei-like), CO (Ornans-like), CV (Vigarano-like), CK (Karoonda-like), CR (Renazzo-like), CB (Bencubbin-like), and CH (high Fe; ALH 85085-like). Groups within the O-chondrite class are named H, L, and LL based on the abundance of Fe and the ratio of metallic Fe (Fe⁰) to oxidized Fe (FeO): H chondrites have the highest Fe and highest Fe⁰/FeO ratios (H, 0.58; L, 0.29; LL, 0.11) among O chondrites and LL chondrites the lowest. In the equilibrated O chondrites (petrologic types 4–6), this is also reflected in their olivine [(in mol% Fa): H, 16–20; L, 23–26; LL, 27–32] and low-Ca pyroxene compositions. Based on mineralogy and bulk chemistry, the E chondrites are divided into EH (high Fe) and EL (low Fe) groups. The R (Rumurutti-like) chondrites have whole-chondrite and O-isotopic characteristics that are consistent with their affiliation to the O-chondrite class. However, their O-isotopic compositions plot considerably above the ordinary chondrites on the three-isotope diagram (Plate 3a,b), and therefore may be a separate class or O-chondrite clan.

For cases in which there are less than five members, the term *grouplet* has been applied. The K (Kakangari-like) meteorites may be the most significant grouplet, for they fall outside the properties of the C, O, and E chondrite classes. They have refractory-lithophile-element abundances closer to the O chondrites and O-isotopic compositions that plot below the terrestrial fractionation line, like the C chondrites (Plate 3).

Systematic petrologic differences have been recognized in members of some chondrite groups, which led to division of these groups into *subgroups*. For example, the CV chondrites can be divided into the oxidized and reduced subgroups, based on matrix/chondrule ratios, metal/magnetite ratios, and Ni content of metal and sulfides.

Some chondrites are mineralogically and/or chemically unique and defy classification into the existing chondrite groups; these are commonly called *ungrouped* chondrites. Among the most significant of these are Acfer 094, which appears to have largely escaped parent-body processing, and

the unusual breccia Kaidun, which contains clasts of a variety of chondrite classes mixed on a millimeter scale. Meteorites within a group that have an atypical feature are often referred to *anomalous*.

The primitive achondrites have textures (Plate 1) suggesting that they were molten, partially molten, melt residues, or extensively recrystallized, but have a petrologic characteristic, whole-rock chemical compositions, or O-isotopic compositions that indicate a close affinity to the chondrites from which they formed (e.g., Prinz et al., 1983) (see the discussions of each primitive achondrite group below). The nomenclature of primitive achondrites tends to follow the terminology first established by Rose for achondrites, applying the “-ite” suffix to a particularly well-known or well-characterized member of the groups (e.g., acapulcoites for Acapulco), although it can also include the terminology of iron meteorites. The emergence of primitive achondrites as a branch in the tree of classification is one of the major classification developments in the past several years. Although a useful new branch of the classification tree, the term “primitive achondrite” suffers from a lack of concise definition and consistent application. The definition of Prinz et al. (1983) is useful for recognizing primitive achondrites. We suggest that primitive achondrites are generally meteorites that exceeded their solidus temperature on the parent body — thus experiencing partial melting — but did not crystallize from a melt. Or, if they were molten, they are derived from parent bodies in which planetary differentiation did not achieve isotopic equilibrium. For the classic core groups of the primitive achondrites (acapulcoites, lodranites, winonaites, silicate-bearing IAB and IIICD irons), evidence as residues of partial melting is clear and classification as primitive achondrites is relatively consistent. It is noted, however, that the definition separates residues (e.g., lodranites) from partial melts (e.g., eucrites), even though both may have formed as a result of partial melting at similar parent-body temperatures, and could obscure relationships between future recoveries of basalts and residues from a common parent body. For other groups, the criterion of not crystallizing from a melt remains contentious. Scientific debate continues about the origin of ureilites and brachinites as residues or cumulates. In this chapter, we argue that brachinites and ureilites are properly included as primitive achondrites based on their whole chemical or O-isotopic compositions.

Achondrites include irons, stony irons, and stones that are from differentiated asteroids, Mars, and the Moon. Historically the term achondrite referred to stony meteorites only and irons and stony irons have been considered separately. However, most iron meteorites are thought to be the cores of differentiated asteroids; some stony irons have been interpreted to be mixtures of core and mantle materials, core and crustal materials, or products of impact from differentiated asteroids. Therefore, they are considered here as achondrites. The hierarchical terms (class, clan) used for chondrites have not been applied rigorously or systematically to achondrites. To help resolve this issue, we used the term *clan* for achondrites and primitive achondrites as defined above for the chondrites (Fig. 1). The term *petrogenetic as-*

TABLE 1. Average petrologic characteristics of the major chondrite groups.

	CI	CM	CO	CV	CK	CR	CH	CB	H	L	LL	EH	EL	R	K
Chondrule abundance (vol%)*	≪1	20 [†]	48	45	45	50–60	70	20–40	60–80	60–80	60–80	60–80	60–80	>40	27
Matrix abundance (vol%)	>99	70 [†]	34	40	40	30–50	5	≪1	10–15	10–15	10–15	2–15 [‡]	2–15 [‡]	36	73
CAI – AOA abundance (vol%)	≪1	5	13	10	10	0.5	0.1	≪1	≪1	≪1	≪1	≪1	≪1	0	≪1
Metal abundance (vol%)	0	0.1	1–5	0–5	0–5	5–8	20	60–80	8	4	2	10	10	0.1	7
Average chondrule diameter (mm)	NA	0.3	0.15	1.0	1.0	0.7	0.02	(0.2–1 cm)	0.3	0.7	0.9	0.2	0.6	0.4	0.6
Olivine composition (mol% Fa)	††	††	††	††	(≪1–47) [§]	1–3 [¶]	2 [¶]	(2–3) [§]	(16–20) [§]	(23–26) [§]	(27–32) [§]	0.4	0.4	38.0 ^{**}	2.2
					29–33	1–3 [¶]	2 [¶]	3 [¶]	19.3 ^{**}	25.2 ^{**}	31.3 ^{**}	0.4	0.4	38.0 ^{**}	2.2

* Chondrule abundance includes lithic and mineral fragments.

[†] Highly variable.

[‡] The amount of matrix, if any, is not well established in E chondrites.

[§] Range of compositions.

[¶] Mode.

** Data for equilibrated varieties.

†† Highly variable, unequilibrated.

NA = not applicable.

sociation has been used for achondrite groups with similar chemical and isotopic characteristics that suggest they are from the same or similar asteroids. As we discuss below, this term is vague and probably should be discarded. The term *group* has had a different application and significance for achondrites compared to its use for the chondrites. It is generally implied that members in a chondrite group are fragments of the same or similar asteroid. This is not the case within the achondrites. While some groups (e.g., howardites) fit the definition of having formed on a single parent body, other groups encompass materials that formed on multiple parent bodies. Pallasites, in particular, appear to have formed on multiple parent bodies, as evidenced by the main group, Eagle Station, and pyroxene pallasites and the ungrouped pallasite Milton. Brachinites may have formed on multiple parent bodies and aubrites include the anomalous aubrite Shallowater that likely requires a different parent body from other aubrites. Thus, terms like pallasite, mesosiderite, and brachinite are more like textural terms that describe meteorites that formed by a similar process, but are not necessarily from the same parent body. Similarly, meteorites thought to have formed on the same parent body (e.g., acapulcoites-lodranites; winonaites-IAB-IIICD irons; howardites-eucrites-diogenites; basaltic-anorthositic lunar meteorites; shergottites-nakhlites-chassignites-orthopyroxenites from Mars) sometimes occur within different groups. Thus, the term group may carry a very different connotation for achondrites than for chondrites. Clearly, it would be ideal to standardize the naming conventions, perhaps applying the same class-clan-group-subgroup-ungrouped nomenclature to achondrites, although the historical entrenchment of these terms would make acceptance of any new system very difficult. The naming of achondrite groups itself is historical and somewhat confusing, adding the “-ite” suffix to well-known meteorites (e.g., angrites for Angra dos Reis), early workers in meteoritics (e.g., howardites for early chemist Edmund Howard), and even Greek terms (e.g., eucrites from the Greek for “easily determinable” in reference to the coarse grains within these basalts).

The classification of irons is discussed later. The terms presented in Fig. 1 are the chemical classification of irons, which includes a roman numeral and a one- or two-letter designation. Currently, there are 13 recognized groups, although Wasson and Kallemeyn (2002) argued that IAB and IIICD form a single group termed the IAB complex. While the geochemical differences between the groups owe their existence to nebular processes, the geochemical trends within 10 of these groups are consistent with fractional crystallization, with each group forming in the core of a separate asteroid (Scott, 1972).

3.2. Primary Classification Parameters

The classification scheme outlined above is largely predicated on knowledge of a meteorite’s petrologic characteristics, which include its texture, mineralogy, and mineral compositions; whole-rock chemical composition; and

O-isotopic composition (Tables 1 and 2, Figs. 2 and 3, Plates 1–3). As we discuss below, the vast majority of meteorites are characterized based on their petrology alone, although knowledge of all three is a virtual prerequisite for defining a new group. Other characteristics can occasionally provide supporting data. Nitrogen and C abundances and isotopes, for example, have been used to distinguish between chondrite groups (e.g., Kung and Clayton, 1978; Kerridge, 1985). Similar cosmic-ray-exposure ages for meteorites that are petrologically, chemically, or isotopically similar can point to a single ejection event from a common parent body and strengthen evidence of a grouping and genetic linkage.

Among the three classification methods, whole-rock chemical composition has been in use the longest. This is due in large part to the ability of early workers to determine chemical composition, long before the polarizing microscope made mineral identification and separation practical. Chondrite compositions are usually expressed as Mg- or Si-normalized abundances relative to CI chondrites. One of the defining chemical characteristics of the chondrites is that their whole-rock chemical compositions are not fractionated relative to the solar photosphere, with the exception of the moderately volatile to highly volatile elements (Fig. 3). CI chondrites are considered the best match to solar abundances, whereas the other chondrite groups are defined by a narrow range of uniform enrichments or depletions in refractory elements and volatility controlled depletions in the moderately volatile lithophile and siderophile elements relative to CI chondrites (Fig. 3). Other bulk compositional criteria for resolving the chondrite groups involve plotting reduced Fe (metallic Fe and Fe as FeS) against oxidized Fe (Fe in silicate and oxide phases). Also used are compositional diagrams of elements of different volatility: e.g., Sb/Ni vs. Ir/Ni, Sc/Mg vs. Ir/Ni, and Al/Mn vs. Zn/Mn (e.g., Kallemeyn et al., 1996). Bulk chemical composition is less commonly used as a primary classification criteria for stony achondrites, although it has been used to discriminate different igneous trends in the eucrites. For iron meteorites, the trace elements Ga, Ge, Ir, and Ni provide the basis for classification into chemical groups (Fig. 4).

Petrologic examination, including both textural and mineralogical studies in the polarizing microscope and mineralogical and mineral chemical studies using the electron microprobe or scanning electron microscope, have largely supplanted bulk chemical studies as the primary tool for classification of most meteorites, in large part because of their simplicity. A basic distinction between the chondrites and achondrites is texture. Chondrites generally have characteristic aggregational textures that sharply distinguish them from the igneous or recrystallized textured achondrites (Fig. 2). Most meteorites have unique textural and mineralogical properties that allow their classification by petrologic thin section analysis. In chondrites, these properties include chondrule size, chondrule to matrix ratios, abundance of metal, and mineral compositions (Table 1, Fig. 2). For achondrites, characteristic textures (e.g., igneous vs.

TABLE 2. Average petrologic characteristics of the major (asteroidal) achondrite and primitive achondrite groups.

	URE	ACA	LOD	ANG	AUB	BRA	WIN	HED	MES	PAL
Texture	coarse, some mosaicized	fine	coarse	medium to coarse	coarse/ brecciated	equigranular, with triple junctions	fine to medium	fine to coarse equigranular brecciated	breccias/ impact melt	coarse
Olivine composition Fa (mol%)	2–26*	4–13	3–13	11–66 (La 0.1–48)	<0.1	30–35	1–8	27–44	8–37	8–30
Low-Ca pyroxene Fs (mol%)	13–25	1–9	1–9		0.1–1.2	trace	1–9	14–79	23–59	—
Ca-pyroxene Fs (mol%)	13–32	46–50	46–50	12–50	0–0.2	10–13	2–4			
Wo (mol%)	2–16	43–46	43–46	50–55	40–46	38.7–47 (up to 5% TiO ₂) (up to 12% Al ₂ O ₃)	44–45	—	—	—
Plagioclase An (mol%)	rare to absent	12–31	12–31	86–99.7	2–23	22–32	11–22	73–96	91–93	—
Metal	rare	present	present	rare	rare	minor [†]	present	rare	(stony-iron)	(stony-iron)
Other minerals present	augite graphite	troilite phosphates spinel graphite	troilite phosphates spinel graphite	spinel troilite phosphates oxides	variety of cubic sulfides	sulfide oxides	troilite daubreelite schreibersite graphite	pigeonite silica chromite	pigeonite silica phosphates	phosphates troilite

* Olivine has reduction rims with near-end-member compositions. La-Ca end member.

[†] Tafassasset is a metal-rich (8 vol%) brachinite.

URE = ureilites, ACA = acapulcoite, LOD = lodranite, ANG = angrites, AUB = aubrite, BRA = brachinite, WIN = winonaites, HED = howardite = eucrite = diogenite, MES = mesosiderite, PAL = pallasite.

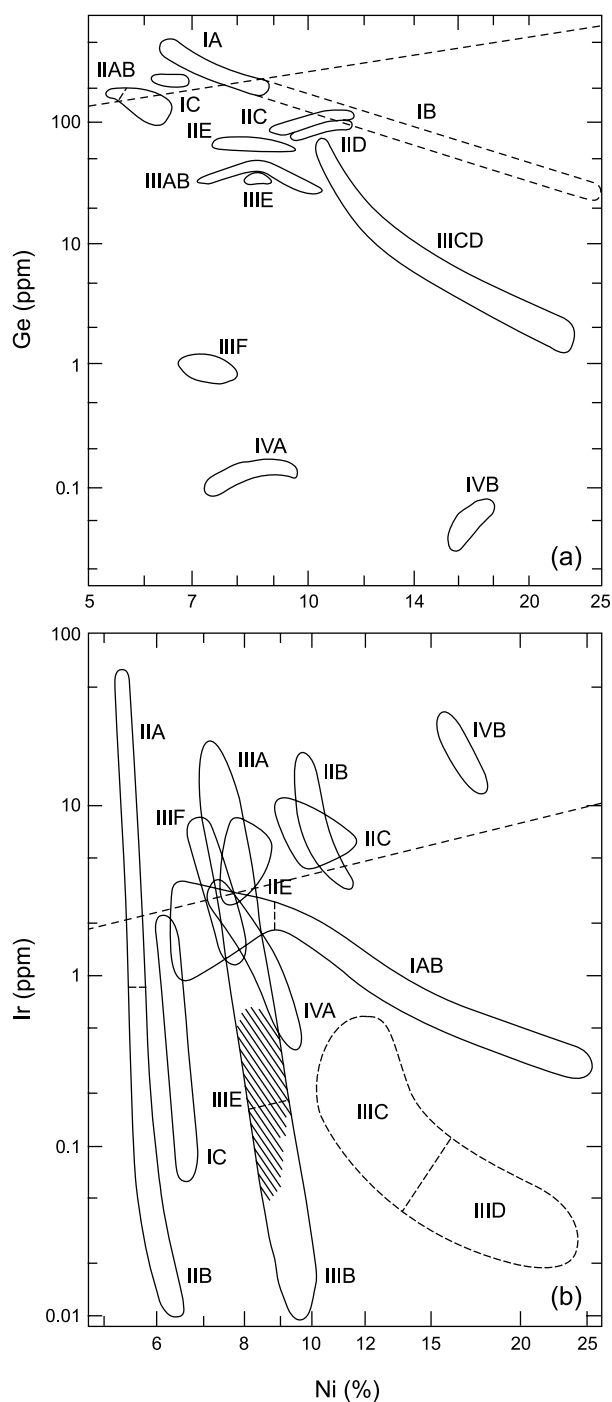

Fig. 4. Plots of (a) Ni vs. Ge and (b) Ni vs. Ir showing the fields for the 13 iron meteorite groups (from Scott and Wasson, 1975).

granoblastic), modal abundances of minerals, and mineral compositions are used to identify them by thin section examination (e.g., Table 2, Plates 1 and 2). As an example, eucrites are basalts that have igneous intergrowths dominated by plagioclase and clinopyroxene with an Fe/Mn ratio in the pyroxene of ~ 30 . In general, petrologic studies and whole-rock chemical compositions tend to mirror one another, as the chemical composition tends to reflect the

composition and abundance of the individual minerals and, at least in achondrites, the bulk chemical composition controls mineral crystallization.

Pioneered by R. Clayton and colleagues at the University of Chicago, the discovery that small anomalies in the abundance of the minor isotope ^{17}O could provide a unique fingerprint of nebular or parent-body origin opened a new way to determine relationships among meteorites not necessarily apparent from petrology or whole-rock chemical composition. Each meteorite group occupies a specific region on a three-isotope plot for O (Plate 3). Nominally anhydrous chondrites plot along lines of slope-1, suggesting that their O-isotopic trends result from mass-independent fractionation in the solar nebula. For example, the CV, CO, and CK chondrites plot along a slope-1 line commonly referred to as the C-chondrite anhydrous mineral (CCAM) mixing line. In contrast, hydrated chondrites (e.g., CM and CR chondrites) generally plot along shallower slopes (~ 0.7), indicative of modification by aqueous alteration. Like the highly differentiated and homogenized Earth, achondrites from largely molten bodies (e.g., Moon, Mars, Vesta) plot along slopes of 0.52, the result of mass fractionation imparted during melting. Some primitive achondrites (e.g., ureilites, acapulcoites-lodranites) exhibit greater deviation from this slope-0.52 line. Among these, the ureilites exhibit the most dramatic O-isotopic heterogeneity. Despite similar petrologic and bulk chemical characteristics and igneous textures suggesting a cumulate or partial melt residue origin, their whole-rock O-isotopic compositions plot along a mixing line that is an extension of the CCAM line (Plate 3), indicating that if ureilites are from a single asteroid, it was not internally equilibrated in terms of O isotopes during differentiation.

In the practical matter of actually placing a new meteorite within one of the classificational bins — or deciding that it is ungrouped or joins with others to form a new group — petrologic studies are the tool of choice. More than 98% of the world's known meteorites have been adequately classified from petrologic studies alone, although that number is dominated by equilibrated O chondrites from hot and cold deserts. Because many meteorite groups have characteristic textures and metal abundances (e.g., Fig. 2, Plates 1 and 2), a trained observer can make a good first estimate of classification with the unaided eye. Good examples include the unusual white fusion crust on aubrites or the presence of small, rare chondrules in black matrix of a CM chondrite. Petrologic studies typically involve preparation of a polished thin section to examine a variety of textural and mineralogical features, including the variety of minerals present and identifiable with the polarizing microscope, the presence or absence of chondrules, the texture, and mineral abundances. Although tentative classification can often be made by the trained observer in hand sample or thin section, mineral analyses are essential for definitive classification. Typically, olivine, pyroxene, and, sometimes, plagioclase are analyzed, since they are widespread in meteorites and have diagnostic mineral compositions between

TABLE 3. Summary of the criteria for classifying chondrites according to petrologic type, based on *Van Schmus and Wood (1967)*.

Criterion	1	2	3	4	5	6	7
Homogeneity of olivine compositions	—	>5% mean deviations		≤5%	Homogeneous		
Structural state of low-Ca pyroxene	—	Predominantly monoclinic		>20% monoclinic	≤20% monoclinic	Orthorhombic	
Feldspar	—	Minor primary grains		Secondary <2- μ m grains	Secondary 2-50- μ m grains	Secondary >50- μ m grains	
Chondrule glass	Altered or absent	Mostly altered, some preserved	Clear, isotropic	Devitrified	Absent		
Metal: Maximum Ni (wt%)	—	<20 taenite minor or absent	kamacite and taenite in exsolution relationship				
Sulfides: Mean Ni (wt%)	—	>0.5	<0.5				
Matrix	Fine grained opaque	Mostly fine-grained opaque	Opaque to transparent	Transparent, recrystallized			
Chondrule-matrix integration	No chondrules	Sharp chondrule boundaries	Some chondrules can be discerned, fewer sharp edges		Chondrules poorly delineated	Primary textures destroyed	
Carbon (wt%)	3-5	0.8-2.6	0.2-1	<0.2			
Water (wt%)	18-22	2-16	0.3-3	<1.5			

After *Van Schmus and Wood (1967)* with modifications by *Sears and Dodd (1988)*, *Brearley and Jones (1998)*, and this work.

the different groups. Mineral chemistries are typically determined with the electron microprobe or scanning electron microscope to determine mineral composition and degree of mineral heterogeneity. Among the more abundant meteorites from hot and cold deserts, older techniques, such as oil immersion analyses, are used to distinguish between critical ranges of mineral compositions and classify the abundant equilibrated O chondrites. In some cases, other minerals provide diagnostic compositions, such as the concentration of Si in the metal of E chondrites or the Fe/Mn ratio of pyroxene in lunar, martian, and eucritic basalts.

Petrologic studies alone have produced some spectacular misclassifications. For example, the basalt Elephant Moraine (EET) 87251 was originally thought to be a eucrite (asteroidal basalt) and the ALH 84001 pyroxenite was classified as a diogenite (asteroidal orthopyroxenite). Elephant Moraine 87251 is now known to be a lunar meteorite and ALH 84001 is martian. In the case of ALH 84001, this misclassification stemmed from a lack of appreciation of the petrologic diversity likely to be found on Mars. As a general rule, misclassifications are minimized if a group of competent workers with a range of specializations within the field are consulted about meteorites for which one or more petrologic features seem odd. In these cases, O-isotopic compositions tend to be sought. Chemical compositions are less commonly sought as a primary classificational tool, although they are essential for iron meteorites. It is important to emphasize that even some of the best-studied meteorites in the world cannot be confidently binned into the existing scheme, suggesting either transitional properties between groups or sampling of a previously unknown type of meteorite.

3.3. Secondary and Tertiary Properties

Chondrites are assigned a number according to petrologic type (e.g., *Van Schmus and Wood, 1967*; Table 3). Type 3.0 is thought to represent the most pristine materials, 3.1 to 6 indicate increasing degree of petrologic equilibration and recrystallization, and 2 to 1 represent increasing degree of hydrous alteration in chondrites. Type 7 has been used to indicate chondrites that have been completely recrystallized or melted, but some or most of these meteorites may be impact melted. Petrologic types can be assigned based on petrologic observation, mineral composition (Table 3), and thermoluminescence properties of the meteorite. However, the mineral criteria listed in Table 3 do not work equally well for all chondrite groups (*Huss et al., 2006*). For example, one of the major criteria used to distinguish between type 3 and 4 is heterogeneity of olivine composition. This is difficult to apply to E chondrites because olivine is low in abundance. Also, the amount of Fe in silicate is low due to the reducing conditions under which the meteorites formed and is not a reflection of the degree of metamorphic equilibration.

In some cases, the petrologic type is reflected in whole-rock O-isotopic composition; e.g., in equilibrated (type 4–

6) chondrites, whole-rock O-isotopic compositions become increasingly homogenous. The slope ~ 0.7 line of CM chondrites, most of which are (hydrated) petrologic type 2, on an O three-isotope plot has been attributed to closed-system hydration reactions with water that has heavier O than the silicates (*Clayton and Mayeda, 1999*).

Figure 5 shows the petrologic types that are represented in each of the chondrite groups. Some groups (e.g., H, L, LL, EH, EL) do not have heavily hydrated (petrologic types 2 and 1) members. Other groups (e.g., CI, CM, CR) lack less-altered (type 3) members. This is particularly unfortunate in the case of the CI chondrites, which chemically are among the most primitive solar system materials.

Thermoluminescence (TL) has been used to subdivide the petrologic type 3 chondrites into 3.0 to 3.9 subtypes (*Sears et al., 1980*). This has been largely applied to O chondrites. Thermoluminescence sensitivity is largely dependent on the degree of crystallization of the chondrule mesostasis. Thus, we can recognize meteorites such as Semarkona (LL3.0) and Krymka (LL3.1), which are interpreted to be examples of the most pristine O chondrites. The TL data are supported by the high degree of disequilibrium in the mineral assemblage of chondrules and matrix and the abundance of glassy mesostasis in the chondrules of the low petrologic type (<3.5) chondrites (*Huss et al., 2006*).

It can be argued that the current scheme for petrologic type needs extensive revision. For example, does it make sense to have a scheme where type 3 denotes the least-altered meteorites and alteration proceeds to lower and higher values depending on whether it is hydrous alteration or ther-

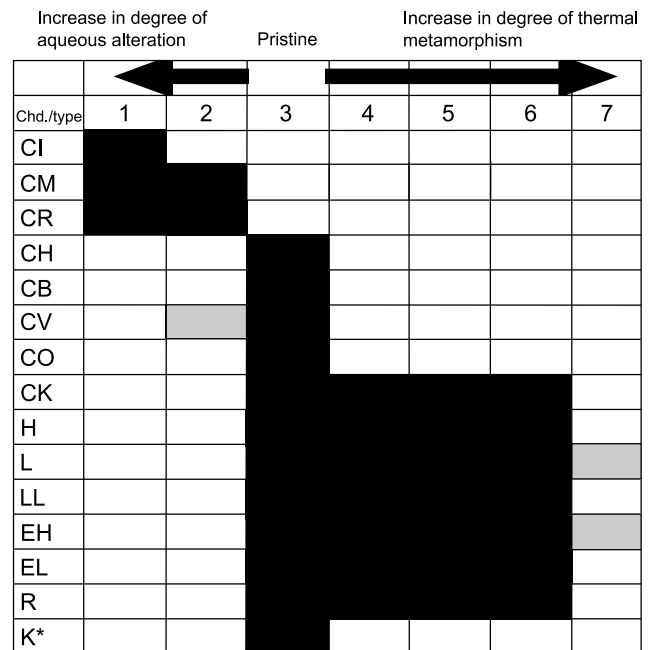

*Grouplet.

Chd. = chondrite group.

Fig. 5. Diagram showing the petrologic types for each chondrite group.

mal metamorphism? More importantly, there are meteorites that have been hydrously altered and have been later reheated during thermal metamorphism. There is no way to label such cases in the current scheme. One solution may be to have separate schemes for denoting degree of hydrous alteration and degree of metamorphism.

Chondrites are also assigned values that represent the degree of shock pressure that they experienced. These values range from S1 (unshocked, pressure <5 GPa) to S6 (very strongly shocked, pressures up to 90 GPa). The shock stages are assigned based on petrographic features of the silicate minerals olivine, pyroxene, and plagioclase and include undulatory extinction, fracturing, and mosaicism, as well as transformation of plagioclase into maskelynite (e.g., *Stöffler et al.*, 1991; *Rubin et al.*, 1997). Other indicators of high degrees of shock in chondrites include the presence of high-pressure minerals, such as majorite garnet and wadslyite, a high-pressure form of olivine (e.g., *Kimura et al.*, 2003). However, the degree of shock can vary within a meteorite on the scale of centimeters.

Finally, meteorites have been subjected to 4.5 b.y. of impact processing, producing myriad breccias. With rare exceptions, chondrite breccias are *genomict*, i.e., consist of clasts belonging to the same chondrite group. Relatively few chondrite breccias contain clasts belonging to different meteorite groups and are called *polymict*. This observation has led to the conclusion that each chondrite group represents a single parent body [see Table 1 in *Bischoff et al.* (2006) for nomenclature of chondrite breccias]. Some chondrites are termed genomict breccias (*Bischoff et al.*, 2006), indicating that they contain fragments of the same chondrite group, but different petrologic types. Many achondrites are brecciated. Most notable among these are the howardites, which are, by definition, breccias consisting of eucrite and diogenite components. It is interesting to note that no iron meteorites are true breccias (e.g., recemented fragments of previously formed and fragmented iron meteorites), perhaps pointing to the inability of impacts to relithify iron meteorite regolith.

4. MAJOR GROUPINGS AND THEIR SIGNIFICANCE

The chondrites are among the most primitive solar system materials available for laboratory study. They are composed of submillimeter- to centimeter-sized components, including chondrules, Ca-Al-rich inclusions (CAIs), amoeboid olivine aggregates (AOAs), Fe, Ni-metal, and fine-grained matrix (Fig. 2a–d). These components are thought to have formed as independent objects in the protoplanetary disk by high-temperature processes that included condensation and evaporation (e.g., *Ebel*, 2006; *Fedkin and Grossman*, 2006). As a result, chondritic components of primitive (unaltered and unmetamorphosed) chondrites preserved records of the physical-chemical properties of the protoplanetary disk region(s) where they formed, and are ground truth for astrophysical models of nebular evolution. Chondrules

are spherical to semispherical objects, generally composed of mafic minerals and interpreted to have formed as molten or partly melted droplets from transient heating event(s) in the solar nebula. Chondrule textures are illustrated in Fig. 2 and in Fig. 1 from *Lauretta et al.* (2006). Calcium-aluminum-rich inclusions and AOAs are irregular to spherical objects having primary minerals that are composed of more refractory elements than those in the chondrules. The mineralogy of CAIs is discussed by *Beckett et al.* (2006). Surrounding the chondrules and inclusions is a fine-grained (generally <5 μm) silicate-rich matrix. Chondrite matrix is a separate component, not simply composed of pulverized chondrules and CAIs, and its relationship to the chondrules and CAIs in a chondrite is not well understood. Chondrite matrix is discussed by *Krot et al.* (2006) and *Breareley* (2006). Additionally, chondrites contain small (<5–10 μm) presolar grains of diamond, silicon carbide, graphite, silicon nitride, and oxides (e.g., *Anders and Zinner*, 1993; *Bernatowicz and Zinner*, 1997).

The achondrites include meteorites from asteroids, Mars, and the Moon. Primitive achondrites may represent melts, partial melts, or melt residues from local heating events on planetary bodies during the earliest stages of differentiation or possibly from local impact events. We include ureilites, brachinites, acapulcoites, lodranites, winonaites, and IAB and IIICD irons as primitive achondrites. Below we illustrate important characteristics of some meteorite clans, groups, and subgroups and the data used to establish the groupings. Further discussions of achondrites are given by *McCoy et al.* (2006); see *Chabot and Haack* (2006) for a discussion of irons. The descriptions below are meant to give the reader an overview of some of the distinguishing characteristics of the variety of meteorites available for study.

5. PROPERTIES OF CHONDRITES

5.1. Carbonaceous (C) Chondrites

Carbonaceous chondrites are characterized by whole-chondrite (Mg-normalized) refractory-lithophile-element abundances $\geq 1\times$ CI (Fig. 3) and O-isotopic compositions that plot near or below the terrestrial fractionation (TF) line. They have a range of chondrule sizes, from the large rimmed chondrules in CV and CR chondrites to the small chondrules in CH chondrites (Table 1, Fig. 2). Although many C chondrites (e.g., CI, CM, CO, CV, CR) are matrix-rich, some (e.g., CH, CB) are matrix-poor.

5.1.1. CI (Ivuna-type) chondrite group/clan. The CI chondrites (seven members are known) are often considered the most primitive solar system materials, having bulk compositions close to that of the solar photosphere. They are altered, brecciated rocks devoid of chondrules and CAIs. All the CI chondrites are of petrologic type 1, indicating that they are heavily hydrated meteorites consisting of fine-grained, phyllosilicate-rich matrix with minor magnetite, sulfides, sulfates, and carbonates, and rare isolated olivine and pyroxene fragments (e.g., *McSween and Richardson*,

1977; Endress and Bischoff, 1993, 1996; Endress et al., 1996; Leshin et al., 1997). It is not clear if the CI chondrites ever contained chondrules and CAIs and are essentially all matrix component, or if the chondrules and CAIs were consumed and their primary chondrite textures destroyed during extensive aqueous alteration. It is noteworthy, and somewhat miraculous, that the CI chondrites have the most primitive chemical compositions (similar to that of the solar photosphere) despite their being hydrothermally altered, brecciated chondrites with their primary mineralogy entirely erased.

The CI chondrites have been assigned to a separate clan because there is nothing to link them to the chondrite groups in the other clans (Kallemeyn and Wasson, 1981).

5.1.2. CM-CO clan. The CM (Mighei-like) chondrites are the most abundant group of C chondrites. In addition, CM-like materials commonly occur as clasts in other chondrite groups and achondrites (e.g., Zolensky et al., 1996), suggesting their wide distribution in the early solar system. They are characterized by relatively small (~300 μm) chondrules (Fig. 2j), CAIs, and AOAs that have been partially to completely replaced by phyllosilicates. Although most CM chondrites are of petrologic type 2 (CM2), the degree of aqueous alteration experienced by CM chondrites varies widely (e.g., McSween, 1979; Browning et al., 1996). Some CM chondrites [Yamato (Y) 82042 and EET 83334] contain virtually no anhydrous silicates and have been classified as petrologic type 1 (CM1) (Zolensky et al., 1997).

Bells is an example of an anomalous CM chondrite (Rowe et al., 1994; Brearley, 1995; Mittlefehldt, 2002). Its matrix has a higher abundance of magnetite than typical CM chondrites, and the matrix phyllosilicates are more similar to those in CI chondrites. Bells has refractory-lithophile-element abundances like those of CI chondrites, but its moderately volatile- and volatile-lithophile-element abundances are like those of CM chondrites. Refractory-siderophile-element abundances are higher than those of CI chondrites, and Fe, Co, and Ni abundances are at CI levels (Kallemeyn, 1995; Mittlefehldt, 2002).

The CO (Ornans-like) chondrites have relatively small (~150 μm) chondrules (Rubin, 1989) and relatively high matrix abundances (30–45 vol%). They range in petrologic type from 3.0 to 3.7 (McSween, 1977a; Scott and Jones, 1990). Chondrules, CAIs, and AOAs in metamorphosed CO chondrites contain secondary minerals (e.g., nepheline, sodalite, ferrous olivine, hedenbergite, andradite, and ilmenite); these secondary minerals are virtually absent in the more pristine CO3.0 chondrites (e.g., Rubin et al., 1985; Keller and Buseck, 1990a; Tomeoka et al., 1992; Rubin, 1998; Russell et al., 1998a). Whole-chondrite O-isotopic compositions of the CO chondrites plot along the CCAM line, overlapping with those of the CV chondrites (Plate 3).

Allan Hills A77307 is a CO3.0 chondrite and is commonly referred to as the most primitive CO chondrite (e.g., Brearley, 1993). However, it is significantly depleted in ^{18}O , has smaller chondrules and higher matrix content (~40–50 vol%) compared to other CO chondrites, and its bulk com-

position is more like that of CM than CO chondrites, making its classification uncertain (Scott et al., 1981; Kallemeyn and Wasson, 1982; Sears and Ross, 1983; Rubin, 1989; Greenwood et al., 2002).

Three characteristics have been used to link the CM and CO chondrites and support a CM-CO clan (Kallemeyn and Wasson, 1982): (1) chondrules are similar in size and anhydrous minerals have similar compositions; (2) refractory-lithophile-element abundances are similar; and (3) O-isotopic compositions of high-temperature minerals are similar.

5.1.3. CK-CV clan. The CV (Vigarano-like) chondrites have a high abundance of matrix, large (about 1 mm) chondrules, and a high abundance of large CAIs and AOAs (Table 1, Plate 4). All the CV chondrites are classified as type 3. They are a diverse group of meteorites divided into oxidized (CV_{ox}) and reduced (CV_{red}) subgroups, largely based on modal metal/magnetite ratios and Ni content of metal and sulfides (McSween, 1977b). Subsequently, Weisberg et al. (1997a) subdivided oxidized CVs into the Allende-like (CV_{oxA}) and Bali-like (CV_{oxB}) subgroups. Thus, three subgroups (CV_{red} , CV_{oxA} , CV_{oxB}) are now recognized.

Division of the CV chondrites is based mainly on their petrologic characteristics. Matrix/chondrule ratios increase in the order CV_{red} (0.5–0.6)– CV_{oxA} (0.6–0.7)– CV_{oxB} (0.7–1.2), whereas metal/magnetite ratios tend to decrease in the same order. The whole-rock O-isotopic compositions of the CV chondrites plot along the CCAM line, with the CV_{oxB} chondrites being slightly depleted in ^{16}O relative to the CV_{red} and CV_{oxA} chondrites. Although all the CV chondrites have been classified as type 3, the CV_{oxB} chondrites contain abundant (hydrated) phyllosilicates and can be classified as type 2 (e.g., Tomeoka and Buseck, 1990; Keller and Buseck, 1990b; Keller et al., 1994). Recent studies have shown that there are significant mineralogical differences between the CV subgroups resulting from varying degrees of late-stage alteration (Krot et al., 1998, 1995, 2003). Thus, these subgroups may reflect secondary characteristics superimposed onto the members of this meteorite group.

The CV_{oxB} chondrites experienced aqueous alteration and contain hydrous phyllosilicates, magnetite, Fe,Ni-sulfides, Fe,Ni-carbides, fayalite, Ca,Fe-pyroxenes (Fs_{10-50} Wo_{45-50}), and andradite. The CV_{oxB} matrices consist of very fine-grained (<1–2 μm) ferrous olivine (~ Fa_{50}), concentrically zoned nodules of Ca,Fe-pyroxenes and andradite, coarse (>10 μm) grains of nearly pure fayalite ($\text{Fa}_{>90}$), and phyllosilicates (Fig. 6). The CV_{oxA} chondrites are more extensively altered than the CV_{oxB} , but contain very minor phyllosilicates. The major secondary minerals include ferrous olivine (Fa_{40-60}), Ca,Fe-pyroxenes, andradite, nepheline, sodalite, Fe,Ni-sulfides, magnetite, and Ni-rich metal. The CV_{oxA} matrices are coarser-grained than those in the CV_{oxB} chondrites and largely consist of lath-shaped ferrous olivine (~ Fa_{50}), Ca, Fe-pyroxene \pm andradite nodules, and nepheline (Fig. 6). Some oxidized CVs [e.g., Meteorite Hills (MET) 00430] are mineralogically intermediate between the CV_{oxB} and CV_{oxA} chondrites. For example, the matrix in MET 00430 contains ferrous olivine with grain sizes inter-

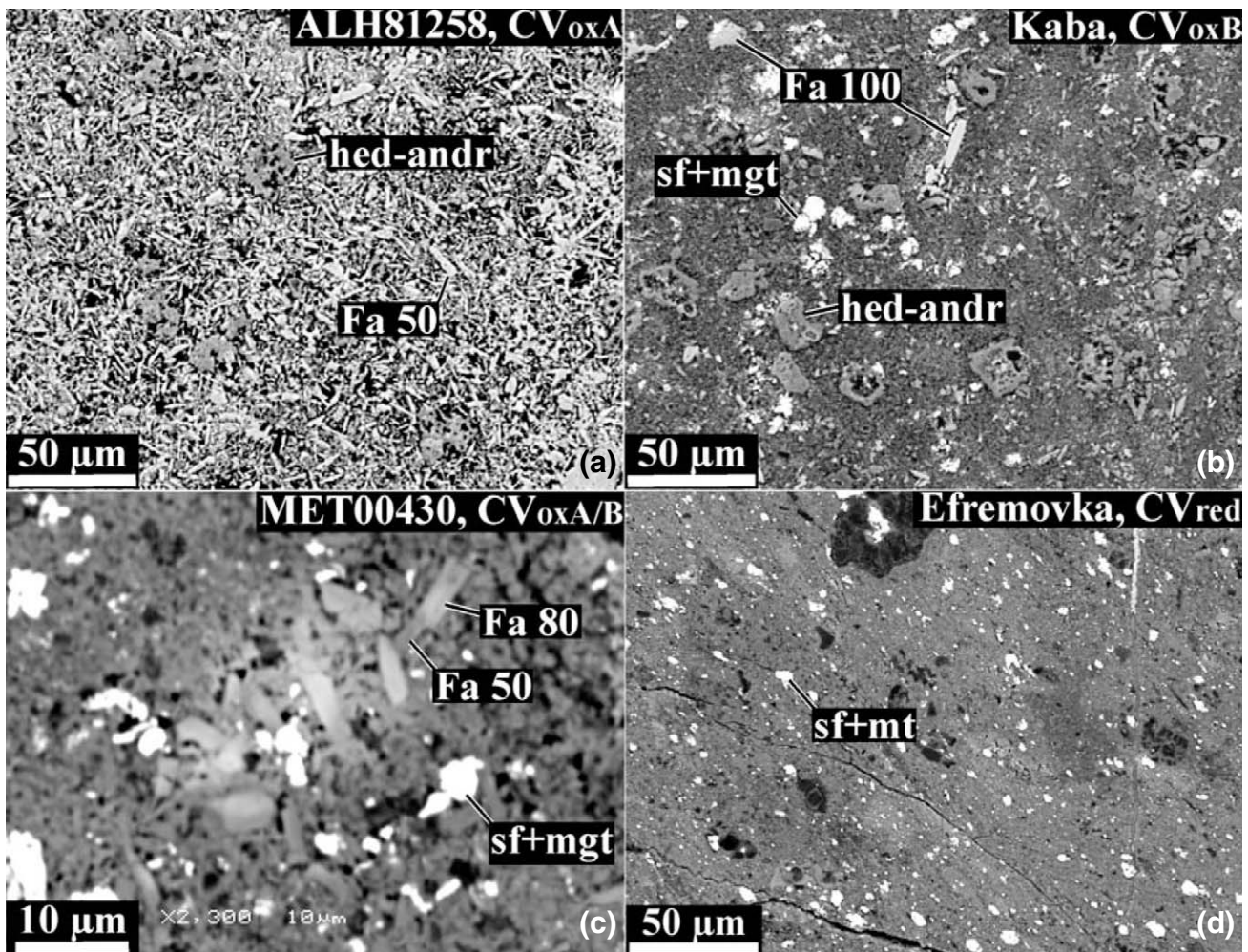

Fig. 6. Backscattered electron images of matrices in (a) ALH 81258 (CV_{oxA}), (b) Kaba (CV_{oxB}), (c) MET 00430 (CV_{oxA/B}), and (d) Efremovka (CV_{red}). Matrix in ALH 81258 contains lath-shaped, relatively coarse-grained and compositionally uniform (~Fa₅₀) ferrous olivine. Matrix in Kaba contains nearly coarse grains of nearly pure fayalite (~Fa₁₀₀), sulfide-magnetite grains (sf-mgt), and very fine-grained groundmass largely composed of ferrous olivine (~Fa₅₀). Matrix in MET 00430 contains fayalite grains showing inverse compositional zoning (Fa₈₀₋₅₀), sulfide-magnetite grains, and fine-grained, lath-shaped ferrous olivine (~Fa₅₀). Matrix in Efremovka is heavily compacted by shock metamorphism; it is largely composed of ferrous olivine (~Fa₅₀) and sulfide-Fe,Ni-metal (sf-mt) grains. All matrices contain Ca,Fe-pyroxenes-andradite (hed-andr) nodules; the Efremovka matrix has the lowest abundance of these nodules.

mediate between those in the matrices of the CV_{oxA} and CV_{oxB} chondrites and with inverse compositional zoning (Fa₈₀₋₅₀). The reduced CV chondrites Efremovka and Leoville experienced alteration similar to that of the CV_{oxA} meteorites, but of a smaller degree. Both meteorites virtually lack phyllosilicates and contain nepheline, sodalite, and Ca,Fe-pyroxenes; however, these minerals are much less abundant than in the CV_{oxA} meteorites. The CV chondrite Mokoia contains clasts of the CV_{oxA} and CV_{oxB} materials (Krot *et al.*, 1998). The CV chondrite breccia Vigarrano contains the CV_{red}, CV_{oxB}, and CV_{oxA} materials (Krot *et al.*, 2000c). These observations may indicate that the CV subgroups represent different lithological varieties of the CV asteroidal body that experienced complex, multistage alteration.

The CK (Karoonda-like) chondrites contain a high abundance of matrix and large chondrules (700–1000 μm), most

of which have porphyritic textures. Chondrules with glassy, cryptocrystalline, or barred olivine textures are rare. The CK chondrites are highly oxidized, as indicated by high fayalite contents of their olivine (Fa₂₉₋₃₃), nearly complete absence of Fe,Ni-metal, high Ni content in sulfides, and abundant magnetite with exsolution lamellae of ilmenite and spinel. The whole-rock O-isotopic compositions of the CK chondrites plot along the CCAM line, within the range of the CO and CV chondrites (Plate 3a). Their refractory-lithophile-element abundances (~1.2× CI) are between those of CV and CO chondrites with depletions in moderately volatile elements greater than those of CV and CO chondrites (Kallemeyn *et al.*, 1991). Most CK chondrites are of high (4–6) petrologic type.

The CK chondrites of low petrologic type (<4) show some chemical, mineralogical, and petrographic similarities to the CV chondrites (Greenwood *et al.*, 2005). For ex-

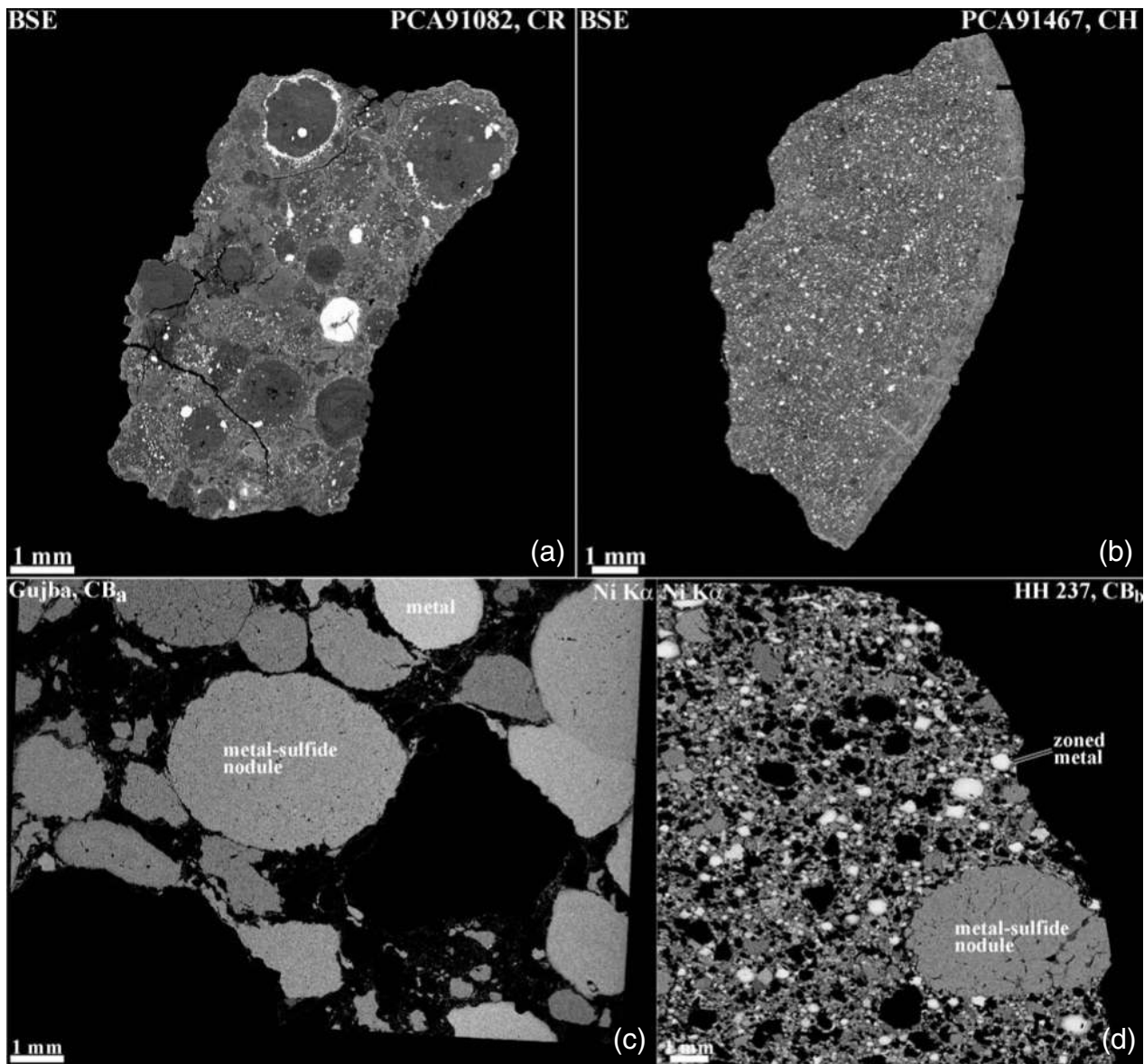

Fig. 7. Backscattered electron images [(a),(b)] and elemental maps in Ni $K\alpha$ X-rays [(c),(d)] of the (a) CR chondrite PCA 91082, (b) CH chondrite PAT 91546, (c) CB_a chondrite Gujba, and (d) CB_b chondrite Hammadah al Hamra 237. In the CR chondrite PCA 91082 (a), FeNi-metal occurs as nodules in chondrules, igneous rims around chondrules, and in the matrix. In the CH chondrite PAT 91546 (b), FeNi-metal occurs largely as irregularly shaped grains outside. In the CB_a chondrite Gujba (c), FeNi metal occurs as large nodules several millimeters in size. In the CB_b chondrite Hammadah al Hamra 237 (d), metal occurs as both large nodules, like those in CB_b chondrites, and as numerous smaller spherical to irregularly shaped nodules.

ample, the CK3 and the oxidized CV3 chondrites have a similar range of O-isotopic compositions on the CCAM line and their magnetites have similar compositions (e.g., *Greenwood et al.*, 2005). Ningqiang is an ungrouped C chondrite with characteristics that overlap CV and CK (*Rubin et al.*, 1988; *Kallemeyn et al.*, 1991; *Kallemeyn*, 1996; *Koeberl et al.*, 1987; *Mayeda et al.*, 1988; *Guimon et al.*, 1995). These observations support a close (clan) relationship between the CK and CV chondrites, which needs further study.

5.1.4. CR clan. Most CR (Renazzo-like) chondrites are of petrologic type 2 and are characterized by large (millimeter-sized), Fe,Ni-metal-rich, porphyritic, forsterite- or

enstatite-rich (type I) chondrules, some of which are multi-layered, with rims of metal and silicates (olivine, pyroxene, glassy mesostasis, \pm silica phase or phyllosilicates in the more-altered chondrules) (*Weisberg et al.*, 1993) (Fig. 2g,h and Fig. 7a, Plate 5a). The abundances of CAIs and AOA are relatively low. Grosvenor Mountains (GRO) 95577 contains no anhydrous silicates and is classified as a CR1 chondrite (*Weisberg and Prinz*, 2000). Matrix ranges from 40 to 70 vol% and is hydrated, containing phyllosilicates, magnetites, carbonates, and sulfides. Matrix-like fragments, commonly referred to as dark inclusions, are common in the CR chondrites. An intriguing aspect of the CR chondrites is that

the Fe,Ni-metal in the matrix and chondrules shows a large compositional range with a positive Ni vs. Co trend and with a solar Ni/Co ratio, suggesting it is a highly primitive material. The whole-rock refractory-lithophile-element abundances of CR chondrites are close to solar, while the moderately volatile lithophiles are highly depleted (Fig. 3). On the O three-isotope diagram, the CR chondrites define a unique mixing line, of slope ~ 0.7 , that differs from the CCAM line and the CM chondrite line (Plate 3a). The whole-rock N-isotopic compositions show large positive anomalies with $\delta^{15}\text{N}$ up to $\sim 200\text{‰}$ (Weisberg *et al.*, 1993), suggesting a heavy N carrier in the CR chondrites, the identity of which has not yet been resolved. The mineralogy, petrology, and chemistry of CR chondrites and their components are described in detail in several papers (McSween, 1977b; Bischoff *et al.*, 1993a; Weisberg *et al.*, 1993, 2004; Kallemeyn *et al.*, 1994; Krot *et al.*, 2000a, 2002a,b; Aléon *et al.*, 2002).

Al Rais is considered to be an anomalous CR chondrite due to a high matrix (and dark inclusions) component (>70 vol%), which is reflected in its whole-chondrite chemical and O-isotopic composition (Weisberg *et al.*, 1993). It may simply be a breccia that acquired a larger amount of the matrix (or dark inclusion) component than other CR chondrites.

The CH (ALH 85085-like) chondrites are characterized by small (<50 – 100 μm in diameter) chondrules, which are mostly cryptocrystalline in texture, and high abundance of Fe,Ni-metal (~ 20 vol%) (Fig. 2k and Fig. 7b, Plate 5b) with a large range in composition, positive Ni vs. Co trend, and a solar Ni/Co ratio. Interchondrule matrix is virtually absent; heavily hydrated, lithic, matrix-like clasts are present. CH chondrites have $\sim\text{CI}$ bulk refractory-lithophile-element abundances, but are highly depleted in volatile and moderately-volatile lithophile elements. Whole-rock O-isotopic compositions plot along the CR-mixing line; whole-rock N isotopic compositions show large positive anomalies in $\delta^{15}\text{N}$, up to 1000‰ (Wasson and Kallemeyn, 1990; Bischoff *et al.*, 1993b).

The unusual characteristics of the CH chondrites, including the dominance of small cryptocrystalline chondrules, high abundance of metal, and lack of matrix led to the interpretation that the CH chondrites are “subchondritic” meteorites formed as a result of an asteroidal collision and are not true primary materials formed in the solar nebula (Wasson and Kallemeyn, 1990). However, based on the presence of CAIs uniformly enriched in ^{16}O , Fe,Ni-metal condensates, and pristine chondrules in CH chondrites, it was suggested that these meteorites are in fact pristine products of the solar nebula (Grossman *et al.*, 1988; Scott, 1988; Weisberg *et al.*, 1988; Meibom *et al.*, 1999; Krot *et al.*, 2000b). However, the origin of these meteorites is currently being studied.

The CB (Bencubbin-like) chondrites have characteristics that sharply distinguish them from other chondrites (Weisberg *et al.*, 2001); these include (1) very high metal abundances (60–80 vol%), (2) almost exclusively cryptocrystal-

line and barred textures of chondrules (Fig. 2l and Fig. 7c,d, Plate 5c,d), (3) large depletion in moderately-volatile-lithophile elements, and (4) large enrichment in heavy N.

Based on their petrologic and chemical characteristics, the CB chondrites are divided into the CB_a (Gujba, Bencubbin, Weatherford) and CB_b (Hammadah al Hamra 237, QUE 94411) subgroups (Weisberg *et al.*, 2001, 2002). The CB_a chondrites contain ~ 60 vol% metal, chondrules are centimeter-sized, Fe,Ni-metal contains 5–8 wt% Ni, and $\delta^{15}\text{N}$ is up to $\sim 1000\text{‰}$. The CB_b contain >70 vol% metal, chondrules are millimeter-sized, Fe,Ni-metal contains 4–15 wt% Ni, and $\delta^{15}\text{N}$ is $\sim 200\text{‰}$.

The origin and significance of the CB chondrites have generated much controversy. They have been interpreted to be highly primitive nebular materials containing metal that condensed directly from the solar nebula (Newsom and Drake, 1979; Weisberg *et al.*, 1990, 2001; Meibom *et al.*, 1999, 2000a, 2001; Campbell *et al.*, 2001; Petaev *et al.*, 2001; Krot *et al.*, 2002b). Others argue that CB chondrites formed in a vapor cloud produced during an impact event on a chondritic planetesimal (Kallemeyn *et al.*, 1978; Campbell *et al.*, 2002). Like in CH chondrites, fine-grained matrix material is essentially absent, but rare matrix-like clasts are present in some CB chondrites (Lovering, 1962; Mason and Nelen, 1968; Kallemeyn *et al.*, 1978; Newsom and Drake, 1979; Weisberg *et al.*, 1990, 2001; Rubin *et al.*, 2001; Krot *et al.*, 2001a, 2002b; Greshake *et al.*, 2002). It has also been suggested that the CB_b chondrites are the primitive nebular-formed chondritic materials and the CB_a chondrites are products of impact onto a CB_b -like target material (Campbell *et al.*, 2002). An intriguing characteristic of CB chondrites is that they all contain impact melt areas between the metal and silicate chondrules, which could be a shock-melted matrix material (Newsom and Drake, 1979; Weisberg *et al.*, 1990, 2001; Krot *et al.*, 2002b; Meibom *et al.*, 2000b).

The CR, CH, and CB chondrite groups and the ungrouped meteorite LEW 85332 (discussed below) have grossly different petrographic characteristics (Plate 5, Fig. 7) as well as differences in bulk chemistry (see above). However, they all share a number of characteristics that suggest a close relationship, and as a result are grouped together into the CR clan (Weisberg *et al.*, 1995a, Krot *et al.*, 2002b). Members of the CR clan have the following similar characteristics: (1) They are all metal-rich, but metal abundances vary widely among them (Table 1); (2) Fe,Ni-metal has a broad compositional range and is characterized by an approximately solar Ni/Co ratio; (3) they are highly depleted in moderately-volatile lithophile elements, with the depletions correlating with increasing volatility (Fig. 3); (4) their bulk O-isotopic compositions plot on or near the CR-mixing line on a three-isotope diagram (Plate 3a); (5) their bulk N isotopic compositions have large positive anomalies in $\delta^{15}\text{N}$ ranging from 200‰ in the CR chondrites to $>1000\text{‰}$ in the CB and CH chondrites; (6) most of their anhydrous mafic silicates are Mg-rich (Fa and Fs <4 mol%); and (7) they contain heavily-hydrated matrix and/or matrix lumps composed

of serpentine, saponite, sulfides, framboidal and platelet magnetites, and carbonates.

5.2. Ordinary (O) Chondrites: H-L-LL Chondrite Clan and Related Meteorites

Ordinary chondrites include the H, L, and LL groups. The O chondrites are the most common materials in our meteorite collections, constituting more than 85% of observed falls. They are characterized by a high abundance of large (millimeter-sized) chondrules with various textures and mineral compositions. Matrix abundances (10–15 vol%) are generally lower than in C chondrites; CAIs and AOAs are very rare (Table 1). Ordinary chondrites show a wide range in petrologic types from 3 to 6 (Fig. 2a–f), with several less-altered (petrologic types 3.0–3.1) members. Some of the least-metamorphosed O chondrites (e.g., Semarkona and Bishunpur) show evidence for aqueous alteration (e.g., *Hutchison et al.*, 1987; *Alexander et al.*, 1989; *Sears and Weeks*, 1991; *Sears et al.*, 1980, 1991). Hydrous alteration took place mainly in the matrix and in some cases chondrule mesostases (*Hutchison et al.*, 1987). The degree of alteration varies, and Bishunpur appears to be less altered than Semarkona (e.g., *Brearley and Jones*, 1998). The whole-rock Mg-normalized refractory lithophile abundances are $<1 \times$ CI (Fig. 3) and their O-isotopic compositions plot above the TF line, sharply distinguishing them from the C chondrites (Plate 3a,b). In general, the H, L, and LL chondrites have similar, overlapping petrologic characteristics and O-isotopic compositions that indicate they are closely related members of a clan.

A number of parameters are used to resolve the H, L, and LL groups. Small, systematic differences among the O-chondrite groups are observed for metal abundances and chondrule size (Table 1, Fig. 2). On a plot of Co concentration in kamacite vs. fayalite content in olivine, there is a hiatus between H and L, but no hiatus between L and LL chondrites (*Rubin*, 1990). Olivine composition is not a reliable indicator of group for unequilibrated O chondrites of low petrologic type (<3.5), but is successfully used for distinguishing the equilibrated varieties (Table 1). Siderophile-element abundances can also be used to distinguish H, L, and LL (*Kallemeyn et al.*, 1989; *Sears et al.*, 1991).

Several O chondrites (Bjurböle, Cynthiana, Knyahinya, Qidong, Xi Ujimgin) are intermediate between L and LL chondrites, possibly indicating formation on a separate parent body (*Kallemeyn et al.*, 1989). Based on their siderophile-element abundances and olivine and kamacite compositions, Tieschitz and Bremervörde are intermediate between H and L and have been classified as H/L chondrites (*Kallemeyn et al.*, 1989).

The chemical properties of the Burnwell, Willaroy, Suwahib (Buwah), Moorabie, Cerro los Calvos, and Wray (a) ordinary chondrites plot on extensions of the H-L-LL trends of O chondrites toward more reducing compositions and may represent a fourth group. These meteorites have lower fayalite contents in olivine (Fa_{13-15}), ferrosillite in ortho-

pyroxene, Co in kamacite (0.30–0.45 wt%), and FeO in their whole-chondrite chemical compositions and their bulk O-isotopic compositions are heavier than those of equilibrated H chondrites. However, their abundances of refractory lithophile elements, Zn and other elements, and their matrix/chondrule abundance ratios are typical of O chondrites (*Wasson et al.*, 1993; *McCoy et al.*, 1994; *Russell et al.*, 1998b). *Wasson et al.* (1993) argue that the low-FeO chondrites were originally normal H or L chondrites that have been altered by metamorphism in a highly reducing regolith. *McCoy et al.* (1994) and *Russell et al.* (1998b) suggested that reduction did not play a role in establishing their mineral compositions and they are samples from different parent bodies than those of the H, L, and LL chondrites.

5.3. Enstatite (E) Chondrites: EH-EL Chondrite Clan and Related Meteorites

Enstatite chondrites formed under highly reducing nebular conditions, as recorded by their mineralogy and mineral chemistry (e.g., *Keil*, 1968). They contain Fe-poor silicates and Si-bearing metal, and elements that are generally lithophile in most meteorite groups (Mn, Mg, Ca, Na, K) can behave as chalcophile elements. Enstatite (MgSiO_3) is the major silicate mineral in the chondrules. Chondrule olivine rarely occurs in low petrologic types (EH3 and EL3) chondrites and is essentially absent in the higher petrologic types. Additionally, they contain a variety of unusual sulfide, metal, and nitride phases that are essentially absent in other chondrite groups. These include oldhamite (CaS), niningerite [$(\text{Mg,Fe,Mn})\text{S}$], alabandite [$(\text{Mn,Fe})\text{S}$], osbornite (TiN), sinoite ($\text{Si}_2\text{N}_2\text{O}$), Si-rich kamacite, daubreelite (FeCr_2S_4), caswellsilverite (NaCrS_2), and perryite [$(\text{Ni,Fe})_x(\text{Si,P})$]. They are the only chondrites with O-isotopic compositions that plot on the TF line and close to the O composition of Earth and the Moon (Plate 3) (*Clayton et al.*, 1984).

The E chondrites are divided into EH and EL groups. The composition of the $(\text{Mg,Mn,Fe})\text{S}$ phase clearly distinguishes the EH and EL chondrites. The EH chondrites are more reduced than the EL chondrites and contain niningerite and various alkali sulfides (e.g., caswellsilverite, djerfisherite), while alabandite is characteristic for EL chondrites (e.g., *Keil*, 1968; *Lin and El Goresy*, 2002). In addition, EH chondrites have higher Si (2–3 wt%) in the Fe,Ni-metal, whereas EL chondrites generally have less than 1.0 wt% Si in the metal. Two E chondrites, LEW 87223 and Y 793225, are ungrouped (*Grossman et al.*, 1993; *Weisberg et al.*, 1995b; *Lin and Kimura*, 1998). *Lin and Kimura* showed that Y 793225 sulfide has an intermediate composition between niningerite and alabandite and *Kimura et al.* (2005) referred to Y 793225 as “EI,” because its mineral compositions are intermediate between EH and EL chondrites.

The EH and EL chondrites range in petrologic type from EH3 to EH5 and from EL3 to EL6. EH3 chondrites differ from EL3 in having higher modal abundances of sulfides

(7–16 vol% vs. 7–10 vol%), lower abundances of enstatite (56–63 vol% vs. 64–66 vol%), and more Si-rich (1.6–4.9 wt% vs. 0.2–1.2 wt%) and Ni-poor (2–4.5 wt% vs. 3.6–8.7 wt%) metal compositions. Lewis Cliff 87223 differs from both EH3 and EL3 chondrites in having the highest abundance of metal (~17 vol%) and FeO-rich enstatite, and the lowest abundance (~3 vol%) of sulfides (*Weisberg et al.*, 1995b).

Some meteorites are classified as E-chondrite melt rocks (*McCoy et al.*, 1995; *Weisberg et al.*, 1997b; *Rubin and Scott*, 1997). They are complex meteorites that have homogeneous, in some cases coarse-grained (millimeter-sized enstatite), achondritic textures and are chemically and O-isotopically similar to the E chondrites. Some are metal-rich with as much as 25 vol% metal. These E-chondrite melt rocks have been interpreted to be the result of impact melting on the E-chondrite-like parent bodies (*McCoy et al.*, 1995; *Rubin and Scott*, 1997) or internally derived melts (*Olsen et al.*, 1977; *Weisberg et al.*, 1997b; *Patzer et al.*, 2001). Itqiy is an E-chondrite melt rock that is depleted in plagioclase and has a fractionated REE pattern that suggests it may be the product of partial melting (*Patzer et al.*, 2001).

5.4. R (Rumuruti-like) Chondrites

The R chondrites (56 are known) have refractory-lithophile-element abundances and O-isotopic compositions that are consistent with placing within the O-chondrite class, but this has not yet been established. They are quite different from the H, L, and LL chondrites. They are highly oxidized meteorites characterized by NiO-bearing, FeO-rich olivine (Fa_{37–40}) and nearly complete absence of Fe,Ni-metal. They have a very high abundance of matrix (~50 vol%) similar to some C chondrites. Most R chondrites are metamorphosed (petrologic type >3.6) and are brecciated. Although the refractory and moderately volatile-lithophile-element abundances of the R chondrites are similar to those of O chondrites (~0.95× CI), absence of significant depletions in Mn and Na and enrichment in volatile elements such as Ga, Se, S, and Zn distinguish R chondrites from H, L, and LL chondrites. The R chondrites have whole-rock $\Delta^{17}\text{O}$ values higher than for any other chondrite group (Plate 3) (*Weisberg et al.*, 1991; *Bischoff et al.*, 1994; *Rubin and Kallemeyn*, 1994; *Schulze et al.*, 1994; *Kallemeyn et al.*, 1996; *Russell*, 1998).

5.5. Ungrouped Chondrites

There are a number of chondrites that do not fit into any of the existing chondrite groups. These meteorites are referred to as ungrouped. In many cases, they have characteristics that are intermediate between chondrite groups. They may be anomalous members of chondrite groups or the first representatives of new groups.

Acfer 094 is a type 3 C-chondrite breccia with mineral compositions, petrologic characteristics, N-isotopic, and O-isotopic similarities to the CM and CO chondrites (*Newton et al.*, 1995; *Greshake*, 1997). Its bulk chemical composition

is similar to that of CM chondrites, and O-isotopic composition and matrix modal abundance are similar to those of CO chondrites. In contrast to CM chondrites, Acfer 094 shows no evidence for aqueous alteration and has a different C-isotopic composition.

Adelaide is an ungrouped, type 3 C chondrite with affinities to the CM-CO clan, but appears to have escaped the thermal metamorphism and aqueous alteration commonly observed in the CM and CO chondrites (*Fitzgerald and Jones*, 1977; *Davy et al.*, 1978; *Kallemeyn and Wasson*, 1982; *Hutcheon and Steele*, 1982; *Kerridge*, 1985; *Brearley*, 1991; *Huss and Hutcheon*, 1992; *Krot et al.*, 2001b,c).

Coolidge and Loongana 001 comprise a C-chondrite grouplet with chemical, O-isotopic, and petrographic characteristics similar to those of the CV chondrites (*Kallemeyn and Wasson*, 1982; *Scott and Taylor*, 1985; *Noguchi*, 1994; *Kallemeyn and Rubin*, 1995). However, both meteorites are of higher petrologic type, 3.8–4, and have smaller chondrules and lower volatile-element abundances than CV chondrites. They may be part of the CK-CV clan.

The K-chondrite (Kakangari-like) grouplet consists of two meteorites, Kakangari and LEW 87232, that are chemically, mineralogically, and isotopically distinct from the O, E, and C classes (*Srinivasan and Anders*, 1977; *Davis et al.*, 1977; *Zolensky et al.*, 1989; *Brearley*, 1989; *Weisberg et al.*, 1996a). Lea County 002 may also be classified as a K chondrite (*Prinz et al.*, 1991; *Weisberg et al.*, 1996a). The K chondrites have high matrix abundance (70–77 vol%) like some C chondrites, metal abundances (6–9 vol%) similar to H chondrites, and average olivine (Fa₂) and enstatite (Fs₄) compositions are Fe-poor, indicating an oxidation state intermediate between H and E chondrites. The matrix of K chondrites is mineralogically unique and composed largely of enstatite (Fs₃) that is compositionally similar to that in the chondrules.

The K chondrites have refractory-lithophile- and volatile-element abundances similar to those of the O chondrites. Chalcophile-element abundances are between those of H and E chondrites. Their whole-rock O-isotopic compositions plot below the TF line on the three-isotope diagram (Plate 3), near the CR, CB, and CH chondrites (CR mixing line). K chondrites are excellent candidates for being the first members of a fourth major class of chondrites.

Kaidun is a complex chondritic breccia that appears to consist mainly of C-chondrite material, but also contains clasts of E and O chondrites. Several C-chondrite groups may be present (*Ivanov*, 1989; *Clayton and Mayeda*, 1999; *Zolensky and Ivanov*, 2003).

Lewis Cliff 85332 is an ungrouped, metal-rich type 3 C-chondrite breccia with chemical, O-isotopic, and petrographic characteristics similar to those of the CR chondrites and is considered a member of the CR clan (*Rubin and Kallemeyn*, 1990; *Prinz et al.*, 1992; *Weisberg et al.*, 1995a; *Brearley*, 1997).

MacAlpine Hills (MAC) 87300 and MAC 88107 comprise a grouplet of type 2–3 C chondrites with bulk chemical compositions intermediate between those of CO and CM chondrites, and O-isotopic compositions similar to those of

the CK chondrites (Clayton and Mayeda, 1999). Contrary to the CM chondrites, which have low natural or induced thermoluminescence (TL), MAC 87300 and MAC 88107 have high TL (Sears et al., 1991). They experienced very minor aqueous alteration that resulted in formation of saponite, serpentine, magnetite, Ni-bearing sulfides, fayalite, and hedenbergite (Krot et al., 2000c).

Ningqiang is an ungrouped C chondrite that shares many petrologic as well as O-isotopic and TL characteristics with CV and CK chondrites (Rubin et al., 1988; Kallemeyn et al., 1991; Kallemeyn, 1996; Koeberl et al., 1987; Mayeda et al., 1988; Guimon et al., 1995). As a result, it has been classified as CV-anomalous (Koeberl et al., 1987; Rubin et al., 1988; Weisberg et al., 1996b) and as CK-anomalous (Kallemeyn et al., 1991). Whichever is correct, it is clearly a member of the CK-CV clan.

Belgica 7904, Y 86720, Y 82162, and Dhofar 225 have petrographic, mineralogical, and chemical affinities to the CM and CI chondrites but have distinct O-isotopic compositions and appear to have experienced aqueous alteration followed by reheating and dehydration (e.g., Akai, 1988; Tomeoka et al., 1989; Tomeoka, 1990; Paul and Lipschutz, 1990; Bischoff and Metzler, 1991; Ikeda, 1992; Ikeda and Prinz, 1993; Hiroi et al., 1993a, 1996; Clayton and Mayeda, 1999; Ivanova et al., 2002).

Sahara 00182 (SAH 00182) is an ungrouped metal-rich C3 chondrite (Grossman and Zipfel, 2001; Weisberg, 2001). It contains large (up to 2 mm diameter), metal-rich, multi-layered chondrules that are texturally similar to those in the CR chondrites. However, it differs from the CR chondrites in that its chondrules contain troilite (FeS), and the chondrules and matrix lack the (secondary alteration) hydrous phyllosilicates that are characteristic of many CR chondrites. Its whole-chondrite O-isotopic composition plots on the C3 (carbonaceous chondrite anhydrous mineral) mixing line (Grossman and Zipfel, 2001).

Tagish Lake is an ungrouped C chondrite that has similarities to CI and CM chondrites (Brown et al., 2000; Grady et al., 2002; Mittlefehldt, 2002; Zolensky et al., 2002). It is a type 2, hydrously altered chondrite composed of two lithologies that have been altered to different degrees (Zolensky et al., 2002). Its whole-rock refractory-lithophile-element abundances are similar to those of CM chondrites and its moderately volatile and volatile-lithophile-element abundances are intermediate between CI and CM (Mittlefehldt, 2002; Friedrich et al., 2002). Siderophile and chalcophile elements are also similar to both CI and CM (Mittlefehldt, 2002; Friedrich et al., 2002).

6. PROPERTIES OF PRIMITIVE ACHONDRITES

6.1. Ureilites

The ureilites are a major group of primitive achondrites with almost 200 known specimens; most are monomict and some are polymict breccias. They have textures, mineralogies, and lithophile-element chemistries that suggest they are

highly fractionated rocks from an achondrite parent body, yet their O-isotopic compositions do not follow a mass-dependent fractionation trend characteristic of planetary differentiation. Instead, they plot along the CCAM line, suggesting a possible relationship to the CV chondrites (Plate 3) (e.g., Clayton and Mayeda, 1988).

Ureilites are olivine-pyroxene rocks with interstitial C (graphite and microdiamonds) mixed with metal, sulfides, and minor silicates. There are three major types of ureilites: (1) olivine-pigeonite, (2) olivine-orthopyroxene, and (3) polymict ureilites. Most ureilites are essentially devoid of feldspar with the exception of the polymict ureilites and some rare exceptions. The ureilites that have not been heavily modified by shock typically display large, elongate olivine and pyroxene grains (about 1 mm in size) that form triple junctures and have curved intergranular boundaries (Plate 1a). Some ureilites display a mineral fabric suggestive of crystal settling and/or compaction.

The presence of interstitial C adds to the challenge of understanding ureilite petrogenesis. It contains trapped noble gases in abundances similar to those of primitive chondrites. One would expect these gases to have been driven off if the ureilites formed during high-temperature igneous processes. Late-stage injection may provide a better explanation for the retention of the noble gases in the C. Another question concerning the C is the relationship of the diamonds to the graphite. Are the diamonds shock-formed or the result of chemical vapor deposition in the early solar nebula? One well-known characteristic of the ureilites is that olivine in contact with the graphite has experienced reduction of Fe. Evidence of the reduction reaction is visibly displayed in olivine grains having reduced rims that are composed of Fe-poor olivine speckled with tiny blebs of low-Ni metal.

The polymict ureilites (e.g., North Haig, Nilpena, EET 83309, EET 87720, Dar al Gani (DaG) 319, and DaG 164/165) are polymict breccias that contain a variety of rock (lithic) and mineral fragments. The clasts that they contain include monomict ureilite fragments, feldspar-bearing lithic clasts, isolated mineral fragments, chondrite and chondrule fragments, and dark chondritic inclusions (Ikeda and Prinz, 2000; Ikeda et al., 2000; Kita et al., 2004).

Because of their gross petrologic similarities to terrestrial ultramafic rocks, ureilites have been perceived to be products of internal magmatic differentiation. The olivine-augite-orthopyroxene ureilites appear to resemble magmatic cumulates (e.g., Goodrich et al., 1987, 2001). The olivine-pigeonite ureilites have been interpreted to be partial melt residues (e.g., Scott et al., 1993; Warren and Kallemeyn, 1992; Goodrich et al., 2002). The missing basaltic component has been explained as being largely lost through explosive volcanism on the ureilite parent body(ies); it may have been preserved in feldspathic material in polymict ureilites [see Goodrich (1992) for a review of models for ureilite petrogenesis]. The observed variations in whole-rock O-isotopic compositions of ureilites may suggest that ureilites formed by melting of chondritic material in a number of isolated magma systems and not from a common magma

source. These observations have led to other models for the origin of ureilites, including a planetesimal-scale collision model involving extraction of partial melt and recrystallization of the mafic minerals to form the ureilites (*Takeda, 1987*) and an origin as primitive aggregates of olivine condensates (*Kurat, 1988*). Most recently, ureilites have been interpreted to be mantle rock from a partially melted asteroid. The ureilite parent body (UPB) may have been stratified in magnesian content and pyroxene type and abundance as a result of the pressure dependence of C-redox reactions (*Goodrich et al., 2004*). Lack of magmatic homogenization may have preserved the primitive O-isotopic signature of the ureilites.

6.2. Acapulcoite-Lodranite Clan

The acapulcoites and lodranites may be considered a primitive achondrite clan. The acapulcoites are fine-grained (150–230 μm), equigranular rocks with approximately chondritic abundances of olivine, pyroxene, plagioclase, metal, and troilite, while lodranites are coarse-grained (540–700 μm) olivine, pyroxene rocks depleted in troilite and plagioclase (Table 2, Plate 1b) (*Nagahara, 1992; McCoy et al., 1996; Mittlefehldt et al., 1998*). The whole-rock O-isotopic compositions of acapulcoites and lodranites are similar and they form a cluster with significant spread on the three-isotope diagram (Plate 3c,d). Rare relict chondrules have been reported in several acapulcoites (e.g., *Schultz et al., 1982; McCoy et al., 1996*), suggesting that they are close to their chondrite precursor and therefore designated primitive achondrite. Acapulcoites likely formed from very low degrees of partial melting at temperatures just above the Fe,Ni-FeS cotectic ($\sim 950^\circ\text{C}$), while lodranites are residues from higher degrees of partial melting and basaltic melt removal at temperatures of $\sim 1250^\circ\text{C}$.

Elephant Moraine 84302 and Graves Nunataks (GRA) 95209 are texturally and mineralogically intermediate between acapulcoites and lodranites (*Takeda et al., 1994; Mittlefehldt et al., 1996; McCoy et al., 1997a,b; Mittlefehldt and Lindstrom, 1998; McCoy and Carlson, 1998*). Lewis Cliff 86220 consists of an acapulcoite host with intruded Fe,Ni-FeS and gabbroic partial melts (*McCoy et al., 1997b*). Frontier Mountain 93001 may be an impact melt from the acapulcoite-lodranite parent body (*Burroni and Folco, 2003*).

6.3. Brachinites

Brachinites are olivine-rich achondrites that show diverse petrology with some having differences in their bulk chemistry and O-isotopic compositions. The brachinites are medium- to coarse-grained (0.1–2.7 mm) equigranular olivine-rich (74–98%) rocks (Plate 1d) that contain minor augite (4–15%), plagioclase (0–10%), orthopyroxene (traces), chromite (0.5–2%), Fe-sulfides (3–7%), phosphates, and Fe,Ni-metal. Lithophile-element abundances in Brachina are close to chondritic and are unfractionated and thus brachin-

ites are considered primitive achondrites. Other brachinites show depletions in Al, Ca, Rb, K, and Na (*Mittlefehldt et al., 1998*). Siderophile-element abundances are variable in brachinites ($\sim 0.1\text{--}1\times\text{CI}$). The petrologic and geochemical differences among the different brachinites suggest that they may not have all formed by the same process or on the same parent body (*Mittlefehldt et al., 1998; Mittlefehldt, 2004*).

Tafassasset and LEW 88763 are two meteorites that are petrologically and chemically similar to the brachinites, but Tafassasset is metal-rich ($\sim 8\text{ vol}\%$) and both Tafassasset and LEW 88763 have O-isotopic compositions that are far removed from the region in which most brachinites plot on the three-isotope diagram (*Nehru et al., 2003*). Instead, they plot close to the CR chondrites on the three-isotope diagram (*Bourot-Denise et al., 2002*). They may have formed by a process similar to that of the other brachinites but clearly represent a different nebular reservoir and parent body. The petrologic and chemical differences among the brachinites suggest that they should not be considered a meteorite group. They may need to be divided into a number of groups.

The origin of brachinites remains controversial. They may represent oxidized and recrystallized chondritic materials, partial melt residues, or igneous cumulates (*Warren and Kallemeyn, 1989; Nehru et al., 1996; Mittlefehldt, 2004*). Mittlefehldt argued that the brachinites are igneous cumulate rocks from a differentiated asteroid and are therefore achondrites and not primitive achondrites.

6.4. Winonaites and IAB and III CD Iron Clan

Winonaites have generally chondritic mineralogy and chemical composition, but achondritic, recrystallized textures (Plate 1e). They are fine- to medium-grained, mostly equigranular rocks, but some (Pontlyfni and Mount Morris) have regions interpreted to be relic chondrules based on their textures. The mineral compositions of winonaites are intermediate between those of E and H chondrites, and Fe,Ni-FeS veins that may represent the first partial melts of a chondritic precursor material are common (*Benedix et al., 1998*).

Silicate inclusions in IAB and III CD irons consist of variable amounts of low-Ca pyroxene, high-Ca pyroxene, olivine, plagioclase, troilite, graphite, phosphates, and Fe,Ni-metal, and minor amounts of daubreelite and chromite. They have similar mineral compositions to winonaites and the O-isotopic compositions of the IAB silicates are similar to those of the winonaites (Plate 3c,d) (*Kracher, 1982; Kallemeyn and Wasson, 1985; Palme et al., 1991; Kimura et al., 1992; McCoy et al., 1993; Choi et al., 1995; Yugami et al., 1997; Takeda et al., 1997; Clayton and Mayeda, 1996; Benedix et al., 1998, 2000*). Based on these similarities, it was inferred that the silicate inclusions in IAB and winonaites formed on the same or similar parent body; it is less clear whether the III CD irons are from the same parent body (*McCoy et al., 1993; Choi et al., 1995; Benedix et al., 1998, 2000*).

7. Properties of Achondrites

Under the heading of achondrite, we include the metal-poor stony meteorites, as well as the stony irons and irons; each of these types contains several meteorite groups and ungrouped members. We apply the term “clan” (which has not been previously used for achondrites) to some achondrite groups.

7.1. Angrites

The Angrites are a perplexing group of achondrites. They are medium- to coarse-grained (up to 2–3 mm) vesicular igneous rocks of generally basaltic composition but unusual mineralogies consisting of Ca-Al-Ti-rich pyroxene, Ca-rich olivine, and anorthitic plagioclase (Plate 2e) with accessory spinel, troilite, kirschsteinite, whitlockite, titanomagnetite, and Fe,Ni metal (e.g., *McKay et al.*, 1988, 1990; *Yanai*, 1994; *Mittlefehldt et al.*, 1998). Interestingly, the type meteorite — Angra dos Reis — is unlike all other Angrites. It is essentially a monomineralic rock consisting of ~90% Ca-Al-Ti-rich pyroxene (e.g., *Prinz et al.*, 1977). Oxygen-isotopic compositions of the Angrites are similar to those of the HED meteorites, brachinites, and mesosiderites (Plate 3c,d). However, the unusual mineralogies and compositions of the Angrites suggest that they are not related to any of these meteorite groups. Angrites are the most alkali-depleted basalts in the solar system and have low abundances of the moderately volatile element Ga. However, they are not notably depleted in the highly volatile elements Br, Se, Zn, In, and Cd compared to lunar basalts and basaltic eucrites. It has been suggested that the Angrites formed from melts enriched in a CAI component (*Prinz et al.*, 1977). Partial melting experiments of a CV chondrite at IW + 1 (*Jurewicz et al.*, 1993) produced melt compositions similar to some bulk Angrites, although olivine xenocrysts appear to be present in other Angrites. It has recently been suggested (*Campbell and Humayun*, 2005) that the volatile-depleted IVB irons may have originated on the same parent body as the Angrites. The origin of Angra dos Reis is uncertain.

7.2. Aubrites

The aubrites are highly reduced achondrites with close affinities to the E chondrites and are often referred to as enstatite achondrites. All the aubrites are breccias with the exception of Shallowater, which has an igneous texture (*Keil et al.*, 1989). They consist mostly (~75–95 vol%) of nearly FeO-free enstatite, with minor albitic plagioclase and nearly FeO-free diopside (Plate 2) and forsterite (e.g., *Watters and Prinz*, 1979). Other phases include accessory Si-bearing Fe,Ni metal (e.g., *Casanova et al.*, 1993) and a variety of sulfides similar to those in the E chondrites (*Watters and Prinz*, 1979; *Keil and Brett*, 1974; *Wheelock et al.*, 1994). The aubrite parent body likely formed by partial melting, removal of that melt, continued melting to very high tem-

peratures (~1600°C), and crystallization, although Shallowater may require an impact mixing origin on a distinct parent body. The highly reduced state, O-isotopic composition, and presence of ferroan alabandite in the aubrites may link them to the EL chondrites. However, they are probably derived from different asteroidal parent bodies (*Keil*, 1989).

7.3. HED Clan: Howardites, Eucrites, Diogenites

Eucrites and diogenites are basalts and orthopyroxene cumulates, respectively, thought to have originated in near-surface flows or intrusives on a common asteroidal parent body. Some of their textural variations are displayed in Plate 2. Many HED meteorites are impact-produced monomict or polymict breccias. Howardites are polymict breccias containing eucritic and diogenitic components (*Fredriksson and Keil*, 1963; *Delaney et al.*, 1984). HED meteorites have similar whole-rock O-isotopic compositions (Plate 3) and similar Fe/Mn ratios in their pyroxenes, suggesting a close genetic relationship (e.g., *Papike*, 1998). Similarities in the mineralogical compositions of the HEDs and the surface mineralogy of asteroid 4 Vesta, as determined by ground-based visible and near-infrared spectroscopy, suggest that the HEDs are probably impact ejecta off this asteroid (*McCord et al.*, 1970; *Binzel and Xu*, 1993). Although classified as a eucrite, Northwest Africa (NWA) 011 differs in its O-isotopic composition and must have originated on a separate parent body (*Yamaguchi et al.*, 2002). Therefore, it should be considered an ungrouped achondrite. The finding of eucrites from additional parent bodies is reassuring, given the identification of core materials (iron meteorites) from dozens of differentiated asteroids.

7.4. Mesosiderites

Mesosiderites are breccias composed of approximately equal proportions of silicates and Fe,Ni-metal plus troilite. Their silicate fraction consists of mineral and lithic clasts in a fine-grained fragmental or igneous matrix (e.g., *Floran*, 1978; *Floran et al.*, 1978; *Hewins*, 1983; *Mittlefehldt et al.*, 1998). The lithic clasts are largely basalts, gabbros, and pyroxenites with minor amounts of dunite and rare anorthosite (*Scott et al.*, 2001). Mineral clasts consist of coarse-grained orthopyroxene, olivine, and plagioclase; Fe,Ni-metal in mesosiderites is mostly in the form of millimeter or submillimeter grains that are intimately mixed with similarly sized silicate grains.

Chaunskij is an unusual, highly metamorphosed, heavily shocked, metal-rich, cordierite-bearing mesosiderite (*Petaev et al.*, 1993).

7.5. Pallasites

Pallasites are essentially olivine (35–85 vol%)-metal (and troilite) assemblages. The term pallasite has been used to indicate a group of meteorites, but there are four separate

kinds of pallasites that are distinguished by differences in their silicate mineralogy and composition, metal composition, and O-isotopic composition. These include (1) the main-group pallasites, (2) the Eagle Station grouplet, (3) the pyroxene-pallasite grouplet (e.g., *Boesenberg et al.*, 1995; *Mittlefehldt et al.*, 1998), and (4) the Milton ungrouped pallasite. The differences among the pallasite groups suggest that they originated on separate asteroidal bodies. Aside from textural similarities, the pallasites appear to be unrelated and therefore the term pallasite does not meet the definition of clan or group. The term pallasite is best thought of as a descriptive/textural term for olivine-metal rocks.

Although O-isotopic compositions of the main-group pallasites are similar to those of the HEDs (Plate 3c,d) and their metal is close in composition to that of Ni-rich IIIAB irons, no genetic relationship between these meteorite groups has been established.

The Eagle Station grouplet is mineralogically similar to the main-group pallasites, but has more ferroan and Ca-rich olivine (*Davis and Olsen*, 1991; *Buseck*, 1977) and different O-isotopic compositions. Their metal is close in composition to IIF irons and has higher Ni and Ir contents than those of the main-group pallasites (*Scott*, 1977). *Kracher et al.* (1980) suggested that Eagle Station grouplet pallasites and IIF irons formed in a close proximity in the solar nebula region but not on the same parent asteroid.

The pyroxene-pallasite grouplet consists of Vermillion and Y 8451 (*Boesenberg et al.*, 1995). These meteorites contain ~14–63 vol% olivine, 30–43 vol% metal, 0.7–3 vol% pyroxene, 0–1 vol% troilite, and minor whitlockite. The occurrence of millimeter-sized pyroxenes, their metal compositions, and their O-isotopic compositions distinguish them from the main-group and Eagle Station grouplet pallasites (*Hiroi et al.*, 1993b; *Boesenberg et al.*, 1995; *Yanai and Kojima*, 1995). One of the most perplexing characteristics of the pallasites is that the pyroxene pallasites fall on a long mixing line drawn from the main-group pallasites to the Eagle Station pallasites (Fig. 3) (*Boesenberg et al.*, 1995). The significance of this line, if any, is unclear.

7.6. Martian Meteorite Clan

The martian meteorites are crustal rocks from Mars. They have been called SNC (an acronym for the shergottites-nakhlites-chassignite groups) and are volcanic (basaltic shergottites and nakhlites) and plutonic (lherzolitic and olivine-phyric shergottites, Chassigny, ALH 84001) rocks. Their O-isotopic compositions differ from those of other meteorites and they define a unique slope-0.52 mass fractionation line (Plate 3), suggesting their origin from the same, differentiated parent body. The relatively young crystallization age of some of these meteorites (<1.3 Ga) suggests derivation from a planet-sized body. Most importantly, gases trapped in impact-produced glass inclusions and veins in some martian meteorites are compositionally and isotopically similar to the martian atmosphere, as determined by

the Viking landers, demonstrating that these meteorites are from the planet Mars (e.g., *McSween and Treiman*, 1998; *Bogard and Johnson*, 1983; *Marti et al.*, 1995; *Nyquist et al.*, 2001; *McSween*, 2002). The acronym SNC does not adequately describe the current variety of martian meteorites in the world's collections. Recent new finds from Antarctica and hot deserts have brought the total number of SNC meteorites to ~35 and have yielded the new types of lherzolitic shergottites (lherzolites) and the famous orthopyroxenite ALH 84001.

The martian meteorites have crystallization ages of a few hundred million years, with the exception of ALH 84001, which has an age of ~4.5 Ga (e.g., *Nyquist et al.*, 2001). Allan Hills 84001 consists mainly of coarse, up to 6 mm long, orthopyroxene crystals (96%), with 2% chromite, 1% plagioclase (maskelynite), 0.15% phosphate, and accessory phases such as olivine, augite, pyrite, and carbonates (*Mittlefehldt*, 1994). One of the most intriguing aspects of this meteorite is that it has been postulated to contain nanofossils, as well as other evidence of life, of martian origin (*McKay et al.*, 1996).

7.7. Lunar Meteorite Clan

Lunar meteorites are classified by their texture, petrology, and chemistry. They include a wide range of rock types including brecciated and unbrecciated mare basalts, mixed mare/highlands breccias, highland regolith breccias, and highland impact-melt breccias [e.g., see *Papike et al.* (1998) for a more detailed description of the lunar meteorites]. The lunar meteorites share many common mineralogical (e.g., Fe/Mn ratios in pyroxenes), bulk chemical, and O-isotopic compositions with the Apollo and Luna samples. However, they almost certainly come from areas not sampled by these missions and some lunar meteorites (e.g., NWA 773), providing sample lithologies unknown from the mission samples.

7.8. Iron Groups and Ungrouped Irons

The classification of irons, perhaps more than any other group of meteorites, is historically deep. The well-known Widmanstätten structure was first recognized in the early nineteenth century by W. Thompson and A. von Widmanstätten. In the 1870s and 1880s, G. Tschermak introduced the structural classification of iron meteorites still used today, dividing them into octahedrites (O), hexahedrites (H), and ataxites [(D), for the German “dicht” (dense)]. He further subdivided the octahedrites by the width of their kamacite bands into Of (“fein,” fine), Om (“mittlere,” medium), and Og (“gros,” large). The structural classification remains a useful tool for the characterization of irons.

In the 1950s, the modern chemical classification of iron meteorites emerged. *Goldberg et al.* (1951) first introduced the concept of grouping irons of similar composition using Ni and Ga. *Lovering et al.* (1957) and *Wasson and Kimber-*

lin (1967) expanded on this idea. It was the former who recognized four groups (labeled with Roman numerals I–IV) in order of decreasing Ga and Ge concentrations. These elements are the most volatile siderophile elements and tend to be strongly fractionated between groups (Wai and Wasson, 1977) by nebular processes. The widespread application of the chemical classification (e.g., Fig. 4) stems largely from the work of J. Wasson and coworkers, who have systematically analyzed and classified nearly every iron meteorite known over the last 30 years. These authors introduced letters to the Roman numerals (e.g., IA, IVB) and, with increasing numbers of analyses, recognized that some of these groups were not independent, leading to groups like IAB (a grouping of the former IA and IB). Currently, there are 13 recognized groups, although Wasson and Kallemeyn (2002) argued that IAB and III CD form a single group termed the IAB complex. While the geochemical differences between the groups owe their existence to nebular processes, the geochemical trends within 10 of these groups are consistent with fractional crystallization, with each group forming in the core of a separate asteroid (Scott, 1972). The geochemical trends in IAB, III CD, and IIE irons differ substantially and have been the subject of intense debate, with suggested origins including crystallization of a S-rich core (Kracher, 1982), partial asteroidal differentiation followed by impact mixing (Benedix et al., 2000), and formation in isolated impact melt pools (Wasson and Kallemeyn, 2002). These groups are also noteworthy in containing silicate inclusions best described as primitive achondritic. In the case of IIE irons, silicates in some members (e.g., Netschaëvo) have strong similarities to H chondrites. The term “nonmagmatic” has been widely applied to IAB, III CD, and IIE irons, stemming from the 1970s-era belief that these meteorites could not have formed from melts. This idea has been fully refuted and the term should be discarded.

Although the geochemical classification has largely supplanted the older structural classification, owing largely to the lack of practitioners of the latter, it is noteworthy that the two often correlate and the geochemical classification of many meteorites can be inferred from the structure, including the IVA irons (fine octahedrites), the IIAB irons (coarse octahedrites), and many IAB irons (medium octahedrites often with silicate inclusions). This overlap primarily reflects the control of geochemistry (particularly bulk Ni concentration) on the growth of the Widmanstätten structure.

Finally, about 15% of all iron meteorites do not fit into the well-described groups. This percentage increases to about 40% in the Antarctic meteorites (Wasson, 1990), where smaller sample masses may more closely reflect the true rate of incoming material. The origin of these meteorites is not well understood. Some may represent extreme fractional crystallization products of well-known groups and others could be impact melt products. However, some may represent the only sample of an asteroid. Wasson (1990)

estimated that 30–50 asteroids may be represented in the ungrouped irons and it is significant to note that this may be as many as all other groups of meteorites combined (Burbine et al., 2002).

8. SYNTHESIS

8.1. Alternative Scheme for Meteorite Classification

Comparison of the mineralogical-petrological properties with O-isotopic compositions of meteorites has revealed a number of interesting relationships. Some meteorites with differing petrologic and whole-chondrite chemical compositions have similar O-isotopic compositions. This has been interpreted to indicate derivation of these groups (or their components), which have grossly different petrographic features from the same local nebular reservoir or parent asteroid. For example, the CR, CH, and CB chondrites, which have very different chondrule sizes and textures and metal abundances, are considered part of the CR clan and may have formed from the same O-isotope reservoir. The howardites, eucrites, and diogenites (HEDs) are considered an association, largely because howardites are a physical mixture of eucritic and diogenitic clasts. Oxygen isotopes revealed a shared signature with main-group pallasites and IIIAB irons, suggesting a possible genetic relationship. Although this may indicate derivation from a common nebular reservoir, spectroscopic and dynamic studies that point to the intact, differentiated asteroid 4 Vesta as the parent of HEDs (McCord et al., 1970) would require a separate parent body or bodies for main-group pallasites and IIIAB irons.

On the other hand, some meteorites with strong petrologic similarity, suggesting group affiliation, plot in different regions of the O-isotope diagram, suggesting derivation from different O reservoirs. For example, Tafassasset and LEW 88763 are petrologically and chemically similar to the brachinites, but their O-isotopic compositions are far removed from the region in which most brachinites plot on the O three-isotope diagram (Nehru et al., 2003). Eagle Station pallasites, pyroxene pallasites, main-group pallasites, and the ungrouped pallasite Milton are petrologically similar, but their O-isotopic compositions differ dramatically (Plate 3), suggesting that they represent separate parent bodies and do not belong to the same group.

The disagreement between O-isotopic compositions and petrologic-chemical studies — both in terms of pointing to differences between petrologically similar materials and possibly between petrologically disparate materials — has produced most of the debate about the classificational structure over the last few decades. The classificational scheme illustrated in Fig. 1 stems largely from chemical-petrological studies, and perhaps only in the case of C chondrites and a few groups of achondrites (e.g., acapulcoite-lodranites vs. winonaites) do the O isotopes play a prominent role. It is possible to develop an entirely different classificational

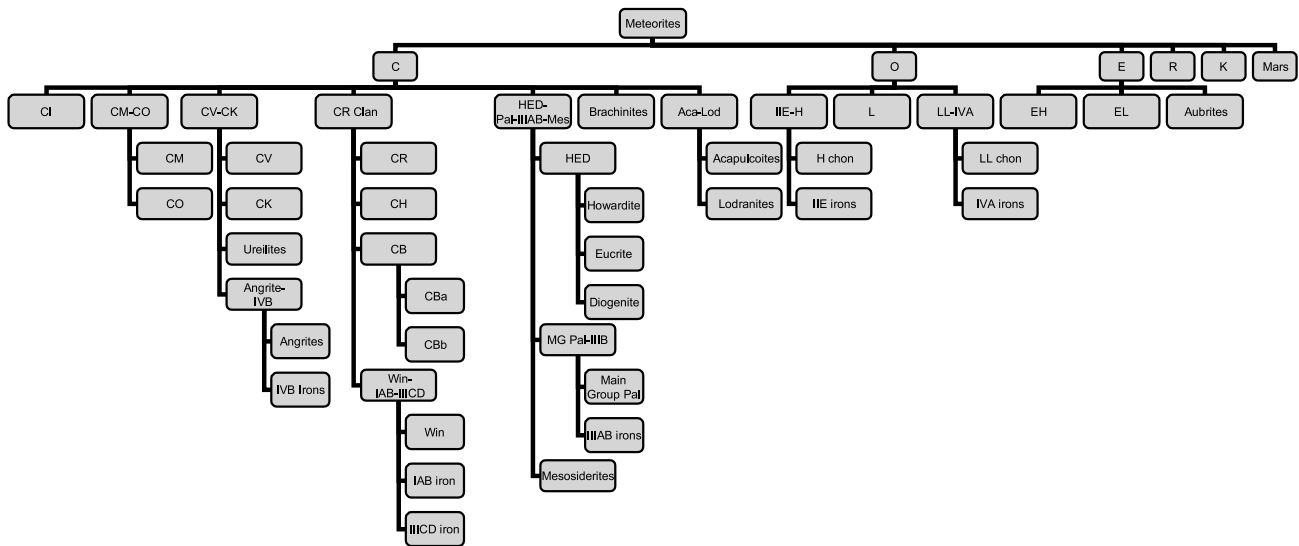

Fig. 8. Alternative classification scheme in which meteorites are linked by origins from common parent bodies or derivation from common nebular reservoirs. Some links are based on petrology, chemistry, and O-isotopic compositions (e.g., enstatite chondrites and aubrites), while in other cases, the link is based almost completely on O isotopes (e.g., IVA irons and LL chondrites). We note that this scheme is highly interpretive and is just one of a number of possibilities.

scheme and we illustrate one such scheme in Fig. 8. In such a scheme, meteorites are grouped to point out origins from common parent bodies or derivation from common nebular reservoirs or precursor materials. In this sense, we find groupings between chondrites and irons (e.g., IVA-LL, IIE-H), between achondrites and irons (e.g., angrites-IVB), and between chondrites and achondrites (CV-ureilites, EH-EL-aubrites). The problem with such a scheme is that it is highly interpretive. In some cases, links are based on petrology, chemistry, and O-isotopic compositions (e.g., E chondrites and aubrites), while in other cases the link rests almost completely on O isotopes (e.g., IVA irons and LL chondrites). In addition, it is unclear what, if anything, these links actually represent. In some cases, a common parent body may be indicated (e.g., angrites-IVB irons), while in others, the link may only reflect derivation of a particular achondrite or iron from a precursor similar, but not identical, to the known chondrite (e.g., EH-EL-aubrites). Such a diagram can provide some interesting insights, such as the apparent paucity of achondrites and irons apparently derived from the abundant O chondrites, while most achondrites and irons appear linked to C chondrites. Even in this case, care must be applied, since this may be essentially an artifact of defining meteorites below the terrestrial fractionation line as C chondrites. If such a simplistic link were applied to the terrestrial planets, Earth would be linked to E chondrites and aubrites, while Mars would derive from a yet-undiscovered chondrite more akin to O chondrites. Neither of these conclusions appears valid at this time. Given these uncertainties, and the ongoing debate about meteorite origins reflected in the remainder of this book, we find it unlikely that such

a classification scheme will supplant the more traditional version (Fig. 1) in the foreseeable future, although knowledge of the possible links is a key piece of information for any worker new to the field.

8.2. The Future of Classification

The evolution of meteorite classification necessitates a continuing influx of new samples and continuing efforts to determine their petrologic characteristics and bulk chemical and O-isotopic compositions. While classification schemes will continue to evolve, in both the groups of meteorites and the techniques used to classify them, one of the ultimate goals of classification is to put meteorites into geologic context. In many respects, most classification is simply an effort to deduce the kind of information that the terrestrial field geologist knows when they collect their samples (where the samples came from and what their spatial relationship was to the rocks around it). In the next few decades, it is quite possible that missions to asteroids, Mars, the Moon, and comets will allow us to place meteorites in geologic context and, ultimately, the goal should be to say this meteorite came from this asteroid/type or asteroid/family of asteroids.

Acknowledgments. Reviews by M. Grady, J. Grossman, and D. Lauretta and editorial handling by L. Leshin are greatly appreciated and led to major improvements in this chapter. This work was supported by NASA Grants NAG5-11546 (M.K.W., P.I.), NAG5-13464 (T.J.M., P.I.), NAG5-10610, NAG5-12882 (A.N.K., P.I.), and NAG5-11591 (K. Keil, P.I.). This is Hawai'i Institute of Geophysics and Planetology Publication No. 1424 and School of Ocean and Earth Science and Technology Publication No. 6709.

REFERENCES

- Aléon J., Krot A. N., and McKeegan K. D. (2002) Calcium-aluminum-rich inclusions and amoeboid olivine aggregates from the CR carbonaceous chondrites. *Meteoritics & Planet. Sci.*, *37*, 1729–1755.
- Akai J. (1988) Incompletely transformed serpentine-type phyllosilicates in the matrix of Antarctic CM chondrites. *Geochim. Cosmochim. Acta*, *52*, 1593–1599.
- Alexander C. M. O'D., Hutchison R., and Barber D. J. (1989) Origin of chondrule rims and interchondrule matrices in unequilibrated ordinary chondrites. *Earth Planet. Sci. Lett.*, *95*, 187–207.
- Anders E. and Grevesse N. (1989) Abundances of elements: Meteoritic and solar. *Geochim. Cosmochim. Acta*, *53*, 197–214.
- Anders E. and Zinner E. (1993) Interstellar grains in primitive meteorites: Diamond, silicon carbide, and graphite. *Meteoritics*, *28*, 490–514.
- Beckett J. R., Connolly H. C., and Ebel D. S. (2006) Chemical processes in calcium-aluminum-rich inclusions: A mostly CMAS view of melting and crystallization. In *Meteorites and the Early Solar System II* (D. S. Lauretta and H. Y. McSween Jr., eds.), this volume. Univ. of Arizona, Tucson.
- Benedix G. K., McCoy T. J., Keil K., Bogard D. D., and Garrison D. H. (1998) A petrologic and isotopic study of winonaite: Evidence for early partial melting, brecciation, and metamorphism. *Geochim. Cosmochim. Acta*, *62*, 2535–2553.
- Benedix G. K., McCoy T. J., Keil K., and Love S. G. (2000) A petrologic study of the IAB iron meteorites: Constraints on the formation of the IAB-winonaite parent body. *Meteoritics & Planet. Sci.*, *35*, 1127–1141.
- Bernatowicz T. J. and Zinner E. (1997) *Astrophysical Implications of the Laboratory Study of Presolar Materials*. American Institute of Physics, New York. 750 pp.
- Binzel R.P. and Xu S. (1993) Chips off of asteroid 4 Vesta: Evidence for the parent body of basaltic achondrite meteorites. *Science*, *260*, 186–191.
- Bischoff A. and Metzler K. (1991) Mineralogy and petrography of the anomalous carbonaceous chondrites Yamato-86720, Yamato-82162, and Belgica-7904. *Proc. NIPR Symp. Antarct. Meteorites*, *4*, 226–246.
- Bischoff A., Palme H., Ash R. D., Clayton R. N., Schultz L., Hergers U., Stöffler D., Grady M. M., Pillinger C. T., Spettel B., Weber H., Grund T., Endreß M., and Weber D. (1993a) Paired Renazzo-type (CR) carbonaceous chondrites from the Sahara. *Geochim. Cosmochim. Acta*, *57*, 1587–1603.
- Bischoff A., Palme H., Schultz L., Weber D., Weber H., and Spettel B. (1993b) Acfer 182 and paired samples, an iron-rich carbonaceous chondrite: Similarities with ALH85085 and relationship to CR chondrites. *Geochim. Cosmochim. Acta*, *57*, 2631–2648.
- Bischoff A., Geiger T., Palme H., Spettel B., Schultz L., Scherer P., Loeken T., Bland P., Clayton R. N., Mayeda T. K., Hergers U., Meltzow B., Michel R., and Dittrich-Hannen B. (1994) Acfer 217; a new member of the Rumuruti chondrite group (R). *Meteoritics*, *29*, 264–274.
- Bischoff A., Scott E. R. D., Metzler K., and Goodrich C. A. (2006) Nature and origins of meteoritic breccias. In *Meteorites and the Early Solar System II* (D. S. Lauretta and H. Y. McSween Jr., eds.), this volume. Univ. of Arizona, Tucson.
- Boesenberg J. S., Prinz M., Weisberg M. K., Davis A. M., Clayton R. N., Mayeda T. K., and Wasson J. T. (1995) Pyroxene-pallasites: A new pallasite grouplet (abstract). *Meteoritics*, *30*, 488–489.
- Bogard D. D. and Johnson P. (1983) Martian gases in an Antarctic meteorite. *Science*, *221*, 651–654.
- Bourot-Denise M., Zanda B., and Javoy M. (2002) Tafassasset: An equilibrated CR chondrite (abstract). In *Lunar and Planetary Science XXXIII*, Abstract #1611. Lunar and Planetary Institute, Houston (CD-ROM).
- Bowman L. E., Spilde M. N., and Papike J. J. (1997) Automated energy dispersive spectrometer modal analysis applied to diogenites. *Meteoritics & Planet. Sci.*, *32*, 869–875.
- Brearley A. J. (1989) Nature and origin of matrix in the unique type 3 chondrite, Kakangari. *Geochim. Cosmochim. Acta*, *53*, 197–214.
- Brearley A. J. (1991) Mineralogical and chemical studies of matrix in the Adelaide meteorite, a unique carbonaceous chondrite with affinities to ALH A77307 (CO3) (abstract). In *Lunar and Planetary Science XXII*, pp. 133–134. Lunar and Planetary Institute, Houston.
- Brearley A. J. (1993) Matrix and fine-grained rims in the unequilibrated CO3 chondrite, ALHA77307: Origins and evidence for diverse, primitive nebular dust components. *Geochim. Cosmochim. Acta*, *57*, 1521–1550.
- Brearley A. J. (1995) Aqueous alteration and brecciation in Bells, an unusual, saponite-bearing, CM chondrite. *Geochim. Cosmochim. Acta*, *59*, 2291–2317.
- Brearley A. J. (1997) Phyllosilicates in the matrix of the unique carbonaceous chondrite, LEW 85332 and possible implications for the aqueous alteration of CI chondrites. *Meteoritics & Planet. Sci.*, *32*, 377–388.
- Brearley A. J. (2006) The action of water. In *Meteorites and the Early Solar System II* (D. S. Lauretta and H. Y. McSween Jr., eds.), this volume. Univ. of Arizona, Tucson.
- Brearley A. J. and Jones R. H. (1998) Chondritic meteorites. In *Planetary Materials* (J. J. Papike ed.), pp. 3-1 to 3-398. Reviews in Mineralogy, Vol. 36, Mineralogical Society of America.
- Brown P. G., Hildebrand A. R., Zolensky M. E., Grady M., Clayton R. N., Mayeda T. K., Tagliaferri E., Spalding R., MacRae N. D., Hoffman E. L., Mittlefehldt D. W., Wacker J. F., Bird J. A., Campbell M. D., Carpenter R., Gingerich H., Glatiotis M., Greiner E., Mazur M. J., McCausland P. J., Plotkin H., and Mazur T. R. (2000) The fall, recovery, orbit, and composition of the Tagish Lake meteorite: a new type of carbonaceous chondrite. *Science*, *290*, 320–325.
- Browning L. B., McSween H. Y. Jr., and Zolensky M. E. (1996) Correlated alteration effects in CM carbonaceous chondrites. *Geochim. Cosmochim. Acta*, *60*, 2621–2633.
- Burbine T. H., McCoy T. J., Meibom A., Gladman B., and Keil K. (2002) Meteoritic parent bodies: Their number and identification. In *Asteroids III* (W. F. Bottke Jr. et al., eds.), pp. 653–667. Univ. of Arizona, Tucson.
- Burrioni A. and Folco L. (2003) Frontier Mountains 93001: An igneous-textured member of the Acapulco-Lodran clan. *Meteoritics & Planet. Sci.*, *38*, A98.
- Buseck P. R. (1977) Pallasite meteorites mineralogy, petrology and geochemistry. *Geochim. Cosmochim. Acta*, *41*, 711–740.
- Campbell A. J. and Humayan M. (2005) The Tishomingo iron: Relationship to IVB irons, CR clan chondrites and angrites and implications for the origin of volatile-depleted iron meteorites (abstract). In *Lunar and Planetary Science XXXVI*, Abstract

- #2062. Lunar and Planetary Institute, Houston (CD-ROM).
- Campbell A. J., Humayun M., Krot A., and Keil K. (2001) Origin of zoned metal grains in the QUE 94411 chondrite. *Geochim. Cosmochim. Acta*, 65, 163–180.
- Campbell A. J., Humayun M., and Weisberg M. K. (2002) Siderophile element constraints on the formation of metal in the metal-rich chondrites Bencubbin, Gujba and Weatherford. *Geochim. Cosmochim. Acta*, 66, 647–660.
- Casanova I., Keil K., and Newsom H. E. (1993) Composition of metal in aubrites: Constraints on core formation. *Geochim. Cosmochim. Acta*, 57, 675–682.
- Chabot N. L. and Haack H. (2006) Evolution of asteroidal cores. In *Meteorites and the Early Solar System II* (D. S. Lauretta and H. Y. McSween Jr., eds.), this volume. Univ. of Arizona, Tucson.
- Choi B.-G., Quyang X., and Wasson J. T. (1995) Classification and origin of IAB and III CD iron meteorites. *Geochim. Cosmochim. Acta*, 59, 593–612.
- Clayton R. N. and Mayeda Y. K. (1988) Formation of ureilites by nebular processes. *Geochim. Cosmochim. Acta*, 52, 1313–1318.
- Clayton R. N. and Mayeda T. K. (1996) Oxygen-isotope studies of achondrites. *Geochim. Cosmochim. Acta*, 60, 1999–2018.
- Clayton R. N. and Mayeda T. K. (1999) Oxygen isotope studies of carbonaceous chondrites. *Geochim. Cosmochim. Acta*, 63, 2089–2104.
- Clayton R. N., Mayeda T. K., and Rubin A. E. (1984) Oxygen isotopic compositions of enstatite chondrites and aubrites. *Proc. Lunar Planet. Sci. Conf. 15th*, in *J. Geophys. Res.*, 89, C245–C249.
- Davis A. M. and Olsen E. J. (1991) Phosphates in pallasite meteorites as probes of mantle processes in small planetary bodies. *Nature*, 353, 637–640.
- Davis A. M., Grossman L., and Ganapathy R. (1977) Yes, Kakanigari is a unique chondrite. *Nature*, 265, 230–232.
- Davy R., Whitehead S. G., and Pitt G. (1978) The Adelaide meteorite. *Meteoritics*, 13, 121–139.
- Delaney J. S., Prinz M., and Takeda H. (1984) The polymict eucrites. *Proc. Lunar Planet. Sci. Conf. 15th*, in *J. Geophys. Res.*, 89, C251–C288.
- Ebel D. S. (2006) Condensation of rocky material in astrophysical environments. In *Meteorites and the Early Solar System II* (D. S. Lauretta and H. Y. McSween Jr., eds.), this volume. Univ. of Arizona, Tucson.
- Endress M. and Bischoff A. (1993) Mineralogy, degree of brecciation, and aqueous alteration of CI chondrites Orgueil, Ivuna, and Alais (abstract). *Meteoritics*, 28, 345–346.
- Endress M. and Bischoff A. (1996) Carbonates in CI chondrites: Clues to parent body evolution. *Geochim. Cosmochim. Acta*, 60, 489–507.
- Endress M., Zinner E., and Bischoff A. (1996) Early aqueous activity on primitive meteorite parent bodies. *Nature*, 379, 701–703.
- Farrington O. C. (1907) Analysis of iron meteorites, compiled and classified. *Field Columbian Museum Pub. 120, Geol. Ser. Vol. 3*, 59–110.
- Fedkin A. V. and Grossman L. (2006) The fayalite content of chondritic olivine: Obstacle to understanding the condensation of rocky material. In *Meteorites and the Early Solar System II* (D. S. Lauretta and H. Y. McSween Jr., eds.), this volume. Univ. of Arizona, Tucson.
- Fitzgerald M. J. and Jones J. B. (1977) Adekaide and Bench Crater — members of a new subgroup of the carbonaceous chondrites. *Meteoritics*, 12, 443–458.
- Floran R. J. (1978) Silicate petrography, classification, and origin of the mesosiderites: Review and new observations. *Proc. Lunar Planet. Sci. Conf. 9th*, pp. 1053–1081.
- Floran R. J., Caulfield J. B. D., Harlow G. E., and Prinz M. (1978) Impact origin for the Simondium, Pinnaroo, and Hainholz mesosiderites: Implications for impact processes beyond the Earth-Moon system. *Proc. Lunar Planet. Sci. Conf. 9th*, pp. 1083–1114.
- Fredriksson K. and Keil K. (1963) The light-dark structure in the Pantar and Kapoeta stone meteorites. *Geochim. Cosmochim. Acta*, 27, 717–739.
- Friedrich J. M., Wang M.-S., and Lipschutz M. E. (2002) Comparison of the trace element composition of Tagish Lake with other primitive carbonaceous chondrites. *Meteoritics & Planet. Sci.*, 37, 677–686.
- Goldberg E., Uchiyama A., and Brown H. (1951) The distribution of nickel, cobalt, gallium, palladium and gold in iron meteorites. *Geochim. Cosmochim. Acta*, 2, 1–25.
- Goodrich C. A. (1992) Ureilites: A critical review. *Meteoritics*, 27, 327–352.
- Goodrich C. A., Jones J. H., and Berkley J. L. (1987) Origin and evolution of the ureilite parent magmas: Multi-stage igneous activity on a large parent body. *Geochim. Cosmochim. Acta*, 51, 2255–2273.
- Goodrich C. A., Fioretti A. M., Tribaudino M., and Molin G. (2001) Primary trapped melt inclusions in olivine in the olivine-augite-orthopyroxene ureilite Hughes 009. *Geochim. Cosmochim. Acta*, 65, 621–652.
- Goodrich C. A., Krot A. E., Scott E. R. D., Taylor G. J., Fioretti A. M., and Keil K. (2002) Formation and evolution of the ureilite parent body and its offspring (abstract). In *Lunar and Planetary Science XXXIII*, Abstract #1379. Lunar and Planetary Institute, Houston (CD-ROM).
- Goodrich C. A., Scott E. R. D., Fioretti A. M. (2004) Ureilitic breccias: Clues to the petrologic structure and impact disruption of the ureilite parent body. *Chem. Erde*, 64, 283–327.
- Grady M. M., Verchovsky A. B., Franchi I. A., Wright I. P., and Pillinger C. T. (2002) Light element geochemistry of the Tagish Lake CI2 chondrite: Comparison with CI1 and CM2 meteorites. *Meteoritics & Planet. Sci.*, 37, 713–735.
- Greenwood R. C., Franchi I. A., and Pillinger C. T. (2002) Oxygen isotopes in CO3 chondrites (abstract). In *Lunar and Planetary Science XXXIII*, Abstract #1609. Lunar and Planetary Institute, Houston (CD-ROM).
- Greenwood R. C., Franchi I. A., Kearsley A. T., and Alard O. (2005) The relationship between CK and CV chondrites: A single parent body source (abstract). In *Lunar and Planetary Science XXXV*, Abstract #1664. Lunar and Planetary Institute, Houston (CD-ROM).
- Greshake A. (1997) The primitive matrix components of the unique carbonaceous chondrite Acfer 094; a TEM study. *Geochim. Cosmochim. Acta*, 61, 437–452.
- Greshake A., Krot A. N., Meibom A., Weisberg M. K., and Keil K. (2002) Heavily-hydrated matrix lumps in the CH and metal-rich chondrites QUE 94411 and Hammadah al Hamra 237. *Meteoritics & Planet. Sci.*, 37, 281–294.
- Grossman J. N. and Zipfel J. (2001) The Meteoritical Bulletin, No. 85. *Meteoritics & Planet. Sci.*, 36, A293–A322.
- Grossman J. N., Rubin A. E., and MacPherson (1988) ALH85085; a unique volatile-poor carbonaceous chondrite with possible

- implications for nebular fractionation processes. *Earth Planet. Sci. Lett.*, *91*, 33–54.
- Grossman J. N., MacPherson G. J., and Crozaz G. (1993) LEW 87223: A unique E chondrite with possible links to H chondrites (abstract). *Meteoritics*, *28*, 358.
- Guimon R. K., Symes S. J. K., Sears D. W. G., and Benoit P. H. (1995) Chemical and physical studies of type 3 chondrites XII: The metamorphic history of CV chondrites and their components. *Meteoritics & Planet. Sci.*, *30*, 704–714.
- Hewins R. H. (1983) Impact versus internal origins for mesosiderites. *Proc. Lunar Planet. Sci. Conf. 14th*, in *J. Geophys. Res.*, *88*, B257–B266.
- Hiroi T., Pieters C. M., Zolensky M. E., and Lipschutz M. E. (1993a) Evidence of thermal metamorphism on the C, G, B and F asteroids. *Science*, *261*, 1016–1018.
- Hiroi T., Bell J. F., Takeda H., and Pieters C. M. (1993b) Spectral comparison between olivine-rich asteroids and pallasites. *Proc. NIPR Symp. Antarct. Meteorites*, *6*, 234–245.
- Hiroi T., Pieters C. M., Zolensky M. E., and Prinz M. (1996) Reflectance spectra (UV–3 μm) of heated Ivuna (CI) meteorite and newly identified thermally metamorphosed CM chondrites (abstract). In *Lunar and Planetary Science XXVII*, pp. 551–552. Lunar and Planetary Institute, Houston.
- Huss G. R. and Hutcheon I. D. (1992) Abundant $^{26}\text{Mg}^*$ in Adelaide refractory inclusions (abstract). *Meteoritics*, *27*, 236.
- Huss G. R., Rubin A. E., and Grossman J. N. (2006) Thermal metamorphism in chondrites. In *Meteorites and the Early Solar System II* (D. S. Lauretta and H. Y. McSween Jr., eds.), this volume. Univ. of Arizona, Tucson.
- Hutcheon I. D. and Steele I. M. (1982) Refractory inclusions in the Adelaide chondrite (abstract). In *Lunar and Planetary Science XXXIII*, pp. 352–353. Lunar and Planetary Institute, Houston.
- Hutchison R. (2004) *Meteorites: A Petrologic, Chemical and Isotopic Synthesis*. Cambridge Univ., Cambridge.
- Hutchison R., Alexander C. M. O'D., and Barber D. J. (1987) The Semarkona meteorite: First recorded occurrence of smectite in an ordinary chondrite, and its implications. *Geochim. Cosmochim. Acta*, *31*, 1103–1106.
- Ikeda Y. (1992) An overview of the research consortium, “Antarctic carbonaceous chondrites with CI affinities, Yamato-86720, Yamato-82162, and Belgica-7904.” *Proc. NIPR Symp. Antarct. Meteorites*, *5*, 49–73.
- Ikeda Y. and Prinz M. (1993) Petrologic study of the Belgica 7904 carbonaceous chondrite: Hydrous alteration, thermal metamorphism, and relationship to CM and CI chondrites. *Geochim. Cosmochim. Acta*, *57*, 439–452.
- Ikeda Y. and Prinz M. (2000) Magmatic inclusions and felsic clasts in the Dar al Gani 319 polymict ureilite. *Meteoritics & Planet. Sci.*, *36*, 481–500.
- Ikeda Y., Prinz M., and Nehru C. E. (2000) Lithic and mineral clasts in the Dar al Gani (DAG) 319 polymict ureilite. *Antarct. Meteorit. Res.*, *13*, 177–221.
- Ivanov A. V. (1989) The meteorite Kaidun: Composition and history of formation. *Geokhimiya*, *2*, 259–266.
- Ivanova M. A., Taylor L. A., Clayton R. N., Mayeda T. K., Nazarov M. A., Brandstaetter F., and Kurat G. (2002) Dhofar 225 vs. the CM clan: Metamorphosed or new type of carbonaceous chondrite? (abstract). In *Lunar and Planetary Science XXXIII*, Abstract #1437. Lunar and Planetary Institute, Houston (CD-ROM).
- Jurewicz A. J. G., Mittlefehldt D. W., and Jones J. H. (1993) Experimental partial melting of the Allende (CV) and Murchison (CM) chondrites and the origin of asteroidal basalts. *Geochim. Cosmochim. Acta*, *57*, 2123–3139.
- Kallemeyn G. W. (1995) Bells and Essebi: To be or not to be (CM) (abstract). *Meteoritics*, *30*, 525–526.
- Kallemeyn G. W. (1996) The classificational wanderings of the Ningqiang chondrite (abstract). In *Lunar and Planetary Science XXVII*, pp. 635–636. Lunar and Planetary Institute, Houston.
- Kallemeyn G. W. and Rubin A. E. (1995) Coolidge and Loonagana 001: A new carbonaceous chondrite grouplet. *Meteoritics*, *30*, 20–27.
- Kallemeyn G. W. and Wasson J. T. (1981) The compositional classification of chondrites: I. The carbonaceous chondrite groups. *Geochim. Cosmochim. Acta*, *45*, 1217–1230.
- Kallemeyn G. W. and Wasson J. T. (1982) The compositional classification of chondrites: III. Ungrouped carbonaceous chondrites. *Geochim. Cosmochim. Acta*, *46*, 2217–2228.
- Kallemeyn G. W. and Wasson J. T. (1985) The compositional classification of chondrites: IV. Ungrouped chondritic meteorites and clasts. *Geochim. Cosmochim. Acta*, *49*, 261–270.
- Kallemeyn G. W., Boynton W. V., Willis J., and Wasson J. T. (1978) Formation of the Bencubbin polymict meteoritic breccia. *Geochim. Cosmochim. Acta*, *42*, 507–515.
- Kallemeyn G. W., Rubin A. E., Wang D., and Wasson J. T. (1989) Ordinary chondrites: Bulk compositions, classification, lithophile-element fractionations, and composition-petrographic type relationships. *Geochim. Cosmochim. Acta*, *53*, 2747–2767.
- Kallemeyn G. W., Rubin A. E., and Wasson J. T. (1991) The compositional classification of chondrites: V. The Karoonda (CK) group of carbonaceous chondrites. *Geochim. Cosmochim. Acta*, *55*, 881–892.
- Kallemeyn G. W., Rubin A. E., and Wasson J. T. (1994) The compositional classification of chondrites: VI. The CR carbonaceous chondrite group. *Geochim. Cosmochim. Acta*, *58*, 2873–2888.
- Kallemeyn G. W., Rubin A. E., and Wasson J. T. (1996) The compositional classification of chondrites: VII. The R chondrite group. *Geochim. Cosmochim. Acta*, *60*, 2243–2256.
- Keil K. (1968) Mineralogical and chemical relationships among enstatite chondrites. *J. Geophys. Res.*, *73*, 6945–6976.
- Keil K. (1989) Enstatite meteorites and their parent bodies. *Meteoritics*, *24*, 195–208.
- Keil K. and Brett R. (1974) Heideite, $(\text{Fe,Cr})_{1+x}(\text{Ti,Fe})_2\text{S}_4$, a new mineral in the Bustee enstatite achondrite. *Am. Mineral.*, *59*, 465–470.
- Keil K., Ntaflos Th., Taylor G. J., Brearley A. J., Newsom H. E., and Romig A. D. Jr. (1989) The Shallowater aubrite: Evidence for origin by planetesimal impacts. *Geochim. Cosmochim. Acta*, *53*, 3291–3307.
- Keller L. P. and Buseck P. R. (1990a) Matrix mineralogy of the Lance CO3 carbonaceous chondrite. *Geochim. Cosmochim. Acta*, *54*, 1155–1163.
- Keller L. P. and Buseck P. R. (1990b) Aqueous alteration in the Kaba CV3 carbonaceous chondrite. *Geochim. Cosmochim. Acta*, *54*, 2113–2120.
- Keller L. P., Thomas K. L., Clayton R. N., Mayeda T. K., DeHart J. M., and McKay D. S. (1994) Aqueous alteration of the Bali CV3 chondrite: Evidence from mineralogy, mineral chemistry, and oxygen isotopic compositions. *Geochim. Cosmochim. Acta*, *58*, 5589–5598.
- Kerridge J. F. (1985) Carbon, hydrogen, and nitrogen in carbona-

- ceous chondrites: Abundances and isotopic compositions in bulk samples. *Geochim. Cosmochim. Acta*, 49, 1707–1714.
- Kimura M., Tsuchiyama A., Fukuoka T., and Iimura Y. (1992) Antarctic primitive achondrites, Yamato-74025, -75300, and -75305: Their mineralogy, thermal history, and the relevance to winonaites. *Proc. NIPR Symp. Antarct. Meteorites*, 5, 165–190.
- Kimura M., Chen M., Yoshida Y., El Goresy A., and Ohtani E. (2003) Back transformation of high pressure phases in a shock melt vein of an H-chondrite during atmosphere passage: Implications for the survival of high-pressure phases after decompression. *Earth Planet. Sci. Lett.*, 217, 141–150.
- Kimura M., Weisberg M. K., Lin Y., Suzuki A., Ohtani E., and Okazaki R. (2005) Thermal history of enstatite chondrites from silica polymorphs. *Meteoritics & Planet. Sci.*, 40, 855–868.
- Kita N. T., Ikeda Y., Togashi S., Liu Y., Morishita Y., and Weisberg M. K. (2004) Origin of ureilites inferred from a SIMS oxygen isotopic and trace element study of clasts in the Dar al Gani 319 polymict ureilite. *Geochim. Cosmochim. Acta*, 68, 4213–4235.
- Koeberl C., Ntaflos T., Kurat G., and Chai C. F. (1987) Petrology and geochemistry of the Ningqiang (CV3) chondrite (abstract). In *Lunar and Planetary Science XVIII*, pp. 499–500. Lunar and Planetary Institute, Houston.
- Kracher A. (1982) Crystallization of a S-saturated melt, and the origin of the iron meteorite groups IAB and III CD. *Geophys. Res. Lett.*, 9, 412–415.
- Kracher A., Willis J., and Wasson J. T. (1980) Chemical classification of iron meteorites; IX. A new group (IIF), revision of IAB and III CD, and data on 57 additional irons. *Geochim. Cosmochim. Acta*, 44, 773–787.
- Krot A. N., Scott E. R. D., and Zolensky M. E. (1995) Mineralogical and chemical variations among CV3 chondrites and their components: Nebular and asteroidal processing. *Meteoritics*, 30, 748–775.
- Krot A. N., Petaev M. I., Scott E. R. D., Choi B.-G., Zolensky M. E., and Keil K. (1998) Progressive alteration in CV3 chondrites: More evidence for asteroidal alteration. *Meteoritics & Planet. Sci.*, 33, 1065–1085.
- Krot A. N., Weisberg M. K., Petaev M. I., Keil K., and Scott E. R. D. (2000a) High-temperature condensation signatures in Type I chondrules from CR carbonaceous chondrites (abstract). In *Lunar and Planetary Science XXXI*, Abstract #1470. Lunar and Planetary Institute, Houston (CD-ROM).
- Krot A. N., Meibom A., and Keil K. (2000b) Volatile-poor chondrules in CH carbonaceous chondrites: Formation at high ambient nebular temperature (abstract). In *Lunar and Planetary Science XXXI*, Abstract #1481. Lunar and Planetary Institute, Houston (CD-ROM).
- Krot A. N., Meibom A., and Keil K. (2000c) A clast of Bali-like oxidized CV3 material in the reduced CV3 chondrite breccia Vigarano. *Meteoritics & Planet. Sci.*, 35, 817–827.
- Krot A. N., McKeegan K. D., Russell S. S., Meibom A., Weisberg M. K., Zipfel J., Krot T. V., Fagan T. J., and Keil K. (2001a) Refractory Ca,Al-rich inclusions and Al-diopside-rich chondrules in the metal-rich chondrites Hammadah al Hamra 237 and QUE 94411. *Meteoritics & Planet. Sci.*, 36, 1189–1217.
- Krot A. N., Huss G. R., and Hutcheon I. D. (2001b) Corundum-hibonite refractory inclusions from Adelaide: Condensation or crystallization from melt? (abstract). *Meteoritics & Planet. Sci.*, 36, A105.
- Krot A. N., Hutcheon I. D., and Huss G. R. (2001c) Aluminum-rich chondrules and associated refractory inclusions in the unique carbonaceous chondrite Adelaide (abstract). *Meteoritics & Planet. Sci.*, 36, A105–A106.
- Krot A. N., Aleon J., and McKeegan K. D. (2002a) Mineralogy, petrography and oxygen-isotopic compositions of Ca,Al-rich inclusions and amoeboid olivine aggregates in the CR carbonaceous chondrites (abstract). In *Lunar and Planetary Science XXXIII*, Abstract #1412. Lunar and Planetary Institute, Houston (CD-ROM).
- Krot A. N., Meibom A., Weisberg M. K., and Keil K. (2002b) The CR chondrite clan: Implications for early solar system processes. *Meteoritics & Planet. Sci.*, 37, 1451–1490.
- Krot A. N., Petaev M. I., and Bland P. A. (2003) Growth of ferrous olivine in the oxidized CV chondrites during fluid-assisted thermal metamorphism (abstract). *Meteoritics & Planet. Sci.*, 38, A73.
- Krot A. N., Keil K., Goodrich C. A., Scott E. R. D., and Weisberg M. K. (2004) Classification of Meteorites. In *Treatise on Geochemistry, Vol. 1: Meteorites, Comets, and Planets* (A. M. Davis, ed.), pp. 83–128. Elsevier, Oxford.
- Krot A. E., Hutcheon I. D., Brearley A. J., Pravdivtseva O. V., Petaev M. I., and Hohenberg C. M. (2006) Timescales and settings for alteration of chondritic meteorites. In *Meteorites and the Early Solar System II* (D. S. Lauretta and H. Y. McSween Jr., eds.), this volume. Univ. of Arizona, Tucson.
- Kung C. C. and Clayton R. N. (1978) Nitrogen abundances and isotopic compositions in stony meteorites. *Earth Planet. Sci. Lett.*, 38, 421–435.
- Kurat G. (1988) Primitive meteorites: An attempt toward unification. *Philos. Trans. R. Soc. London*, A325, 459–482.
- Lauretta D. S., Nagahara H., and Alexander C. M. O'D. (2006) Petrology and origin of ferromagnesian silicate chondrules. In *Meteorites and the Early Solar System II* (D. S. Lauretta and H. Y. McSween Jr., eds.), this volume. Univ. of Arizona, Tucson.
- Leshin L. A., Rubin A. E., and McKeegan K. D. (1997) The oxygen isotopic composition of olivine and pyroxene from CI chondrites. *Geochim. Cosmochim. Acta*, 61, 835–845.
- Lin Y. and El Goresy A. (2002) A comparative study of opaque phases in Qingzhen (EH3) and MacAlpine Hills 88136 (EL3): Representatives of EH and EL parent bodies. *Meteoritics & Planet. Sci.*, 37, 577–599.
- Lin Y. and Kimura M. (1998) Petrographic and mineralogical study of new EH melt rocks and a new enstatite chondrite grouplet. *Meteoritics & Planet. Sci.*, 33, 501–511.
- Lovering J. F. (1962) The evolution of the meteorites — Evidence for the co-existence of chondritic, achondritic and iron meteorites in a typical parent meteorite body. In *Researches on Meteorites* (C. B. Moore, ed.), pp. 179–197. Wiley, New York.
- Lovering J. F., Nichiporuk W., Chodos A., and Brown H. (1957) The distribution of gallium, germanium, cobalt, chromium, and copper in iron and stony-iron meteorites in relation to Ni content and structure. *Geochim. Cosmochim. Acta*, 11, 263–278.
- Marti K., Kim J. S., Thakur A. N., McCoy T. J., and Keil K. (1995) Signatures of the martian atmosphere in glass of the Zagami meteorite. *Science*, 267, 1981–1984.
- Mason B. (1967) Meteorites. *Am. Sci.*, 55, 429–455.
- Mason B. and Nelen J. (1968) The Weatherford meteorite. *Geochim. Cosmochim. Acta*, 32, 661–664.
- Mayeda K., Clayton R. N., Krung D. A., and Davis A. M. (1988) Oxygen, silicon and magnesium isotopes in Ningqiang chondrules (abstract). *Meteoritics*, 23, 288.
- McCoy T. J. and Carlson W. D. (1998) Opaque minerals in the GRA 95209 lodranite: A snapshot of metal segregation (abstract). In *Lunar and Planetary Science XXIX*, Abstract #1675. Lunar and Planetary Institute, Houston (CD-ROM).

- McCoy T. J., Scott E. R. D., and Haack H. (1993) Genesis of the IICD iron meteorites: Evidence from silicate-bearing inclusions. *Meteoritics*, 28, 552–560.
- McCoy T. J., Keil K., Scott E. R. D., Benedix G. K., Ehlmann A. J., Mayeda T. K., and Clayton R. N. (1994) Low FeO ordinary chondrites: A nebular origin and a new chondrite parent body (abstract). In *Lunar and Planetary Science XXV*, pp. 865–866. Lunar and Planetary Institute, Houston.
- McCoy T. J., Keil K., Bogard D. D., Garrison D. H., Casanova I., Lindstrom M. M., Brearley A. J., Kehm K., Nichols R. H. Jr., and Hohenberg C. M. (1995) Origin and history of impact-melt rocks of enstatite chondrite parentage. *Geochim. Cosmochim. Acta*, 59, 161–175.
- McCoy T. J., Keil K., Clayton R. N., Mayeda T. K., Bogard D. D., Garrison D. H., Huss G. R., Hutcheon I. D., and Wieler R. (1996) A petrologic, chemical and isotopic study of Monument Draw and comparison with other acapulcoites: Evidence for formation by incipient partial melting. *Geochim. Cosmochim. Acta*, 60, 2681–2708.
- McCoy T. J., Keil K., Clayton R. N., Mayeda T. K., Bogard D. D., Garrison D. H., and Wieler R. (1997a) A petrologic and isotopic study of lodranites: Evidence for early formation as partial melt residues from heterogeneous precursors. *Geochim. Cosmochim. Acta*, 61, 623–637.
- McCoy T. J., Keil K., Muenow D. W., and Wilson L. (1997b) Partial melting and melt migration in the acapulcoite-lodranite parent body. *Geochim. Cosmochim. Acta*, 61, 639–650.
- McCoy T. J., Mittlefehldt D. W., and Wilson L. (2006) Asteroid differentiation. In *Meteorites and the Early Solar System II* (D. S. Lauretta and H. Y. McSween Jr., eds.), this volume. Univ. of Arizona, Tucson.
- McCord T. B., Adams J. B., and Johnson T. V. (1970) Asteroid Vesta: Spectral reflectivity and compositional implications. *Science*, 168, 1445–1447.
- McKay D. S., Gibson E. K., Thomas-Keptra, Vali H., Romanek C. S., Clement S. J., Chillier X. D. F., Maechling C. R., and Zare R. N. (1996) Search for past life on Mars: Possible relic biogenic activity in martian meteorite ALH84001. *Science*, 273, 924–930.
- McKay G., Lindstrom D., Yang S-R., and Wagstaff J. (1988) Petrology of a unique achondrite Lewis Cliff 86010 (abstract). In *Lunar and Planetary Science XIX*, pp. 762–763. Lunar and Planetary Institute, Houston.
- McKay G., Crozaz G., Wagstaff J., Yang S-R., and Lundberg L. (1990) A petrographic, electron microprobe, and ion microprobe study of mini-angrite Lewis Cliff 87051 (abstract). In *Lunar and Planetary Science XXI*, pp. 771–772. Lunar and Planetary Institute, Houston.
- McSween H. Y. Jr. (1977a) Carbonaceous chondrites of the Ornanis type: A metamorphic sequence. *Geochim. Cosmochim. Acta*, 41, 479–491.
- McSween H. Y. Jr. (1977b) Petrographic variations among carbonaceous chondrites of the Vigarano type. *Geochim. Cosmochim. Acta*, 41, 1777–1790.
- McSween H. Y. Jr. (1979) Are carbonaceous chondrites primitive or processed? A review. *Rev. Geophys. Space Phys.*, 17, 1059–1078.
- McSween H. Y. Jr. (2002) The rocks of Mars, from far and near. *Meteoritics & Planet. Sci.*, 37, 7–25.
- McSween H. Y. Jr. and Richardson S. M. (1977) The composition of carbonaceous chondrite matrix. *Geochim. Cosmochim. Acta*, 41, 1145–1161.
- McSween H. Y. Jr. and Treiman A. H. (1998) Martian meteorites. In *Planetary Materials* (J. J. Papike ed.), pp. 6-1 to 6-53. Reviews in Mineralogy, Vol. 36, Mineralogical Society of America.
- Meibom A., Petaev M. I., Krot A. N., Wood J. A., and Keil K. (1999) Primitive Fe,Ni metal grains in CH carbonaceous chondrites formed by condensation from a gas of solar composition. *J. Geophys. Res.*, 104, 22053–22059.
- Meibom A., Desch S. J., Krot A. N., Cuzzi J. N., Petaev M. I., Wilson L., and Keil K. (2000a) Large scale thermal events in the solar nebula recorded in Fe, Ni metal condensates in primitive meteorites. *Science*, 288, 839–841.
- Meibom A., Krot A. N., Righter K., Chabot N., and Keil K. (2000b) Metal/sulfide-ferrous silicate shock melts in QUE 94411 and Hammadah al Hamra 237: Remains of the missing matrix? (abstract). In *Lunar and Planetary Science XXXI*, Abstract #1420. Lunar and Planetary Institute, Houston (CD-ROM).
- Meibom A., Petaev M. I., Krot A. N., Keil K., and Wood J. A. (2001) Growth mechanism and additional constraints on FeNi metal condensation in the solar nebula. *J. Geophys. Res.*, 106, 32797–32801.
- Mittlefehldt D. W. (1994) ALH84001, a cumulate orthopyroxenite member of the martian meteorite clan. *Meteoritics*, 29, 214–221.
- Mittlefehldt D. W. (2002) Geochemistry of the ungrouped carbonaceous chondrite Tagish Lake, the anomalous CM chondrite Bells, and comparison with CI and CM chondrites. *Meteoritics & Planet. Sci.*, 37, 703–712.
- Mittlefehldt D. W. (2004) Achondrites. In *Treatise on Geochemistry, Vol. 1: Meteorites, Comets, and Planets* (A. M. Davis, ed.), pp. 291–324. Elsevier, Oxford.
- Mittlefehldt D. W. and Lindstrom M. M. (1998) Petrology and geochemistry of lodranite GRA 95209 (abstract). *Meteoritics & Planet. Sci.*, 33, A111.
- Mittlefehldt D. W., Lindstrom M. M., Bogard D. D., Garrison D. H., and Field S. W. (1996) Acapulco- and Lodran-like achondrites: Petrology, geochemistry, chronology and origin. *Geochim. Cosmochim. Acta*, 60, 867–882.
- Mittlefehldt D. W., McCoy T. J., Goodrich C. A., and Kracher A. (1998) Non-chondritic meteorites from asteroidal bodies. In *Planetary Materials* (J. J. Papike, ed.), pp. 4-1 to 4-495. Reviews in Mineralogy, Vol. 36, Mineralogical Society of America.
- Nagahara H. (1992) Yamato-8002: Partial melting residue on the “unique” chondrite parent body. *Proc. NIPR Symp. Antarct. Meteorites*, 5, 191–223.
- Nehru C. E., Prinz M., Weisberg M. K., Ebihara M. E., Clayton R. E., and Mayeda T. K. (1996) Brachinites: A new primitive achondrite group (abstract). *Meteoritics*, 27, 267.
- Nehru C. E., Weisberg M. K., Boesenberg J. S., and Kilgore M. (2003) Tafassasset: A metal-rich primitive achondrite with affinities to brachinites (abstract). In *Lunar and Planetary Science XXXIV*, Abstract #1370. Lunar and Planetary Institute, Houston (CD-ROM).
- Newsom H. E. and Drake M. J. (1979) The origin of metal clasts in the Bencubbin meteoritic breccia. *Geochim. Cosmochim. Acta*, 43, 689–707.
- Newton J., Bischoff A., Arden J. W., Franci I. A., Geiger T., Greshake A., and Pillinger C. T. (1995) Acfer 094, a uniquely primitive carbonaceous chondrite from the Sagara. *Meteoritics*, 30, 47–56.
- Noguchi T. (1994) Petrology and mineralogy of the Coolidge meteorite (CV4). *Proc. NIPR Symp. Antarct. Meteorites*, 7, 42–72.

- Nyquist L. E., Bogard D. D., Shih C.-Y., Greshake A., Stöffler D., and Eugster O. (2001) Ages and geologic histories of martian meteorites. *Space Sci. Rev.*, *96*, 105–164.
- Olsen E., Bunch T. E., Jarosewich E., Noonan A. F., and Huss G. I. (1977) Happy Canyon: A new type of enstatite chondrite. *Meteoritics*, *12*, 109–123.
- Palme H., Hutcheon I. D., Kennedy A. K., Sheng Y. J., and Spettel B. (1991) Trace element distributions in minerals from a silicate inclusion in the Caddo IAB-iron meteorite (abstract). In *Lunar and Planetary Science XXII*, pp. 1015–1016. Lunar and Planetary Institute, Houston.
- Papike J. J. (1998) Comparative planetary mineralogy: Chemistry of melt-derived pyroxene, feldspar, and olivine. In *Planetary Materials* (J. J. Papike, ed.), pp. 7-1 to 7-11. Reviews in Mineralogy, Vol. 36, Mineralogical Society of America.
- Papike J. J., Ryder G., and Shearer C. K. (1998) Lunar samples. In *Planetary Materials* (J. J. Papike, ed.), pp. 5-1 to 5-234. Reviews in Mineralogy, Vol. 36, Mineralogical Society of America.
- Patzer A., Hill D. H., and Boynton W. V. (2001) Itqiy: A metal-rich enstatite meteorite with achondritic texture. *Meteoritics & Planet. Sci.*, *36*, 1495–1505.
- Paul R. L. and Lipschutz M. E. (1990) Consortium study of labile trace elements in some Antarctic carbonaceous chondrites: Antarctic and non-Antarctic meteorite comparisons. *Proc. NIPR Symp. Antarct. Meteorites*, *3*, 80–95.
- Petaev M. I., Clarke R. S. Jr., Olsen E. J., Jarosewich E., Davis A. M., Steele I. M., Litschutz M. E., Wang M.-S., Clayton R. N., Mayeda T. K., and Wood J. A. (1993) Chaunskij: The most highly metamorphosed, shock-modified and metal-rich mesosiderite (abstract). In *Lunar and Planetary Science XXIV*, pp. 1131–1132. Lunar and Planetary Institute, Houston.
- Petaev M. I., Meibom A., Krot A. N., Wood J. A., and Keil K. (2001) The condensation origin of zoned metal grains in Queen Alexandra Range 94411: Implications for the formation of the Bencubbin-like chondrites. *Meteoritics & Planet. Sci.*, *36*, 93–106.
- Prinz M., Keil K., Hlava P. F., Berkley J. L., Gomes C. B., and Curvello W. S. (1977) Studies of Brazilian meteorites, III. Origin and history of the Angra dos Reis achondrite. *Earth Planet. Sci. Lett.*, *35*, 317–330.
- Prinz M., Nehru C. E., Delaney J. S., and Weisberg M. (1983) Silicates in IAB and IIICD irons, winonaites, lodranites and Brachina: A primitive and modified primitive group (abstract). In *Lunar and Planetary Science XIV*, pp. 616–617. Lunar and Planetary Institute, Houston.
- Prinz M., Chatterjee N., Weisberg M. K., Clayton R. N., and Mayeda T. K. (1991) Lea County 002: A second Kakangari-type chondrite (abstract). In *Lunar and Planetary Science XXII*, pp. 1097–1098. Lunar and Planetary Institute, Houston.
- Prinz M., Weisberg M. K., Brearley A., Grady M. M., Pillinger C. T., Clayton R. N., and Mayeda T. K. (1992) LEW85332: a C2 chondrite in the CR clan (abstract). *Meteoritics*, *27*, 278–279.
- Prior G. T. (1920) The classification of meteorites. *Mineral. Mag.*, *19*, 51–63.
- Rowe M. W., Clayton R. N., and Mayeda T. K. (1994) Oxygen isotopes in separated components of CI and CM chondrites. *Geochim. Cosmochim. Acta*, *58*, 5341–5347.
- Rubin A. E. (1989) Size-frequency distributions of chondrules in CO3 chondrites. *Meteoritics*, *24*, 179–189.
- Rubin A. E. (1990) Kamacite and olivine in ordinary chondrites: Intergroup and intragroup relationships. *Geochim. Cosmochim. Acta*, *54*, 1217–1232.
- Rubin A. E. (1998) Correlated petrologic and geochemical characteristics of CO3 chondrites. *Meteoritics & Planet. Sci.*, *33*, 385–391.
- Rubin A. E. and Kallemeyn G. W. (1990) Lewis Cliff 85332: A unique carbonaceous chondrite. *Meteoritics*, *25*, 215–225.
- Rubin A. E. and Kallemeyn G. W. (1994) Pecora Escarpment 91002; a member of the Rumuruti (R) chondrite group. *Meteoritics*, *29*, 255–264.
- Rubin A. E. and Scott E. R. D. (1997) Abee and related EH chondrite impact-melt breccias. *Geochim. Cosmochim. Acta*, *61*, 425–435.
- Rubin A. E., James J. A., Keck B. D., Weeks K. S., Sears D. W. G., and Jarosewich E. (1985) The Colony meteorite and variations in CO3 chondrite properties. *Meteoritics*, *20*, 175–197.
- Rubin A. E., Wang D., Kallemeyn G. W., and Wasson J. T. (1988) The Ningqiang meteorite; classification and petrology of an anomalous CV chondrite. *Meteoritics*, *23*, 13–23.
- Rubin A. E., Keil K., and Scott E. R. D. (1997) Shock metamorphism of enstatite chondrites. *Geochim. Cosmochim. Acta*, *61*, 847–858.
- Rubin A. E., Kallemeyn G. W., Wasson J. T., Clayton R. N., Mayeda T. K., Grady M. M., and Verchovsky A. B. (2001) Cujba: A new Bencubbin-like meteorite fall from Nigeria (abstract). In *Lunar and Planetary Science XXXII*, Abstract #1779. Lunar and Planetary Institute, Houston (CD-ROM).
- Russell S. S. (1998) A survey of calcium-aluminum-rich inclusions from Rumuruti chondrites: Implications for relationships between meteorite groups (abstract). *Meteoritics & Planet. Sci.*, *33*, A131–A132.
- Russell S. S., Huss G. R., Fahey A. J., Greenwood R. C., Hutchinson R., and Wasserburg G. J. (1998a) An isotopic and petrologic study of calcium-aluminum-rich inclusions from CO3 chondrites. *Geochim. Cosmochim. Acta*, *62*, 689–714.
- Russell S. S., McCoy T. J., Jarosewich E., and Ash R. D. (1998b) The Burnwell, Kentucky, low iron oxide chondrite fall: Description, classification and origin. *Meteoritics & Planet. Sci.*, *33*, 853–856.
- Schulze H., Bischoff A., Palme H., Spettel B., Dreibus G., and Otto J. (1994) Mineralogy and chemistry of Rumuruti: The first meteorite fall of the new R chondrite group. *Meteoritics & Planet. Sci.*, *29*, 275–286.
- Shultz L., Palme H., Spettel B., Weber H. W., Wänke H., Christophe Michel-Levy., and Lorin J. C. (1982) Allan Hills A77081 — An unusual stony meteorite. *Earth Planet. Sci. Lett.*, *61*, 23–31.
- Scott E. R. D. (1972) Chemical fractionation in iron meteorites and its interpretation. *Geochim. Cosmochim. Acta*, *36*, 1205–1236.
- Scott E. R. D. (1977) Geochemical relationship between some pallasites and iron meteorites. *Mineral. Mag.*, *41*, 262–275.
- Scott E. R. D. (1988) A new kind of primitive chondrite, Allan Hills 85085. *Earth Planet. Sci. Lett.*, *91*, 1–18.
- Scott E. R. D. and Jones R. H. (1990) Disentangling nebular and asteroidal features of CO3 carbonaceous chondrites. *Geochim. Cosmochim. Acta*, *54*, 2485–2502.
- Scott E. R. D. and Taylor G. J. (1985) Petrology of types 4–6 carbonaceous chondrites. *Proc. Lunar Planet. Sci. Conf. 15th*, in *J. Geophys. Res.*, *90*, C699–C709.

- Scott E. R. D. and Wasson J. T. (1975) Classification and properties of iron meteorites. *Rev. Geophys. Space Phys.*, 13, 527–546.
- Scott E. R. D., Taylor G. J., Maggiore P., Keil K., McKinley S. G., and McSween H. Y. Jr. (1981) Three CO3 chondrites from Antarctica; comparison of carbonaceous and ordinary type 3 chondrites (abstract). *Meteoritics*, 16, 385.
- Scott E. R. D., Taylor G. J., and Keil K. (1993) Origin of ureilite meteorites and implications for planetary accretion. *Geophys. Res. Lett.*, 20, 415–418.
- Scott E. R. D., Haack H., and Love S. G. (2001) Formation of mesosiderites by fragmentation and reaccretion of a large differentiated asteroid. *Meteoritics & Planet. Sci.*, 36, 869–881.
- Sears D. W. G. and Dodd R. T. (1988) Overview and classification of meteorites. In *Meteorites and the Early Solar System* (J. F. Kerridge and M. S. Matthews, eds.), pp. 3–31. Univ. of Arizona, Tucson.
- Sears D. W. G. and Ross M. (1983) Classification of the Allan Hills A77307 meteorite. *Meteoritics*, 18, 1–7.
- Sears D. W. G. and Weeks K. S. (1991) Chemical and physical studies of type 3 chondrites: 2. Thermoluminescence of sixteen type 3 ordinary chondrites and relationships with oxygen isotopes. *Proc. Lunar Planet. Sci. Conf. 14th*, in *J. Geophys. Res.*, 88, B301–B311.
- Sears D. W. G., Grossman J. N., Melcher C. L., Ross L. M., and Mills A. A. (1980) Measuring the metamorphic history of unequilibrated ordinary chondrites. *Nature*, 287, 791–795.
- Sears D. W. G., Kallemeyn G. W., and Wasson J. T. (1982) The compositional classification of chondrites: II. The enstatite chondrite groups. *Geochim. Cosmochim. Acta*, 46, 597–608.
- Sears D. W. G., Hasan F. A., Batchelor J. D., and Lu J. (1991) Chemical and physical studies of type 3 chondrites; XI. Metamorphism, pairing, and brecciation of ordinary chondrites. *Proc. Lunar Planet. Sci.*, Vol. 22, pp. 493–512.
- Srinivasan B. and Anders E. (1977) Noble gases in the unique chondrite, Kakangari. *Meteoritics*, 12, 417–424.
- Stöffler D., Keil K., and Scott E. R. D. (1991) Shock metamorphism in ordinary chondrites. *Geochim. Cosmochim. Acta*, 55, 3845–3867.
- Takeda H. (1987) Mineralogy of Antarctic ureilites and a working hypothesis for their origin and evolution. *Earth Planet. Sci. Lett.*, 81, 358–370.
- Takeda H., Mori H., Hiroi T., and Saito J. (1994) Mineralogy of new Antarctic achondrites with affinity to Lodran and a model of their evolution in an asteroid. *Meteoritics*, 29, 830–842.
- Takeda H., Yugami K., Bogard D. D., and Miyamoto M. (1997) Plagioclase-augite-rich gabbro in the Caddo County IAB iron and the missing basalts associated with iron meteorites. In *Lunar and Planetary Science XXVIII*, pp. 1409–1410. Lunar and Planetary Institute, Houston.
- Tomeoka K. (1990) Mineralogy and petrology of Belgica-7904: A new kind of carbonaceous chondrite from Antarctica. *Proc. NIPR Symp. Antarct. Meteorites*, 3, 40–54.
- Tomeoka K. and Buseck P. R. (1990) Phyllosilicates in the Mokoia CV carbonaceous chondrite: Evidence for aqueous alteration in an oxidizing condition. *Geochim. Cosmochim. Acta*, 54, 1745–1754.
- Tomeoka K., Kojima H., and Yanai K. (1989) Yamato-86720: A CM carbonaceous chondrite having experienced extensive aqueous alteration and thermal metamorphism. *Proc. NIPR Symp. Antarct. Meteorites*, 2, 55–74.
- Tomeoka K., Nomura K., and Takeda H. (1992) Na-bearing Ca-Al-rich inclusions in the Yamato-791717 CO carbonaceous chondrite. *Meteoritics*, 27, 136–143.
- Van Schmus W. R. and Wood J. A. (1967) A chemical-petrologic classification for the chondritic meteorites. *Geochim. Cosmochim. Acta*, 31, 747–765.
- Wai C. M. and Wasson J. T. (1977) Nebular condensation of moderately volatile elements and their abundances in ordinary chondrites. *Earth. Planet. Sci. Lett.*, 36, 1–13.
- Warren P. H. and Kallemeyn G. W. (1989) Allan Hills 84025: The second brachinite, far more differentiated than Brachina, and an ultramafic achondritic clast from L chondrite Yamato 75097. *Proc. Lunar Planet. Sci. Conf. 19th*, pp. 475–486.
- Warren P. H. and Kallemeyn G. W. (1992) Explosive volcanism and the graphite-oxygen fugacity buffer on the parent asteroid(s) of the ureilite meteorites. *Icarus*, 100, 110–126.
- Wasson J. T. (1985) *Meteorites: Their Record of the Early Solar-System History*. Freeman, New York.
- Wasson J. T. (1990) Ungrouped iron meteorites in Antarctica: Origin of anomalously high abundance. *Science*, 249, 900–902.
- Wasson J. T. and Kallemeyn G. W. (1988) Composition of chondrites. *Philos. Trans. R. Soc. London*, A325, 535–544.
- Wasson J. T. and Kallemeyn G. W. (1990) Allan Hills 85085: A subchondritic meteorite of mixed nebular and regolithic heritage. *Earth Planet. Sci. Lett.*, 101, 148–161.
- Wasson J. T. and Kallemeyn G. W. (2002) The IAB iron-meteorite complex: A group, five subgroups, numerous grouplets, closely related, mainly formed by crystal segregation in rapidly cooling melts. *Geochim. Cosmochim. Acta*, 66, 2445–2473.
- Wasson J. T. and Kimberlin J. (1967) The chemical classification of iron meteorites; II, Irons and pallasites with germanium concentrations between 8 and 100 ppm. *Geochim. Cosmochim. Acta*, 31, 149–178.
- Wasson J. T., Rubin A. E., and Kallemeyn G. W. (1993) Reduction during metamorphism of four ordinary chondrites. *Geochim. Cosmochim. Acta*, 57, 1867–1869.
- Watters T.R. and Prinz M. (1979) Aubrites: Their origin and relationship to enstatite chondrites. *Proc. Lunar Planet. Sci. Conf. 10th*, pp. 1073–1093.
- Weisberg M. K. (2001) Sahara 00182, the first CR3 chondrite and formation of multi-layered chondrules (abstract). *Meteoritics & Planet. Sci.*, 36, A222–A223.
- Weisberg M. K. and Prinz M. (2000) The Grosvenor Mountains 95577 CR1 chondrite and hydration of the CR chondrites (abstract). *Meteoritics & Planet. Sci.*, 35, A168.
- Weisberg M. K., Prinz M., and Nehru C. E. (1988) Petrology of ALH85085: A chondrite with unique characteristics. *Earth Planet. Sci. Lett.*, 91, 19–32.
- Weisberg M. K., Prinz M., and Nehru C. E. (1990) The Bencubbin chondrite breccia and its relationship to CR chondrites and the ALH85085 chondrite. *Meteoritics*, 25, 269–279.
- Weisberg M. K., Prinz M., Kojima H., Yanai K., Clayton R. N., and Mayeda T. K. (1991) The Carlisle Lakes-type chondrites; a new grouplet with high $\Delta^{17}\text{O}$ and evidence for nebular oxidation. *Geochim. Cosmochim. Acta*, 55, 2657–2669.
- Weisberg M. K., Prinz M., Clayton R. N., and Mayeda T. K. (1993) The CR (Renazzo-type) carbonaceous chondrite group and its implications. *Geochim. Cosmochim. Acta*, 57, 1567–1586.
- Weisberg M. K., Prinz M., Clayton R. N., Mayeda T. K., Grady M. M., and Pillinger C. T. (1995a) The CR chondrite clan.

- Proc. NIPR Symp. Antarct. Meteorites*, 8, 11–32.
- Weisberg M. K., Boesenberg J. S., Kozhushko G., Prinz M., Clayton R. N., and Mayeda T. K. (1995b) EH3 and EL3 chondrites: A petrologic-oxygen isotopic study (abstract). In *Lunar and Planetary Science XXVI*, pp. 1481–1482. Lunar and Planetary Institute, Houston.
- Weisberg M. K., Prinz M., Clayton R. N., Mayeda T. K., Grady M. M., Franchi I., Pillinger C. T., and Kallemeyn G. W. (1996a) The K (Kakangari) chondrite grouplet. *Geochim. Cosmochim. Acta*, 60, 4253–4263.
- Weisberg M. K., Prinz M., Zolensky M. E., Clayton R. N., Mayeda T. K., and Ebihara M. (1996b) Ningqiang and its relationship to oxidized CV3 chondrites (abstract). *Meteoritics & Planet. Sci.*, 31, 150–151.
- Weisberg M. K., Prinz M., Clayton R. N., and Mayeda T. K. (1997a) CV3 chondrites; three subgroups, not two (abstract). *Meteoritics & Planet. Sci.*, 32, 138–139.
- Weisberg M. K., Prinz M., and Nehru C. E. (1997b) QUE94204: An EH-chondritic melt rock (abstract). In *Lunar and Planetary Science XXVIII*, pp. 1525–1526. Lunar and Planetary Institute, Houston.
- Weisberg M. K., Prinz M., Clayton R. N., Mayeda T. K., Sugiura N., Zashu S., and Ebihara M. (2001) A new metal-rich chondrite grouplet. *Meteoritics & Planet. Sci.*, 36, 401–418.
- Weisberg M. K., Boesenberg J. S. and Ebel D. S. (2002) Gujba and the origin of the CB chondrites (abstract). In *Lunar and Planetary Science XXXIII*, Abstract #1551. Lunar and Planetary Institute, Houston (CD-ROM).
- Weisberg M. K., Connolly H. C. Jr., and Ebel D. S. (2004) Petrology and origin of amoeboid olivine aggregates in CR chondrites. *Meteoritics & Planet. Sci.*, 39, 1741–1753.
- Wheelock M. M., Keil K., Floss C., Taylor G. J., and Crozaz G. (1994) REE geochemistry of oldhamite-dominated clasts from the Norton County aubrite: Igneous origin of oldhamite. *Geochim. Cosmochim. Acta*, 58, 449–458.
- Yanai K. (1994) Angrite Asuka-881371: Preliminary examination of a unique meteorite in the Japanese collection of Antarctic meteorites. *Proc. NIPR Symp. Antarct. Meteorites*, 7, 30–41.
- Yanai K. and Kojima H. (1995) Yamato-8451: A newly identified pyroxene-bearing pallasite. *Proc. NIPR Symp. Antarct. Meteorites*, 8, 1–10.
- Yamaguchi A., Clayton R. N., Mayeda T. K., Ebihara M., Oura Y., Miura Y. N., Haramura H., Misawa K., Kojima H., and Nagao K. (2002) A new source of basaltic meteorites inferred from Northwest Africa 001. *Science*, 296, 334–336.
- Yugami K., Takeda H., Kojima H., and Miyamoto M. (1997) Modal abundances of primitive achondrites and the endmember mineral assemblage of the differentiated trend (abstract). *NIPR Symp. Antarct. Meteorites*, 22, 220–222.
- Zolensky M. E. and Ivanov A. (2003) The Kaidun microbreccia meteorite: A harvest from the inner and outer asteroid belt. *Chem. Erde*, 63, 185–246.
- Zolensky M. E., Score R., Schutt J. W., Clayton R. N., and Mayeda T. K. (1989) Lea County 001, an H5 chondrite and Lea County 002, an ungrouped chondrite. *Meteoritics*, 24, 227–232.
- Zolensky M. E., Weisberg M. K., Buchanan P. C., and Mittlefehldt D. W. (1996) Mineralogy of carbonaceous chondrite clasts in HED achondrites and the moon. *Meteoritics & Planet. Sci.*, 31, 518–537.
- Zolensky M. E., Mittlefehldt D. W., Lipschutz M. E., Wang M-S., Clayton R. N., Mayeda T. K., Grady M. M., Pillinger C. T., and Barber D. (1997) CM chondrites exhibit the complete petrologic range from type 2 to 1. *Geochim. Cosmochim. Acta*, 61, 5099–5115.
- Zolensky M. E., Nakamura K., Gounelle M., Mikouchi T., Kasama T., Tachikawa O., and Tonui (2002) Mineralogy of Tagish Lake: An ungrouped type 2 carbonaceous chondrite. *Meteoritics & Planet. Sci.*, 37, 737–761.