

Research Paper

Temperature and Moisture Conditions for Life in the Extreme Arid Region of the Atacama Desert: Four Years of Observations Including the El Niño of 1997–1998

CHRISTOPHER P. MCKAY,¹ E. IMRE FRIEDMANN,¹ BENITO GÓMEZ-SILVA,²
LUIS CÁCERES-VILLANUEVA,² DALE T. ANDERSEN,³
and RAGNHILD LANDHEIM³

ABSTRACT

The Atacama along the Pacific Coast of Chile and Peru is one of the driest and possibly oldest deserts in the world. It represents an extreme habitat for life on Earth and is an analog for life in dry conditions on Mars. We report on four years (September 1994–October 1998) of climate and moisture data from the extreme arid region of the Atacama. Our data are focused on understanding moisture sources and their role in creating suitable environments for photosynthetic microorganisms in the desert surface. The average air temperature was 16.5°C and 16.6°C in 1995 and 1996, respectively. The maximum air temperature recorded was 37.9°C, and the minimum was –5.7°C. Annual average sunlight was 336 and 335 W m^{–2} in 1995 and 1996, respectively. Winds averaged a few meters per second, with strong föhn winds coming from the west exceeding 12 m s^{–1}. During our 4 years of observation there was only one significant rain event of 2.3 mm, which occurred near midnight local time. We suggest that this event was a rainout of a heavy fog. It is of interest that the strong El Niño of 1997–1998 brought heavy rainfall to the deserts of Peru, but did not bring significant rain to the central Atacama in Chile. Dew occurred at our station frequently following high nighttime relative humidity, but is not a significant source of moisture in the soil or under stones. Groundwater also does not contribute to surface moisture. Only the one rain event of 2.3 mm resulted in liquid water in the soil and beneath stones for a total of only 65–85 h over 4 years. The paucity of liquid water under stones is consistent with the apparent absence of hypolithic (under-stone) cyanobacteria, the only known primary producers in such extreme deserts. **Key Words:** Atacama Desert—Extreme environments—Mars—Hypolithic cyanobacteria. *Astrobiology* 3, 393–406.

¹Space Science Division and ³NASA Ames and SETI Institute, NASA Ames Research Center, Moffett Field, California.

²Departamento de Biomédico and Instituto del Desierto, Universidad de Antofagasta, Antofagasta, Chile.

INTRODUCTION

THE ATACAMA DESERT extends across 1,000 km from 30°S to 20°S along the Pacific coast of South America (Fig. 1). McGinnies *et al.* (1968) list the Atacama Desert in Chile within the Meigs

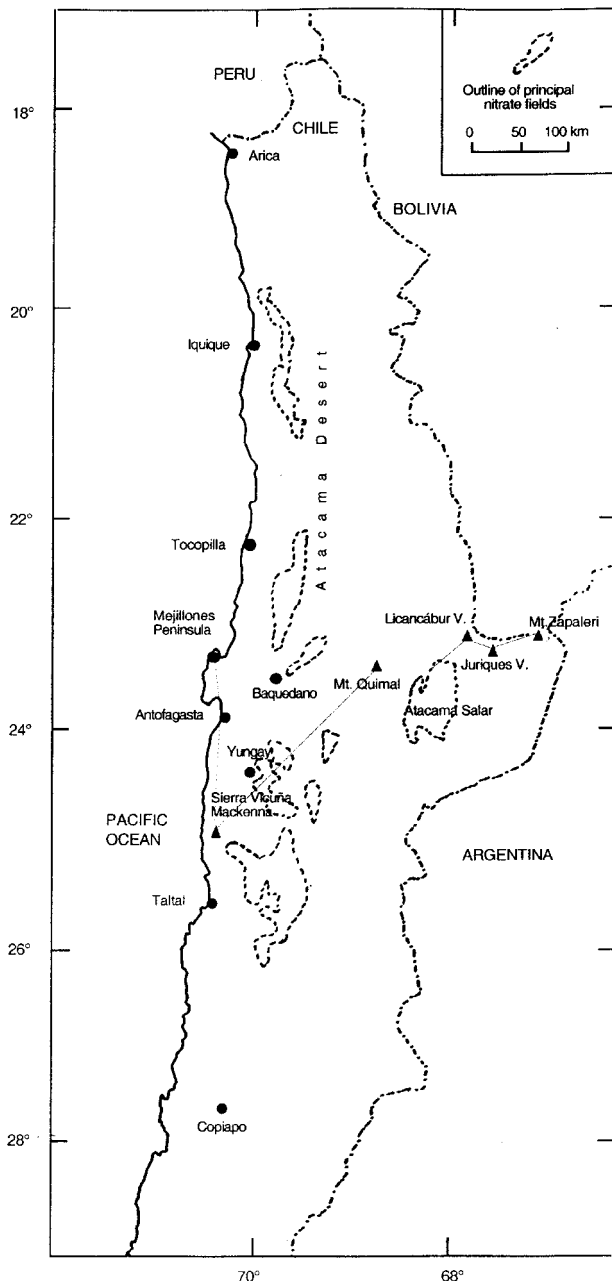

FIG. 1. Location of the study site near Yungay, Chile, an abandoned nitrate mine, in the extremely arid region of the Atacama Desert. In addition to the Yungay and Baquedano, the desert sites mentioned in this paper, the main coastal towns are shown. The locations of the principal nitrate fields are indicated by dotted regions. The mountain peaks used in the topographic profile in Fig. 2 are labeled by triangles. The large saline lake, the Salar de Atacama, is labeled and is near a nitrate field.

classification scheme as Ea23 (E indicates extremely arid, a indicates no marked season of precipitation, 2 indicates mean temperatures during the coldest months between 10°C and 20°C, 3 indicates mean temperatures during the warmest months between 20°C and 30°C). As discussed before (e.g., Börgel, 1973; Caviedes, 1973; Miller, 1976; Rundel *et al.*, 1991) the desert owes its extreme aridity to the climatic regime dominated by a constant temperature inversion due to the cool north-flowing Humboldt ocean current and the presence of the strong Pacific anticyclone. The position of the Pacific anticyclone is generally stable with a small shift of a few degrees south in the summer (Trewartha, 1961). The main elements of climate dynamics in the arid region along the Pacific coast and particularly in the Atacama Desert are described in Lettau (1976), Rutllant and Ulriksen (1979), Abreu and Bannon (1993), and Rutllant *et al.* (1998, 2000).

Geological and soil mineralogical evidence suggests that extreme arid conditions have persisted in the southern Atacama for 10–15 Myrs (Ericksen, 1983; Berger and Cooke, 1997), making it probably the oldest desert on Earth. The Atacama is a temperate desert, and although it is not extremely hot, it is one of the driest deserts in the world. The driest parts of the Atacama Desert are located between ~22°S to 26°S (Börgel, 1973) in the broad valley formed by the coastal range and the medial range as shown in Fig. 2. The age and aridity of the Atacama are probably directly responsible for the large nitrate accumulations that are present there. The nitrates are likely to be of atmospheric origin (Böhlke *et al.*, 1997) and are not biologically decomposed or carried away by water flow because of the extreme aridity and have accumulated into significant concentrations over the long age of the desert. In the early 1900s nitrate mining operations were conducted in this area, but most are now abandoned.

The climate throughout South America is affected by changes in rainfall due to El Niño. El Niño events can bring heavy rainfall to the deserts of Peru, and stronger events can penetrate further inland and southward. The rainfall regime within the region and its relation to El Niño have been analyzed by Ortlieb (1995) and Vargas *et al.* (2000). Vargas *et al.* (2000) have shown that mudflows in the coast at Antofagasta during the 20th Century are related to the occurrence of El Niño events. Ortlieb (1995) also found that heavy rains in Antofagasta reported in his-

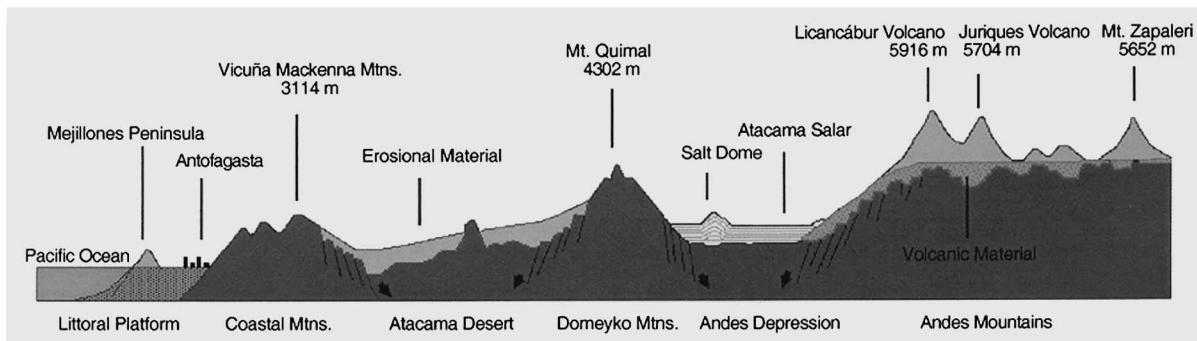

FIG. 2. Cross-section of the desert region in the vicinity of Antofagasta, Chile (drawing adapted from Turis Tel'94 guidebook). The peaks listed are indicated by triangles on Fig. 1.

toric times were correlated with El Niño events (e.g., 1982, 1987). Ulloa *et al.* (2001) monitored the temperature, dissolved oxygen, chlorophyll-*a*, and zooplankton in the coastal waters off Antofagasta during the 1997–1998 El Niño event and found that perturbations associated with El Niño were clearly present.

Proxy temperature records indicate that increased precipitation from El Niño events occurred from 10,000 to 16,000 years ago, though rains still did not penetrate the absolute desert region (Betancourt *et al.*, 2000). A 106,000-year paleoclimate record from a drill core from the Salar de Atacama (see Fig. 1 for location) also indicates episodic wet periods during the past (Bobst *et al.*, 2001). Bobst *et al.* (2001) found that the early Holocene wet interval at Salar de Atacama was synchronous with the maximum Holocene lake levels of the Chilean Altiplano lakes to the east and with grass-rich rodent middens between 11,800 and 10,500 years in age from the Atacama basin (cf. Betancourt *et al.*, 2000).

Thus, the effects of a strong El Niño event on the coast of South America do reach as far south as Antofagasta, and so the determination of any effects in the Atacama Desert at this latitude is of interest. We were fortunate to have our data include the period of the strongest recent El Niño, which spanned from April 1997 to mid-May 1998 (McPhaden, 1999; Takayabu *et al.*, 1999), and we can therefore determine directly the effect of this El Niño on rain in the central Atacama.

In extreme arid deserts, with higher plants rare or practically absent, the main or only source of photosynthesis is by microorganisms (Friedmann *et al.*, 1967; Friedmann and Galun, 1974), mostly cyanobacteria. These live under translucent stones of pavements (hypoliths) or below the surface of translucent porous rock [cryptoendoliths

or chasmoendoliths (Friedmann and Ocampo-Friedmann, 1977; Golubic *et al.*, 1981)]. Light levels in these habitats are sufficient to allow for photosynthesis, and the microenvironment under stones (Jury and Bellantouni, 1976a,b) or inside rocks apparently traps moisture necessary for life.

In deserts, the controlling environmental factor for life is the availability of water. Hypolithic algae appear to be absent in the dry core region of the Atacama. The purpose of this study was to collect meteorological and soil moisture data to understand the effect of the physical environment, especially liquid water, on the distribution of photosynthetic microorganisms so as to quantitatively determine the limits of life as set by the availability of water. Understanding the limits of life on Earth in desert environments can help establish models for survival in the dry conditions on Mars.

SITE DESCRIPTION AND METHODS

Our study site is located in the Atacama Desert within the University of Antofagasta Desert Research Station (24°04'50" S, 69°5'11" W, elevation 900–1,000 m) near the abandoned nitrate mine of Yungay. Geomorphologically, our study site, like most of the central Atacama Desert, is covered by a rather sparse desert pavement with small stones or pebbles lying on or partly embedded in the soil. Such stones form a suitable habitat for hypolithic cyanobacteria and algae (Vogel, 1955; Friedmann *et al.*, 1967; Friedmann and Galun, 1974). The surface is characterized by a dried soil surface with little moving sand and few stones. Drill cores show that the vertical soil profile is composed of broad alternate layers of sandy soil and impervious clay, which inhibits vertical wa-

ter diffusion. There is virtually no vegetation except at rare sites where the water table reaches the surface. Throughout the region the water table is typically at ≥ 25 m depth. Figure 1 shows the location of the study site, and Fig. 2 shows a representative cross section of the topography of the region. There are no permanent human settlements in the central desert near Yungay.

The meteorological station was based on a Campbell 10 \times data logger operated by solar-recharged batteries. The system records air temperature and relative humidity (RH) at 2 m above the surface using a Campbell 207 probe in a ventilated radiation shield. The error in the temperature measurement is $\pm 0.2^\circ\text{C}$. The error in the humidity measurement is $<10\%$. However, an important caveat is that the Campbell 207 RH sensor has high errors for RH values below 15%—usually tending to systematically overestimate values. A 05013 RM Young Wind Monitor (wind speed and direction) was mounted at approximately a 2.5 m height. A Texas Electronics TE525 tipping bucket rain gauge was placed 20 cm above the ground about a meter from the station. Our onsite calibration after 3 years in the field showed good operation and an accuracy of better than 6%. Nearby, mounted to the top surface of a small stone, a Campbell 237 leaf wetness instrument was used as a dew indicator. The dew sensor recorded a signal from 0 to 1 that is dependent on the amount of moisture present on the sensor surface. There is no quantitative calibration for this unit, but its proper operation was confirmed after 3 years in the field. A LiCor Li200 pyranometer recorded solar flux. The Li200 is based on a silicon detector sensitive to light of wavelengths from 0.4 to 1.1 μm . It was calibrated against an Eppley precision pyranometer, and the error in the averaged light measurement was $<10\%$.

At ground level, one RH chip (PCRC-11, Phys-Chem Scientific Corp.) was placed beneath a small (6 cm in diameter) quartzite stone of the desert pavement; another was placed in the soil surface a few centimeters away. The sensors extend to ~ 2 cm below the surface. Another unit was placed at 10 cm depth in the soil. The PCRC-11 is the same sensor element used in the Campbell 207 probe. In the extreme dry soils of the Atacama Desert, RH sensors are a practical way to monitor soil moisture. The temperature of the underside of the quartzite stone was measured using a copper-constantan thermocouple. Conduc-

tivity probes to measure soil moisture were also placed under the stone, as well as under another quartzite stone similar in size located a few centimeters away. The soil conductivity probe is based on the voltage drop across two bare wires, 5 mm apart, referenced to a 2.2 k Ω (kohm) resistor utilizing a 2.5-V alternating current excitation.

All sensors were sampled once every 3 min, and the average of 10 measurements was written to final memory every 30 min, corresponding to 48 recordings each day. For wind direction the instantaneous direction at the time of output was recorded, not the average.

The station was emplaced on September 24, 1994, and operated until it was removed on October 16, 1998. No useful data on wind direction were obtained before November 31, 1995. Because of loss of the solar power panel the station did not operate from September 2, 1997, to October 15, 1997. In total, 1,438 complete days of data were recorded and 46 complete months. The complete dataset, as well as monthly averages, are available from the authors electronically.

RESULTS

Monthly summaries of the key meteorological data are listed in Table 1. The list includes the maximum, average, and minimum values for the air temperature and air humidity. Also listed is total rain; hours of dew; number of nights with dew; hours that the conductivity beneath the two stones exceeded 10 μS (a siemen is the SI unit of conductance and is equal to 1 inverse ohm); maximum, average, and minimum values for the stone temperature; maximum, average, and minimum values for the RH under the stone and in the soil; average light; and wind speed.

Temperature

The temperature regime in the Atacama Desert is not extremely hot, nor are extremes of cold reached (e.g., compared with Death Valley where air temperatures exceed 50°C for many days in the summer). The maximum air temperature recorded over the 4-year period was 37.9°C , and the minimum was -5.7°C . Figure 3 shows daily maximum, average, and minimum temperature for each day in 1996. Typically, daytime maximum temperatures reach 32°C . There is more seasonal variation in the minimum with summer

TABLE 1. METEOROLOGICAL AVERAGES FROM YUNGAY

Year/month	Th	Tm	Tl	RHh	RHm	RHI	Rain	Hrd	Nd	Ω1	Ω2	Trh	Trm	Trl	RHrh	RHrm	RHrl	RHsh	RHsm	RHsl	hv	V	
94/10	36	16.7	1.8	100	28	8	0	62.5	9	0	0	51.8	21.7	3.1	49	18	11	100	40	11	404	2.9	
94/11	36.2	18.2	2.1	100	39	8	0	159	21	0	0	56.4	24.1	4.4	31	15	10	44	16	10	437	3.2	
94/12	36.1	20	5.9	100	41	8	0	90	17	0	0	56.3	26.1	7.7	32	15	10	43	17	10	430	3.4	
95/1	34.6	20.2	5.6	100	45	9	0	133	23	0	0	54.3	26.3	7.6	34	17	10	44	20	10	422	3.4	
95/2	35	20	6	94	43	9	0	142	20	0	0	54.8	25.4	7.3	33	17	10	42	19	10	402	3.1	
95/3	35.5	19.2	4.3	98	43	9	0	166	20	0	0	52.3	23.6	6.4	33	18	11	42	21	11	348	2.9	
95/4	34.5	17.1	1	100	35	9	0	136	14	0	0	45.5	20.3	3.8	32	17	12	43	19	12	304	2.3	
95/5	32.6	14.7	0.9	100	39	9	0	101	11	0	0	40.7	17	0.5	38	19	13	51	22	13	248	2	
95/6	33.8	13.4	-1.2	100	33	9	0.1	25.5	4	0	0	37.9	15	-1.8	34	19	14	47	21	14	232	1.6	
95/7	33	11.7	-3.5	100	28	9	0.3	36.5	4	0	0	36.5	13.3	-3.3	32	17	14	42	18	14	244	1.7	
95/8	35	12.7	-3.8	100	28	9	0	25.5	4	0	0	41	15.2	-3.8	30	17	13	41	17	13	277	1.8	
95/9	34.9	16	-0.1	99	29	9	0	31.5	7	0	0	46.8	19.9	2	33	16	12	45	17	12	327	2.4	
95/10	34	16.9	0.4	98	20	9	0	2.5	1	0	0	53	22	2.5	21	14	11	30	14	11	385	2.6	
95/11	34.7	18.4	2.8	99	24	9	0	3	3	0.5	0	53.7	24.6	5.2	91	13	10	94	13	10	418	2.9	
95/12	36.3	19.2	3.9	98	33	8	0	6	3	0	0	57.4	25.9	7.1	27	14	10	38	15	10	430	3.1	
96/1	33.8	19.7	5.5	97	35	9	0	8.5	4	0	0	54	26.3	8	30	15	10	45	16	10	423	3.2	
96/2	35.6	19.9	5.9	94	36	8	0	1.5	2	0	0	55	25.6	8.4	30	15	10	42	17	10	389	3	
96/3	34	19.2	3.2	97	37	9	0	4.5	2	0.5	0	50.4	23.9	5.5	31	16	11	48	19	10	347	2.8	
96/4	35.7	16.6	2.7	97	31	8	0	4	2	0	0	45.8	20.1	4.6	30	16	11	44	18	11	294	2.2	
96/5	35.1	14.5	-2.6	96	25	8	0	1	1	0	0	42	16.7	-2.3	26	16	13	33	17	13	248	1.8	
96/6	34	12.2	-4.1	94	23	9	0	0	0	1	0	35.5	13.6	-4.7	32	17	14	45	18	14	224	1.6	
96/7	34	13.3	-4.9	97	22	9	0	12.5	2	0	0	38.5	14.9	-4.9	29	16	14	43	17	14	243	1.7	
96/8	33.9	14.1	-2.1	97	26	9	0.1	1.5	1	8	0	41.1	16.9	-1.3	55	16	13	64	17	13	285	2	
96/9	35.4	14.9	-3	97	28	8	0	4.5	4	4.5	0	47.9	19	-2.2	27	15	12	45	16	12	336	2.5	
96/10	35.3	16.5	-0.3	96	26	8	0	2.5	2	0	0	54.8	22	2	25	14	11	36	14	11	390	2.8	
96/11	36.6	18.5	3.3	95	31	8	0	15	4	0	0	57.4	24.9	6.4	23	13	10	34	14	10	414	3.2	
96/12	35.4	19.4	4	87	26	8	0	0	0	0	0	53.9	25.7	6.7	23	13	10	31	13	10	430	3.2	
97/1	34.3	20.1	6.5	92	35	9	0	7.5	1	0	0	52	26.4	9	30	15	10	41	17	10	412	3.4	
97/2	35.7	20.8	5.9	91	29	8	0	0	0	0	0	53.6	26.2	8.1	32	15	10	44	17	10	378	3	
97/3	37.2	20	6.3	91	36	8	0	3.5	3	0	0	53.4	24.5	8.2	35	18	10	48	21	10	343	2.8	
97/4	33.4	17.5	2.9	94	32	9	0	14	2	0	0	44.2	20.5	6.1	29	17	11	38	19	11	294	2.3	
97/5	33.8	15.7	0.7	94	37	9	2.3	45	9	64.5	85.5	41.1	17.8	2.4	100	42	13	100	41	13	235	2	
97/6	31	13.6	-0.3	92	36	10	0	9.5	2	0	0	37.2	15.5	0.5	52	30	18	59	31	16	215	1.7	
97/7	36.4	13.4	-1.6	92	32	8	0	8.5	3	0	0	40.6	15.2	-1.2	49	25	13	58	25	13	232	1.8	
97/8	37	16.3	0.7	91	25	8	0	1	1	0	0	44.6	18.8	2	43	21	12	51	21	12	263	2	
97/9																							
97/10																							
97/11	37	18.8	2.9	86	27	8	0	15.5	5	0	0	56.6	25.6	6.8	33	14	10	40	15	10	413	2.8	
97/12	37.9	21	6.1	83	32	7	0	11	6	0	0	56.8	27.9	8.2	32	15	9	43	16	9	423	3	
98/1	37	22.3	8.5	82	38	8	0.1	10.5	6	0	0	57.2	28.9	11.5	38	20	9	48	23	9	408	3.2	
98/2	37.3	22.1	8	77	30	8	0	6.5	2	0	0	57.4	28	10.5	35	19	10	41	21	9	379	2.9	
98/3	36.1	20.3	5.7	74	30	8	0	1.5	1	0	0	52.7	24.9	7.8	38	20	10	48	23	10	340	2.7	
98/4	34.8	17.5	3	78	31	9	0	23.5	4	0	0	46.5	20.5	5.7	37	23	14	47	26	13	279	2.3	

TABLE 1. METEOROLOGICAL AVERAGES FROM YUNGAY (CONT'D)

Year/month	Th	Tm	Tl	RHh	RHm	RHI	Rain	Hrd	Nd	$\Omega 1$	$\Omega 2$	T _{rh}	T _{rm}	T _{rl}	RH _{rh}	RH _{rm}	RH _{rl}	RH _{sh}	RH _{sm}	RH _{sl}	h ν	V
98/5	35.7	15.1	-1.2	75	26	8	0	6.5	2	0	0	38.7	16.8	0.9	36	20	13	44	22	13	240	1.8
98/6	32.3	13.7	-1.9	70	22	9	0	6	2	0	0	34.4	14.9	0.3	35	19	14	45	20	14	223	1.7
98/7	32.8	13.5	-2.4	70	19	9	0	3	2	3.5	0	37.1	15.3	-0.7	34	18	14	48	19	14	233	1.6
98/8	33.2	12.7	-5.7	69	19	9	0	6	3	0	0	41	15.2	-4.4	26	17	13	35	17	13	280	1.8
98/9	34.5	14.1	-2.5	70	19	9	0	2	1	0	0	48.4	18.3	-0.5	27	15	12	34	16	12	331	2.2

Th, Tm, and Tl, maximum, average, and minimum values, respectively, for air temperature; RHh, RHm, and RHI, maximum, average, and minimum values, respectively, for air humidity; total rain (in mm); hours of dew (Hrd); number of nights with dew (Nd); $\Omega 1$ and $\Omega 2$, hours that the conductivity beneath the two stones exceeded 10 μS (a siemen is the SI unit of conductance and is equal to 1 inverse ohm); T_{rh}, T_{rm}, and T_{rl}, maximum, average, and minimum values, respectively, for the stone temperature; RH_{rh}, RH_{rm}, and RH_{rl}, maximum, average, and minimum values, respectively, for the RH under the stone; RH_{sh}, RH_{sm}, and RH_{sl}, maximum, average, and minimum values, respectively, for the RH in the soil; h ν , average light (in W m⁻²); V, wind speed (in m s⁻¹).

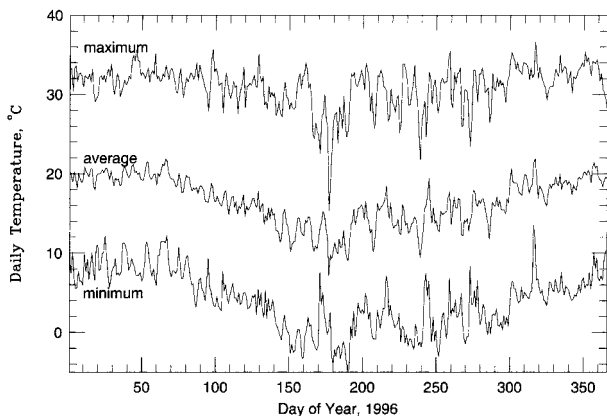

FIG. 3. Daily maximum, minimum, and average temperatures in the Atacama Desert for the year 1996.

minima at $\sim 10^{\circ}\text{C}$, and winter levels near 0°C . Over the 4-year period of this data set there was only small interannual temperature variability. Figure 4 compares the monthly mean temperatures for the entire data set. As seen in Fig. 4, the year-to-year variations in mean monthly temperatures are typically less than a few degrees. For 1995 and 1996, the data collected were uninter-

rupted, and yearly averages can be computed. The average air temperature was 16.5°C in 1995 and 16.6°C in 1996. The stones on the desert floor heat up $\sim 20^{\circ}\text{C}$ above the air temperature under full sunlight.

Moisture

In contrast to temperature and light, moisture in the Atacama Desert is highly variable on daily, monthly, and yearly time scales. The complete record of those sensors that record moisture is shown in Fig. 5. Dew occurred throughout the measurement period but showed interannual variability. Early 1995 had almost continuous dew at night, while significant periods near June 1996 had no dew. We are confident that the variation in dew seen in Fig. 5 is real because of the simplicity of the dew sensor (exposed wires) and repeated field testing of the sensor throughout the measurement interval. Thus 1994–1995 may have been an unusual period of heavy dew, while the record for 1996 onward may be more typical. In the absence of rain, the soil humidity was $<30\%$, which is extremely dry for soil corresponding to a water potential of -166 MPa .

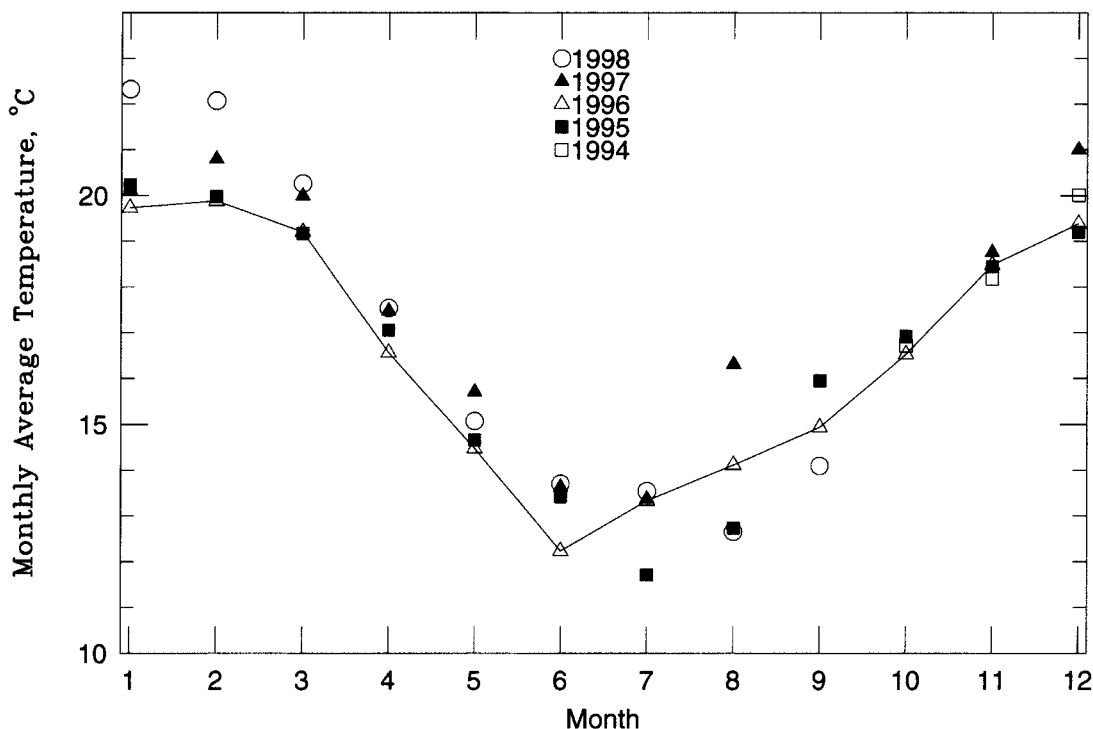

FIG. 4. Monthly average temperatures in the Atacama Desert from September 1994 to September 1998. Open squares are for 1994, solid squares are for 1995, open triangles are for 1996, solid triangles are for 1997, and open circles are for 1998. The solid line connects the points for 1996, which are shown in detail in Fig. 3.

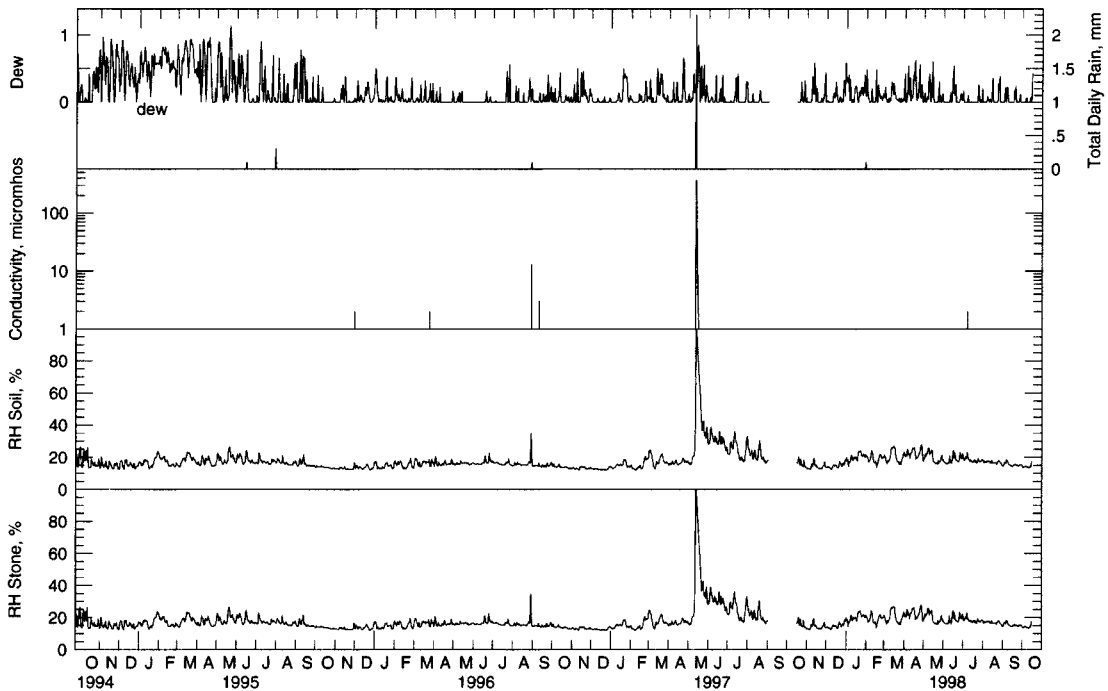

FIG. 5. Moisture patterns in the Atacama Desert. **Top panel:** Both dew (0 to 1 from the dew sensor is plotted as ranging from 1 to 2 mm on the rain scale) and rain. **Second panel:** Conductivity beneath the stone. **Third panel:** RH in the surface soil (0–2 cm). **Bottom panel:** RH beneath the stone. Dew is common, but the only significant rain event was 2.3 mm on 11 May 1997. Only during this rain event was moisture present in the soil or beneath the stone at levels >80% humidity.

Only five rain events were recorded. These are listed in Table 2. Three of the rain events were just at the limit of detection (0.1 mm), and a fourth was at 0.3 mm. These small rain events probably represent heavy dew that collected in the rain gauge. On May 11, 1997, the only significant rain (2.3 mm) occurred in a single 30-min recording period close to midnight, which represents >20 tips of the recording bucket. As seen in Table 2, most of the rain events occurred at night or early in the morning. We suggest that these rain events were merely the precipitation of heavy fog, possibly due to unusually large fog droplets created as a result of a smaller than normal number of condensation nuclei present on those days.

TABLE 2. RAIN EVENTS IN THE ATACAMA DESERT AT YUNGAY STATION (SEPTEMBER 1994–SEPTEMBER 1998)

Local standard time	Date	Rain (mm)
08:30	June 15, 1995	0.1
01:30	July 30, 1995	0.3
01:30	August 31, 1996	0.1
22:30	May 11, 1997	2.3
09:30	January 30, 1998	0.1

A detailed look at the days after the largest rain event (2.3 mm) is shown in Fig. 6. The RH and conductivity beneath the stone and the soil humidity all confirm the presence of a significant rain event. The rain produced increased soil moisture lasting several days, with moist conditions under the stones only marginally longer. Actual liquid water (RH >95% and $\Omega >10 \mu\text{S}$) occurred under the stones for ~65–85 h (see Table 1). Within 10 days both subsurface RH levels were close to their pre-rain value. Though fluctuations in the data indicated increased surface moisture for 30 days rather than just 10 days, this variation may not be significant given the limitation of sensor accuracy at low moisture level. The rain event occurred during the start of the 1997–1998 El Niño while the sea surface temperatures were rising but not yet reaching the high values associated with the main El Niño phase that occurred in June or July 1997, or possibly even November 1997 (see Fig. 5 of McPhaden, 1999). However, the data of Ulloa *et al.* (2001) show El Niño effects off the coast at Antofagasta as early as April 1997, so this rain event may have been an El Niño effect.

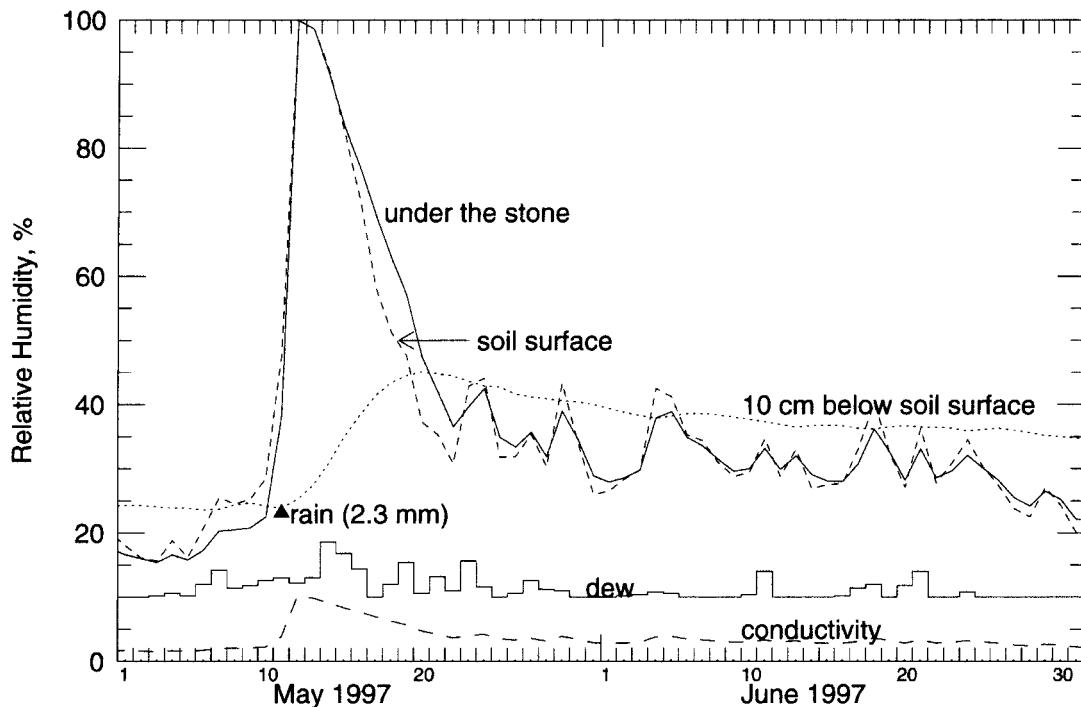

FIG. 6. Detailed plot of the rain event of May 11, 1997 showing the 2.3 mm rain (indicated by the solid triangle), daily average values of the RH of the soil surface, 10 cm below the soil surface, and under a surface stone, dew (0 to 1 from the dew sensors is plotted as ranging from 10% to 20% RH), and conductivity (in units of μS using the RH axis). High moisture levels as indicated by RH values $>80\%$ persist in the soil surface for many days after rain and for slightly longer under the stone. The moisture increase at 10 cm below the soil lags the rain event by 10 days.

As seen in Fig. 6, the RH indicator at 10 cm below the soil surface recorded increased soil water content ~ 10 days after the rain event. The increase is significant (45% RH) compared with the pre-rain baseline ($\sim 25\%$ RH) and declines over time scales of more than a month. This is the only indication in our data of moisture change with depth and suggests that moisture flow from the surface downward does occur after significant rain. Moisture flow from subsurface water tables to the surface, however, was not evident.

As seen in Fig. 5, high nighttime RH and dew occur frequently in the central Atacama. However, dew by itself did not produce measurable moisture in the soil or under the stone (though dew would have produced wetness on plant surfaces no plants were present). Only rain resulted in soil moisture. Figure 7 shows a typical dew night. At midnight the air RH was high, essentially saturated. Dew formed as indicated by the dew sensor was present all through the pre-dawn hours. At dawn, temperatures rose, and the dew dissipated. The wind speed was low in the pre-dawn hours and morning, rising in the early af-

ternoon with the strong winds blowing from the west. It is interesting to compare Fig. 7 with Fig. 8, a night just 2 weeks earlier in which no dew was recorded. Temperature, light levels, and wind profiles are indistinguishable between the two days, and yet there is no dew or high nighttime humidity. We suggest that this indicates that nighttime air moisture is a function of the source of the air mass: Moist air moving in from the Pacific can create dew, while dry air moving from inland would not. The regular formation of thick stratus cloud banks below 1,000 m along the coast dissipates inward when the topography is low and flat. Dense fogs, termed *camanchaca* in Chile, are observed around steep slopes or isolated mountains near the coast (e.g., Berger and Cooke, 1997, p. 584) and are an important ecological source of moisture along the coastal range (Rundel *et al.*, 1991). Our results indicate that the *camanchaca* reach the interior desert at night, resulting in high humidity and dew, but they are not an important source of moisture.

There are no permanent recording stations near our site, but we can compare our record of rain

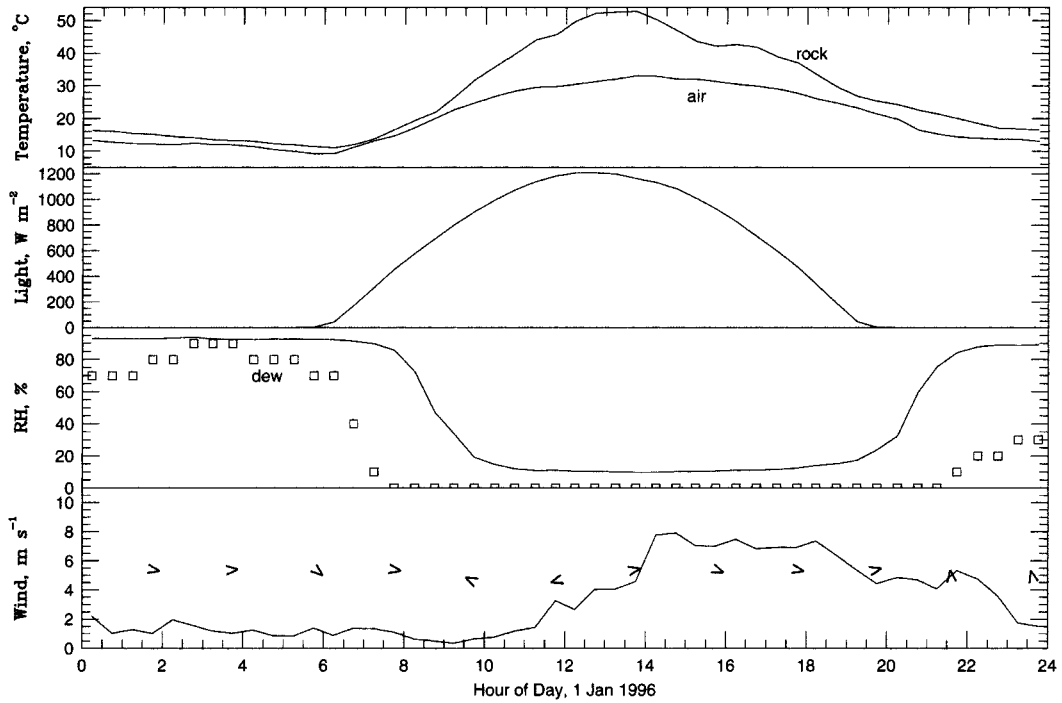

FIG. 7. Daily cycle of stone and air temperature, sunlight, air RH (solid line), dew (open squares showing 0 to 1 from the dew sensor ranging from 0% to 100% RH), wind speed (solid line), and wind direction (shown as arrows added to the wind speed plot; north is up, east is 90° to the right). Dew and high humidity occur in the night. Time is local standard time, 4 h west of Greenwich Mean Time.

with the rain reported for the city of Baquedano (23°13'S, 69°50'W, elevation 1,032 m), which is listed in Table 3. The same pattern of high inter-annual variability is seen in the Baquedano record.

The fact that dew did not result in measurable moisture under stones is significant. Friedmann *et al.* (1967), based on dew measurements only, tentatively suggested that the main source of wa-

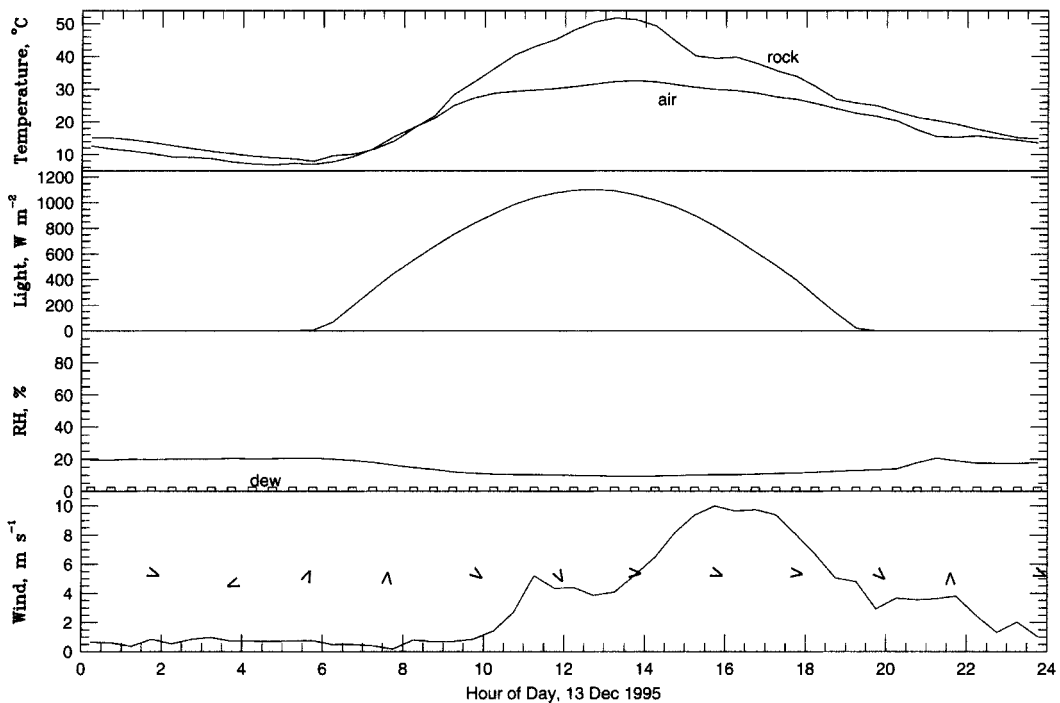

FIG. 8. Same as Fig. 7 but 2 weeks earlier, showing a day without high humidity and dew.

TABLE 3. MEASURED PRECIPITATION (IN MM) FROM BAQUEDANO, CHILE

Year	January	February	March	April	May	June	July	August	September	October	November	December	Total
1975	—	—	—	0	0	0	0	0	—	—	0	0	0
1976	0	—	—	—	—	—	—	0	1	0	0	0	1
1977	0	0	0	0	0	0	0	0	0	0	0	0	0
1978	0	0	0	0	0	0	0	0	0	0	0	0	0
1979	0	0	1	0	0	0	0	0	0	0	0	0	1
1980	0	0	0	0	0	0	0	0	0	0	0	0	0
1981	0	0	0	0	0	0	0	0	0	0	0	0	0
1982	0	0	0	0	0	0	0	0	0	0	0	0	0
1983	0	0	0	0	0	1	0.5	0	0	0	0	0	1.5
1984	0	0	1.5	0	0	9.5	0	0	0	0	0	0	11
1985	0	0	0	0	0	0	0	0	0	0	0	—	0
1986	0	0	0	0	0	0.1	0	0.5	0	0	0	0	0.6
1987	0	0	0	0	0	0	3.6	0	0	0	0	0	3.6
1988	0	0	0	0	0	0	0	0	0	0	0	0	0
1989	0	0	0	0	0	0	0	0	0	0	0	—	0
1990	0	0	0	0	0	0	0	0	0	0	0	0	0
1991	0	0	0	0	0	17.5	0	0	—	—	—	—	17.5
1992	0	0	0	0	0	0	0	0	0	0	0	0	0
1993	0	0	0	0	0	0	0	0	—	—	—	—	0
1994	—	—	—	—	—	—	—	—	0	0	0	0	0

ter for hypolithic cyanobacteria in the Negev Desert (Meigs classification Ac24) is dew. In light of our measurements, this does not seem to be the case in the arid region of the Atacama.

Light

The central Atacama is exceptionally free of clouds. Uninterrupted light levels as shown in Figs. 7 and 8 are typical. The annual average sunlight was 336 W m⁻² in 1995 and 335 W m⁻² in 1996. This can be compared with the annual average sunlight above the atmosphere for this location, which we compute to be 387 W m⁻²—an atmospheric transmissivity of 87%. Figures 7 and 8 also show that solar heating raised the temperature of the desert floor above the air temperature by 20°C. The maximum stone temperature occurs at the time of maximum light, while the maximum air temperature lags behind maximum light by a few hours.

Wind

In many deserts, the temperature and moisture content of the air depend strongly on wind direction. This is expected in the Atacama, which is bordered on the west by the Pacific Ocean and on the east by the Andes. Figures 9 and 10 show the correlations between wind speed and direction, and air temperature and air humidity. In general, the data indicate that high

wind speeds are associated with warm, dry air, and that the wind direction for these dry hot winds is from the west toward the east (wind direction 270°). This would be consistent with downslope (föhn) winds coming from the coastal mountains. As these winds descend they are adiabatically heated and desiccated. Strong downslope winds from the Andes are not indicated in our data. This would suggest that particulate transport by high winds would tend to move material from west to east.

CONCLUSIONS

Based on the 4 years of data presented here we reach the following conclusions:

1. The strong El Niño of 1997–1998 did not bring significant rain or increased moisture to the extreme arid region of the central Atacama.
2. Dew occurs frequently following high nighttime RH. However, dew is not a source of moisture in the soil or under stone surfaces. Groundwater also does not contribute to surface moisture. Only the single rain event of 2.3 mm resulted in detectable liquid water under the stone and in the surface soil.
3. Anecdotal reports of low rain frequency (typically once per decade) are supported by our dataset.

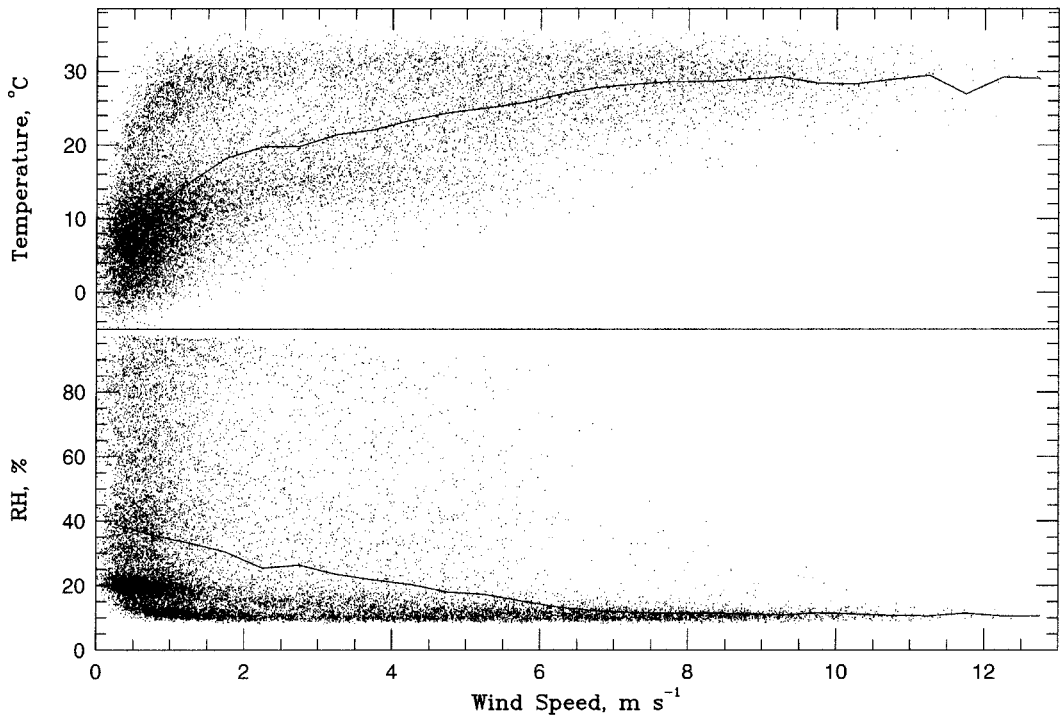

FIG. 9. Correlation between air temperature (top) and air RH (bottom) with wind speed for the year 1996. Each point represents a single 30-min sampling interval. The solid curve shows the average value of each parameter versus wind speed.

4. Strong winds in the Atacama are associated with warm, dry föhn winds coming down from the coastal mountains. These winds may be an important transport mechanism for salts

- and minerals, and would tend to accumulate material on the east side of the central depression.
- 5. During our study period of 4 years, liquid water was present under stones for only 65–85 h. This low level is consistent with the absence of hypolithic cyanobacteria under translucent stones in the extreme arid regions of the Atacama.
- 6. The extent of liquid water present in this dry environment on Earth provides a standard against which to compare the transient melting of water on the surface of Mars (e.g., Hecht, 2002; Kuznetz and Gan, 2002).

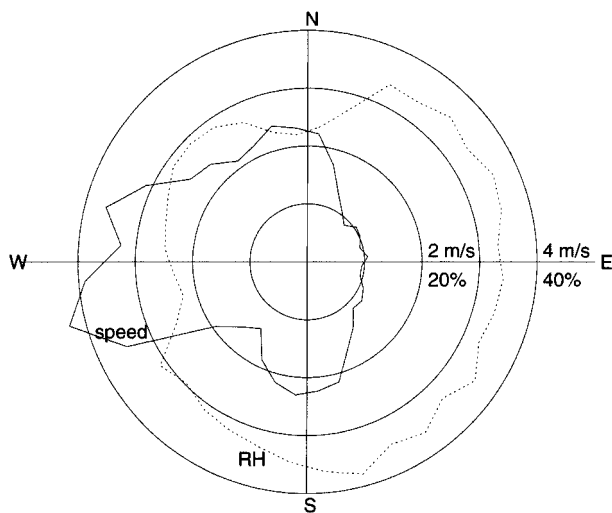

FIG. 10. Correlation between average wind speed (solid line, scale 0–4 m/s) and average air RH (dotted line, scale 0–40%) with wind direction. The strong winds blow from the west and are dry consistent with the correlation in Fig. 9.

Like many deserts of the world, the Atacama shows considerable yearly variability in moisture. To understand its climate will require a record of meteorological data that is longer than presented here. An adequate data set may need to span 30 years.

ACKNOWLEDGMENTS

We thank Brad Sutter, Kim Warren-Rhodes, two anonymous reviewers, and the journal edi-

tor for helpful reviews and comments and Steve Warren for the suggestion that the rain event was a precipitation of a heavy fog. This work was supported by subventions from the NASA Exobiology program.

ABBREVIATION

RH, relative humidity.

REFERENCES

- Abreu, M.L. and Bannon, P. (1993) Dynamics of the South American coastal desert. *J. Atmos. Sci.* 50, 2952–2964.
- Berger, I.A. and Cooke, R.U. (1997) The origin and distribution of salts on alluvial fans in the Atacama Desert, Northern Chile. *Earth Surface Processes Landforms* 22, 581–600.
- Betancourt, J.L., Latorre, C., Rech, J.A., Quade, J., and Rylander, K.A. (2000) A 22,000-year record of monsoonal precipitation from northern Chile's Atacama Desert. *Science* 289, 1542–1546.
- Bobst, A.L., Lowenstein, T.K., Jordan, T.E., Godfrey, L.V., Ku, T.-L., and Luo, S. (2001) A 106ka paleoclimate record from drill core of the Salar de Atacama, northern Chile. *Paleogeogr. Paleoclimatol. Paleoecol.* 173, 21–42.
- Böhlke, J.K., Ericksen, G.E., and Revesz, K. (1997) Stable isotopic evidence for an atmospheric origin of desert nitrate deposits in northern Chile and southern California, USA. *Chem. Geol.* 136, 135–152.
- Börgel, R.O. (1973) The coastal desert of Chile. In *Coastal Deserts, Their Natural and Human Environments*, edited by D.H. Amiran and A.W. Wilson, University of Arizona Press, Tucson, pp. 111–114.
- Caviedes, C.L. (1973) A climatic profile of the north Chilean desert at latitude 20 south. In *Coastal Deserts, Their Natural and Human Environments*, edited by D.H. Amiran and A.W. Wilson, University of Arizona Press, Tucson, pp. 115–121.
- Ericksen, G.E. (1983) The Chilean nitrate deposits. *Am. Sci.* 71, 366–374.
- Friedmann, E.I. and Galun, M. (1974) Desert algae, lichens, and fungi. In *Desert Biology*, edited by G.W. Brown, Academic Press, San Diego, pp. 165–212.
- Friedmann, E.I. and Ocampo-Friedmann, R. (1977) Endolithic microorganisms in extreme dry environments: analysis of a lithobiotic habitat. In *Current Perspectives in Microbial Ecology*, edited by M.J. Klug and C.A. Reddy, American Society for Microbiology, Washington, DC, pp. 177–185.
- Friedmann, E.I., Lipkin, Y., and Ocampo-Paus, R. (1967) Desert algae of the Negev (Israel). *Phycologia* 6, 185–200.
- Golubic, S., Friedmann, I., and Schneider, J. (1981) The lithobiotic ecological niche, with special reference to microorganisms. *J. Sediment. Petrol.* 51, 475–478.
- Hecht, M.H. (2002) Metastability of liquid water on Mars. *Icarus* 156, 373–386.
- Jury, W.A. and Bellantuoni, B. (1976a) Heat and water movement under surface rocks in a field soil: I. Thermal effects. *Soil Sci. Soc. Am. J.* 40, 505–509.
- Jury, W.A. and Bellantuoni, B. (1976b) Heat and water movement under surface rocks in a field soil: II. Moisture effects. *Soil Sci. Soc. Am. J.* 40, 509–513.
- Kuznetz, L.H. and Gan, D.C. (2002) On the existence and stability of liquid water on the surface of Mars today. *Astrobiology* 2, 183–195.
- Lettau, H. (1976) Dynamics and energetic factors which cause and limit aridity along South America's Pacific coast. In *World Survey of Climatology, Vol. 12: Climate of Central and South America*, edited by W. Schwerdfeger, Elsevier, Amsterdam, pp. 188–192.
- McGinnies, W.G., Goldman, B.J., and Paylore, P. (1968) *Deserts of the World*, University of Arizona Press, Tucson.
- McPhaden, M.J. (1999) Genesis and evolution of the 1997–98 El Niño. *Science* 283, 950–954.
- Miller, A. (1976) The climate of Chile. In *World Survey of Climatology, Vol. 12: Climate of Central and South America*, edited by W. Schwerdfeger, Elsevier, Amsterdam, pp. 113–145.
- Ortlieb, L. (1995) El Niño events and the occurrence of rainfall episodes in the Atacama Desert: the record during the last two centuries [in Spanish]. *Bull. Inst. Français Etudes Andines* 24, 519–537.
- Rundel, P.W., Dillon, M.O., Palma, B., Hooney, H.A., Gulmon, S.L., and Ehleringer, J.R. (1991) The phytogeography and ecology of the coastal Atacama and Peruvian deserts. *Aliso* 13(1), 1–49.
- Rutllant, J. and Ulriksen, P. (1979) Boundary layer dynamics of the extremely arid northern part of Chile: the Antofagasta Field Experiment. *Boundary Layer Meteorol.* 17, 41–55.
- Rutllant, J., Fuenzalida, H., Torres R., and Figueroa, D. (1998) Ocean-atmosphere-land interaction in the Antofagasta Region (Chile, 23 S): the DICLIMA field experiment [in Spanish]. *Rev. Chilena Historia Natural* 71, 405–427.
- Rutllant, J., Fuenzalida, H., Aceituno, P., Montecinos, A., Sanchez, R., Salinas, H., Inzunza, J., and Zuleta, R. (2000) Coastal climate dynamics of the Antofagasta region (Chile, 23 S): the 1997–1998 DICLIMA experiment. In *6th International Conference on Southern Hemisphere Meteorology and Oceanography, Santiago, 3–7 April 2000*, American Meteorological Society, Boston, pp. 268–269.
- Takayabu, Y.N., Iguchi, T., Kachi, M., Shibata, A., and Kanzawa, H. (1999) Abrupt termination of the 1997–98 El Niño in response to a Madden-Julian oscillation. *Nature* 402, 279–282.
- Trewartha, G.T. (1961) *The Earth's Problem Climates*, University of Wisconsin Press, Madison.
- Ulloa, O., Escribano, R., Hormazabal, S., Quiñones, R.A., González, R.R., and Ramos, M. (2001) Evolution and biological effects of the 1997–98 El Niño in the upwelling ecosystems off northern Chile. *Geophys. Res. Lett.* 28, 1591–1594.

- Vargas, G., Ortlieb, L., and Rutllant, J. (2000) Historic mudflows in Antofagasta, Chile, and their relationship to the El Niño/Southern Oscillation events [in Spanish]. *Rev. Geol. Chile* 27, 157–176.
- Vogel, S. (1955) "Fensterpflanzen" in der südafrikansichen Wüste, eine ökologische Schilderung. *Beitr. Biol. Pfl.* 31, 45–135.

Address reprint requests to:
Dr. Christopher P. McKay
Space Science Division
NASA Ames Research Center
Moffett Field, CA 94035
E-mail: cmckay@arc.nasa.gov