

Tensile Behavior of Cement-Based Composites with Random Discontinuous Steel Fibers

Victor C. Li, Hwai-Chung Wu,* Mohamed Maalej, and Dhanada K. Mishra

ACE-MRL, Department of Civil and Environmental Engineering, The University of Michigan, Ann Arbor, Michigan 48109-2125

Toshiyuki Hashida

Research Institute for Fracture Technology, Tohoku University, Sendai 980, Japan

In this paper, the tensile properties of cement-based composites containing random discontinuous steel fibers are reported. Direct tensile tests were performed to study the effects of fiber length (hence fiber aspect ratio), interfacial bonding, and processing conditions on composite properties. Composite tensile strength and ductility are highlighted and discussed.

I. Introduction

FIBER reinforcement has been employed in various concrete structures in the past few decades. In thin sheet products, fiber reinforcement is often employed to improve flexural performance.¹ For bulk structures, fibers have been largely used for the suppression of plastic shrinkage cracking.^{2,3} Fibers have also been used to increase impact resistance in concrete structures.^{4,5} Improvements in tensile properties are often related to enhancement of fracture toughness associated with tension softening and fiber pull-out across an opening crack. Composite tensile or compressive strength, and tensile ductility, typically remain unchanged.²

In 1971, Aveston *et al.*⁶ demonstrated that composite tensile strength and ductility can be significantly enhanced by the use of aligned continuous fibers. Since then, many experimental results have shown this pseudo-strain-hardening behavior in composites using both continuous and discontinuous fibers. For discontinuous fiber composites, the fiber volume fraction used typically is high (e.g., SIFCON⁷). Recent theoretical modeling of pseudo-strain-hardening in discontinuous random fiber reinforced composites^{8,9} provides guidelines for selection of individual materials constituents (fiber, matrix, and interface) and fiber geometry (fiber diameter and aspect ratio) to achieve desirable composite performance.

In this paper, direct tensile test results of cement-based matrix composites reinforced with short random steel fibers are reported. Special attention is given to composite tensile strength and ductility. Ductility in this paper refers to the strain value at ultimate tensile stress, and as such, is a material property independent of measurement gage length. The composite constituent parameters under study include fiber volume fraction, fiber length, and interface bond strength. These preliminary results suggest that it is possible to achieve strain-hardening in steel-fiber-reinforced concrete with moderately small fiber volume fraction. However, these test results also indicate to us

that direct tension test results must be carefully interpreted, and improved testing procedures are suggested.

II. Experimental Program

A series of tests were carried out to study the effects of microparameters on composite tensile behavior as discussed above. Fiber length is controlled by the use of a laboratory fiber cutting machine and adjusting the cutter speed on a continuously fed wire. Interfacial bond properties are controlled by the addition of a coupling agent to the mix and by the use of variable vibration frequency during casting. More details of the coupling agent and vibration frequency will be given later. Direct tensile tests were performed using coupon tensile specimens. The plain matrix materials were also tested for pertinent information. At least three tensile plate specimens were tested in each case.

(1) Materials

The mix proportion of the matrix and the composite are shown in Table I. All of the mix proportions are by weight of the ingredients. Discontinuous steel fibers (trade name Dramix) with various fiber lengths and volume fractions are employed in this study. This steel fiber is brass-coated with a diameter of 150 μm ; fiber properties are tabulated in Table II.

(2) Specimen Preparation

The tensile specimen is in the form of a rectangular coupon of size 304.8 mm \times 76.2 mm \times 12.7 mm. The molds used to cast the specimens are made of plexiglass. The mixing procedure of the composite materials consists of the following steps:

(A) *Premixing Stage:* In this stage the matrix is carefully prepared in the regular Hobart type of mixer. The silica fume (in solution form) is first mixed either by hand or by a small mixer to make a uniform mixture and poured into the mixing bowl. The cement is added next. The water and the superplasticizer are mixed together along with a coupling agent if necessary. The dosage of the coupling agent used in this study is 0.25% by weight of the cement. This mixture is then slowly added while the cement and silica fume are mixed at a slow speed. This procedure takes 3-5 min and results in a uniform fluid matrix. The bottom of the mixing bowl may be scraped manually to ensure that no material sticks to the bottom. After such scraping the matrix may be mixed at a higher speed for 1 min before addition of fibers.

(B) *Addition of Fibers:* The fibers are added manually as the matrix is mixed at a slow speed. To ensure proper distribution, the fibers must be added slowly over a period of about 10 min for high fiber loading such as 7% by volume of the 6-mm-long fibers. For the fiber length used in this study, visual inspection of the mix at the end of fiber addition reveals good fiber dispersion.

(C) *Casting Composite Materials:* The composite material is carefully placed in the mold and compacted. The casting

B. R. Lawn—contributing editor

Manuscript No. 193601. Received May 9, 1994; approved October 16, 1994. Supported in part by a grant (MSS-9301949) from the National Science Foundation to the University of Michigan.

*Member, American Ceramic Society.

Table I. Mix Proportions (by weight)[†]

MIX	Cement	FA	CA	SF	SP	W
PC	1	1.72	1.73	0	0	0.45
CP	1	0	0	0.2	0.03	0.27
Composite	1	0	0	0.2	0.03	0.27

[†]PC = plain concrete, CP = cement paste, composite = engineered cementitious composite, cement = ordinary type I, FA = fine aggregate, CA = coarse aggregate, SF = silica fume (in solution form containing 51% water), SP = super plasticizer (in solution form containing 66% water), W = water.

of composite material is carried out using high-frequency vibration. The shake table used for this purpose has a high-frequency vibrator, with a frequency range of 0 to 150 Hz. For most composite casting operations, a frequency of vibration of about 120 Hz (designated as high frequency) is applied to the mold placed on the table top. To study the effect of the application of high-frequency vibration, 60 Hz frequency was also used in casting some of the specimen. This is referred to as the normal frequency vibration. The workability of the mix has been designed to be such that segregation or bleeding is avoided in spite of the use of high-frequency vibration.

(D) *Curing and Testing Age:* To prevent loss of moisture, the specimens are covered with polyethylene sheets and stored for 24 h prior to demolding. All specimens are then placed into water curing tanks at room temperature for 4 weeks. They are approximately 5 to 6 weeks old at testing.

(3) Testing Procedures

The coupon specimens were tested in uniaxial tension under displacement control in a 133.5 kN capacity MTS 810 material testing system with hydraulic wedge grips. The displacement rate used was 0.005 mm/s. Aluminum plates were epoxy glued onto the ends of the tension specimens to facilitate gripping. Care was taken to ensure proper alignment of the specimens with the machine hydraulic grips. The MTS machine has a fully digital control panel and Teststar software to automatically run the tests and collect the load and actuator displacement data. In addition, two LVDTs connected to a data acquisition system were used to measure displacements between two points on the specimen at a gage length of 205 mm (Fig. 1). The data acquisition system consists of a Schaevitz LVDT signal conditioner and a Labtech Notebook software. The tensile behavior can then be determined from these tests.

III. Results and Discussion

(1) Matrix Properties

The plain matrix made by cement hydration with or without aggregates is very brittle. Cementitious materials are flaw sensitive and the tensile strength is normally governed by the maximum inherent flaw size.¹⁰ The flaw size and distribution are in turn dependent on the water/cement ratio, packing density, and processing conditions. Typical stress-strain experimental curves are shown in Fig. 2 for a plain matrix specimen, i.e., plain concrete and cement paste. As can be observed there is not much difference in terms of the strain capacity (in the range of 0.02% to 0.04%) of these materials. There is no difference between the first crack strength and the ultimate strength since unstable crack propagation leads to immediate failure. However, the ultimate strength of plain concrete is almost 2 times that of the cement paste alone. This is mainly because of the crack arresting as well as bridging effect of aggregates.¹¹ There is also a significant difference in the modulus of the two materials as the aggregates in the concrete materials are much stronger

and stiffer than the cement paste. The toughness J_c of these two plain matrices has been measured by fracture tests to be 0.007–0.01 and 0.025–0.030 kJ/m² for cement paste and plain concrete, respectively. Micromechanical model of strain-hardening¹² suggests that the cement paste with lower toughness (in comparison to concrete) should require a smaller number of fibers to make the transition from brittle to pseudo-strain-hardening mode of failure.

(2) Effect of Fiber Volume Fraction

Recent experimental data on composite porosity indicate an increasing trend of total porosity with respect to increased fiber volume fraction. The total porosity of a cement paste reinforced with 4 vol% polyethylene fibers is found to be 2 times higher than that of plain cement paste. As a consequence, fiber-induced matrix porosity may affect several microparameters of the composite. In particular, matrix modulus E_m , toughness J_c , and interfacial bond strength τ may be reduced. Direct and indirect evidence of cementitious matrix property modifications due to the addition of a second phase material can be found in the literature.^{13,14} Hence, properties determined from specimens of the plain matrix may not reflect accurately the actual values of the "matrix" properties inside a composite. Instead they should be regarded as approximate estimates only and should be understood as being influenced by the presence and number of fibers.

Figure 3 depicts the composite tensile behavior with various fiber volume fractions. These composites are cast under normal-frequency vibration (60 Hz). The strength improvements over

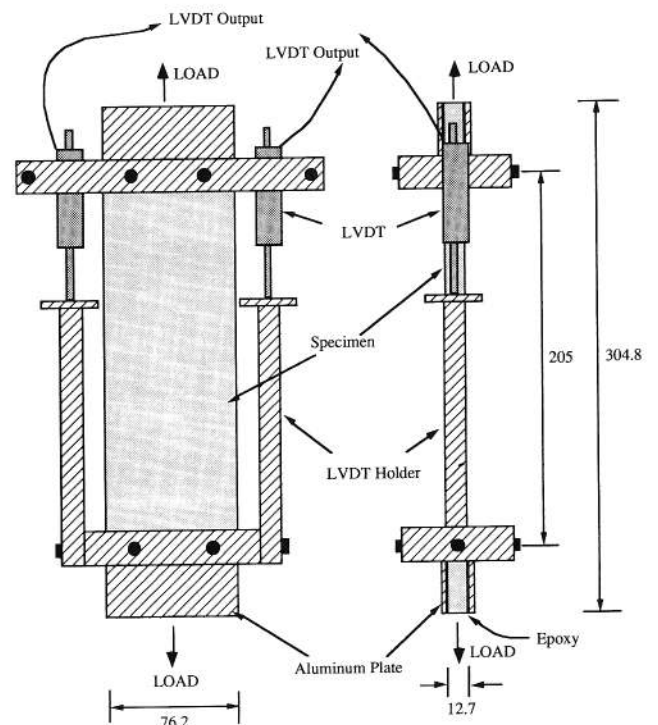

All dimensions are in mm

Table II. Dimensions and Mechanical Properties of Steel Fibers

d_f (μm)	L_f (mm)	E_f (GPa)	σ_{fu}^* (MPa)	ρ (Mg/m ³)
150	6, 12, 16, 20	200	2500	7.8

*Ultimate strength.

Fig. 1. Tensile coupon with LVDT holder mounted before test.

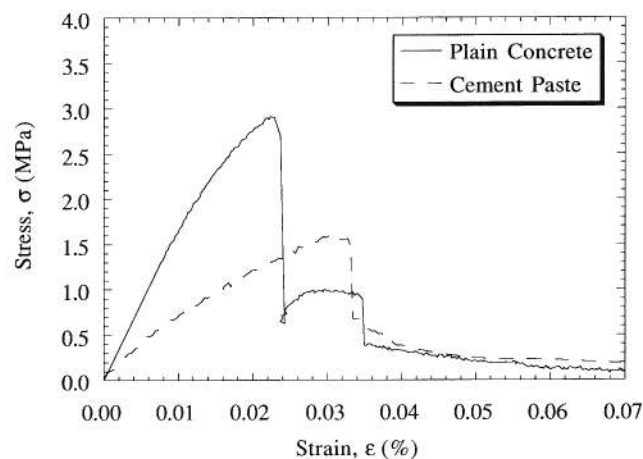

Fig. 2. Tensile behavior of plain matrix.

the plain matrix are 38%, 160%, and 400%, respectively, for $V_f = 3.6\%$, 7%, and 10%. Moreover, the ultimate strain capacities are enhanced 67%, 100%, and 833%, respectively, by adding fiber reinforcements.

(3) Effect of Aspect Ratio

Figure 4 shows the stress–strain curves for four composites with fiber lengths of 6, 12, 16, and 20 mm, corresponding to aspect ratios of 40, 80, 107, and 133, respectively. The specimens were cast under high-frequency vibration, the effect of which will be discussed in the next section. The fiber volume fraction for each fiber length was selected so as to maintain roughly the same workability and uniformity of the fresh mix without altering the properties of the matrix. As shown in Fig. 4, the reinforcement becomes more efficient as the fiber length is increased. For instance, by increasing the fiber length from 6 to 20 mm, the tensile strength of the composite (peak stress of stress–strain curve) was maintained at about 6 MPa although the fiber volume fraction was reduced from 7% to 1.3% (keeping in mind that the unreinforced matrix has a tensile strength about 1.5 MPa). In addition, all composites show a clear pseudo-strain-hardening behavior. Further, the longer fibers (16 and 20 mm) gave the composite a larger strain capacity. Multiple cracking (up to seven cracks by unaided visual examination) was also observed on these composites during

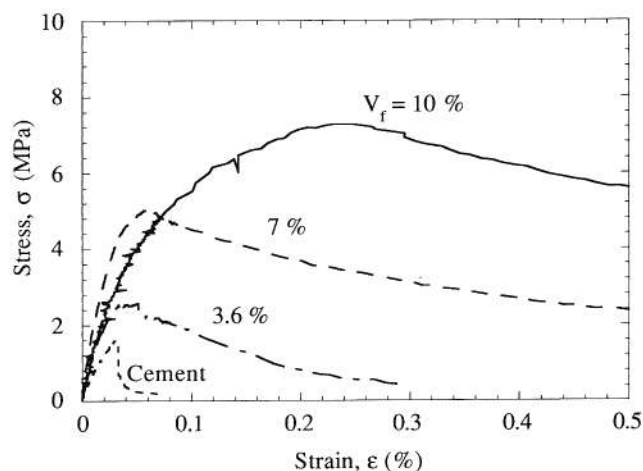

Fig. 3. Tensile stress–strain curves of plain and steel-fiber-reinforced cement with various fiber volume fractions ($L_f = 6$ mm). Specimens cast under normal-frequency vibration.

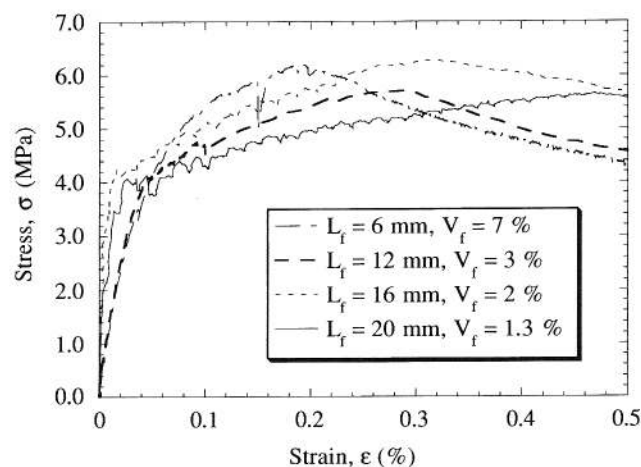

Fig. 4. Effect of fiber length (or aspect ratio) on tensile stress–strain behavior. Specimens cast under high-frequency vibration.

loading. This is quite remarkable given the low fiber volume fractions of these composites (less than or equal to 2%).

The longer fibers may produce a bias for fiber orientation. Since the specimen thickness is only 12.7 mm, the fiber orientation within the matrix for the 16 mm and the 20 mm fiber composites is mostly two-dimensional. However, theoretical calculation¹³ indicates that the effect of 2-D versus 3-D fiber orientation on tensile properties is relatively minor, making a difference of less than 10%.

(4) Effects of Bond Strength

(A) *Vibration Frequency during Casting:* In addition to fiber aspect ratio, high bond strength is another useful means of enhancing composite properties. One effective way of improving bond strength is by high-frequency vibration during casting, presumably due to better geometric packing. Figure 5 shows the tensile stress–strain curves of specimens with two different V_f (but the same fiber length of 6 mm) cast under two different vibration frequency compactations, namely normal- and high-frequency (60 and 120 Hz, respectively). In the cases of $V_f = 7\%$, significant strain increase (2.3 times) and moderate strength increase (24%) are achieved when high-frequency vibration is applied. The composites of $V_f = 10\%$ have shown increased strain capacity even when they are cast under normal-frequency vibration. For these composites ($V_f = 10\%$), the strength and strain are increased about 60% and 45%, respectively, when a high-frequency vibration is employed instead of normal-frequency. This gain in strength and strain is probably due to enhanced bond strength by the use of high-frequency vibration.

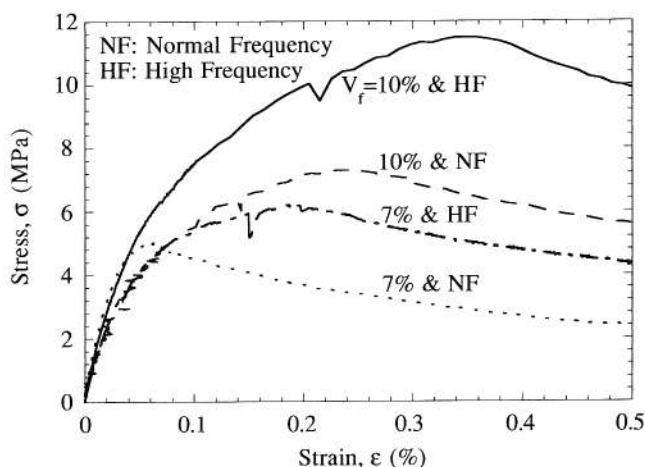

Fig. 5. Effect of vibration frequency during casting on tensile stress–strain curves for two different fiber volume fractions ($L_f = 6$ mm).

These results are consistent with recent single-fiber pull-out experimental findings¹⁵ that when the interfacial zone is compacted, the bond strength increases for brass fibers in cementitious matrices. In the work of Chan,¹⁵ compaction was achieved by the use of microfillers (silica fume and change in water/cement ratios) whereas compaction is achieved by higher vibration frequency in the present experiments.

(B) *Coupling Agent*: In our recent efforts toward enhancing interfacial bonding through fiber surface modification, a titanium-based coupling agent was used in the steel fiber composites. The coupling agent was added in an attempt to create "molecular bridges" at the interface, hence leading to improved bond strength. It was added to the cement paste prior to addition of steel fibers at a dosage of 0.25% by weight of cement. As shown in Fig. 6, a 26% and 233% increase in composite ultimate strength and strain are achieved respectively with the coupling agent compared to that of the plain composite when a normal-frequency vibration is used during specimens casting for both composites. No further improvement was found with a high-frequency vibration. Also, from preliminary results of single-fiber pull-out tests, the interfacial bond strength remains the same with or without the coupling agent.¹⁵ These results suggest that the current coupling agent may act as a rheology aid to improve workability and therefore interfacial bond strength. Hence it is more evident in the specimens cast under normal-frequency vibration. It is worth noting that no workability problem exists for a single-fiber specimen, but workability becomes a severe problem in the high-fiber-loaded composites. The net result is that a coupling agent or high-frequency vibration reverses the bond strength deterioration caused by high fiber loading. Further study is currently in progress.

(5) Combined Effects

The experiments presented in this paper illustrate how the tensile properties of steel fiber cementitious composites can be improved by controlling the microparameters, while maintaining low fiber volume fraction. In fact, based upon the discussion above, it is concluded that improved composite properties can be achieved by the simultaneous use of longer fibers, a coupling agent, and high-frequency vibration. The solid line in Fig. 7 shows a stress-strain curve for a composite where the fibers are 16 mm long and the fiber volume fraction is 2.3%. The composite was prepared using a coupling agent and high-frequency vibration. When the stress-strain curve for this composite is compared to the one shown in Fig. 4 for the 16 mm fiber composite, it is seen that by increasing the fiber volume fraction by 15%, the ultimate tensile strength was increased by approximately 30%. This disproportionate increase in ultimate tensile strength may be attributed to

enhanced workability by the use of a coupling agent. In addition, the ultimate tensile strain increased by almost 50%. Further, the stress-strain curve for this composite clearly shows better performance in terms of ultimate tensile strength and strain capacity, when compared to typical stress-strain curves reported for plain concrete and steel-fiber-reinforced concrete¹⁶ of comparable fiber volume fractions (shown in dotted lines in Fig. 7).

IV. Further Discussions and Conclusions

It has been demonstrated in this paper that apart from fiber volume fraction, judicious choice of other fiber, matrix, and interface microparameters can be advantageous in high-performance cementitious composite design. Specifically, it is shown experimentally that with high fiber aspect ratio and bond strength, enhanced tensile strain-capacity can occur in steel-fiber-reinforced cement-based composites at a reasonably low fiber volume fraction. As a result, the ductility of the composite can increase by as much as an order of magnitude. For example, the composite with 2.3 vol% of fibers of 16 mm in length, processed with a coupling agent and high-frequency vibration, reaches a tensile strain of 0.5%, compared to the matrix strain capacity of 0.03%.

The experimental results suggest that processing control can be critical in achieving desirable composite properties. Specifically, these preliminary data indicate that excessive increase of fiber volume fraction may lead to interface bond deterioration and matrix property degradation. Addition of a titanium-based coupling agent to fresh mix and high-frequency vibration casting are found to be effective means of reversing the bond deterioration tendency in high fiber volume fraction composites. Finally, it should be understood that the effect of fiber volume fraction, fiber length, vibration frequency during casting, and addition of coupling agents, on composite properties revealed in the experiments reported here may be sensitive to the type of fiber used. This is especially so for the vibration frequency and coupling agent effects.

Based on the macroscopic tensile stress-strain curves reported here, it is tempting to associate the improved strain-capacity of the composites with higher fiber volume, longer fiber length, or improved bond property to multiple cracking behavior.⁶ However, careful examination of the surface of the failed specimens, with the possible exception of the longer fiber (above 6 mm) ones, reveals that most failures occur with only one or two cracks, usually starting from the edge of the specimens. In addition, micromechanical calculations based on reasonable parametric values for this set of composite (fiber

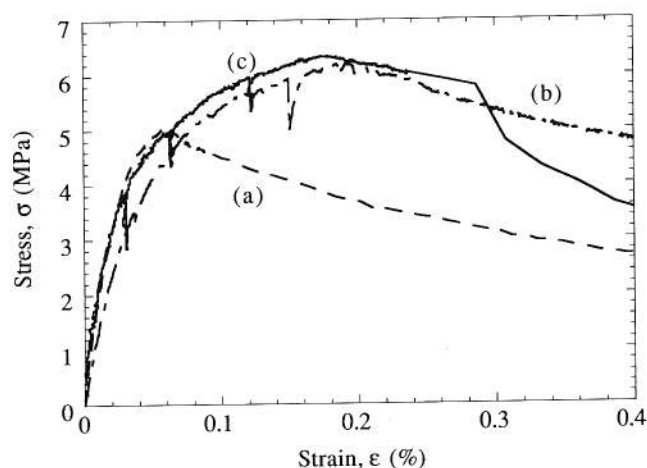

Fig. 6. Tensile stress-strain curves for composites with $V_f = 7\%$ and $L_f = 6$ mm; (a) without coupling agent, normal-frequency vibration; (b) with coupling agent, normal frequency vibration; and (c) with coupling agent, high-frequency vibration.

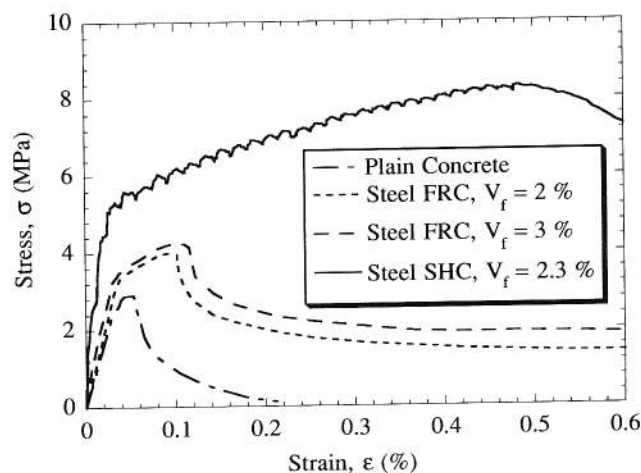

Fig. 7. Comparison between the tensile stress-strain response of strain-hardening cementitious composite (SHC, this study) and that of plain concrete and steel fiber reinforced concrete (after Soroushian and Bayasi¹⁶).

modulus = 200 GPa; matrix modulus = 15 GPa; interface bond strength = 1.8 MPa) suggest that the short fiber with an aspect ratio of 40 could not possibly have achieved critical conditions for strain-hardening.¹⁷ It is therefore argued that the apparent "strain-hardening" behavior revealed in the macroscopic stress-strain curve is likely a result of stabilized edge crack propagation. This means that the instability of an edge crack is greatly delayed by the presence of the steel fibers as the edge crack propagates with *R*-curve behavior.¹⁸ To balance the rotational moment of an edge crack, a new edge crack is often created on the opposite side of the specimen, as a result of the rotational rigidity of the specimen grip.

While all composites show significant improvement in strength and "ductility," we conclude that only the longer fiber composites shown in Figs. 4 and 7 in this test series undergo pseudo-strain-hardening. Although multiple cracking was observed during the test of these composites, these cracks disappeared after specimen unloading. From this study, new insights into uniaxial testing of strain-hardening materials can be derived: (1) For tensile strength testing of brittle material, rotational rigidity is preferred. For strain-hardening material, complete rotational flexibility is preferred since by definition, the strain-hardening effect of the material should create multiple cracks to maintain rotational balance. In contrast, a brittle or quasi-brittle material with stabilized cracks will continue to open the first edge crack, leading to a distinct flexural failure mode which can be well detected from differential displacement measurements by LVDTs maintained on both edges of a specimen. (2) Techniques in damage pattern monitoring such as dye epoxy impregnation¹⁹ should be employed in order to freeze the multiple crack pattern while the specimen is still under load. Adopting these techniques should provide better means of distinguishing the mode of failure in these composites which are at the borderline between quasi-brittleness and quasi-ductility.

Acknowledgments: The Dramix steel fibers used in the experiments described in this paper have been provided by Bekaert Corp., Belgium. Special thanks are due to Mr. M. Vandenberghe and Mr. P. Tatnall at Bekaert Corp. Helpful discussions with Dr. H. Stang are acknowledged.

References

¹G. Xu and D. J. Hannant, "Flexural Behavior of Combined Polypropylene Network and Glass Fiber Reinforced Cement," *Cem. Concr. Compos.*, **14**, 51–61 (1992).

²S. P. Shah, "Toughening of Cement-Based Materials with Fiber Reinforcement," *Mater. Res. Soc. Symp. Proc.*, **211**, 3–13 (1991).

³S. P. Shah, "Do Fibers Improve the Tensile Strength of Concrete?"; pp. 10–30 in Proceedings of the First Canadian University-Industry Workshop on Fiber Reinforced Concrete (Quebec, Canada, October, 1991). Edited by N. Banthia. University Laval, Quebec, Canada, 1991.

⁴S. Mindess, N. Banthia, and C. Yan, "The Fracture Toughness of Concrete under Impact Loading," *Cem. Concr. Res.*, **17**, 231–41 (1987).

⁵S. Mindess, A. Bentur, C. Yan, and G. Vondran, "Impact Resistance of Concrete Containing Both Conventional Steel Reinforcement and Fibrillated Polypropylene Fibers," *ACI Mater. J.*, **86** [6] 545–49 (1989).

⁶J. Aveston, G. A. Cooper, and A. Kelly, "Single and Multiple Fracture"; pp. 15–24 in *Properties of Fiber Composites*, Conference Proceedings, National Physical Laboratory, IPC Science and Technology Press Ltd., Guildford, U.K., 1971.

⁷A. E. Naaman and J. R. Homrich, "Tensile Stress Strain Properties of SIFCON," *ACI Mater. J.*, **86** [3] 244–51 (1989).

⁸V. C. Li and C. K. Y. Leung, "Theory of Steady State and Multiple Cracking of Random Discontinuous Fiber Reinforced Brittle Matrix Composites," *ASCE J. Eng. Mech. Div.*, **118** [11] 2246–64 (1992).

⁹V. C. Li and H. C. Wu, "Conditions for Pseudo Strain-Hardening in Fiber Reinforced Brittle Matrix Composites," *Appl. Mech. Rev.*, **45** [8] 390–98 (1992).

¹⁰J. D. Birchall, "The Chemistry and Physics of Strong Cement Bodies," *Ind. Chem. Bull.*, 187–90 (1983).

¹¹J. Huang and V. C. Li, "A Meso-mechanical Model of the Tensile Behavior of Concrete—Part I: Modeling of Pre-peak Stress-Strain Relation," *J. Compos.*, **20** [4] 361–69 (1989).

¹²V. C. Li and H. C. Wu, "Micromechanics Based Design for Pseudo Strain-Hardening in Cementitious Composites"; pp. 740–43 in *Engineering Mechanics*, Proceedings of the ASCE Ninth Engineering Mechanics Conference (College Station, TX, May 1992). Edited by L. D. Lutes and J. M. Niedzwecki. American Society of Civil Engineers, New York, 1992.

¹³H. C. Wu and V. C. Li, "Snubbing and Bundling Effects on Multiple Crack Spacing of Discontinuous Random Fiber Reinforced Brittle Matrix Composites," *J. Am. Ceram. Soc.*, **75** [12] 3487–89 (1992).

¹⁴V. C. Li, "A Simplified Micromechanical Model of Compressive Strength of Fiber Reinforced Cementitious Composites," *J. Cem. Concr. Compos.*, **14** [2] 131–41 (1992).

¹⁵Y. W. Chan, "Fiber/Cement Interfacial Bond Property Modification in Relation to Interfacial Microstructure"; Ph.D. Thesis. University of Michigan, Ann Arbor, MI, 1994.

¹⁶P. Soroushian and Z. Bayasi, "Prediction of the Tensile Strength of Fiber Reinforced Concrete: A Critique of the Composite Material Concept"; pp. 71–84 in *Fiber Reinforced Concrete Properties and Applications*, ACI SP-105. Edited by S. P. Shah and G. B. Batson. American Concrete Institute, Detroit, MI, 1987.

¹⁷V. C. Li, "From Micromechanics to Structural Engineering—The Design of Cementitious Composites for Civil Engineering Applications," *J. Struct. Mech. Earthquake Eng.*, **10** [2] 37–48 (1993).

¹⁸B. Cotterell and Y. W. Mai, "Modeling Crack Growth in Fiber Reinforced Cementitious Materials," *Mater. Forum*, **11**, 341–51 (1988).

¹⁹H. Stang, B. Mobasher, and S. P. Shah, "Quantitative Damage Characterization in Polypropylene Fiber Reinforced Concrete," *Cem. Concr. Res.*, **20**, 540–58 (1990). □