

TERRESTRIAL 3D LASER SCANNING – DATA ACQUISITION AND OBJECT MODELLING FOR INDUSTRIAL AS-BUILT DOCUMENTATION AND ARCHITECTURAL APPLICATIONS

H. Sternberg^a, Th. Kersten^a, I. Jahn^b, R. Kinzel^b

^a Department of Geomatics, Hamburg University of Applied Sciences, Hebebrandstr. 1, D - 22297 Hamburg, Germany
[h.sternberg, t.kersten]@rzcn.haw-hamburg.de

^b GDV Ingenieurgesellschaft Holst mbH, Tremskamp5, D - 23611 Bad Schwartau, Germany
[gdv_kinzel, gdv_jahn]@t-online.de

ISPRS ThS-17 Laser Scanning Acquisition and Modelling Techniques

KEY WORDS: Accuracy, Application, Cultural Heritage, Industrial, Laser scanning, Terrestrial, Three-dimensional

ABSTRACT:

In this paper the investigations of two projects using the terrestrial 3D laser scanning system "CYRAX 2500®" from Leica Geosystems are presented. The CYRAX 2500 is tested in 3D data acquisition and object modelling for industrial as-built documentation and for an architectural application. The major aspects of these investigations were the accuracy of point determination and object modelling, the degree of automation in data acquisition and object modelling, and consequently the overall efficiency of the laser scanning system and its related software tools. With the scanner the two objects were recorded three-dimensionally as point clouds. The registration and modelling of the industrial facilities (pipelines of the company Boie in Lübeck, Germany) could be performed nearly automatically with the software *Cyclone* (version 4.0.2), which belongs to the scanning system. The modelling of the architectural object (Holstentor in Lübeck) had to be carried out mostly manually in combination with the CAD program AutoCAD. The two projects demonstrated that the Cyrax laser scanning system is especial suitable for detailed 3D recording and modelling of industrial facilities. Due to its measuring precision and its high point density, the Cyrax 2500 represents a good alternative and supplement to classic construction surveying and to photogrammetric data acquisition. The two projects described were performed in cooperation between the Hamburg University of Applied Sciences, Department of Geomatics, and the engineering office GDV Ingenieurgesellschaft Holst mbH, Bad Schwartau, Germany.

1. INTRODUCTION

Recent developments in computer technology provide continually updating possibilities for creating virtual 3D models or worlds. Since the 1990's terrestrial laser scanners are increasingly available on the market as an efficient 3D measurement system in competition with or as an alternative option to photogrammetry and/or geodetic methods. Terrestrial laser scanners offer the fascinating possibility of measuring millions of points within short time periods. Thus, it is possible to record complete 3D objects efficiently. These systems are beginning to dominate the market in a range of applications such as in the mining industry, industrial as-built-documentation, archaeology, architecture, care of monuments, automobile and mechanical engineering, and also in creation of virtual scenes, e.g. single objects as points of interest for 3D guiding assistance of car navigation systems. However, detailed investigations into accuracies and behaviour of such measuring systems must show whether these systems fulfil various project requirements and whether the technical specifications indicated by the system manufacturers are correct. Some authors (Boehler et al. 2003, Johansson 2003, Lichti et al. 2003, and Kersten et al. 2004) have already reported first investigations into terrestrial laser scanners, while publications about experiences with laser scanners are summarized in the conference proceedings of the "Oldenburger 3D-Tage" (Luhmann 2002, Luhmann 2003, Luhmann 2004) and the Optical 3D-Measurement Techniques V and VI (Gruen and Kahmen 2001, Gruen and Kahmen 2003).

2. SCANNING OBJECTS

Two objects for different applications were scanned in order to judge the versatility and performance of terrestrial laser scanners. The recording of industrial pipelines of the company Boie in Lübeck (Fig. 1) represents an example of as-built documentation, while the scanning of the Holstentor in Lübeck (Fig. 2) is an example of the recording of historical buildings (cultural heritage).

2.1 Industrial Facility

The company Boie in Lübeck stores liquid propane on an area of approx. 100m x 100m up to 2000m³. The pipelines run from 4 underground tanks over approx. 200m length to the filling stations (Fig. 1).

Maps of these facilities were so far only available in analogous form and as abstract flow patterns. A map of the terrain was generated by conventional tacheometric measurements through the surveying office Holst und Helten, Bad Schwartau at map scale 1:500. A geo-referenced 3D model of the facilities was generated from laser scanner data in project processing that is also suitable for virtual planning and reconstruction measures.

2.2 Historical Building (Cultural Heritage)

The Holstentor (Fig. 2), a landmark of the Hanseatic city Lübeck, is one of the best known medieval architectural monuments in Northern Germany. The double-towered gate

was built between 1464 and 1478 as a part of a modernized fortification structure. In 1863 it escaped demolition with a majority of only one voice in a vote by the citizens of Lübeck (SCHADENDORF 1977). Today the Holstentor is a tourist attraction of the Hanseatic city Lübeck due to its national fame. The Holstentor was founded with its basic ground area of approx. 34m x of 12m and its height of approx. 39m on a bar rust construction, which rests on stakes in peat and marshy soil. The aim of the laser scanner recording at the Holstentor was the geometrically exact modelling of the building construction substance, which was already deformed during the construction phase. A detailed description of the project and the results are summarized in Jahn, 2003.



Figure 1. Pipelines of the company Boie GmbH in Lübeck



Figure 2. Western facade front of the Holstentor, Lübeck

3. THE 3D LASERSCANNING SYSTEM CYRAX 2500®

The 3D laser scanning system *Cyrax 2500* from Cyra, California, USA is one of the most precise terrestrial laser scanning system, which has become available on the market in recent years. Today the *Cyrax 2500* is renamed to “HDS2500” as a part of the laser scanner series “High Definition Survey” from Leica Geosystems.

The system permits non-contact object recording at a scale of 1:1 with a freely selectable point grid of up to 1.2mm. The scanning rate is 1000 points per second. The diversion of the laser beam is carried out over two rotatable mirrors in a measuring window of 40° x 40° (Camera View). By means of an optical system the focusing of the measuring beam is set to a diameter of 6mm at a distance of 50m. The 3D coordinate precision is ±6mm at a measuring distance of 50m. In addition to the geometric information, an intensity value is stored as a fourth coordinate. Thus, the representation of the point cloud is color-coded on the basis of the intensity values (CYRA 2003a).

The post processing of the data (3D point clouds) was performed with the modular software package *Cyclone*. The *Cyclone* software module *model* controls the scanning parameters during the data acquisition phase and allows the registration of the point clouds as well as the 2D- and 3D evaluation. With the COE (Cyra Object Exchange) data format, the loss-free data flow can be carried out to the CAD programs AutoCAD and MicroStation. Using the plug-in *CloudWorx* for both CAD programs the operator can work on the point clouds using the well-known user interfaces, while millions of points are managed in the background by the *Cyclone* software. The basis for the use of *Cyclone* version 4.0.2 in the project processing phase was a three-day system and software training (CYRA 2003b) completed by one of the authors.

4. RECORDING OF PIPELINES OF THE COMPANY BOIE IN LÜBECK

4.1 Data Acquisition

Before scanning a local geodetic network was determined, which was supposed to be used for the subsequent geo-referencing of the different scans. Therefore, all geodetic measurements were conducted with the total station TCRA 1105 plus from Leica Geosystems. After the final 3D network adjustment the data acquisition with the laser scanner was accomplished on two workdays. During the scanning phase Cyra targets (Fig. 3), which were well distributed in object space, were measured with the total station and determined in the local network coordinate system for the geo-referencing of the point clouds.

The recording of the complete object by the laser scanning system (Fig. 4) required eight different scanner stations, which supplied 20 scans in total using a grid width of 1.5cm. Thus, most pipings in the object space could be modeled in the evaluation phase, due to the available pipe diameters between 4cm and 12cm. The measuring distance was between 20m and 30m on average, therefore the precision potential of the laser scanner, which refers to a measuring distance of 50m, could be met. In total 11 million points were scanned, which yielded a file storage size of 257 MB.

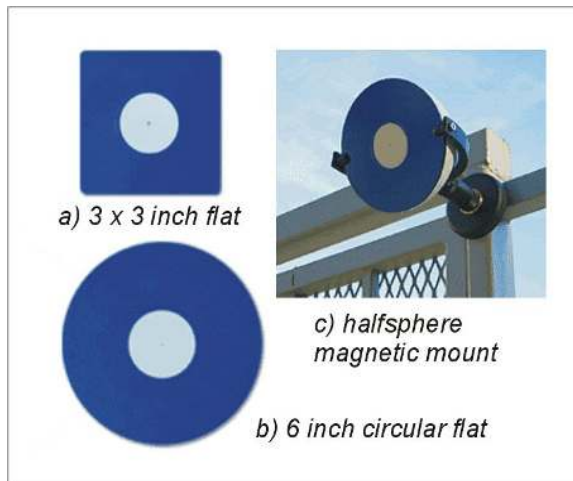

Figure 3. Cyra Targets

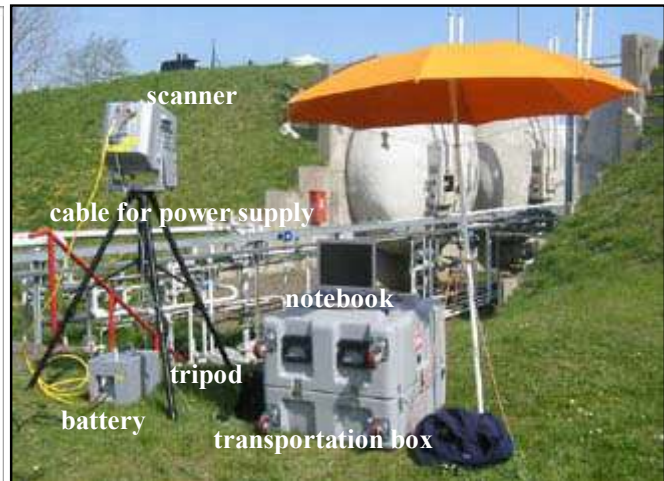

Figure 4. 3D Laser Scanning System CYRAX 2500 at Boie Lübeck

4.2 Data Processing

The data processing was carried out exclusively in the Cyclone software modules. The first step of the processing was the transformation of all point clouds from the local scanner coordinate system into the common coordinate system (registration). This processing step was performed in the Cyclone software by a 3D Helmert transformation without a scaling factor (CYRA 2003b.) A strict adjustment with identical points is not provided in the software.

Three processes are available for the registration of point clouds: Firstly, all point clouds could be registered using only suitable overlap areas with a precision of 8mm; Secondly, the registration can be supported by the use of ten targets as tie points, which are scanned from different stations (the mean distance to these matched targets (tie points) was 1mm); Finally, the transformation of the point cloud into the local geodetic network could be performed by eight scanned control points, which were determined with a standard deviation of 1mm using a total station. However, six targets, which were well distributed in object space, were used as check points. On average the difference from the check point coordinates, which were determined by the total station, was better than 5mm.

Scanning and registration were carried out as an automated process using the Cyra targets (Fig. 3). These targets were already recognized semi-automatically by the software during the scanning phase. Unfortunately, the construction of the Cyrax 2500 as a camera view scanner with a limited field of view was a disadvantage for the measurement of long stretched pipelines, which required several additional scans, each with an overlap of 1/3 of the scanning area.

Finally, a 3D CAD model of the pipelines (Fig. 6) was generated from the registered and geo-referenced point cloud. For the evaluation, single parts of the point cloud were selected manually to approximate geometrical primitives (in general cylinders) in the selected and processed data. The thus generated single CAD elements were subsequently bound to a complete 3D model. Using check points measured with a total station a precision of better than 10mm could be achieved for the 3D model. The processing time needed for the generation of the 3D model was 111 work hours in total.

5. RECORDING OF THE HOLSTENTOR LÜBECK

5.1 Data Acquisition

The recording of the Holstentor in Lübeck was carried out in the local scanner coordinate systems, i.e. no Cyra targets were used for registration and geo-referencing of the point clouds due



Figure 5. Pipelines of company Boie in Lübeck

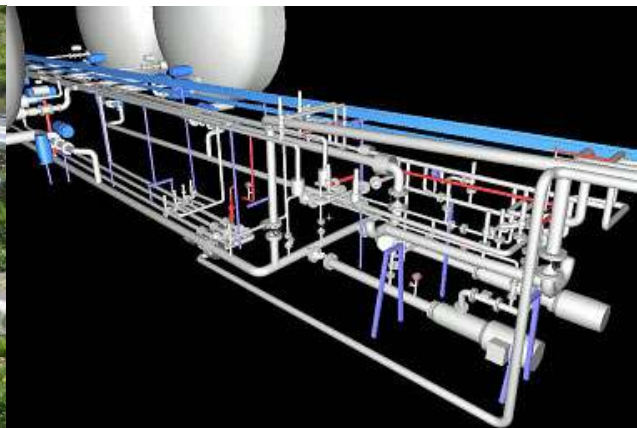

Figure 6. Same pipelines modelled in CAD.

to time limitations for the recording. The entire historical building could be recorded from 5 stations (Fig. 7) with 8 scans in 4 hours. The scanning resolution was in the range of 2 - 3cm. The measuring distances to the object were between 24m and 60m. In total 4 million points were scanned, which yielded a file size of 102 MB.

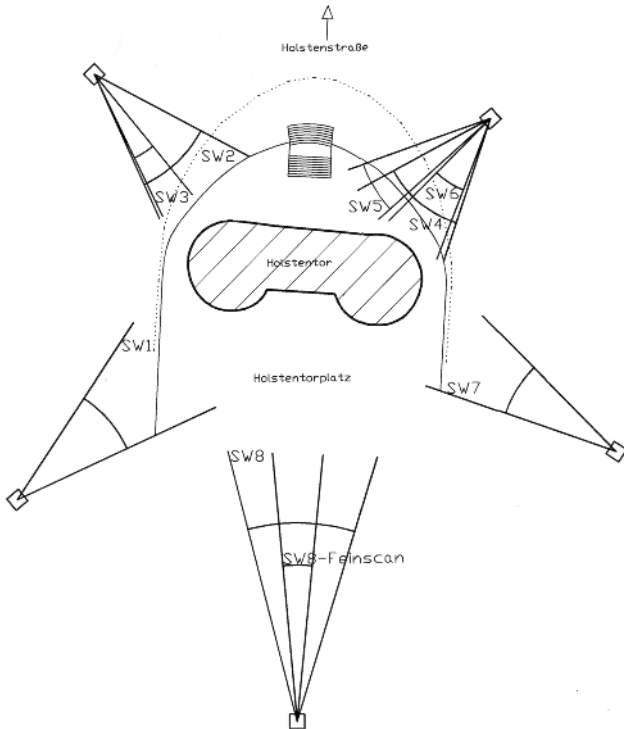

Figure 7. Laser scanner stations at the Holstentor in Lübeck

5.2 Data Processing

The registration of all point clouds (Fig. 8) was carried out exclusively using suitable overlap areas in each point cloud. Thereby a precision in the transformation of 8mm could be obtained.

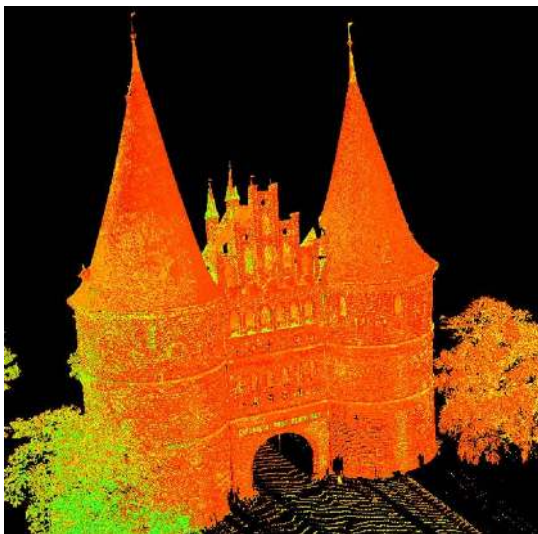

Figure 8. 3D point cloud in Cyclone.

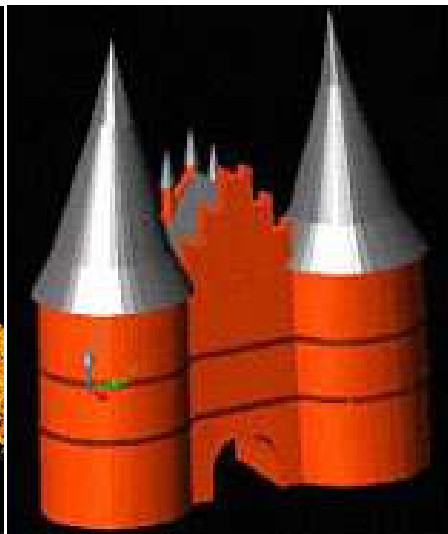

Figure 9. 3D model in AutoCAD



Figure 10. CAD 3D model of a window.

The second step of the processing was the generation of 2D facade maps. The point cloud could be processed with the plugin CloudWorx using arbitrary cuttings in AutoCAD. For the generation of the maps 2D polylines were drawn on the parallel projected part of the point cloud. As a result a view of the western front facade, a ground plan and a cutting at a map scale of 1:250 is illustrated in Fig. 11. A precision of 2cm could be derived for the 2D processing by comparing known distances to the point cloud. Here, the processing time needed for the generation of the 2D products took 17 hours in total.

In a further evaluation a rough 3D block model was generated manually from the point cloud in AutoCAD (Fig. 9). For this 3D model generation the focus was on the representation of the main characteristics of the Holstentor. Although deviations of up to 10cm to the point cloud were caused by the generalization in the modelling process, the 3D model of the Holstentor should be recognized in general. Such a reduced and texture mapped 3D model could be used for visualization in the Internet or in vehicle navigation systems. For the presentation of the data a virtual flight can be generated from the point cloud within a short time period. The bitmap textures that were generated in Cyclone along a virtual camera path were merged to an AVI file with a file size of 159MB and a sequence of 13 seconds. Due to suitable compression techniques a MPEG video with a file size of 3MB could be generated.

As an example it could be shown using a window (Fig. 10) of the Holstentor, that a detail construction from the point cloud is generally possible, if a point cloud with a sufficient density is available. In comparison to reference distances the accuracy was 2cm in the 3D CAD model. After additional manual operating it is feasible to bind single details to a total model in AutoCAD.

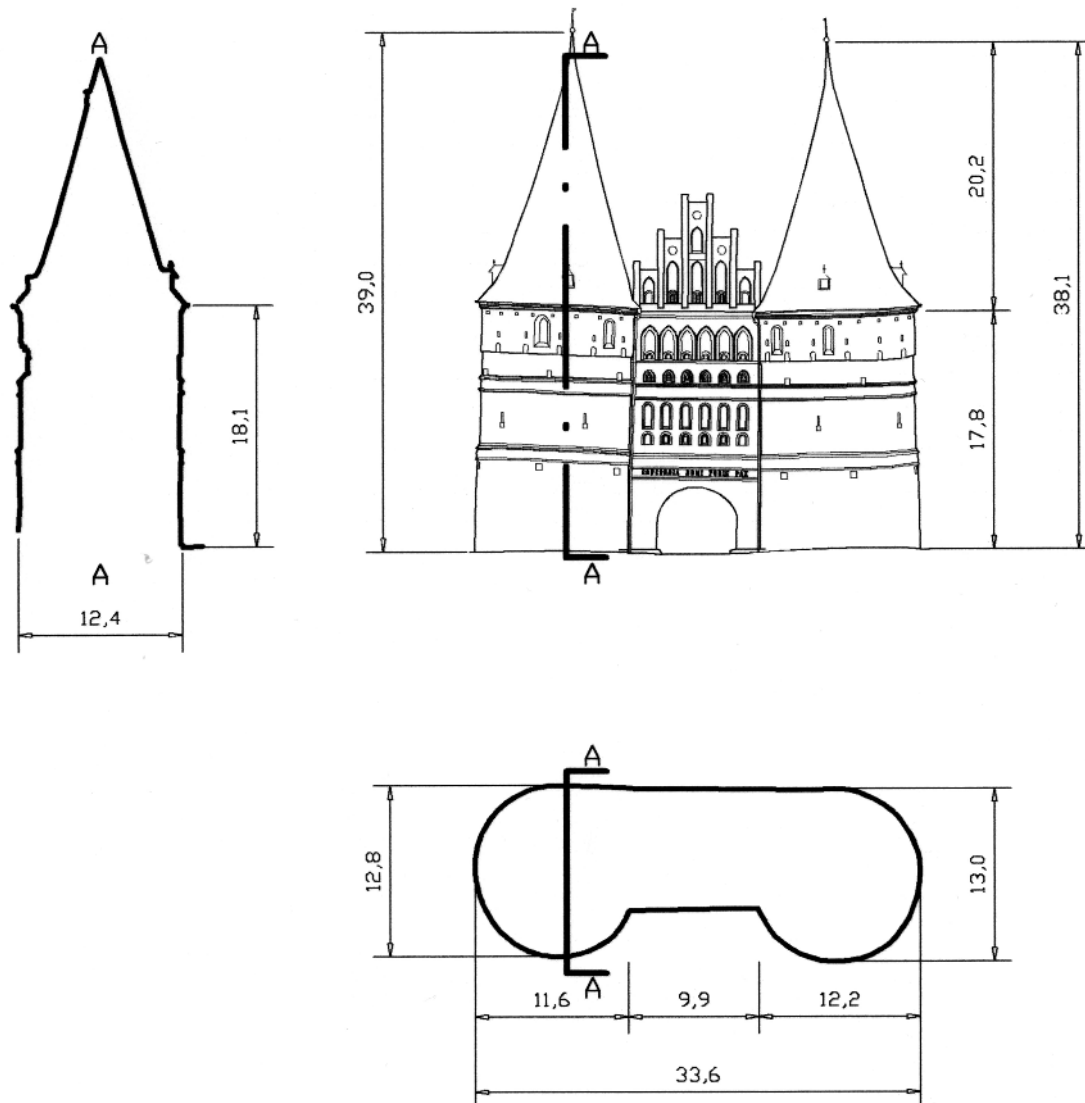

Figure 11. Results of the 2D post processing: section, view and ground plane of the Holstentor in Lübeck

6. ECONOMICAL ASPECTS

Although it is fascinating to look at the projects from the technical and realisation point a view, it is absolutely necessary to check the projects from an economic perspective. All processing steps could be accomplished with a standard PC (256 MB RAM, 1.4 GHz AMD Athlon processor). In Fig. 12 the total processing time needed for each individual processing step for each project is represented. In summary a ratio of 1:9 for data acquisition to data post processing could be achieved for both projects. If more post processing is necessary due to more requested details in the 3D model the ratio would increase. It could be clearly seen in Fig. 12 that scanning needs only approx. 20% of the project time, whereas the remaining 80% is used by registration and geo-referencing of the point clouds and by intensive post processing for the generation of the requested products. Thus, the measuring system permits the fast and comprehensive production of object-related measuring data. Furthermore, the scanned object can be virtually taken to the office in form of point clouds. Usually, details are rarely forgotten during the data acquisition due to the automated high resolution scanning of the objects.

7. RESULT AND OUTLOOK

In conclusion, in two different projects it was demonstrated, that the tested terrestrial laser scanning system is suitable for detailed 3D data acquisition and object modelling. The 3D laser scanning system Cyrax 2500 has been proven to be stable and simple to use. The level of detail, which can be set by the scan grid during the data acquisition phase, depends on the requirements of each application. The precision of the processed data is 1cm in Cyclone and 2cm in AutoCAD. This achieved precision could fulfil the requirements of the presented applications. Due to its measuring accuracy, its high point density, and its measurement speed laser scanning increasingly represents an alternative to and/or an additional option for geodetic and photogrammetric data acquisition methods. In particular, the use of the Cyrax 2500 for the recording of outdoor applications can be recommended although the camera-view scanner has a restricted field of view. In contrast to the outdoor use of the scanner, it would not be very efficient to use the CYRAX scanner for indoor applications because of the narrow field of view.

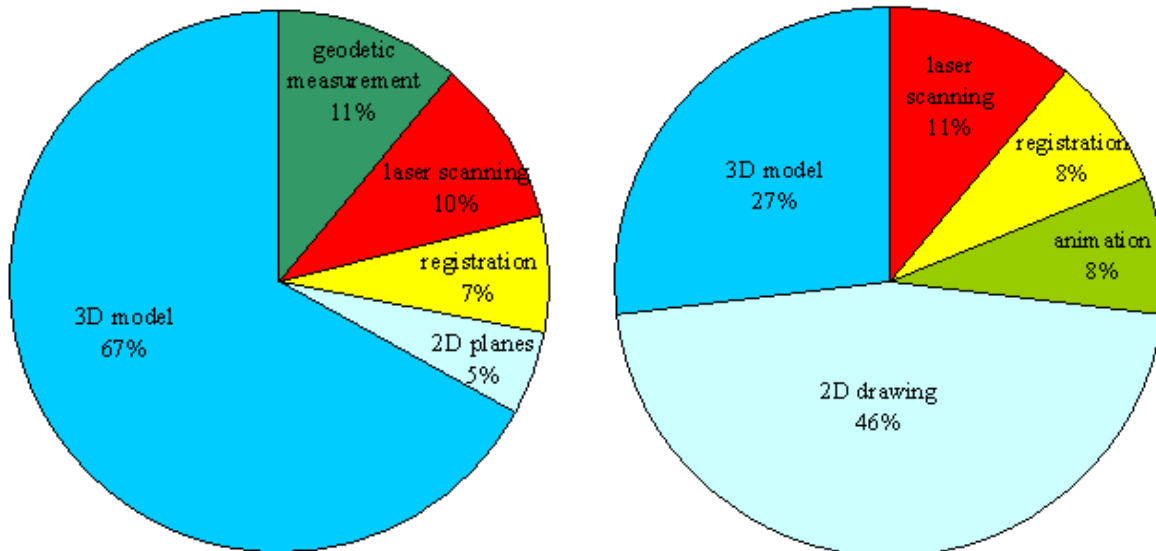

Figure 12. Estimated time needed to complete the Boie pipeline project (left) and the Holstentor project (right)

In the future increased automation in data post processing will be necessary to achieve increased acceptance of this technology in the market. This will consequently lead to the use of laser scanning systems as efficient workhorses in surveying and geomatics. One can expect that laser scanning systems will be developed into multi sensor systems with a digital camera for the combination of point clouds and high resolution images and a GPS/INS for positioning and/or automatic geo-referencing of the point clouds. The combination with geodetic measuring procedures was already concerned with the further development of the Cyrax 2500, the HDS 3000. In the future the systems will become faster, more precise, more convenient and, hopefully, also less expensive. Possible collaborations/co-operations between universities, industry and system manufacturers will contribute to the improvement of and the market acceptance of the laser scanning systems in the future.

8. REFERENCES

- Boehler, W., Bordas Vicent, M., Marbs, A., 2003. Investigating Laser Scanner Accuracy. Proceedings of XIXth CIPA Symposium, Antalya, Turkey, Sep. 30 – Oct. 4.
- Cyra, 2003a. Cyra Technologies Inc. <http://www.cyra.com/> (visited 10 July 2003)
- Cyra, 2003b. *Cyclone 4.0 and Cyrax Basic Training Course – Session I*. Cyra Technologies Inc., European Office, Rijswijk, The Netherlands
- Grün, A., Kahmen, H., 2001. *Optical 3-D Measurement Techniques V*. Wichmann Verlag, Heidelberg.
- Grün, A., Kahmen, H., 2003. *Optical 3-D Measurement Techniques VI*. Wichmann Verlag, Heidelberg.
- Jahn, I. (2003): *Das CYRAX® 3D-Laserscanning-System – Untersuchungen bei der Erfassung einer Industrieanlage der Firma Boie und des Lübecker Holstentores*. Unpublished diploma thesis, Department of Geomatics, HAW Hamburg, September
- Johansson, M., 2003. *Explorations into the behaviour of three different high-resolution ground-based laser scanners in the built environment*.
- Proceedings of the CIPA WG 6 International Workshop on Scanning for cultural heritage recording, Corfu, Greece, <http://www.isprs.org/commission5/workshop>.
- Kersten, Th., Sternberg, H., Mechelke, K., Acevedo Pardo, C., 2004. *Terrestrial laser scanning system Mensi GS100/GS200 - Accuracy tests, experiences and projects at the Hamburg University of Applied Sciences*. IAPRS, Vol. XXXIV, PART 5/W16, Editors H.-G. Maas & D. Schneider, Proceedings of the ISPRS working group V/1 'Panoramic Photogrammetry Workshop', Dresden, Germany, February 19-22, 2004, <http://www.tu-dresden.de/fghgipf/photo/PanoramicPhotogrammetry-Workshop2004/Proceedings.htm>
- Lichti, D.D., Gordon, S.J., Stewart, M.P., Franke, J., Taskiri, M., 2003. *Comparison of digital photogrammetry and laser scanning*. Proceedings of the CIPA WG 6 International Workshop on Scanning for cultural heritage recording, Corfu, Greece, <http://www.isprs.org/commission5/workshop>.
- Luhmann, T., 2002. *Photogrammetrie und Laserscanning – Anwendungen für As-Built-Dokumentation und Facility Management*. Wichmann Verlag, Heidelberg
- Luhmann, T. (2003): *Photogrammetrie, Laserscanning, Optische 3D-Messtechnik – Beiträge der Oldenburger 3D-Tage 2003*. Wichmann Verlag, Heidelberg
- Luhmann, T., 2004. *Photogrammetrie, Laserscanning, Optische 3D-Messtechnik – Beiträge der 3. Oldenburger 3D-Tage 2004*. Wichmann Verlag, Heidelberg, in print.
- Schadendorf, W. (1977): *Das Holstentor*. P. Martin (Ed.), Verlag der Buchhandlung Gustav Weiland, Lübeck