



TESTING OF SPECIAL LYS STEEL PLATE SHEAR WALLS

Darren VIAN¹ and Michel BRUNEAU²

SUMMARY

An experimental program of steel panel shear walls is outlined and some results are presented. The tested specimens utilized low yield strength (LYS) steel infill panels and reduced beam sections (RBS) at the beam-ends. Two specimens make allowances for penetration of the panel by utilities, which would exist in a retrofit situation. The first, consisting of multiple holes, or perforations, in the steel panel, also has the characteristic of further reducing the corresponding solid panel strength (as compared with the use of traditional steel). The second such specimen utilizes quarter-circle cutouts in the panel corners, which are reinforced to transfer the panel forces to the adjacent framing.

INTRODUCTION

The selection of Steel Plate Shear Walls (SPSWs) as the primary lateral force resisting system in buildings has increased in recent years as design engineers discover the benefits of this option. Its use has matured since initial designs, which did not allow for utilization of the post-buckling strength, but only elastic and shear yield plate behavior. This design approach typically resulted in the selection of a relatively thick panel for the infill. A large plate thickness, while producing a stiff structure that would reduce displacement demand during a seismic event, would also induce relatively large forces on the surrounding frame members, which must be detailed accordingly to ensure adequate performance.

Research conducted by Thorburn et al. [1] supported the SPSW design philosophy that reduced plate thickness by allowing the occurrence of shear buckling. After buckling, lateral load is carried in the panel via the subsequently developed diagonal tension field action. Smaller panel thicknesses also reduce forces on adjacent members, resulting in more efficient framing designs. Research programs at various universities have furthered the understanding of thin plate SPSWs (e.g. Lubell et al [2], Driver et al [3], Caccese et al [4]).

However, some obstacles still exist that may impede further widespread acceptance of this system. For example, using the yield stress for typically available steel material, the panel thickness as required by a given design situation may often be much thinner than plate typically available from steel mills. In a case such as this, using the minimum available plate thickness would result in a large difference in panel forces

¹ Ph.D. Candidate, Department of Civil, Structural, and Environmental Engineering, University at Buffalo, Buffalo, NY, USA. Email: vian@eng.buffalo.edu

² Professor, Department of Civil, Structural, and Environmental Engineering, University at Buffalo, Buffalo, NY, USA. Email: bruneau@mceermail.buffalo.edu

from that required by calculations. Attempts at alleviating this problem were recently addressed by the use of light-gauge, cold-formed steel panels, in a new application by Berman and Bruneau [5]. Xue and Lu [6] suggested additional means of reducing demand on framing adjacent to an SPSW, including the connection of the infill panel to only the beams in a moment frame. However, more work is required to ensure the viability of the SPSW system in a wide range of situations.

The University at Buffalo (UB) and the Multidisciplinary Center for Earthquake Engineering Research (MCEER) initiated a co-operative experimental program with National Taiwan University (NTU) and the National Center for Research on Earthquake Engineering (NCREE) in order to further address the above issues with regards to SPSW performance. A description of the test program and presentation of results follows below.

EXPERIMENTAL PROGRAM

A total of three single bay, single story LYS SPSW specimens were designed by the researchers at UB, fabricated in Taiwan, and subjected to quasi-static cyclic testing in the NCREE laboratory at NTU. The frames measured 4000mm wide and 2000mm high between member centerlines, and consisted of 345MPa steel members. The infill panels produced by China Steel were 2.6mm thick, LYS steel plates with an initial yield stress of 165MPa, and ultimate strength of 300MPa, important properties that may aid in alleviating over-strength concerns mentioned above. All specimens also have a beam-to-column connection detail that includes reduced beam sections (RBS) at each end. This detail was designed to ensure all inelastic beam action would occur at these locations, with the intention of efficient anchoring of infill panel tension field forces, as required at the extremes (roof and basement level beams) of a multistory SPSW-retrofitted/designed steel frame. A solid panel specimen is shown schematically in Fig. 1.

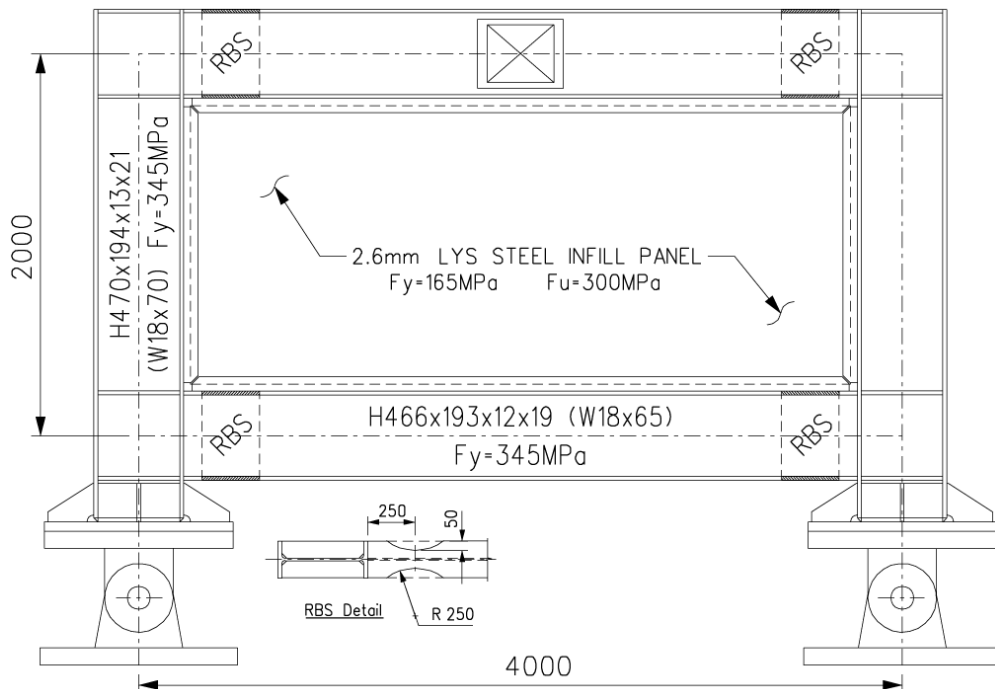

Figure 1: Typical specimen dimensions

Two specimens tested had solid panels while the remaining two provide utility access through the panels using cutouts. One specimen consisted of a panel with a total of twenty 200mm-diameter holes, or perforations, in an arrangement shown in Fig. 2. Roberts and Sabouri-Ghomi [7] conducted research

investigating the effects of a single perforation in an unstiffened shear panel, leading to some reduction factors that could be applied to the properties of a solid panel, conservatively reducing the stiffness and strength to account for the presence of the perforation. The multiple perforations present in the tested specimen share the common goal of utility access in order to make the SPSW system more acceptable, while also serving as a method of reducing the panel strength and therefore the demand on the surrounding framing. This latter characteristic may prove beneficial in markets that do not have LYS readily available for structural applications.



Figure 2: Specimen P before testing

The other specimen allowing for utility penetration is a solid panel, with the top corners of the panel cutout and reinforced to transmit panel forces to the surrounding framing, as shown in Fig. 3 below. This specimen would allow utility access through the wall, while also transmitting forces near that of the solid panel counterpart.



Figure 3: Specimen CR before testing

All specimens were tested using a cyclic, quasi-static loading protocol similar to ATC-24. In agreement with the typical testing procedure at NCREE, a displacement-controlled scheme was selected for the entire experimental program. Based on estimates of yield from SAP2000 pushover analyses, the displacement history shown in Fig. 4, was developed and applied horizontally to the center of the top beam using four actuators, as shown in the figures above. The same displacement loading history was used for actuator control of all the specimens tested.

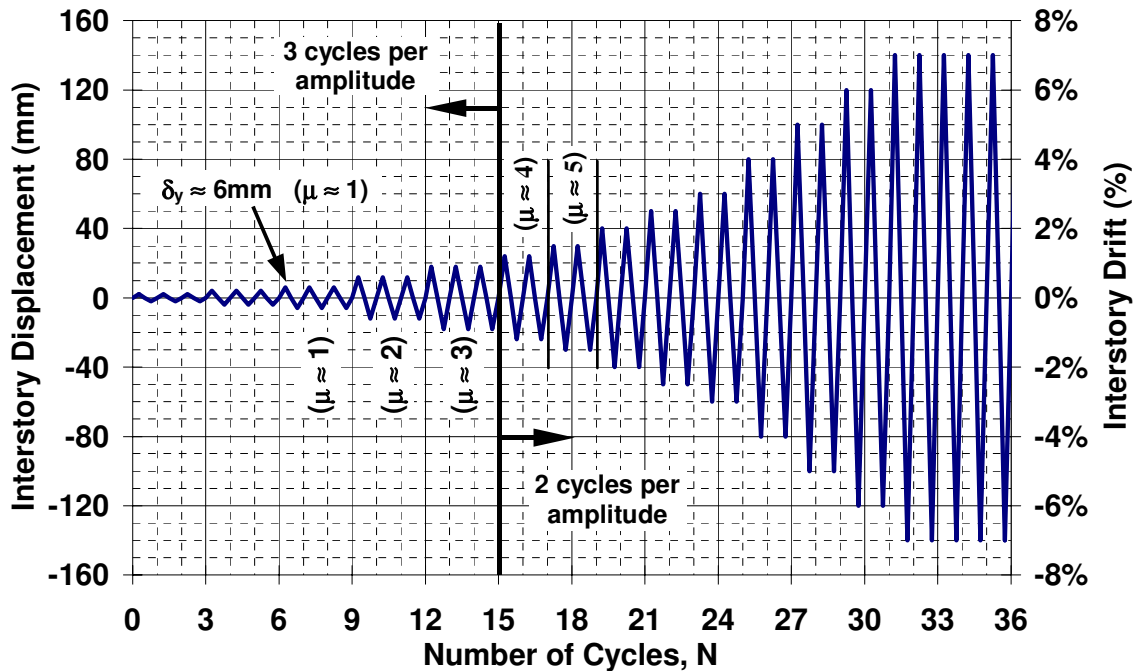

Figure 4: Displacement Loading History

EXPERIMENTAL RESULTS

The hysteresis of specimen P is shown in Fig. 5. Small fractures were found at panel corners at the conclusion of the test. Panel welds splicing together the three pieces remained intact for the entire test. An instability with the loading scheme led to the H-shaped loading detail twisting at the center of the top beam. Two attempts were made to correct the problem, and though a visual inspection revealed no visible residual effect due to the H rotation, damage to the specimen incurred in the initial incident was too much for the specimen to handle at larger displacements. Columns rotated about their vertical axis with increasing severity as the test continued. The test was concluded after reaching a drift of 3%, when a weld failed in the continuity plate at the top of a column, and the other damage and distortions of the specimen made it impractical to continue.

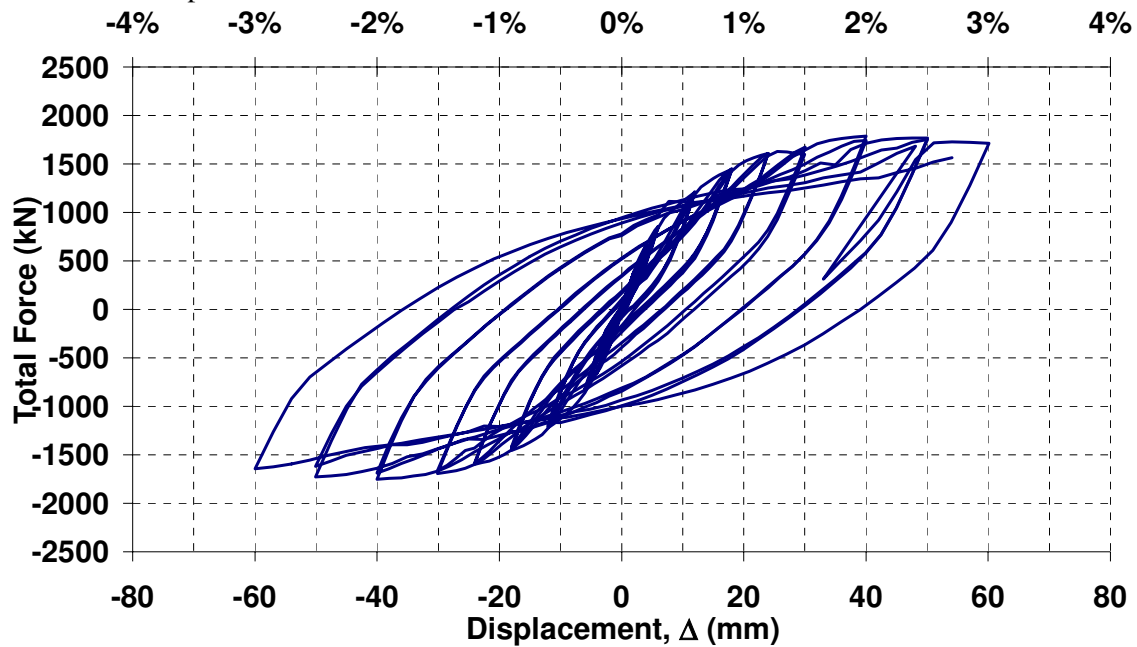

Figure 5: Specimen P Hysteresis

Photos of the buckled panel following the test, and a yielded RBS connection at 2.5% drift, are shown in Figs. 6 and 7, respectively. Fig. 6 also shows one of the methods used to reduce the rotation of the loading detail: two beams, placed parallel to the wall on both sides, which are then tied down into the strong floor using post-tensioning bars. Roller bearings between these beams and the loading detail reduced the horizontal friction, making this a fairly effective solution.

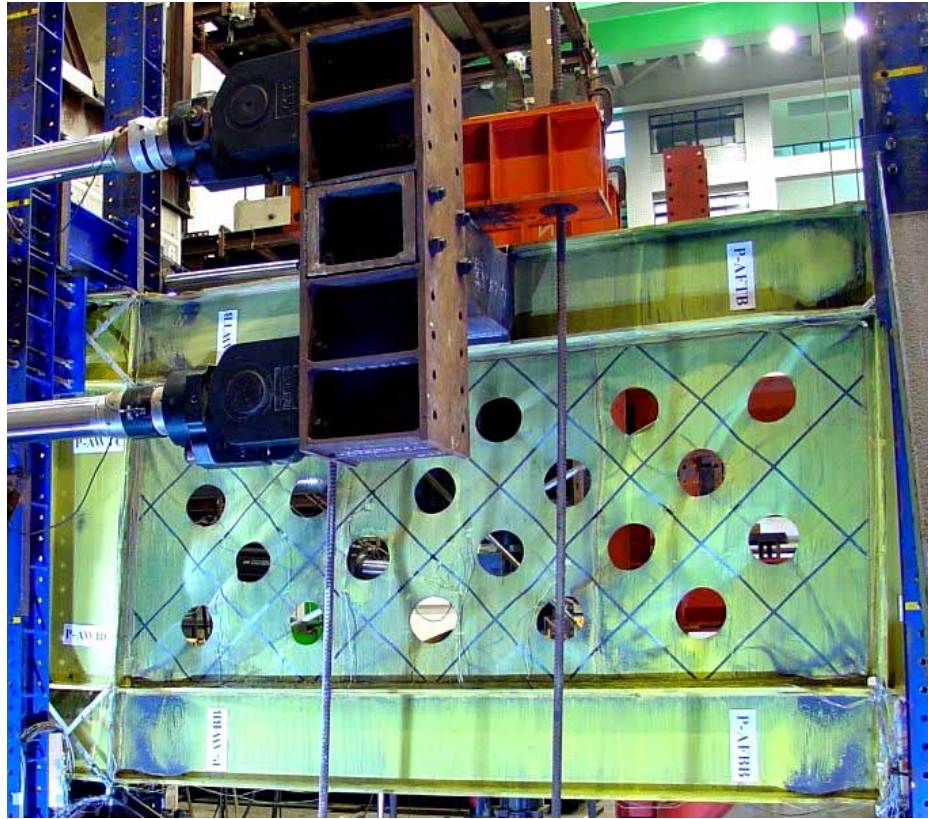

Figure 6: Damage to panel and boundary frame (Specimen P: End-of-test, $\gamma = 3.0\% \approx 10\delta_y$)



Figure 7: Yielding of bottom beam RBS (Specimen P: Cycle 23, $\gamma = 2.5\% \approx 8.333\delta_y$)

The specimen CR hysteresis is shown in Fig. 8 below, exhibiting stable behavior to relatively modest drifts. However, the problems in the loading scheme observed in other tests were also experienced in this test. The loading detail twisted the top beam (though not as severely, due to careful monitoring and prevention), and the columns twisted, severely distorting the top beam by the end of the testing. Web local buckling occurred in the bottom beam RBS connections after 1.5% drift, but the global behavior was not adversely affected until fracture and rupture of the bottom flange of the bottom beam in the RBS

connections after cycling at 2.5% drift. Panel and bottom beam RBS connection yielding at 1.5% drift is shown in Fig. 9.

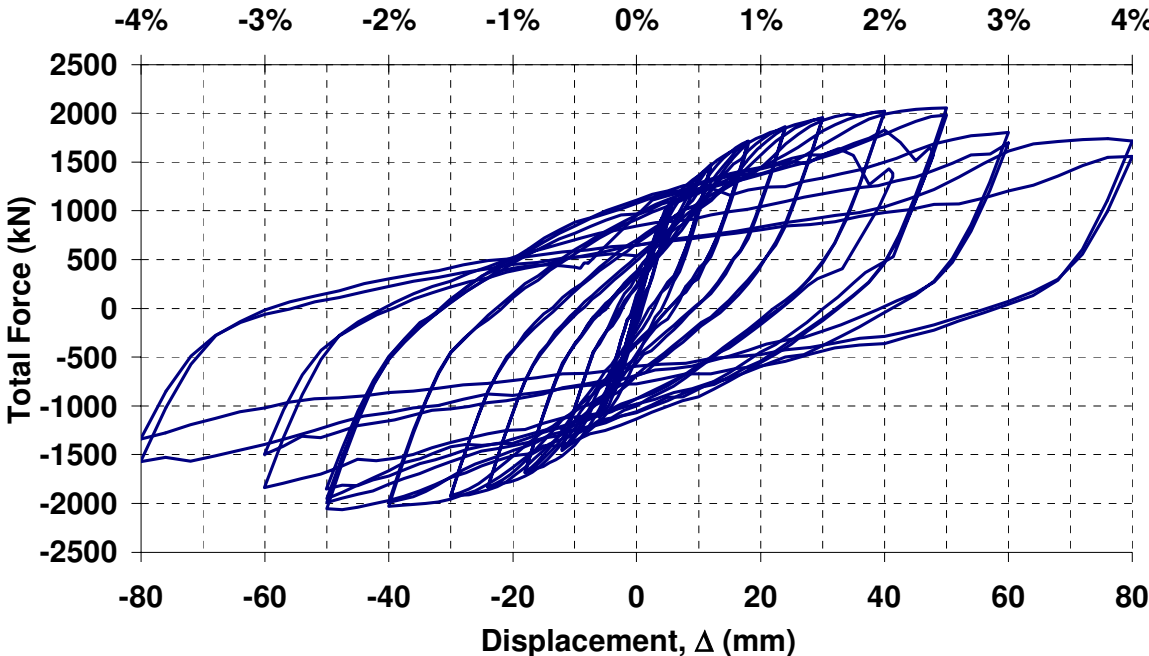

Figure 8: Specimen CR Hysteresis



Figure 9: Infill panel and RBS yielding (Specimen CR: Cycle 19, $\gamma = 1.5\% \approx 5\delta_y$)

Solid panel specimen S2, like the others tested in this program, exhibited desirable hysteretic behavior, as shown in Fig. 10 below. However, the specimen also experienced the same issues with the loading scheme, resulting in the twisting of columns and damaging the top beam, ultimately to a point at which further testing of the specimen became impractical. Testing was ceased following the strength drops during cycles at 3% drift, due to rupture of the bottom flange in each bottom beam RBS connection.

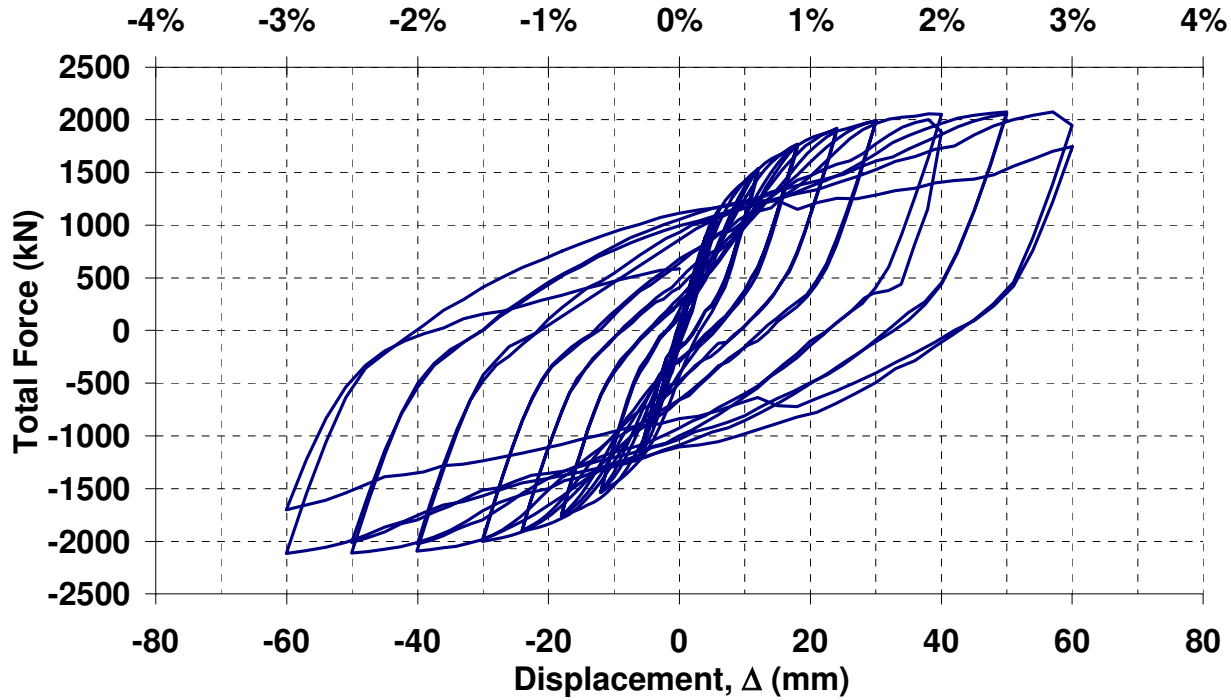

Figure 10: Specimen S2 Hysteresis

DISCUSSION OF TEST RESULTS

All specimens tested in this experimental program exhibited stable force-displacement behavior, with very little pinching of hysteresis loops until the significant accumulation of damage at large drifts.

The pushover analysis used in developing the loading history proved to have very good agreement with the test results. Fig. 11 shows the SAP backbone curve versus the force versus top displacement hysteresis for solid panel specimen S2. The frame was modeled using 2D beam elements with elastic-perfectly plastic (EPP) hinges, with an assumed overstrength of 10% for the nominal yield stress of the frame member material. Elastic stiffness and initial yield are both estimated well, although ultimate specimen strength was underestimated, as the EPP material used in modeling the frame did not accounting for strain hardening.

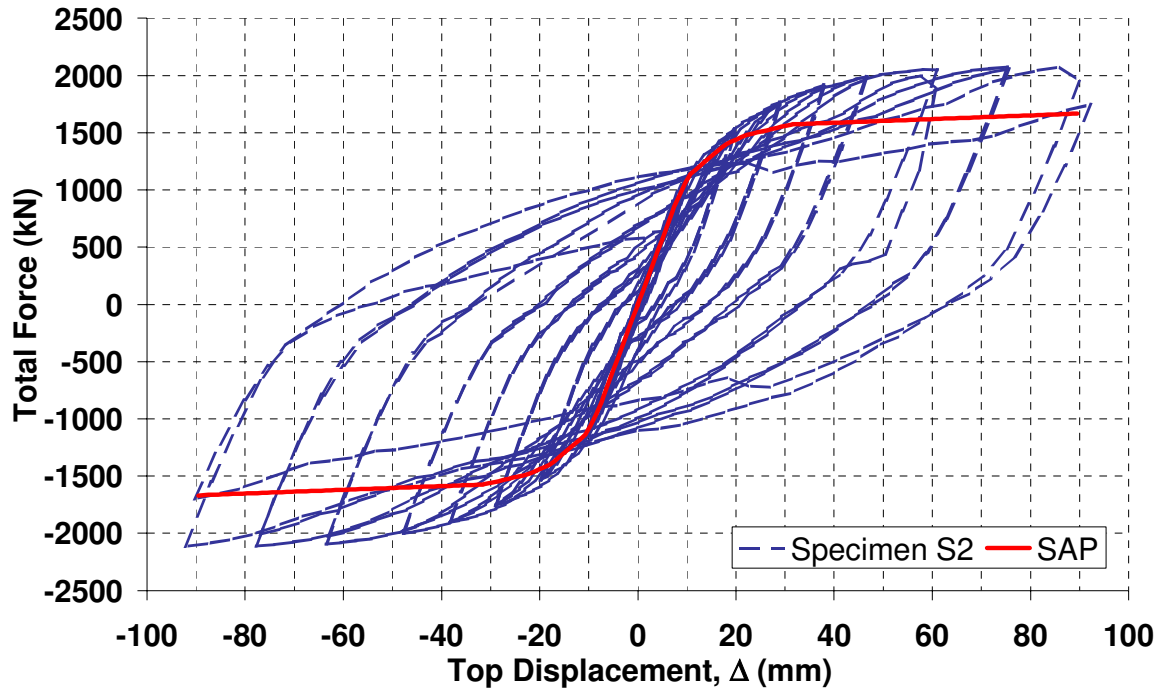

Figure 11: Specimen S2 Hysteresis with SAP Pushover backbone curve

Specimen P performed well at the beginning of the test, behaving elastically at small displacements and exhibiting stable hysteretic behavior in the inelastic range. The stiffness and strength were both reduced, as anticipated, from the solid panel specimen values. Yielding in the panel spread between the perforations, remaining mainly in the narrow region between the holes. From a qualitative standpoint, the perforations reduced the audible sound produced by buckling of the panel, as the specimen was cyclically loaded. This would be beneficial in a building application, towards the negative perceptions of building occupants.

Specimen CR performed well, exhibiting stable hysteretic behavior until a drift of 2.5%, during which cycles, fractures, followed by ruptures occurred in the bottom flange of each bottom beam RBS connection. These events significantly changed the load path in the specimen, resulting in the 20% drop in strength by the termination of loading after two cycles at 4% drift.

CONCLUSIONS

Steel plate shear walls of low yield strength steel appear to be a viable option for use in resistance of lateral loads imparted on a structure during seismic excitation. The lower yield strength and thickness of the tested panels resulted in a reduced stiffness and earlier onset of energy dissipation by the panel as compared to currently available hot-rolled plate.

The perforated panel specimen shows promise towards alleviating stiffness and over-strength concerns using conventional hot-rolled plates, useful for markets in which LYS steel is not readily available. This option can also provide access for utilities to penetrate the system, important in a retrofit situation, where building use is pre-determined before SPSW implementation.

The cutout reinforced corner specimen appears to be a design option that will allow a designer the option of sizing for a solid panel infill, but still have the benefit of access through the wall for utilities.

The reduced beam section details in the beams performed as designed. Use of this detail may result in more economical designs for beams “anchoring” an SPSW system at the top and bottom of a multi-story frame. However, further investigation of past research is needed to clarify design issues relevant to addition to an SPSW frame.

ACKNOWLEDGEMENTS

The valuable contributions of Dr. Keh-Chyuan Tsai and Mr. Ying-Cheng Lin of NCREE/NTU to this project are sincerely appreciated.

This work was financially supported in part by the Earthquake Engineering Research Centers Program of the National Science Foundation under Award No. ECC-9701471 to the Multidisciplinary Center for Earthquake Engineering Research, and in part by the National Science Council and the National Center for Research on Earthquake Engineering. Both sponsors are gratefully acknowledged. The writers are also grateful to China Steel, who provided the LYS panels for the specimens, and to the technical support at NCREE. Any opinions, findings, conclusions, and recommendations presented in this paper are those of the writers and do not necessarily reflect the views of the sponsors.

REFERENCES

1. Thorburn LJ, Kulak GL, Montgomery CJ. “Analysis of Steel Plate Shear Walls.” Structural Engineering Report No. 107, Department of Civil Engineering, The University of Alberta, Edmonton, Alberta, May 1983.
2. Lubell A, Prion H, Ventura C, Rezai M. “Unstiffened Steel Plate Shear Wall Performance Under Cyclic Loading.” ASCE Journal of Structural Engineering 2000; 126(4): 453-460.
3. Driver RG, Kulak GL, Kennedy DJL, Elwi AE. “Seismic Behavior of Steel Plate Shear Walls.” Structural Engineering Report 215, University of Alberta, Department of Civil and Environmental Engineering, February 1997.
4. Caccese V, Elgaaly M, Du C. “Postbuckling Behavior of Steel-Plate Shear Walls under Cyclic Loads.” ASCE Journal of Structural Engineering 1993; 119(2): 588-605.
5. Berman JW, Bruneau M. “Experimental Investigation of Light-Gauge Steel Plate Shear Walls for the Seismic Retrofit of Buildings.” Technical Report MCEER-03-0001, Multidisciplinary Center for Earthquake Engineering Research, Buffalo, NY, May 2, 2003.
6. Xue M, Lu L. “Interaction of Infilled Steel Shear Wall Panels with Surrounding Frame Members.” Proceedings, 1994 Annual Task Group Technical Session, Structural Stability Research Council: reports on current research activities. Lehigh University, Bethlehem, PA, June 20, 1994.
7. Roberts T, Sabouri-Ghomi S. “Hysteretic characteristics of unstiffened perforated steel plate shear panels”, Thin Walled Structures 1992; Vol. 14: 139-151.