

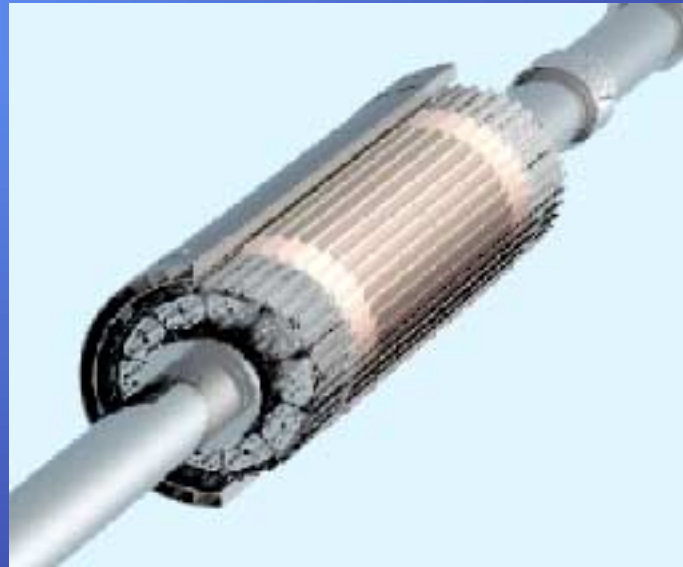

# The Alice Silicon Pixel Detector (SPD)



**Peter Chochula**  
for the  
**Alice Pixel Collaboration**



# The Alice Pixel Detector

Alice event: 0, Run:0  
Nparticles = 3075 Nhits = 121491

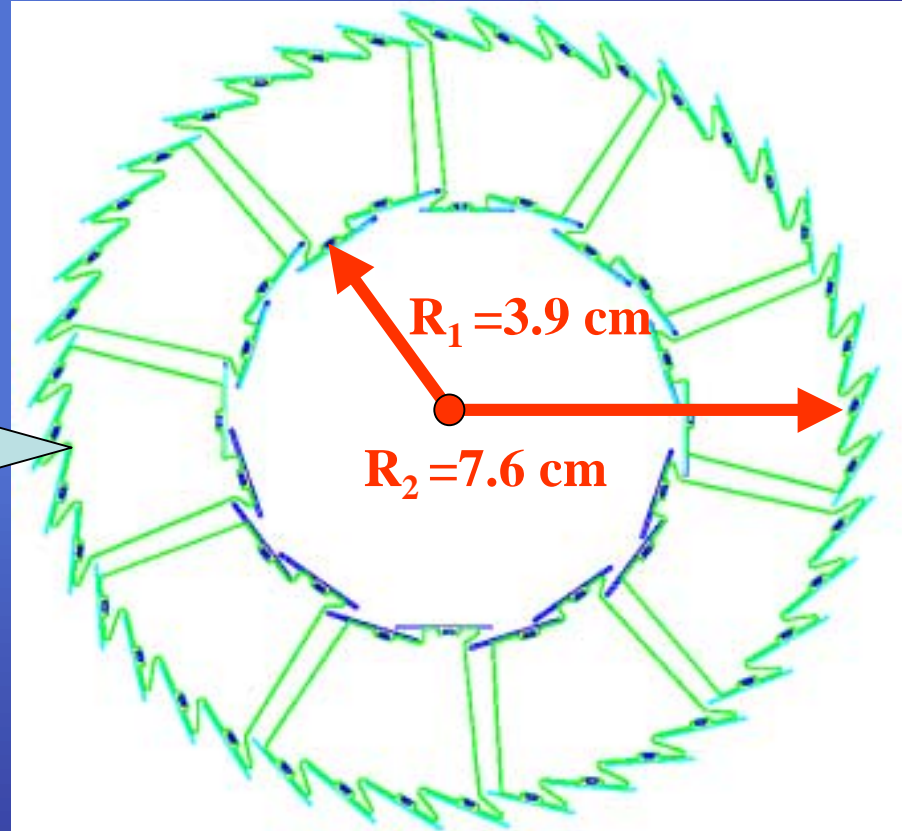
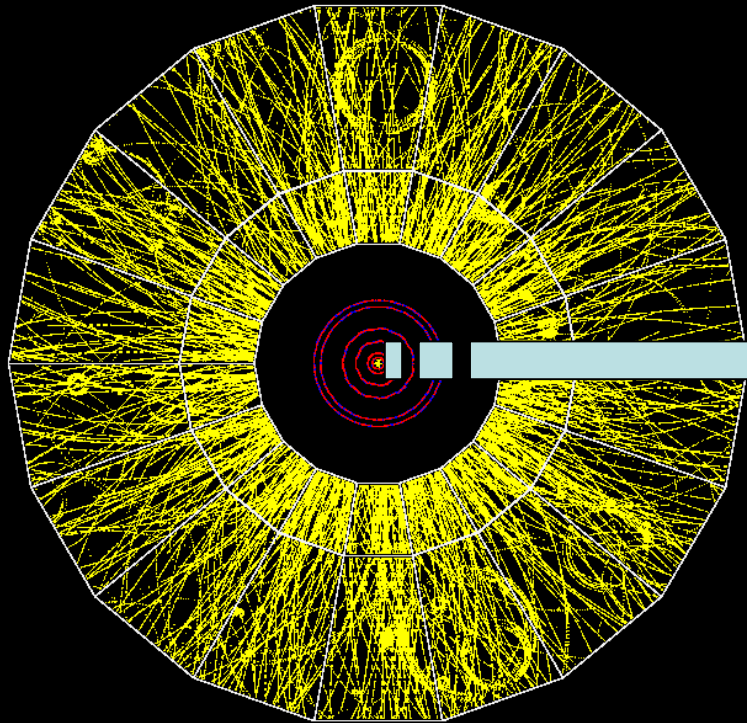

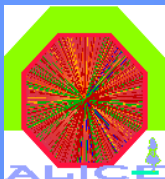

# Main Physics Goal – Heavy Flavour Physics

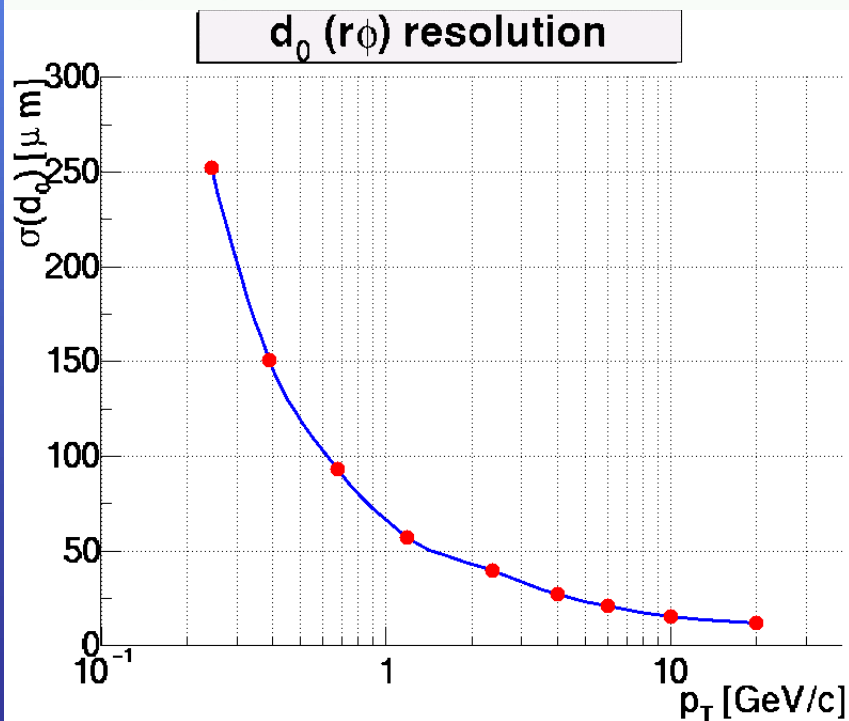
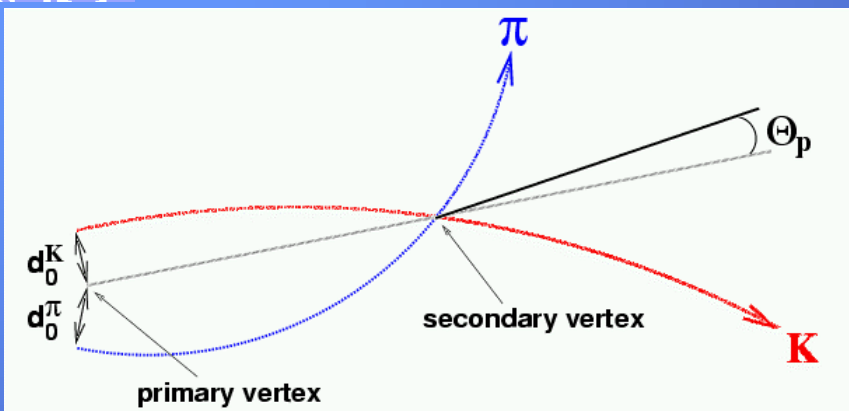

$D^0 \rightarrow K^- \pi^+$  15 days Pb-Pb data taking  
Significance  $(S/\sqrt{B}) = 35$

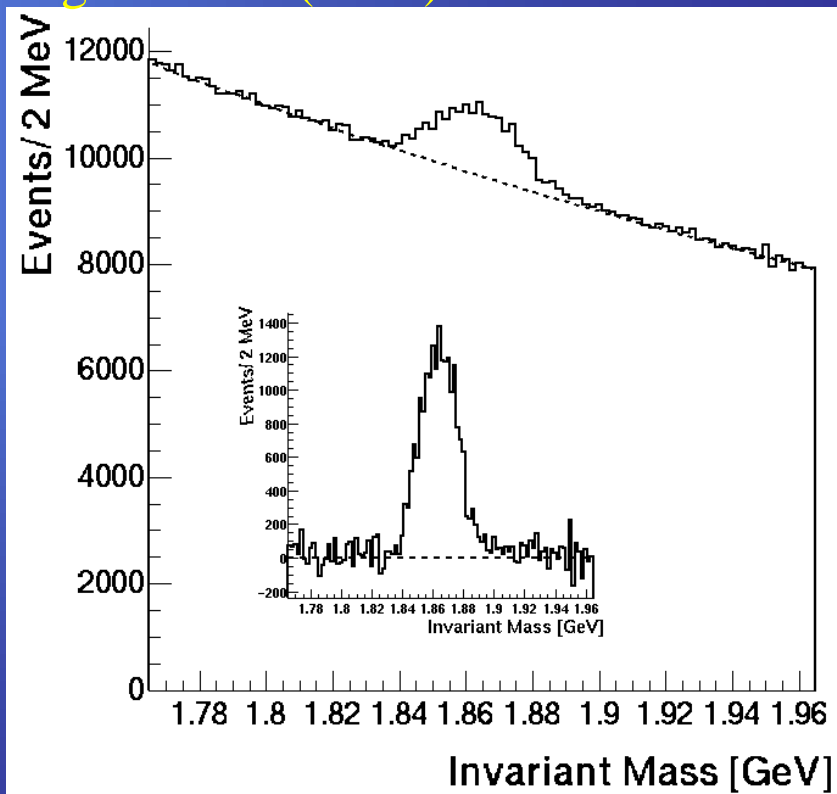

See poster PE 155 by Andrea Dianese

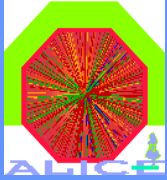

# Main Features of the Readout Chip

- **0.25 $\mu$ m CMOS technology**
- **Radiation-tolerant layout**
- **Mixed analog and digital chip**
- **Low noise : 110 electrons rms**
- **Low threshold: 1000 electrons rms**
- **Power consumption: ~900mW/chip**

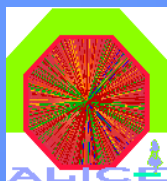

# The Alice1 Pixel Cell

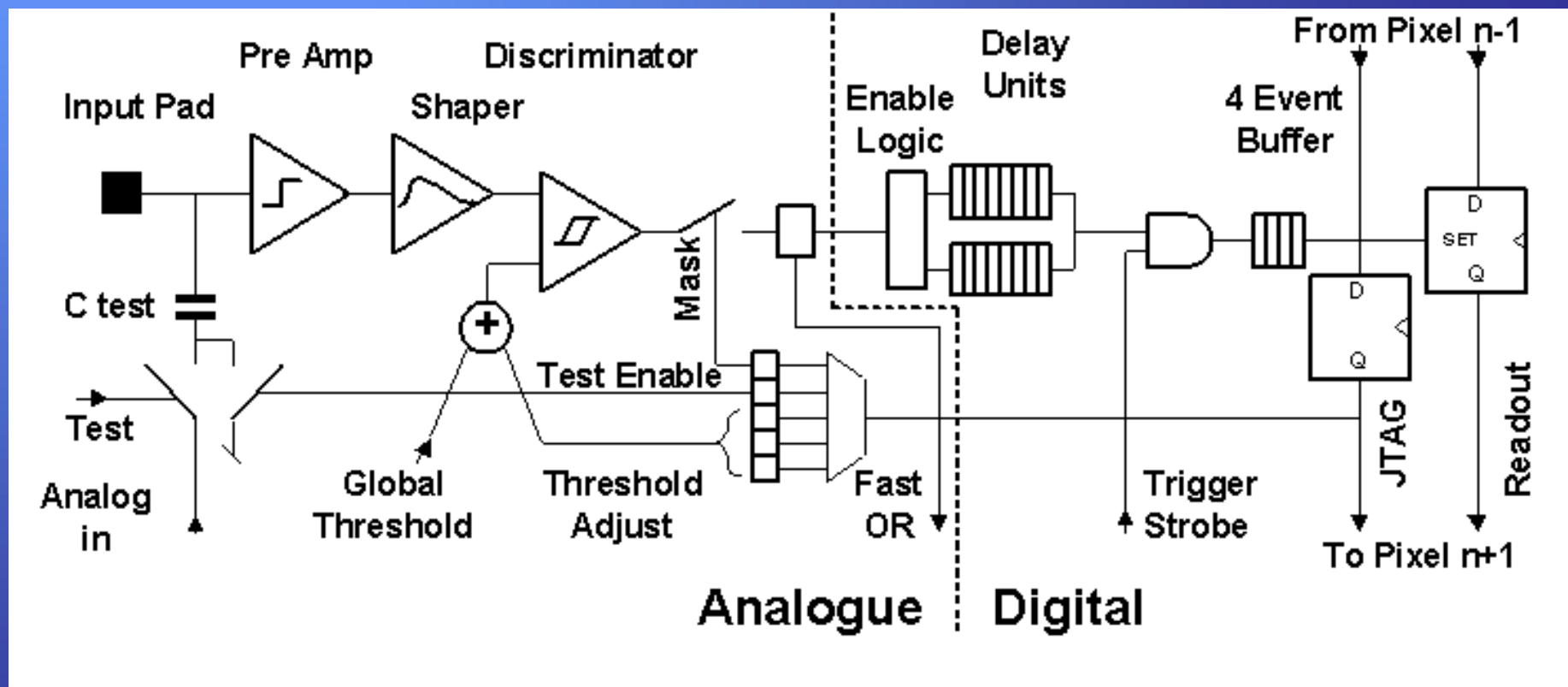



# The Alice1 Chip Layout

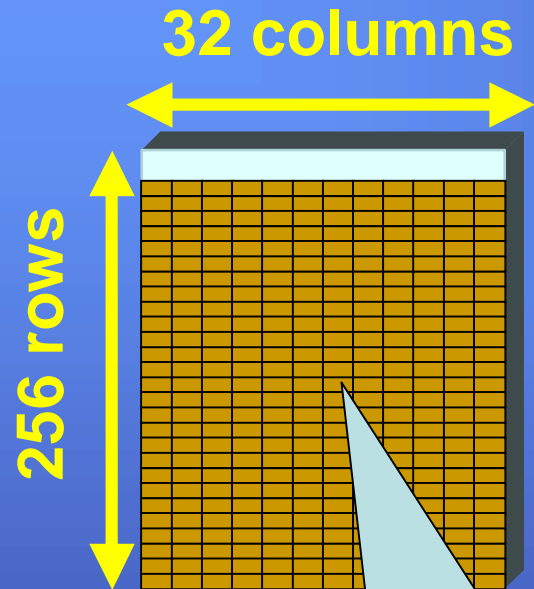

8 192 pixels/chip

~13 000 000 transistors/chip

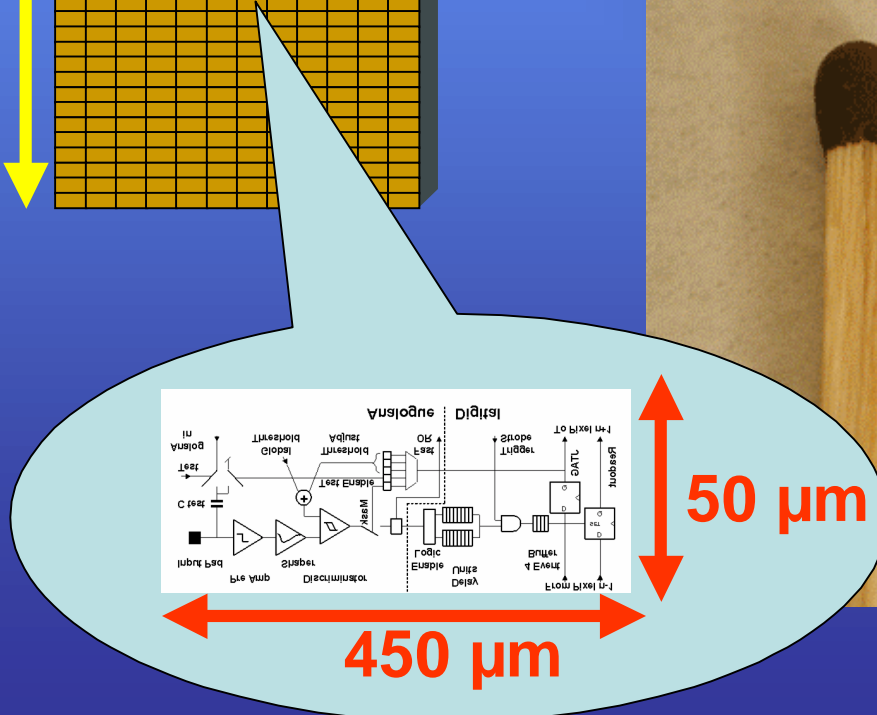
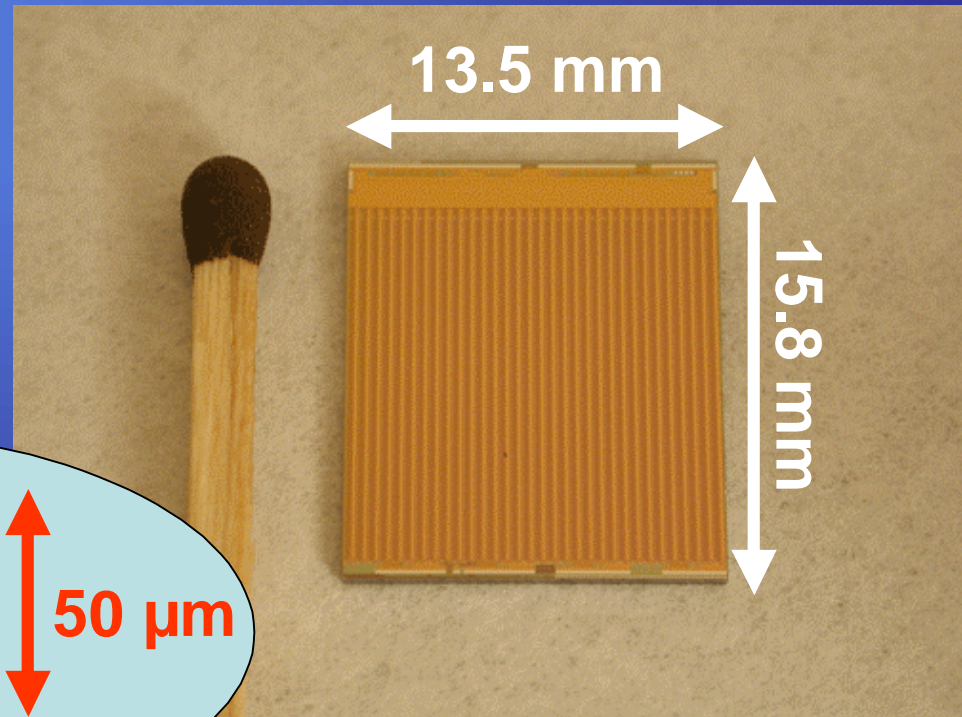



# SPD Components

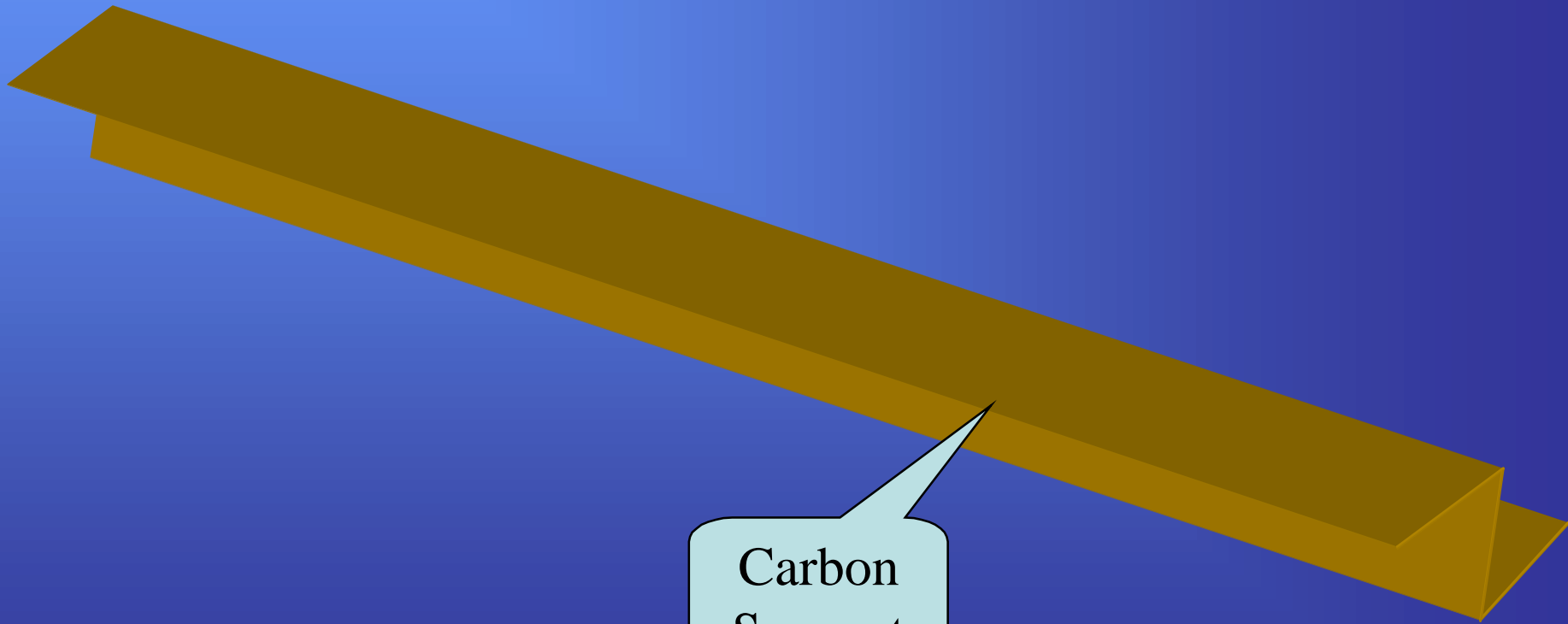

Carbon  
Support

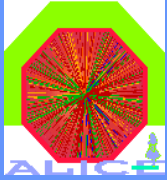

# SPD Components

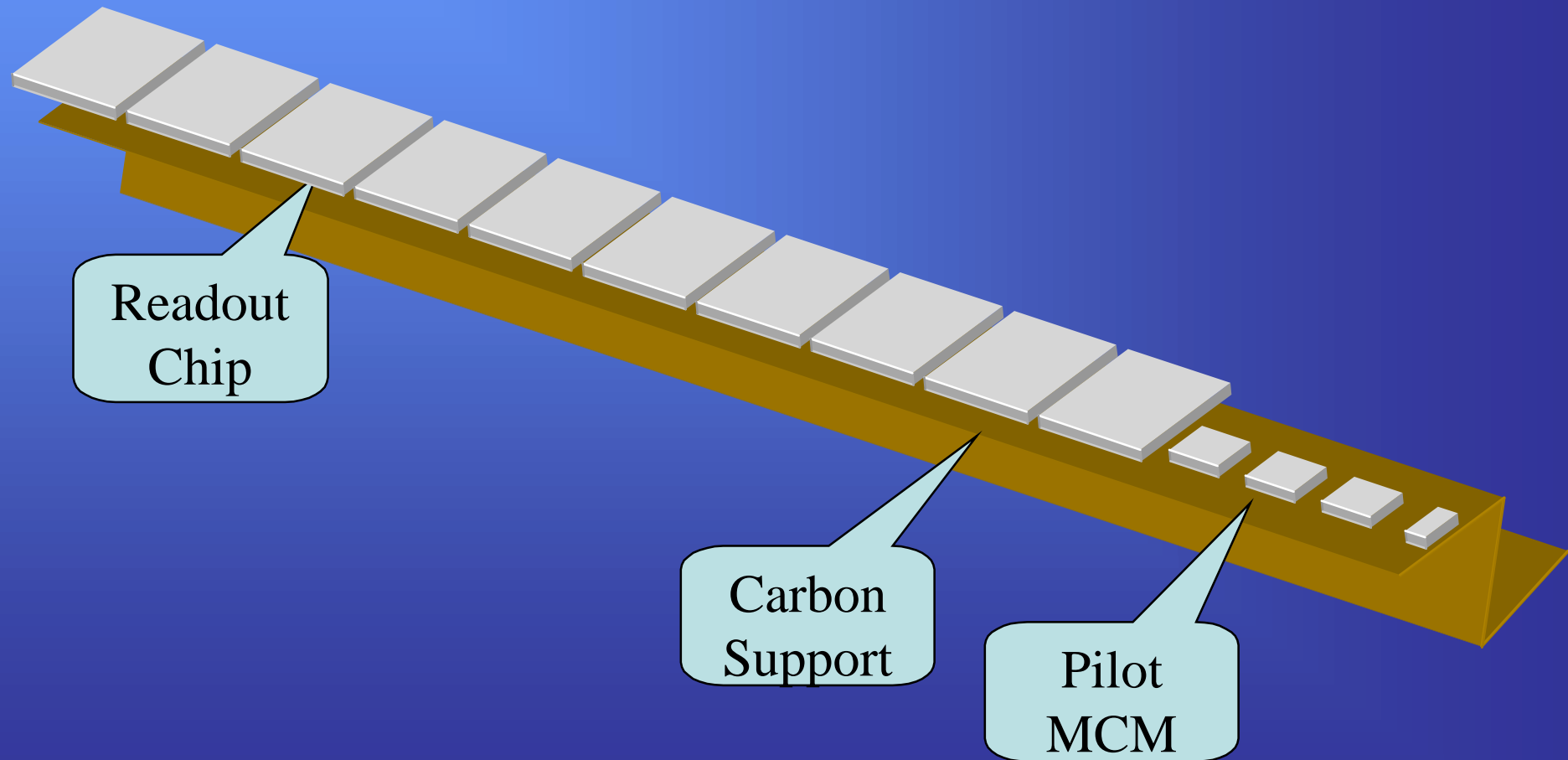





# SPD Components

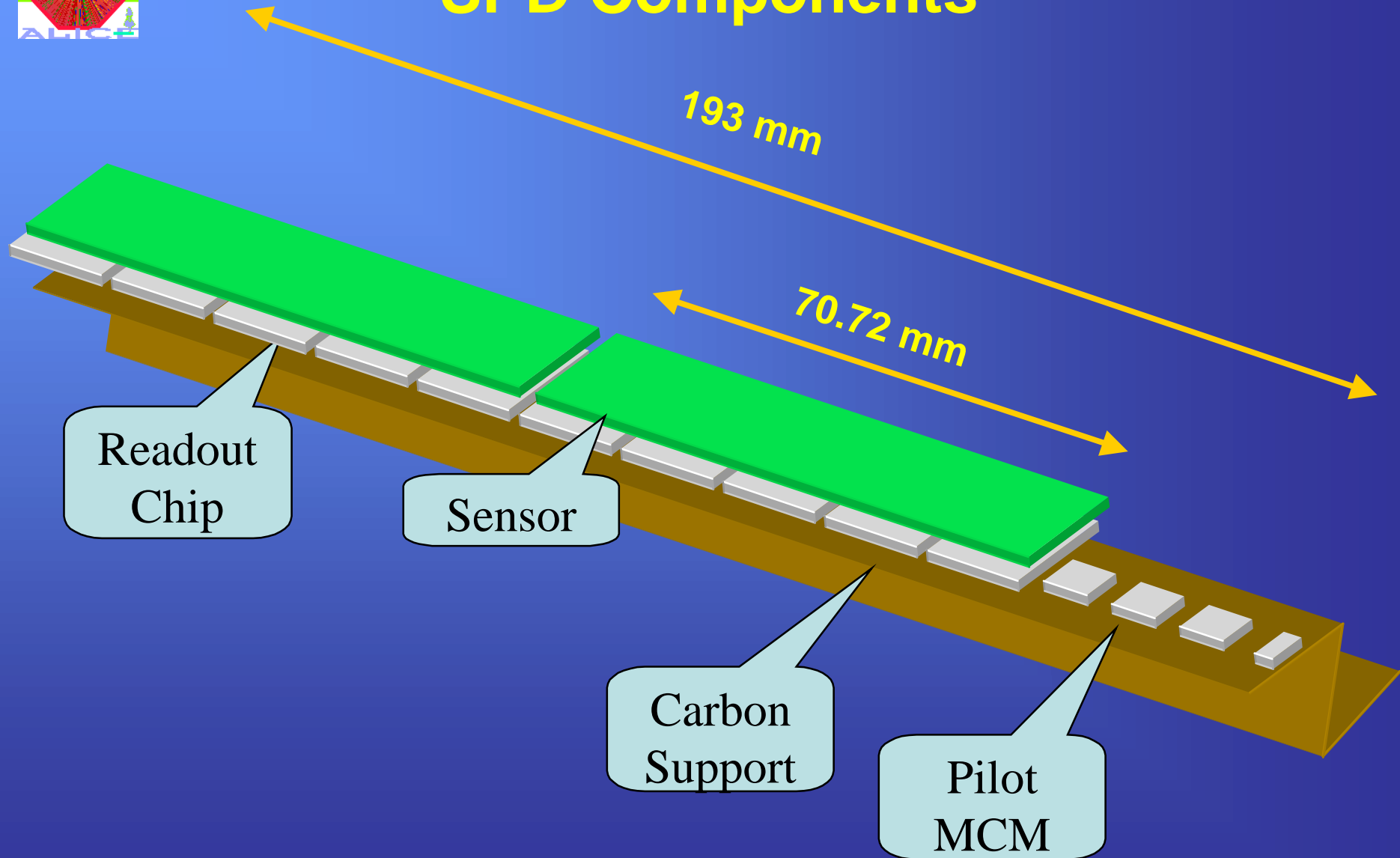



# SPD Components

## Chips:

- single chips
- 750  $\mu\text{m}$  thick

## Sensors:

- single sensors (12.8 x 13.6  $\text{mm}^2$ )
- ladder sensors (12.8 x 70.72  $\text{mm}^2$ )
- p-in-n
- 300  $\mu\text{m}$  thick
- produced by Canberra

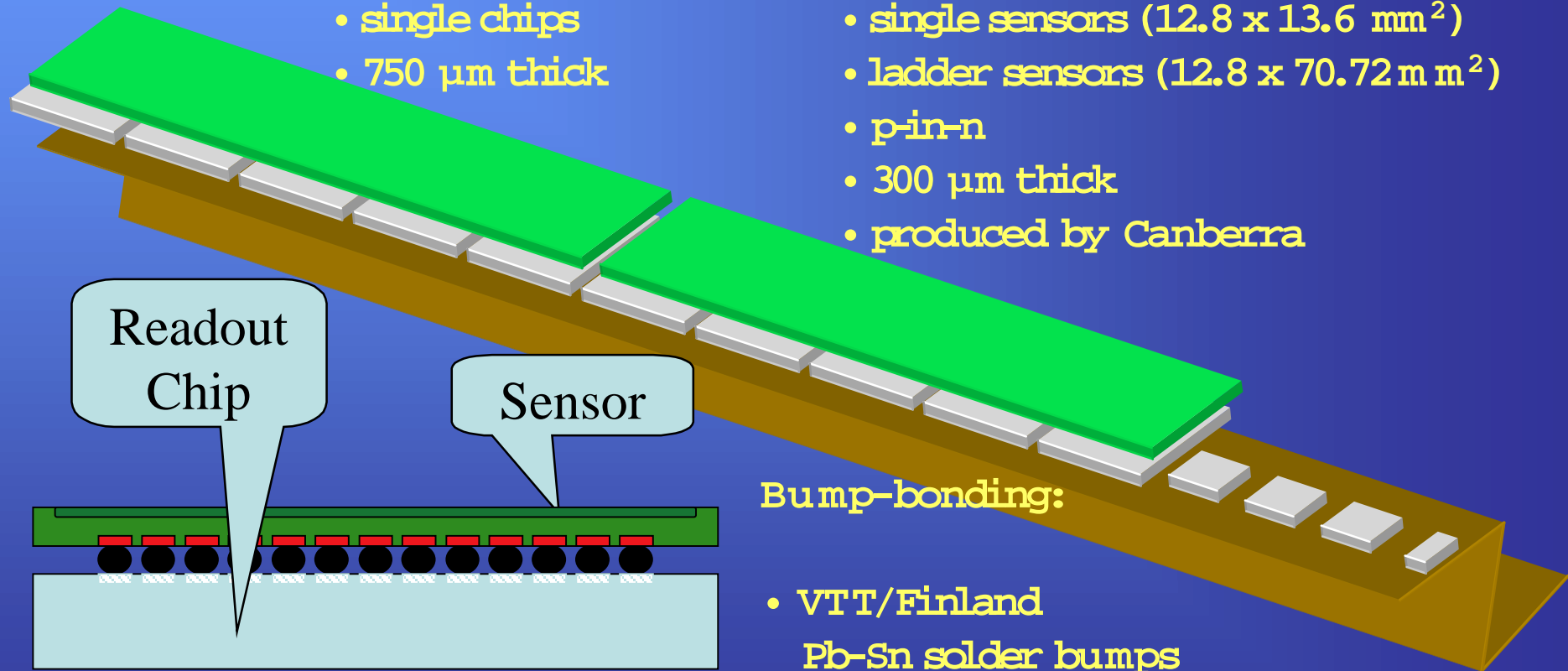

## Bump-bonding:

- VTT/Finland  
Pb-Sn solder bumps
- AMS/Italy  
In bumps



# SPD Components

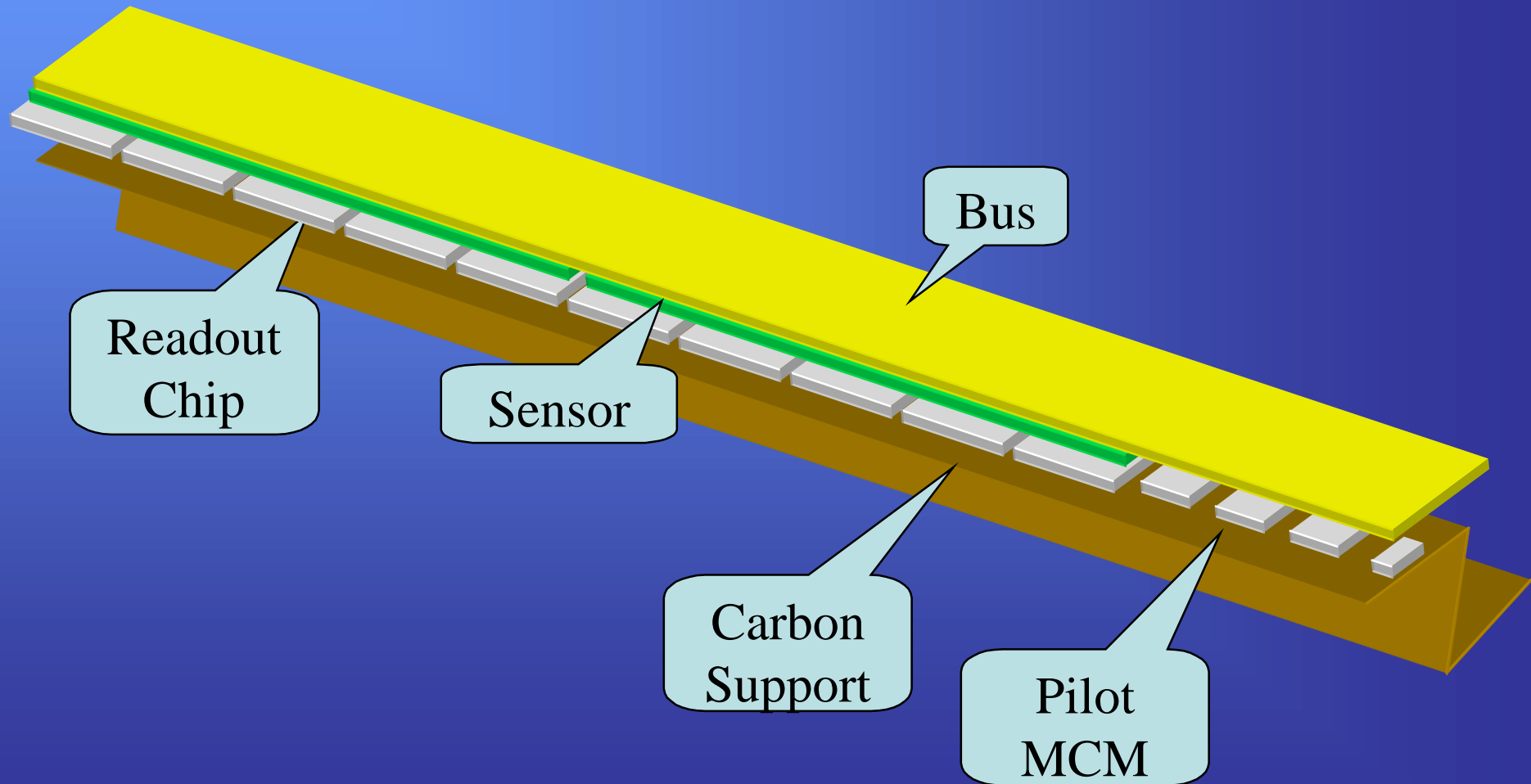

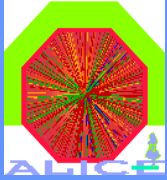

# SPD Components

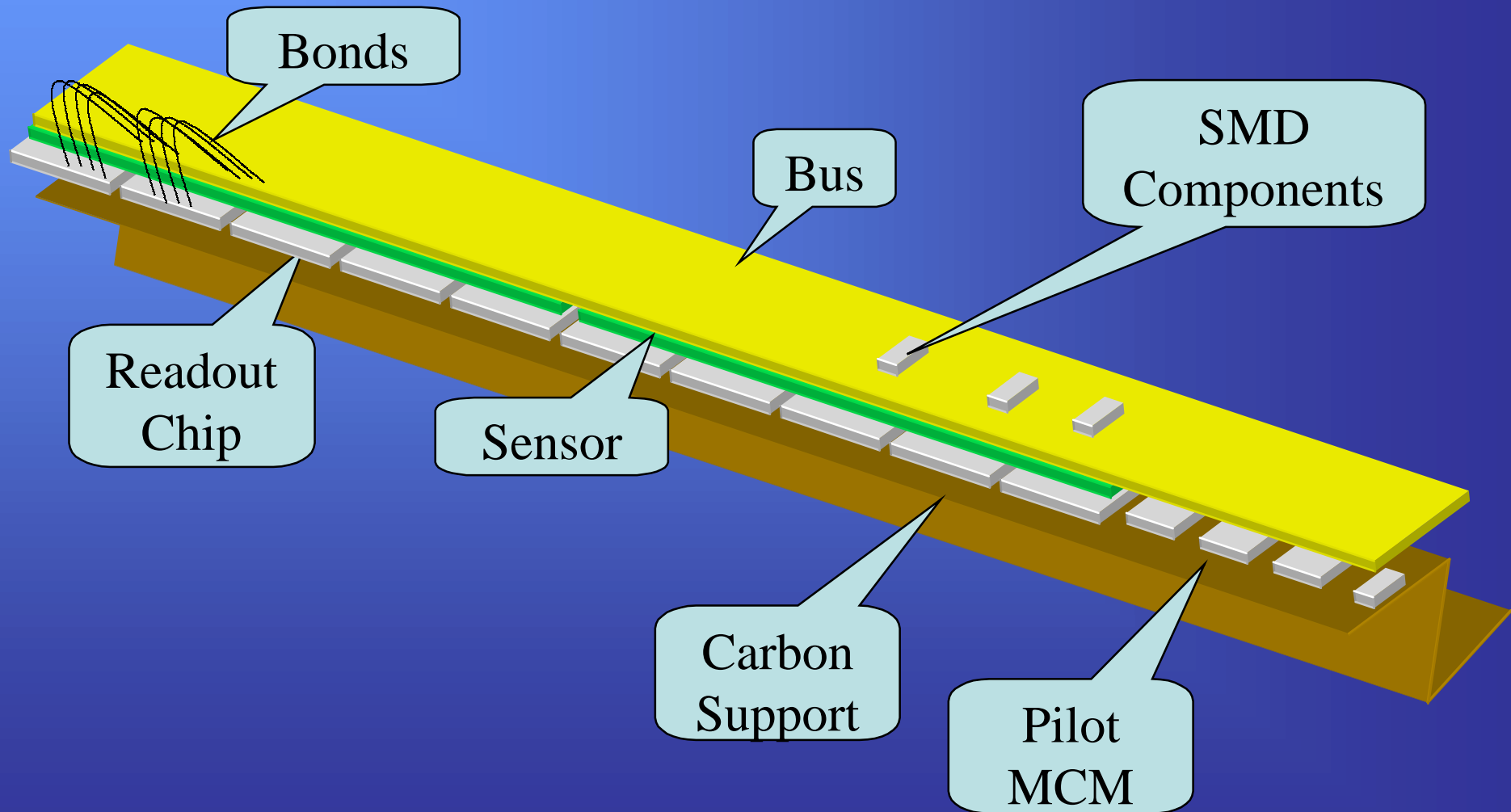



# SPD Bus

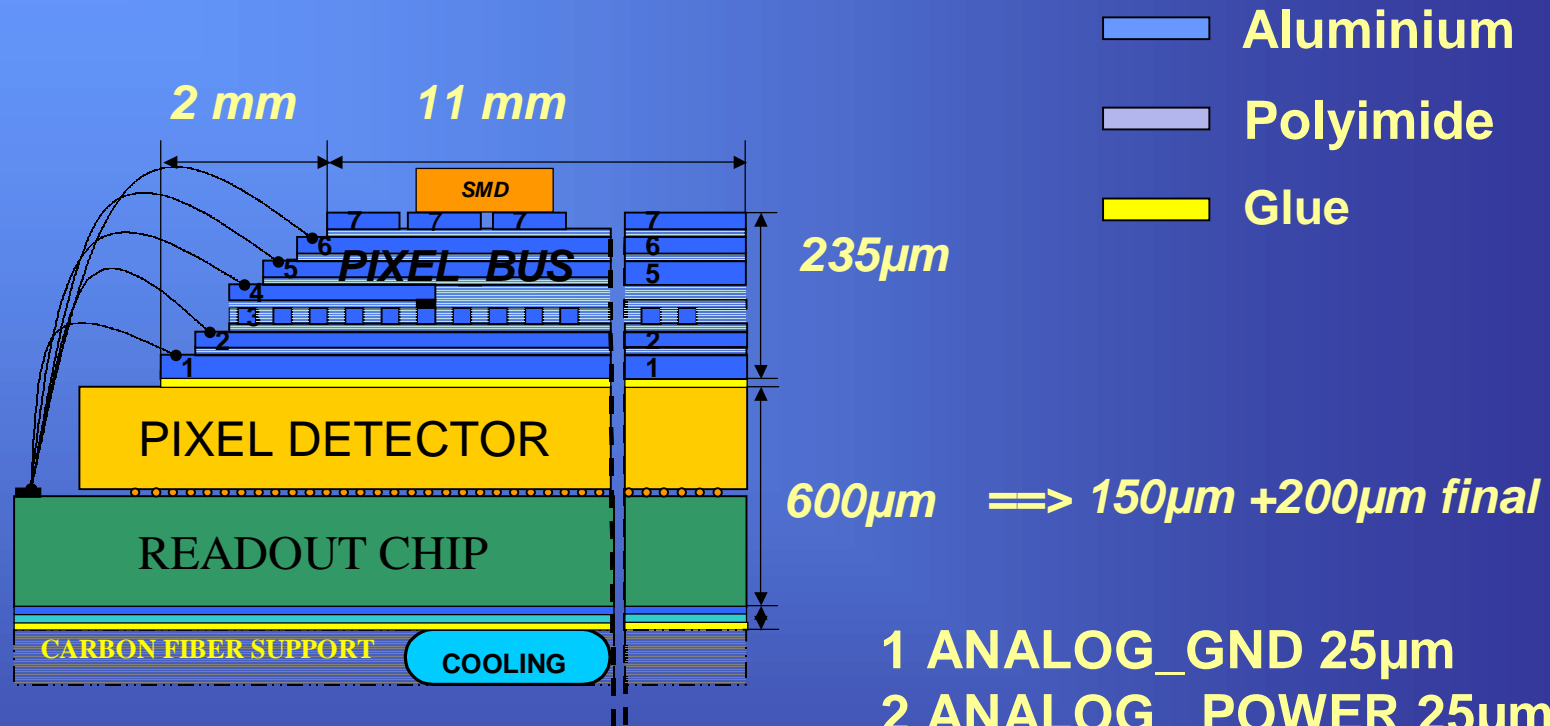

- 1 ANALOG\_GND 25 $\mu$ m
- 2 ANALOG\_POWER 25 $\mu$ m
- 3 HORIZONTAL LINES 10 $\mu$ m
- 4 VERTICAL LINES 5 $\mu$ m
- 5 DIGITAL\_POWER 25 $\mu$ m
- 6 DIGITAL\_GND 25 $\mu$ m
- 7 RES + CAPA PADS 15 $\mu$ m



# SPD Bus Tests

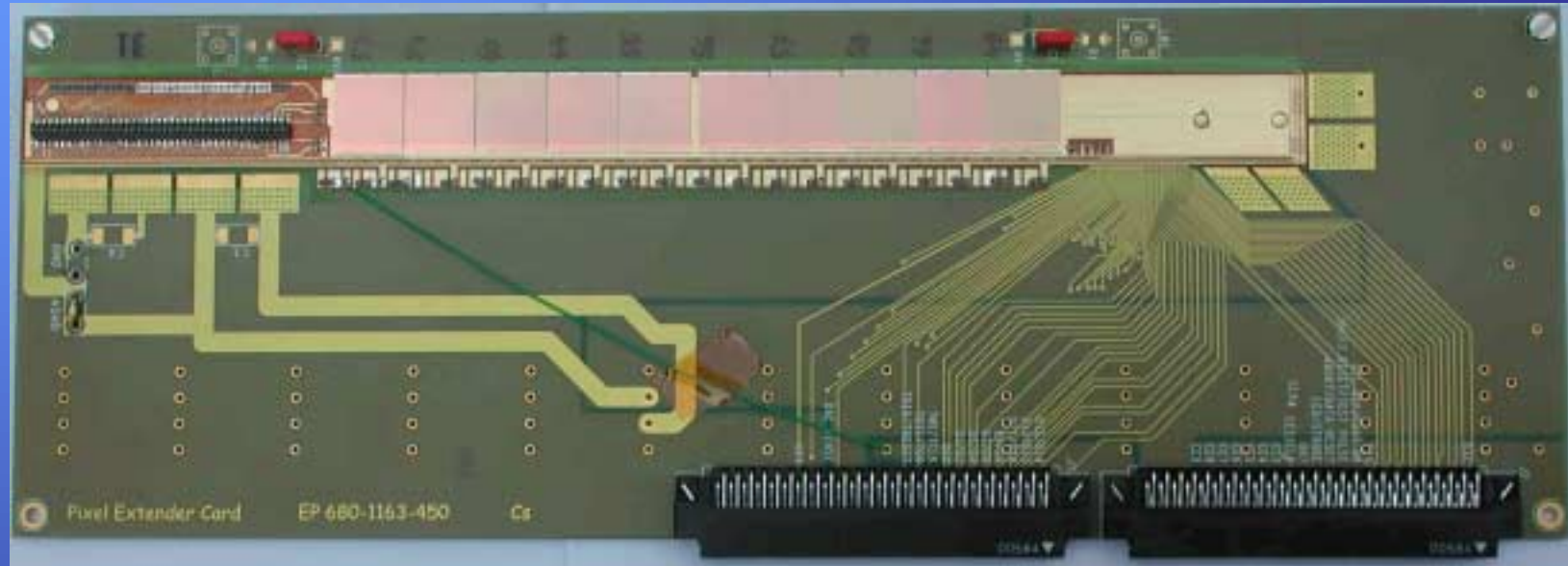

**As of today, we successfully tested:**

- **First Bus prototype with 10 mounted chips**
- **Ladder with 5 chips mounted on bus (with beam)**



# SPD segmentation

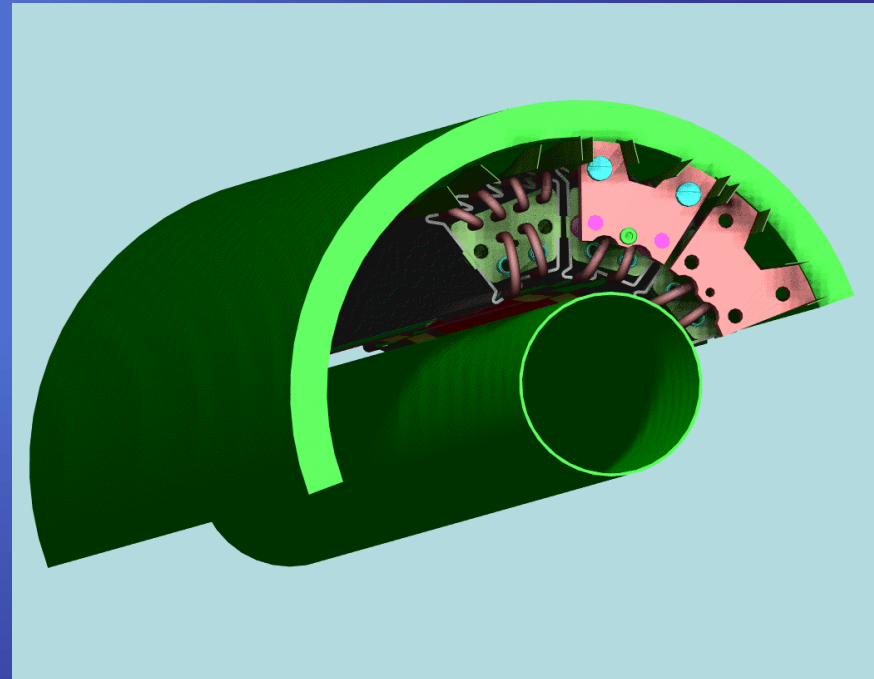
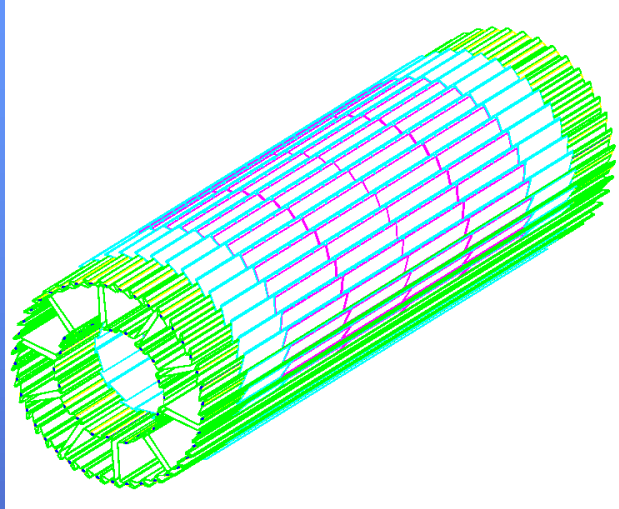

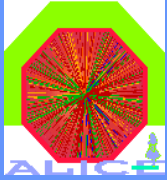

# SPD segmentation

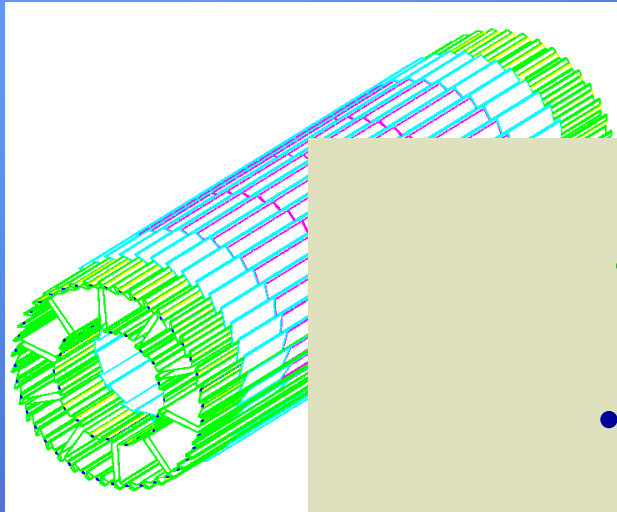

- 2 layers
- 60 staves
- 240 ladders
- 1200 chips
- 9.83 E6 active channels

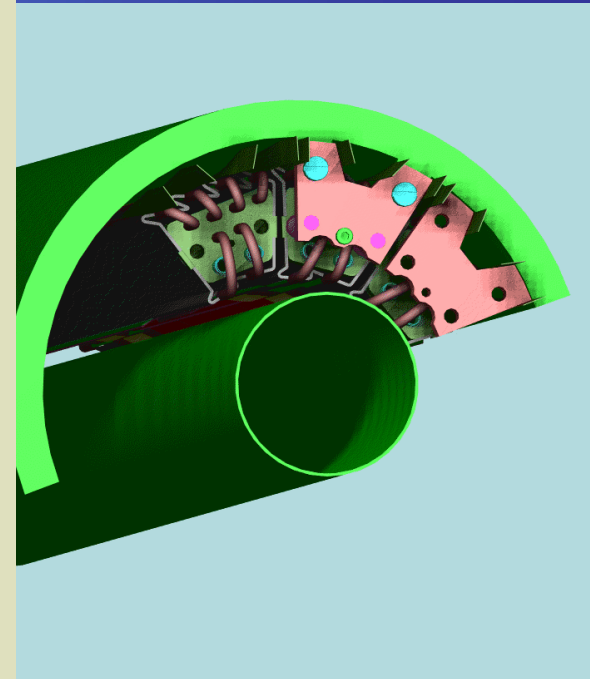





# The Pilot Multichip Module (MCM)

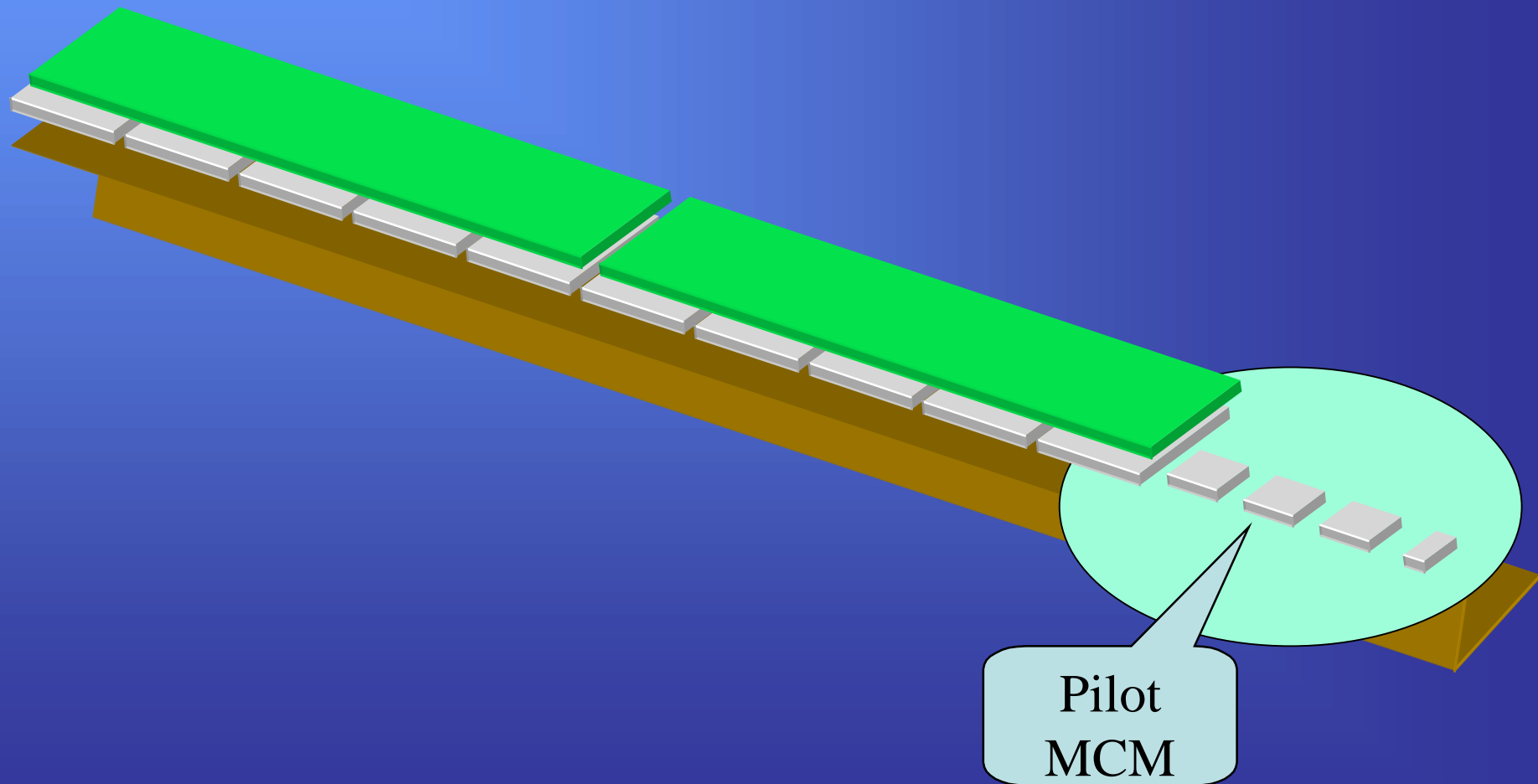



# The MCM

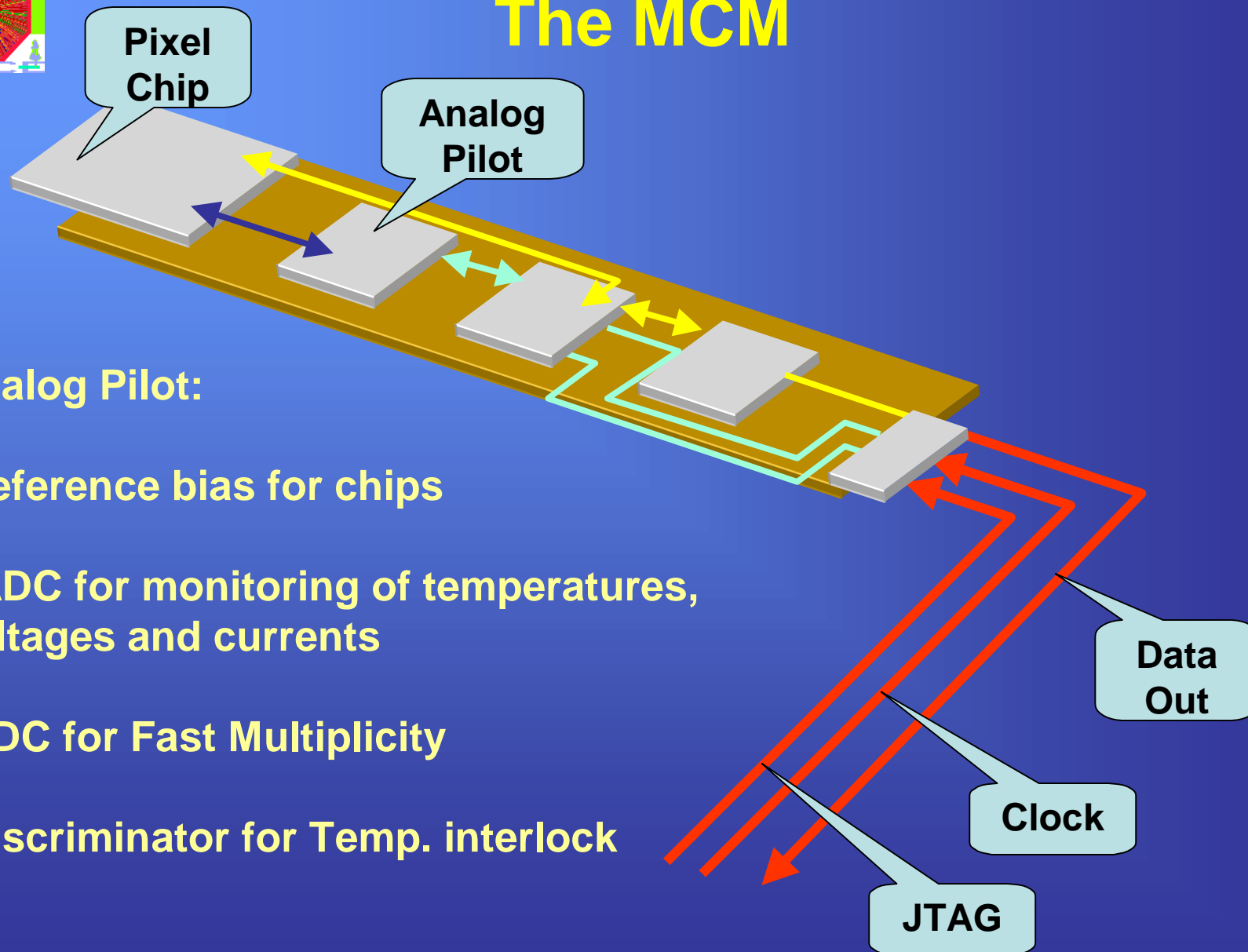



# The MCM

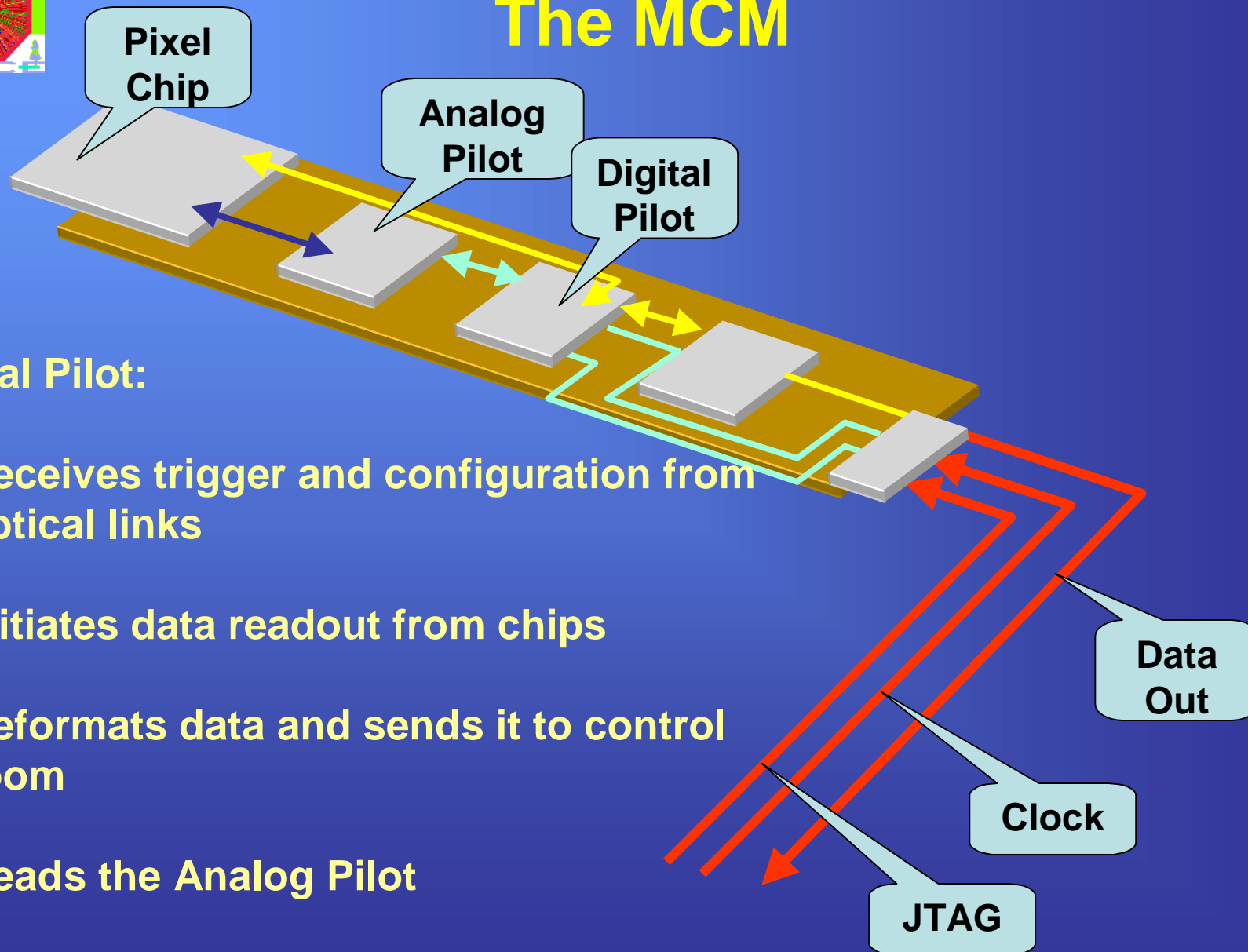

## Digital Pilot:

- Receives trigger and configuration from optical links
- Initiates data readout from chips
- Reformats data and sends it to control room
- Reads the Analog Pilot

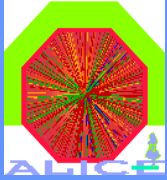

# The MCM

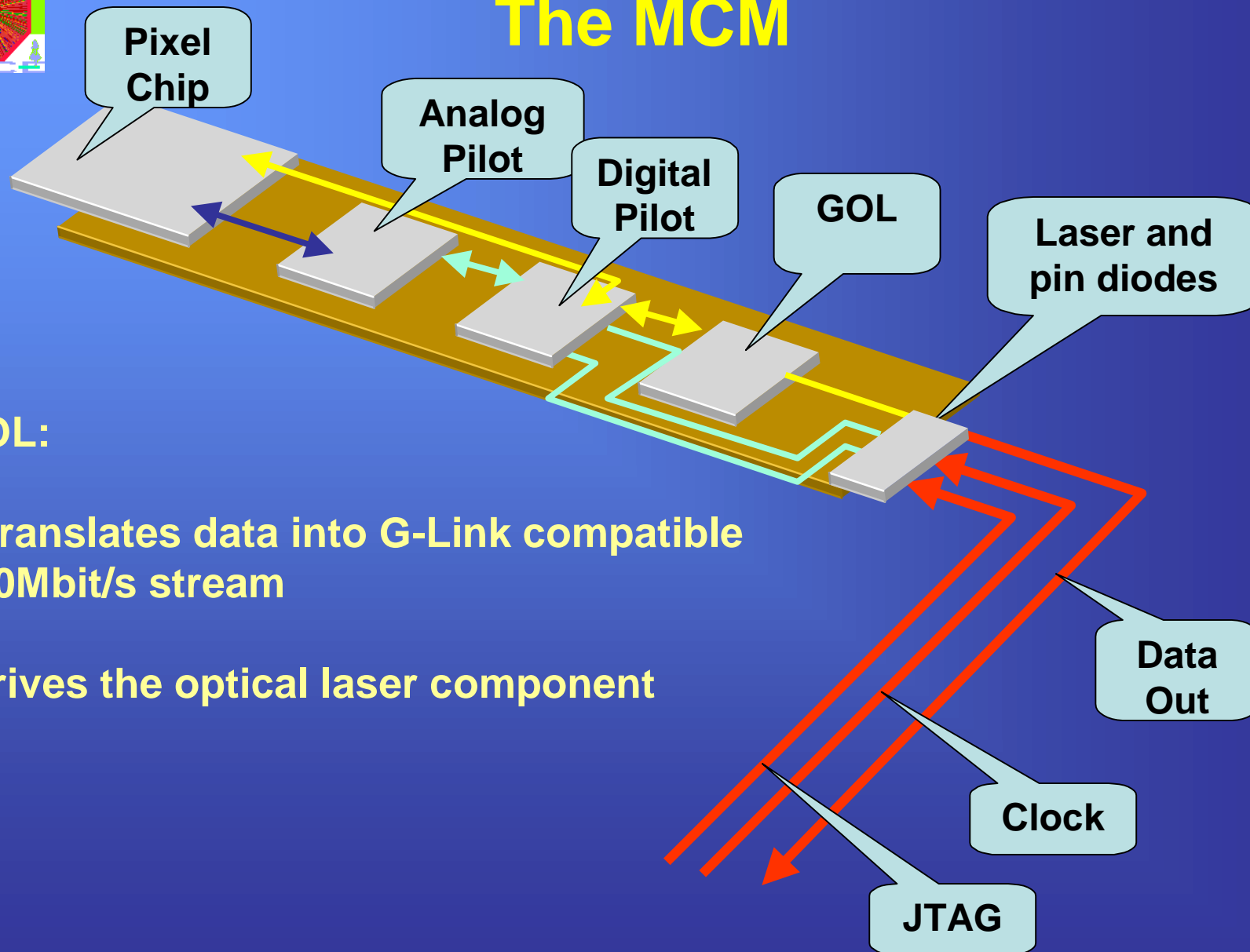

## GOL:

- Translates data into G-Link compatible 800Mbit/s stream
- Drives the optical laser component



# SPD Power Distribution

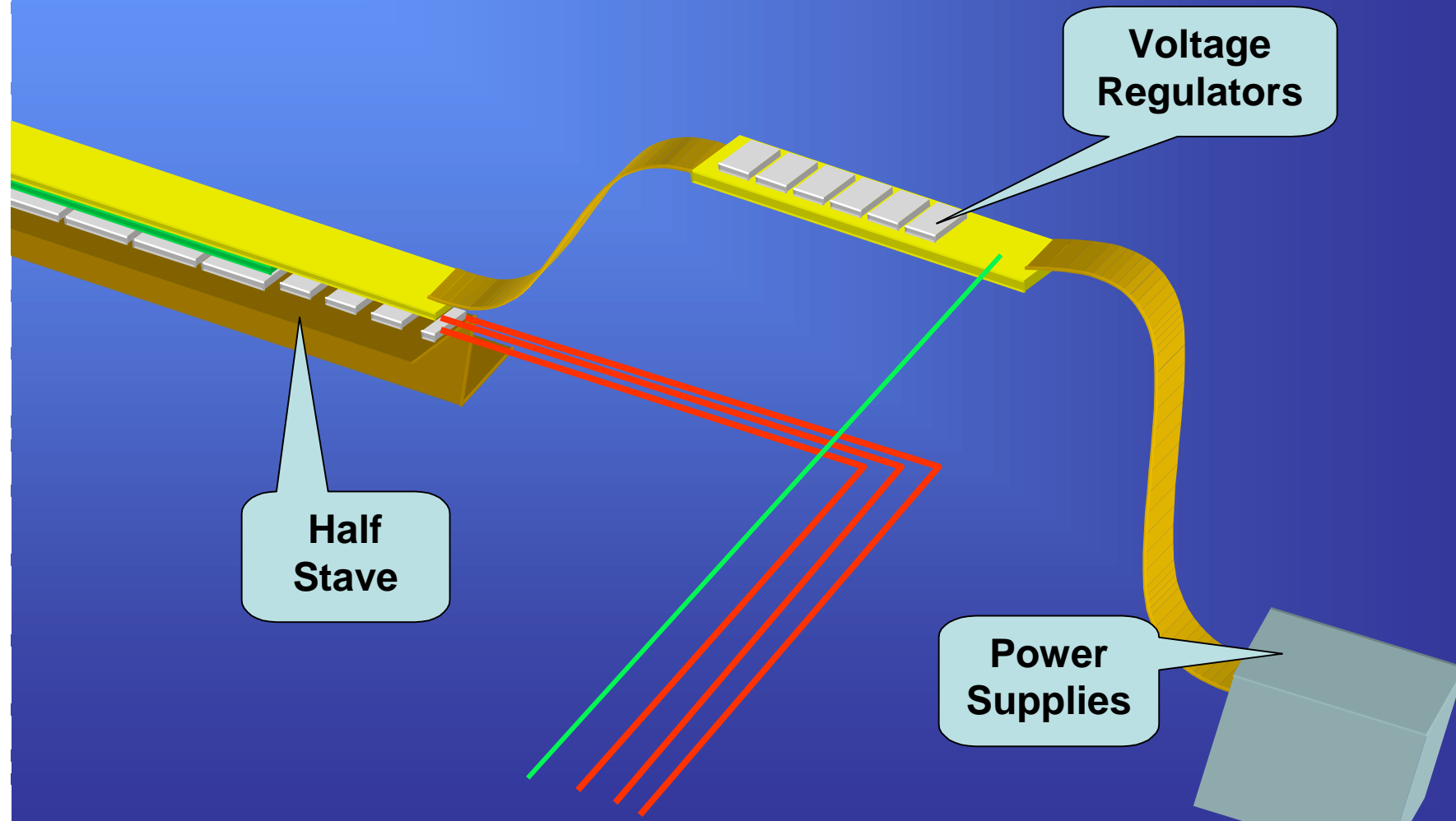



# SPD Readout Structure

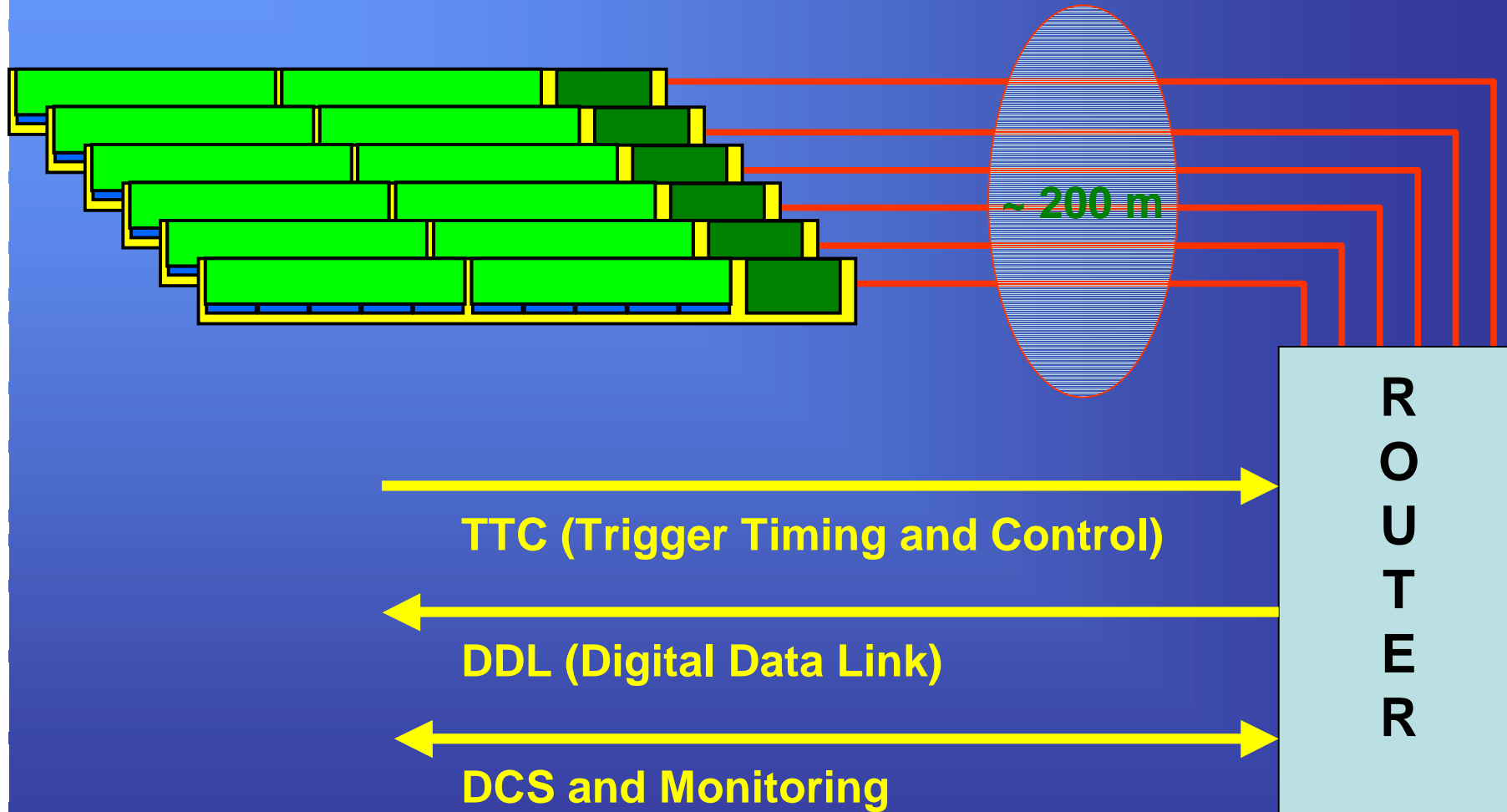



# SPD Cooling

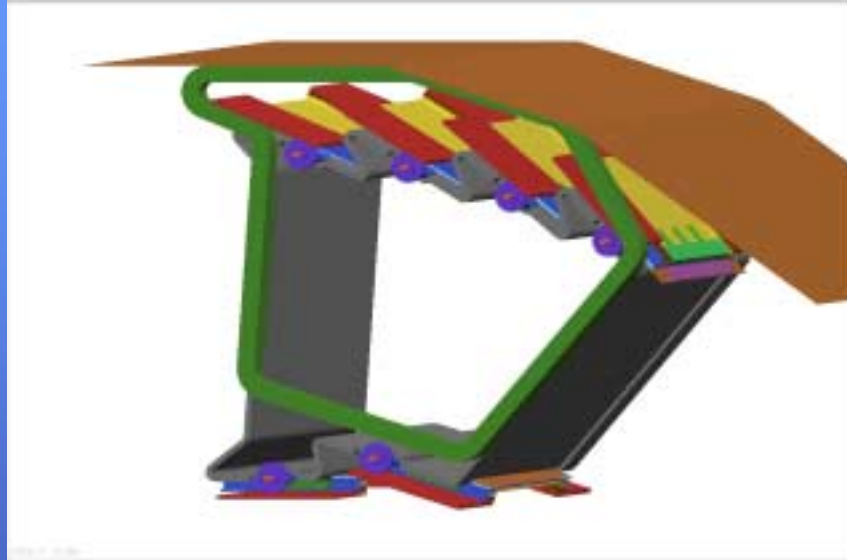

**~1.5 kW of dissipated power will be removed by a two phase evaporative cooling system**

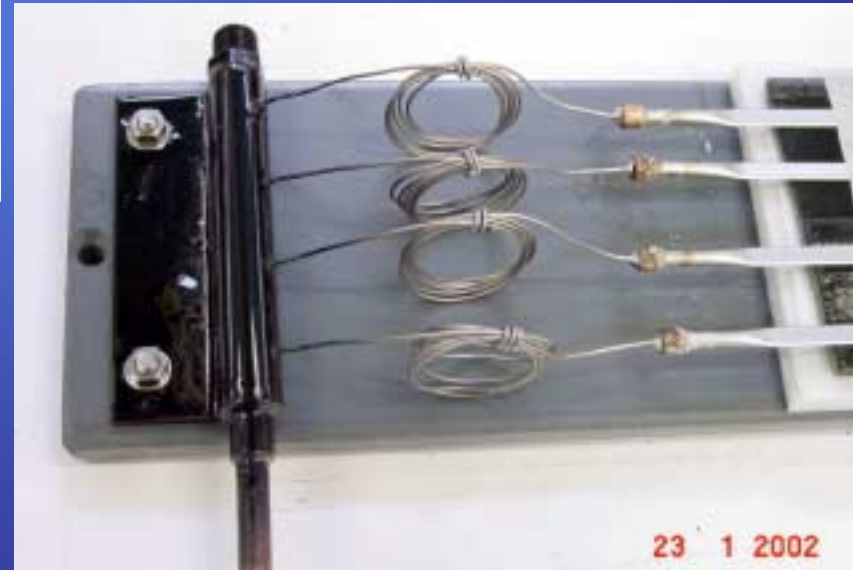

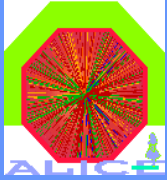

# SPD Cooling Tests

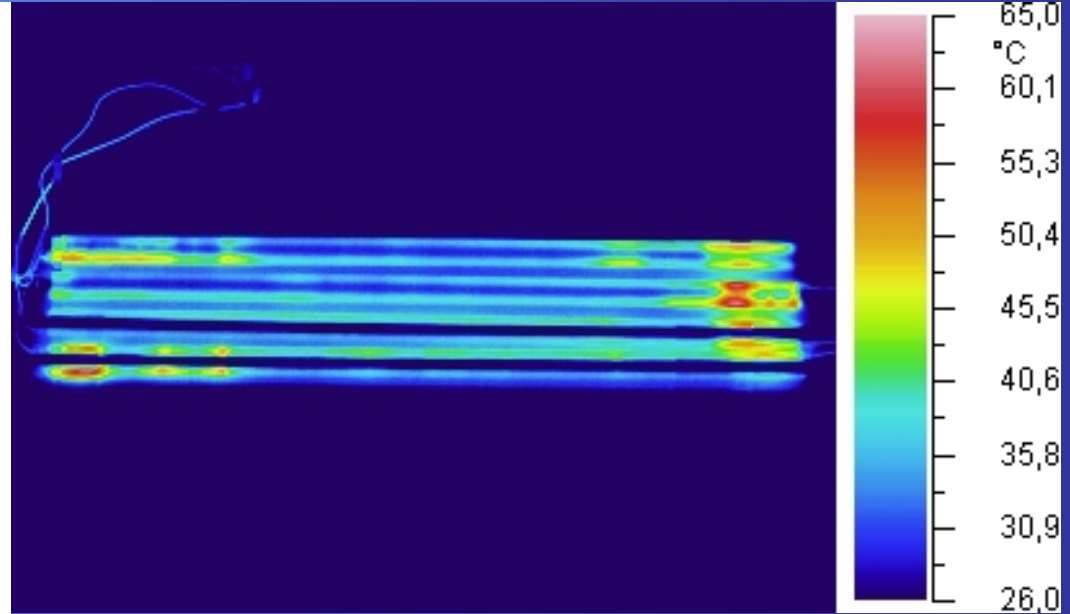
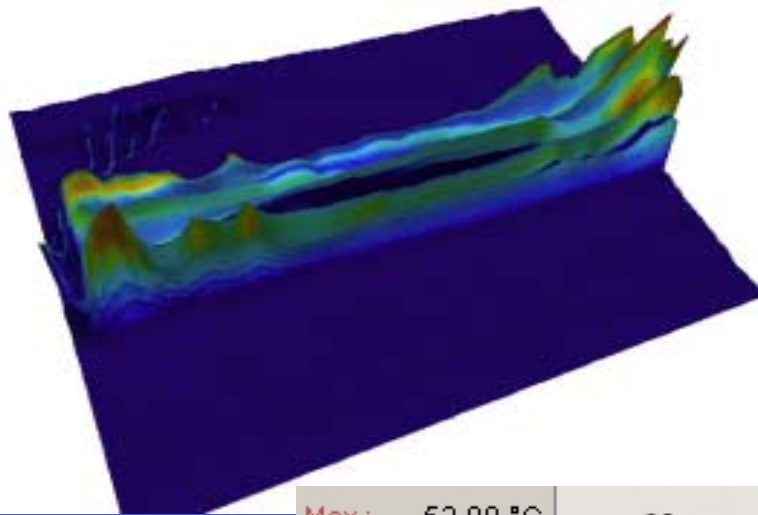

Max : 53,80 °C  
Avr : 31,42 °C  
Min : 27,95 °C  
Temp: 34,36 °C  
FstP (x/y): 18/108  
LstP (x/y): 298/113  
Points : 281

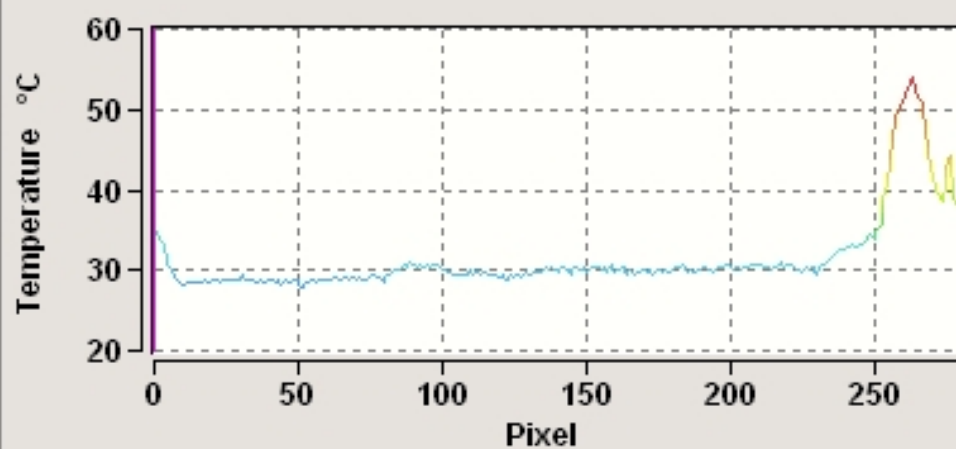





# Alice Pixel Test Systems

- **Modular System based on VME**
- **Designed for wafer probing, chip studies and testbeams**
- **Control software based on Windows, LabView and open standards (VISA, ADO, MySQL, root)**



# Pixel Test System Components

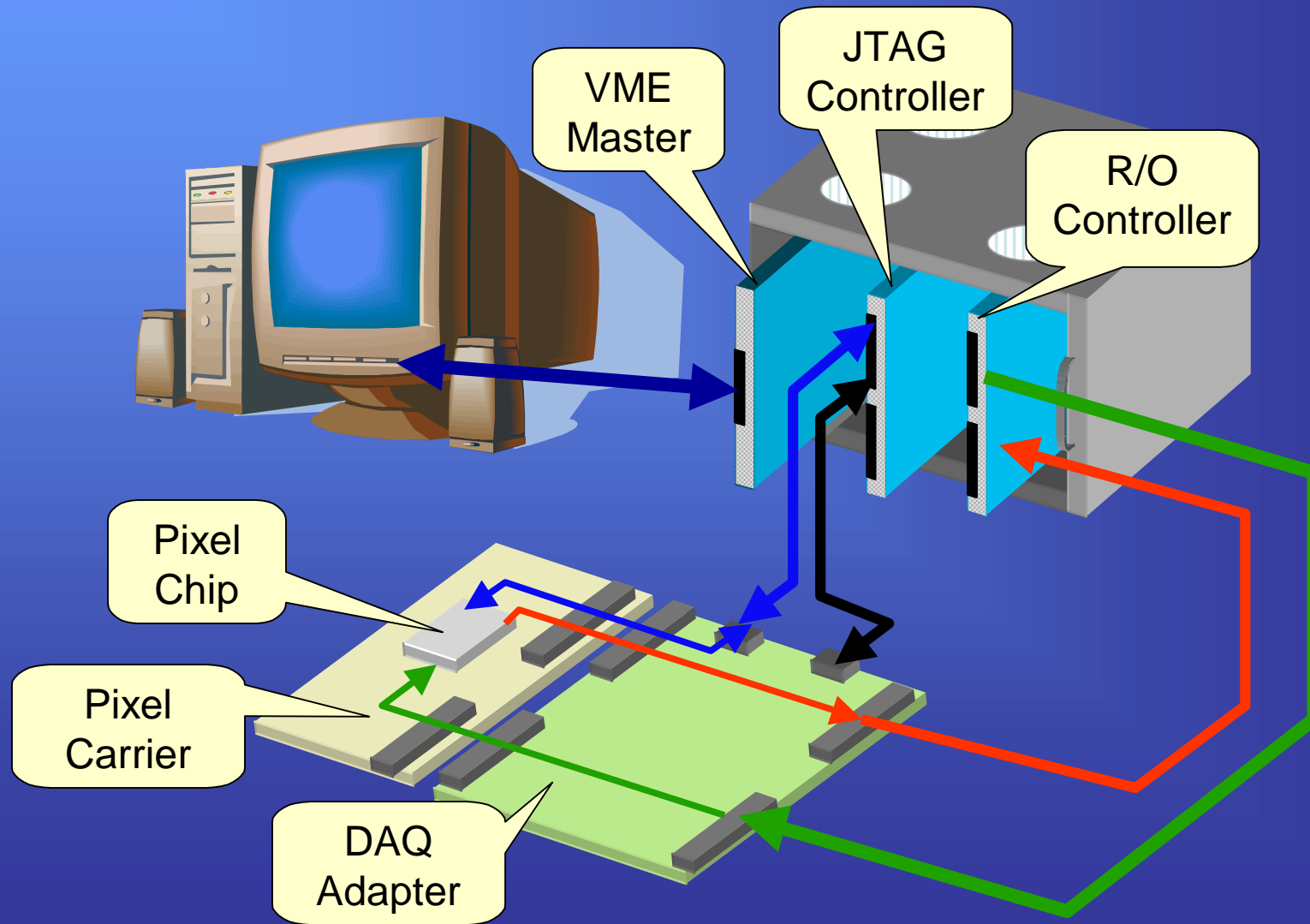



# Test System Components

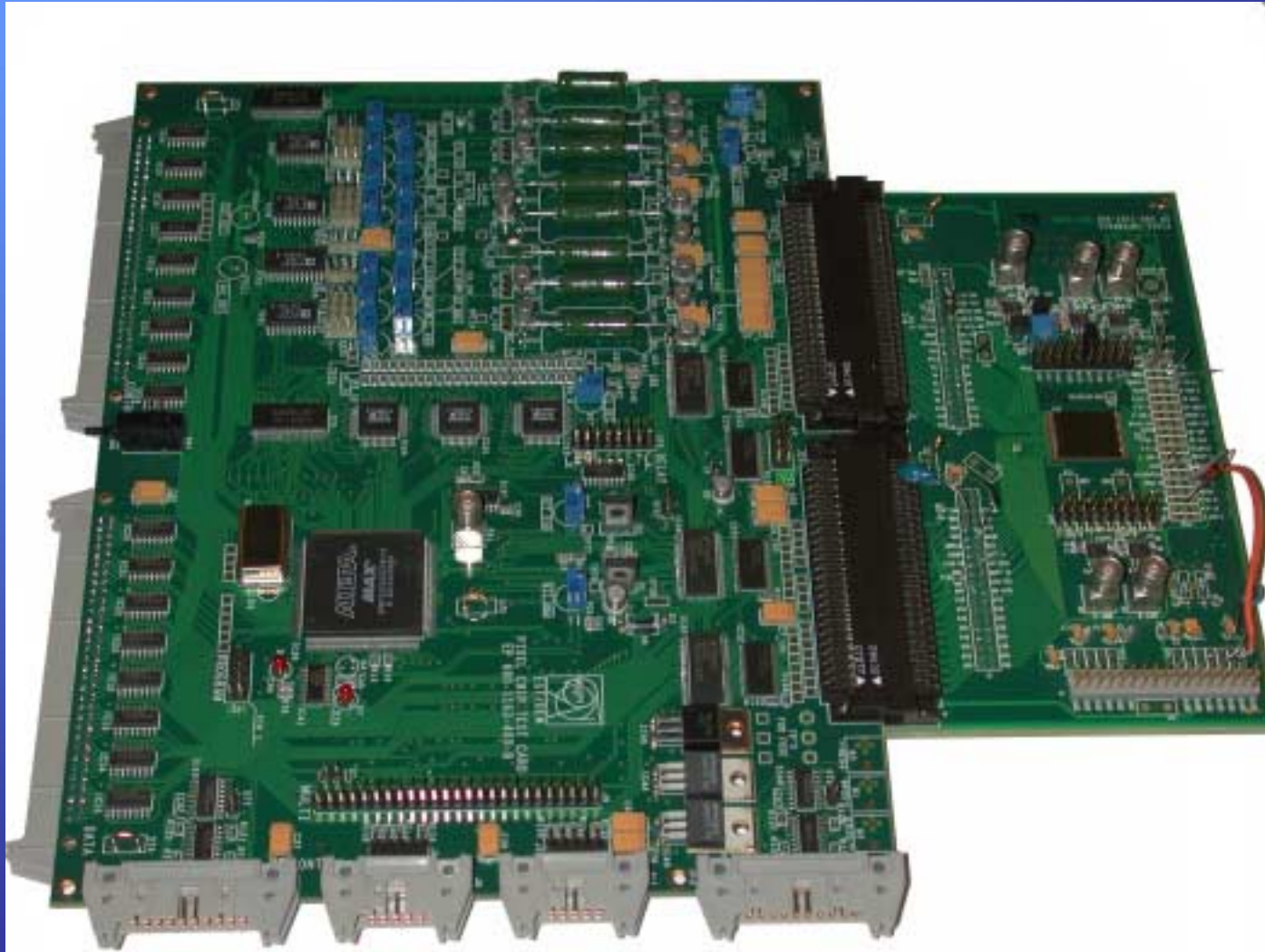

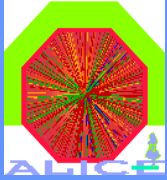

# Test System Components





# The Testbeam Setup

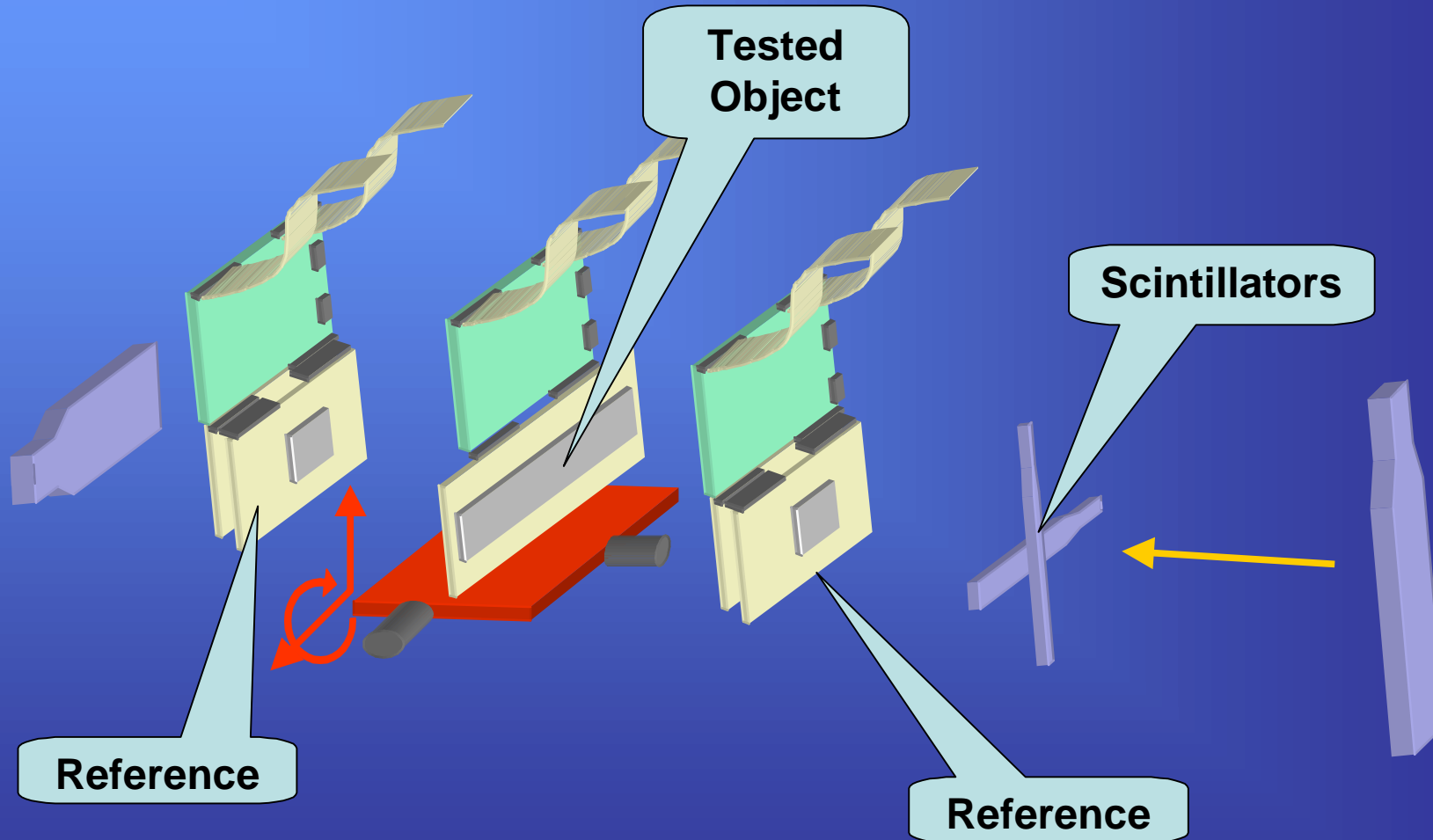



# The Testbeam Setup





# Pixel Chip Tests

- **Laboratory test protocol includes:**
  - **Power consumption tests**
  - **Tests of configuration registers**
  - **Scan of all DACs**
  - **Threshold scan**

**Full production assumes tests of ~3000 chips**

**Test System will acquire ~5.2 TB of data from chips**

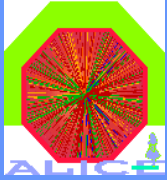

# Radiation Tolerance

## Single Event Effects:

- Studied at Louvain-la-Neuve
- No SEGR nor SEL observed
- Measure SEU rate indicates that in Alice environment it will not exceed 1bit/10hours of operation (calculated for all DACs in SPD)

## Total Ionizing Dose:

- Studied at CERN-MIC irradiation facility
- Total expected dose:
  - 130 (40) krad
- Design tolerance:
  - 500 krad
- Tested tolerance:
  - >12 Mrad





# Pixel Testbeams

- **July and September 2001**
  - 3 detector planes with single chip assemblies
  - Studies of chip efficiency, thresholds and timings
- **July 2002**
  - 5 detector planes in the beam
  - Tests of thinned assembly
  - Tests of a ladder with 5 chips
  - Collection of data for simulation tuning

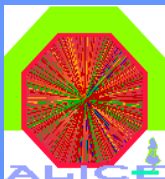

# Testbeam Software

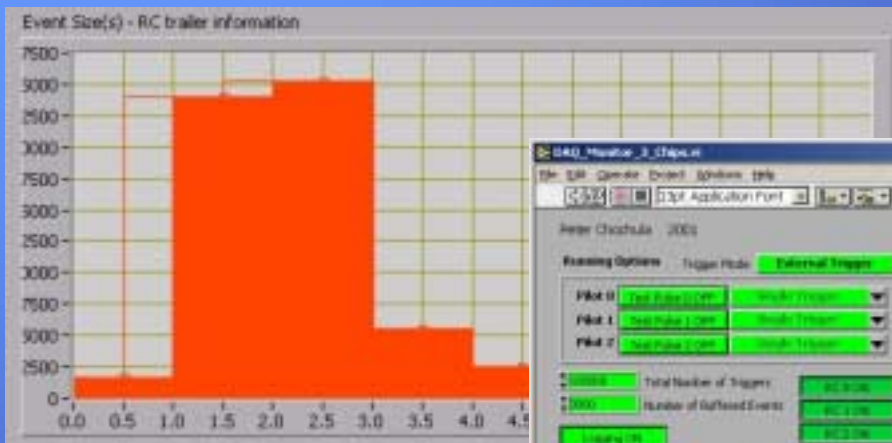

Screenshot of the Testbeam Software control interface. The window title is "DAQ\_Master\_3\_Chapec". It displays various control options and monitoring data.

**Running Options:** Trigger Mode: External Trigger, Run Rate: 100, Run Mode: Run.

**Filter Settings:**

Filter	Filter Name	Filter Type	Filter Size	Filter ID
Filter 0	Test Beam (Data)	Mask Trigger	10000	Pre_VTH1
Filter 1	Test Beam (Data)	Mask Trigger	10000	Pre_VTH2
Filter 2	Test Beam (Data)	Mask Trigger	10000	Pre_VTH2

**Monitoring Data:**

- Total Number of Triggers: 10000
- Number of Buffered Events: 10000
- Actual Trigger Rate [Hz]: 100
- Average Trigger Rate [Hz]: 100
- Number of applied triggers: 10000
- Actual Rate: 100
- Rate Readout Cycle: 100

**Occupancy - Chao:** Two occupancy charts showing the distribution of events in the detector. The x-axis is labeled [R] and the y-axis is labeled [M].

**Trigger Summary:**

Trigger	Count	Rate	Efficiency
Fixed peak 0	10000	100%	100%
Valid triggers 0	10000	100%	100%
Empty Triggers 0	0	0%	0%
Invalid Triggers 0	0	0%	0%
Fixed peak 1	10000	100%	100%
Valid triggers 1	10000	100%	100%
Empty Triggers 1	0	0%	0%
Invalid Triggers 1	0	0%	0%
Fixed peak 2	10000	100%	100%
Valid triggers 2	10000	100%	100%
Empty Triggers 2	0	0%	0%
Invalid Triggers 2	0	0%	0%

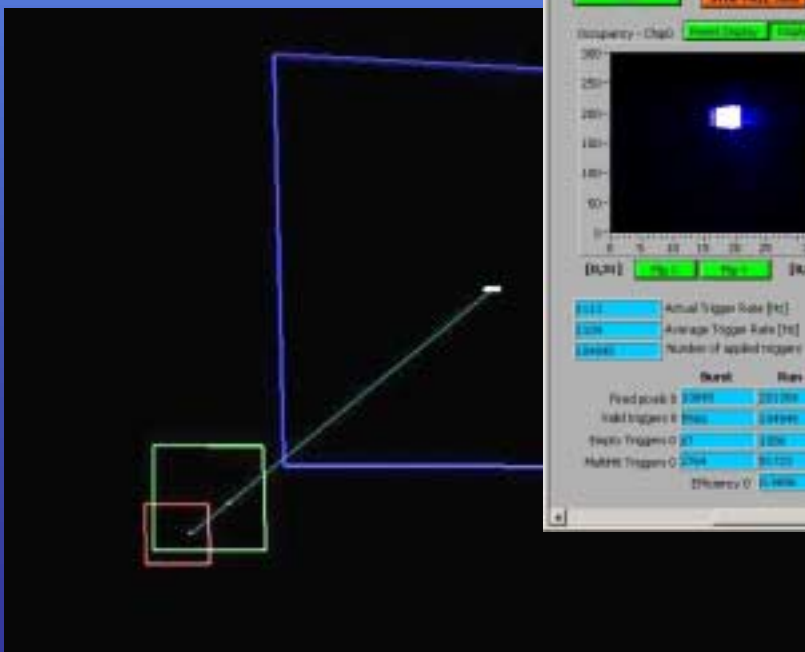
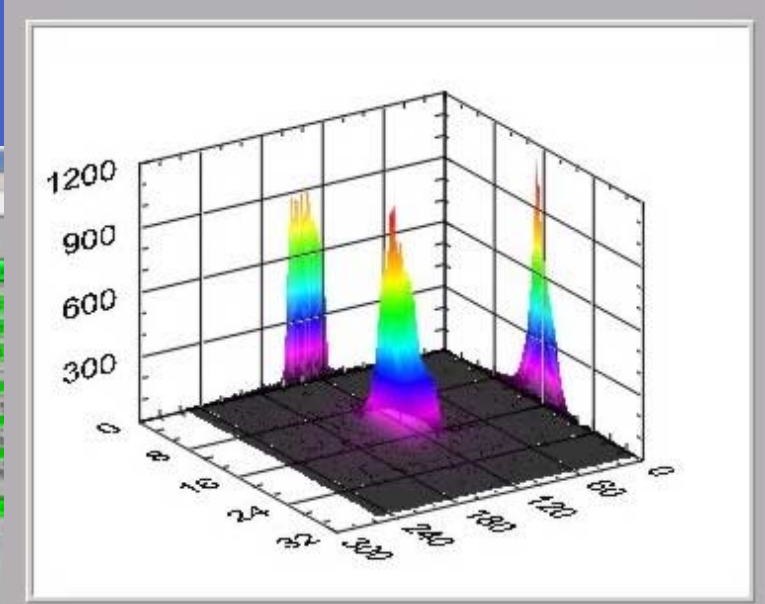

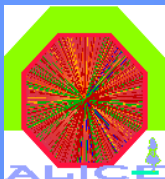

# Beamspot measurements

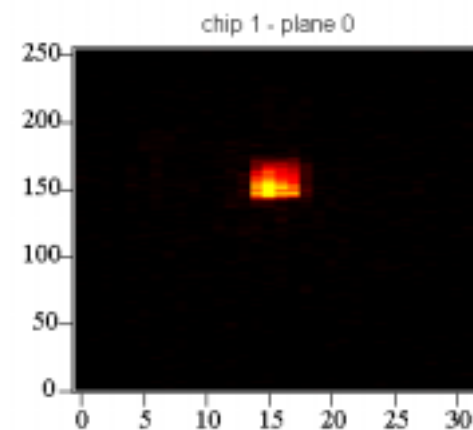
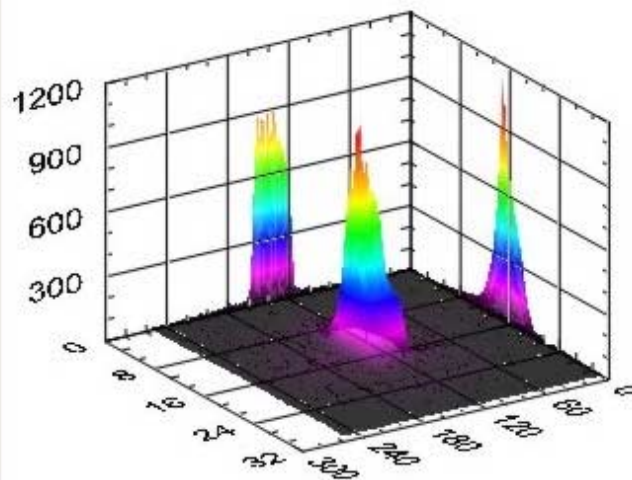
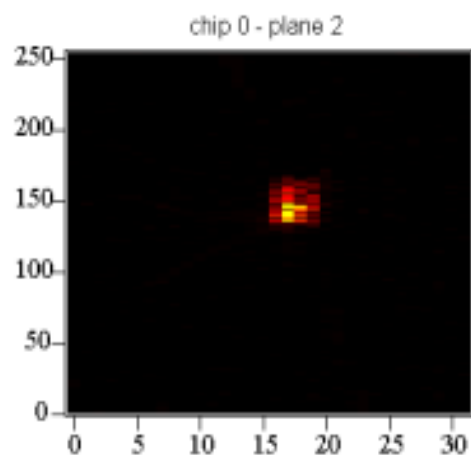
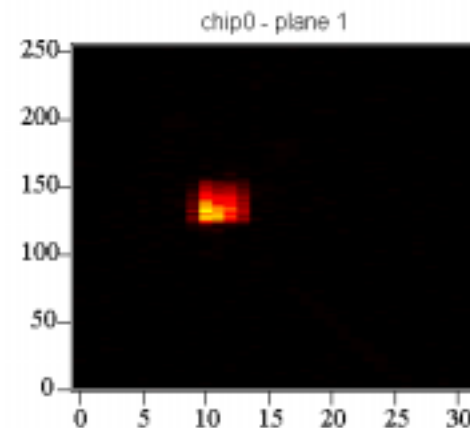
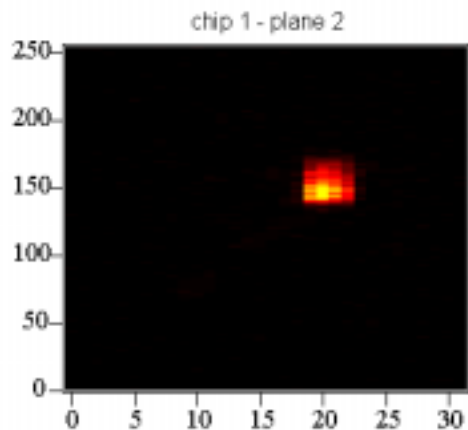
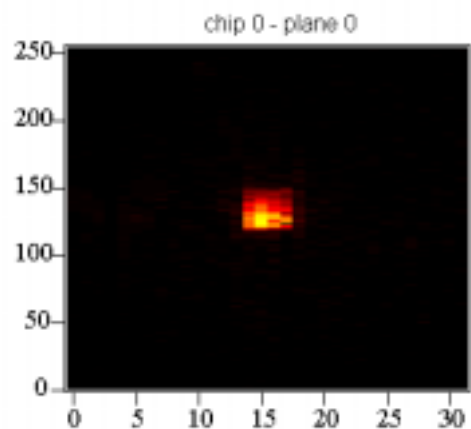

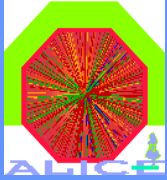

# First Results of the Testbeam 2002

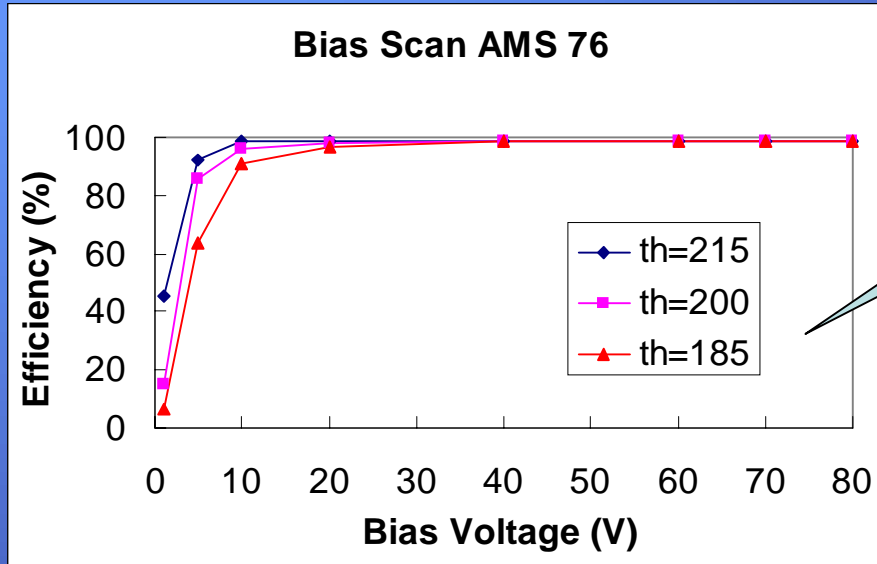

Single Assembly

Ladder

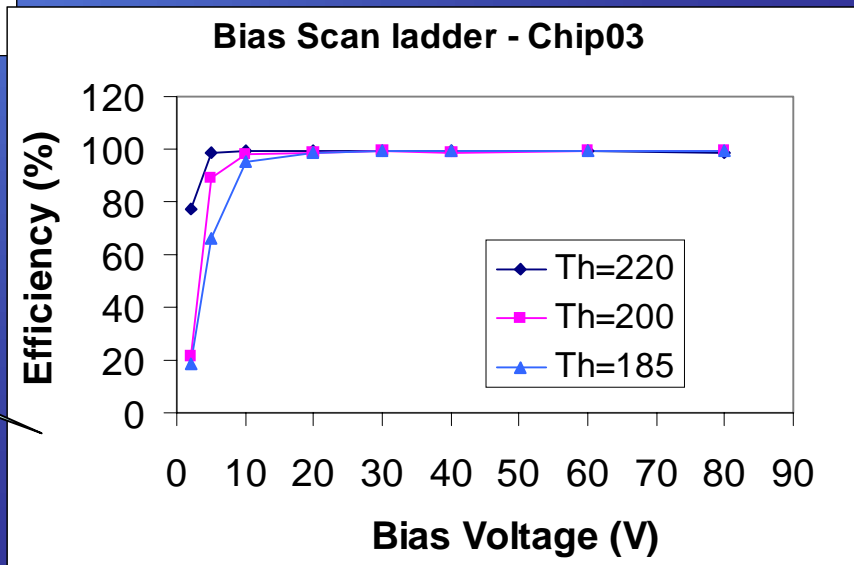



# First Results of the Testbeam 2002

### Threshold scan AMS76

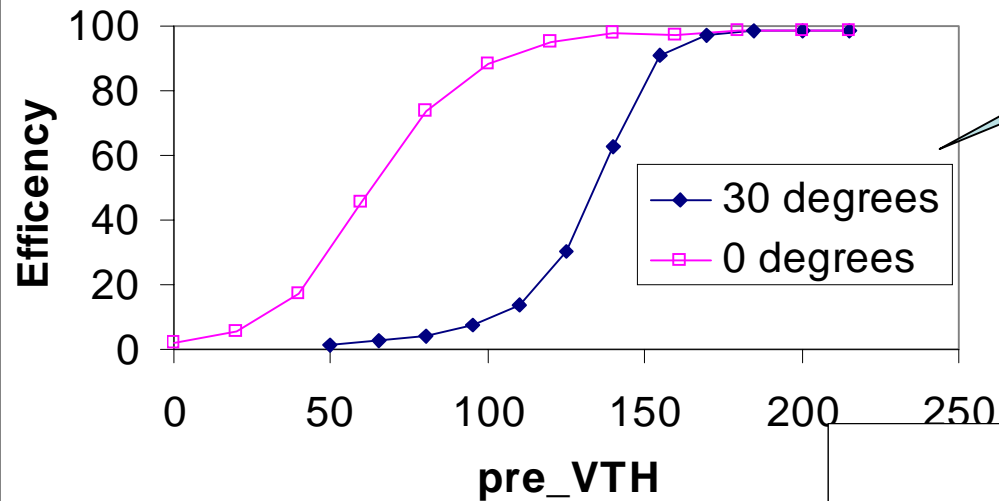

Single Assembly

### Threshold scan (LADDER-Chip02)

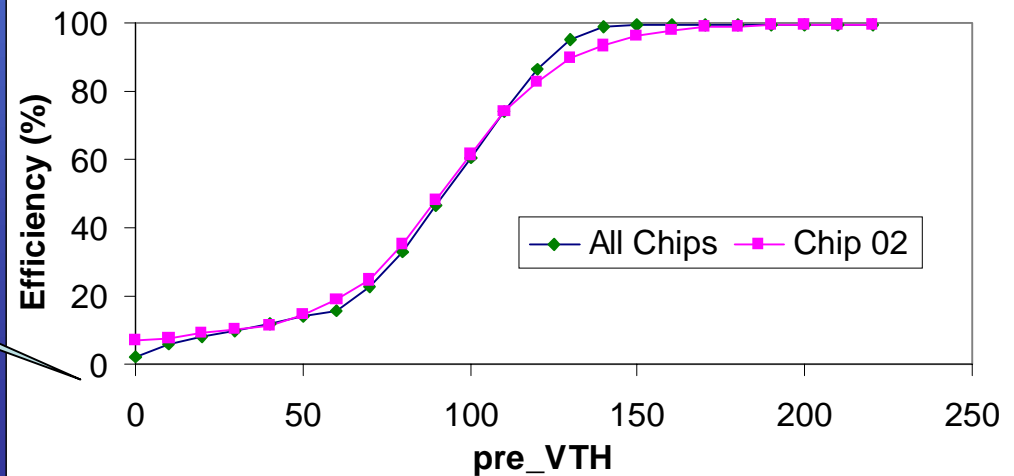

Ladder

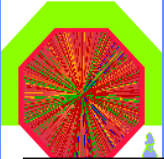

# First Results of the Testbeam 2002

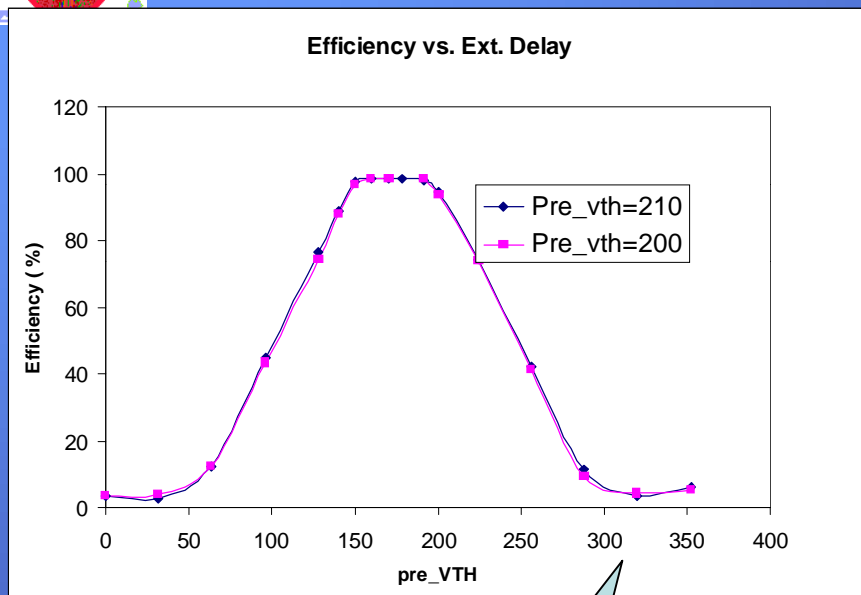

Thin Assembly

Ladder

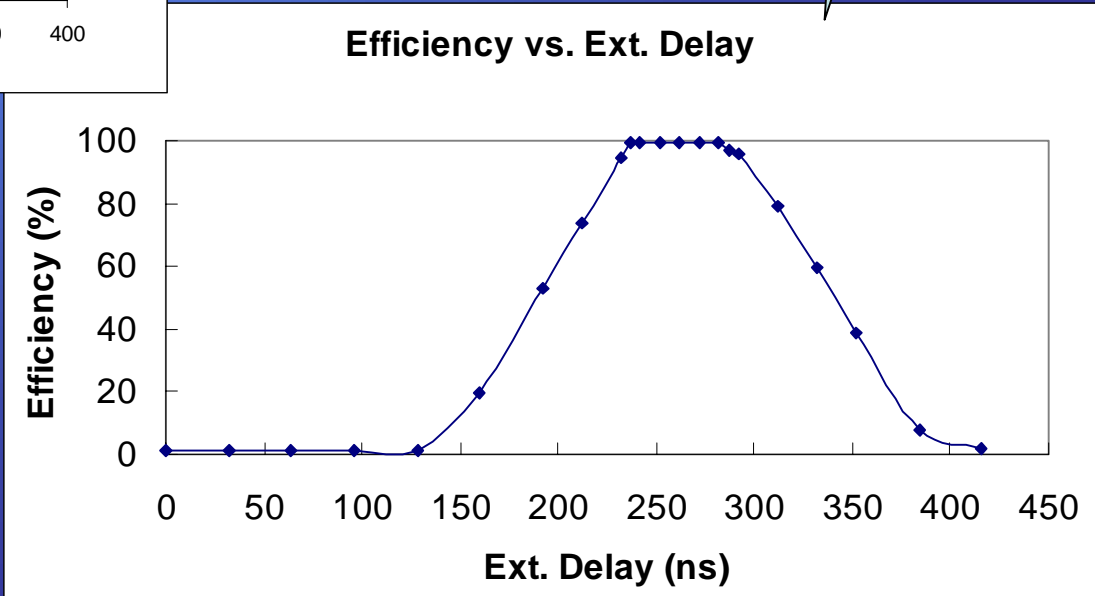



# Conclusions

- **The Alice SPD made a big progress**
- **The Alice1 chip has been qualified for use in the Alice Experiment**
- **Procedures of sector assembly are under development**
- **Next challenge – system integration**