

## The Anthropomorphic Biped Robot BIP2000

B. Espiau  
INRIA

655 Avenue de l'Europe  
38330 Montbonnot, France  
*Bernard.Espiau@inrialpes.fr*

P. Sardain

Laboratoire de Mécanique des Solides  
SP2MI, BP179  
86960 Futuroscope Cedex, France  
*Philippe.Sardain@lms.univ-poitiers.fr*

### Abstract

*This paper describes the progress of the BIP2000 project. This project, in which four laboratories are involved for 4 years, is aimed at the realization of the lower part of an anthropomorphic biped robot. The project covers mechanical design, control studies and computer architecture integration. The robot includes two legs, two feet, a pelvis and a trunk. It has 15 active joints. The mass distribution, the kinematics and the capacities of the robot in terms of joint torques are close to the ones of humans. The transmissions are specific screw/nuts-based systems which have good dynamic performances, and small size. They are arranged in parallel at the ankles and at the trunk/pelvis linkage. The control schemes either are based on a control of the center of mass associated with suitable task functions, or take dynamically into account the unilateral constraints foot/ground. At the present state of the project, the robot has been built and tested; the computer control architecture has been realized and connected with the robot; basic control schemes are implemented and advanced ones have been tested in simulation.*

### 1 Motivation

Within the world of mobile robots, legged machines are of great interest. Their ability to pass obstacles or to move on uneven terrain in a low-invasive way is in general better than that of wheeled robots. When considering structured environments, especially indoor, biped systems look particularly well-suited for climbing stairs, walking through corridors or moving in rooms designed for human occupancy. This is due to the principle of biped locomotion, which combines high capacities of mobility with a small convex hull of contact points. Besides, the drawbacks of a biped robot, compared for example to an hexapod, are of

two main types. First, the mechanical design of legs is more difficult, since contradictory issues have to be taken into account: compactness, lightness, high joint torques, large joint range, low backlash and friction. Secondly, because the system is naturally unstable, control methods have to be very efficient and safety aspects are mandatory, any fall being strictly forbidden.

Therefore, and perhaps more than in other fields of robotics, the quality of achievement of a biped robot relies on a tight cooperation between researchers in mechanics, in automatic control, in real-time computer architectures and in all involved technological issues. This was the case in 1997 when Honda demonstrated his humanoid robot [4], showing thus definitely the feasibility of such a system.

In 1995, a french group of laboratories with complementary expertizes launched a research project aimed at the realization of an anthropomorphic biped robot. A first motivation of the project was to explore the feasibility of building a biped robot with human-like displacement ability, in view of improving human-robot interactions. A second issue lied in the problem of gait analysis and control. The connection between the human gait study and the generation and control of appropriate robot gaits is not difficult to see: human walk is extraordinarily complex, elegant and efficient, for example in its capacity of adaptation and perhaps in regards to energy optimality (to be understood in various senses). Human walk should therefore, at least, inspire the mechanical and control design of anthropomorphic machines or be used as a reference for performance evaluation. Reciprocally, techniques originating from the robotics area may find useful applications in the domain of biomechanics, as already emphasized in several existing studies. This search for a synergy between the areas of biomechanics and robotics was the second motivation of the project.

Deliberately, the project was focused on *locomotion* issues. We did not intend to study other aspects which

would have led to a full humanoid concept. Indeed, this idea is of course fascinating and challenging. However, such a realization is a problem of technological development and integration which requires considerable human and financial support which is out of reach for a consortium of academic-style research laboratories. Furthermore, most of the needed contributions for reaching a kind of autonomy are not so different in bipeds from what we can find in the areas of classical mobile robots (motion planning, localization by vision...) or manipulators (arm control and grasping). On the contrary, the design and the control of a locomotion system are problems *specific* to biped robots, which were still opened at the project beginning.

The goal of this paper is to present the results of the project, which is now almost completed. This is the first paper presenting the whole robot, since references [1, 2, 3] only described work progress and theoretical concepts respectively. In section 2 we present the project objectives and organization; in section 3, we give technical details on the design (mechanics, sensors, software architecture); in section 4 we present an overview of the control studies associated with the project and in conclusion we propose some research perspectives.

## 2 Project Objectives and Organization

It is not our goal here to present yet another state-of-the-art in biped robots. We refer for example the reader to the review in [2], and suggest also to look at the interesting databases on legged robots which are presented in <http://www.uwe.ac.uk/clawar/>, and <http://www.mel.go.jp/soshiki/robot/undo/kajita/bipedsite-e.html>.

With respect to the state-of-the-art at the project launching, we found that two main original features had to be considered in the robot design. First, it was important to provide the robot with the capability to *maneuver on partially unknown and uneven terrain* and secondly, the integration of *anthropomorphic characteristics* still was to some extent a challenge. Following the objective of designing an indoor robot, we restricted the first requirement to the capacity of walking on slightly inclined plane surfaces and up/down stairs, without a-priori knowledge. Although the second requirement was closely related to visual aesthetics, it was also, to us, a challenge to be able to capture some essential feature of gracefulness as it is applied to human locomotion. A further consequence of this choice was that the design of the robot

was inspired by human anthropometric data and dynamic capabilities.

Besides these general objectives, we also considered that the robot should be a reliable test-bed for scientific studies in automatic control, in computer architecture and in mechanical design. This led us to decide that the quality of realization was a major concern, in order to be sure that the biped lifetime was long enough. This is why the necessary time for completing the design and build prototypes was kept; we also used an important part of the financial support acquiring high quality components and carefully realizing specific parts of the robot when needed.

The project was started in 1995, with a first milestone in 1998 (prototype leg) and the objective of having the robot completed and walking early 2000. Its overall cost, including all material, salaries and overhead expenses is about 1.5 M\$. The mechanical hardware with its control system costs about 100 k\$. Four Laboratories are involved in the project. The main present BIP team members are:

**BIP-INRIA Grenoble:** B. Espiau (BIP Project Leader), with researchers and students. The control development is done by R. Pissard-Gibollet's group.

**LAG-CNRS Grenoble** (e-mail contact: [canudas@lag.ensieg.fr](mailto:canudas@lag.ensieg.fr)): C. Canudas de Wit (Team Leader) with researchers and students.

**LMS-CNRS Poitiers :** G. Bessonnet (Team Leader), P. Sardain (Researcher), and students.

**LMP-CNRS Poitiers:** A. Junqua (Team Leader).

The activities of the project are distributed among the partners according to their main domain of expertise. INRIA is concerned with the theoretical and practical issues of the real-time control of the system: study of natural cycles and stabilizing control design; modeling and simulation of interactions; control architecture design. LAG works on automatic control aspects and dedicated modeling problems: optimal control design; friction modeling and control; impact analysis. LMS is responsible for all the mechanical design of the system: dynamical analysis and optimization; design of the actuation components, of the basic mechanisms and of the overall structure; related biomechanical issues. Finally, LMP provides the project with the theoretical aspects and experimental facilities for studying human motions with the point of view of sport-oriented biomechanics.

### 3 Description of the Robot

#### 3.1 Kinematics

Although the BIP2000 robot was aimed at having anthropomorphing characteristics, we did not try to copy the human model with all the degrees of freedom used in the human walk. Knowing that the robot has neither arms nor head, we found that 15 active joints and 2 passive ones were sufficient for reasonably mimicking basic human gaits (see figure 1). This was the result of the following analysis: a minimal model in the sagittal plane has 7 links (1 pelvis-trunk, 2 thighs, 2 shins, 2 feet) and 6 parallel joints (2 hips, 2 knees, 2 ankles). For being able to turn, it is useful to divide the pelvis and the trunk into two parts rotating independently around a vertical axis and to add a vertical rotation to each hip. In order to control the motion in the frontal plane, 5 degrees of freedom in this plane are necessary: 1 for each ankle and each hip, and a kind of "lumbar vertebra". Finally, a 15th joint is useful to allow a trunk flexion. The 2 passive (elastic) joints are located in the feet, at the metatarsa level in order to recover successive heel strike, foot flat and toe off phases like in the human.

One of the original features of BIP2000 is the existence of a 3 dof linkage between the pelvis and the trunk. This choice allows when needed trunk counter-rotation and coordination of pelvis tilt and lateral trunk flexion, again like in human walk (see for example [10]). The pelvis tilt will prove also very useful in walking down and up stairs, by reducing the load of support ankle and knee while allowing the swing leg to recover the contact faster. A frontal view of the pelvis is given in figure 2.

#### 3.2 Transmitters

Five joints are equipped with classical Harmonic-Drive Gears: the 3 rotations of vertical axes Z6, Z9 and Z15 and the 2 hip adduction/abduction rotations, Z7 and Z8 (see figure 1). The 10 other joints use as transmitters screw-nuts with satellite rollers combined with rod-crank systems (figure 3). The nut with satellite rollers is inserted in a slider which is guided by four rollers that can move along a straight beam. The rotation of the screw produces the translation of the slider, which itself pushes or pulls on two rods acting on an arm of the adjacent limb. These nuts with satellite rollers allow a high accuracy with low friction, and give a good reversibility to the system: for example the torque due to the weight of the leg when it is horizontal is enough to make it moving. The obtained

reduction ratio is variable, while high torque and high velocities can be transmitted (see next section). These nice characteristics of the transmission allow the possibility of a dynamical control of the joints. These transmissions are arranged in a single form for hips and knees; they are mounted in parallel in association with Cardan universal joints in the ankles (figure 4) and for achieving the trunk motion in the lateral and sagittal planes (figure 5). With respect to existing biped robots, this choice of parallel actuation systems seems to be a structural originality of BIP2000.

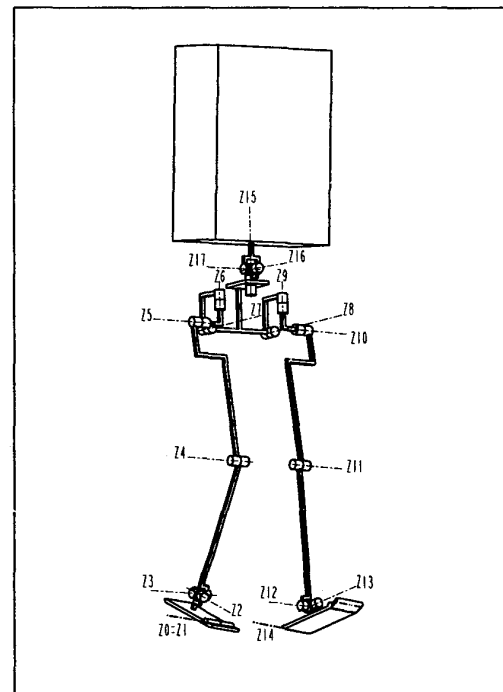

Figure 1: Robot Kinematics

#### 3.3 Lengths, Masses and Torques

The geometric parameters of the skeleton are chosen as close as possible to the ones of a human of size 180 cm. The mass distribution follows the same principle and the required capacities of the robot in joint velocities and torques are taken from data measured on human during normal walking. This leads to the following values (lengths in mm and masses in kg):

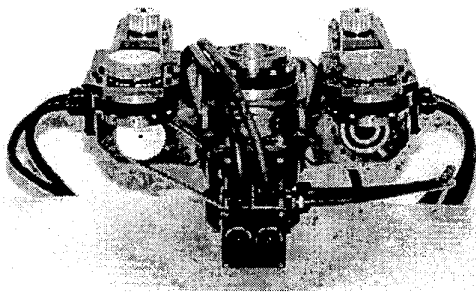

Figure 2: Front View of the Pelvis

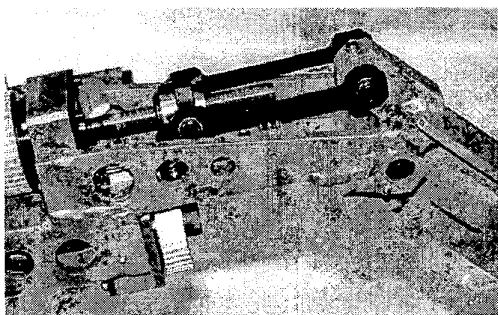

Figure 3: Structure of the Knee Transmitter

*Pelvis:* height 128; width 220; mass 17 (including motors 7.1)

*Thigh:* length 410; mass 11 (motors 5.6)

*Leg:* length 410; mass 6 (motors 2.8)

*Foot:* length 290; height 80; mass 2.5

*Trunk:* mass of the support: 7 (motors 2.2)

The payload in the trunk include parts of power units and control boards, for a total mass of 40 kg. The actuators are brushless DC motors which can lead to high performance at the joint level due to the used transmission system. For example, the knee motor has a nominal torque of 1.9 Nm, with the possibility of pulses of 5.25 Nm. Its maximal velocity is 7100 rpm. The reduction ratio varies from 55 to 115, which, taking into account some loss in the transmission, allows extremal values of 70 to 400 Nm and 10 rad/sec.

We show in figure 6 a global view of the robot skeleton (i.e without actuators) and in figure 7 a side view of the final robot with the two legs mounted. Further details on the robot design can be found in [2, 3].

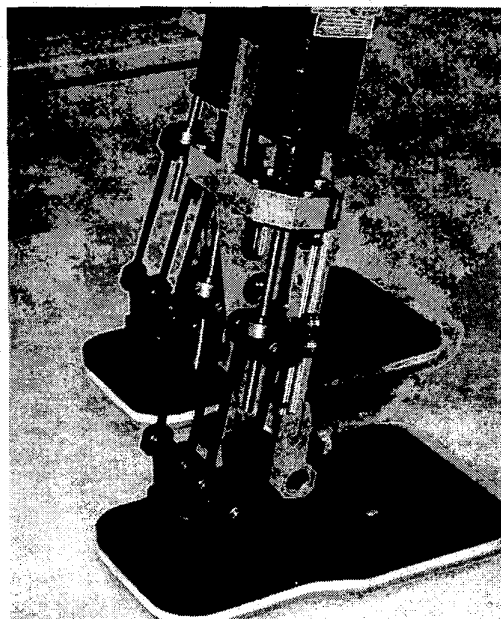

Figure 4: Parallel Actuators of Ankles

### 3.4 Sensors

Synchro-resolvers, which can emulate digital encoders, provide with the relative angular position of the motor axes. Owing to the quality of the signal, we compute the related angular velocity by direct numerical differentiation. In order to recover absolute position, analog potentiometers are directly mounted on every joint. In the pelvis, a special circular track is used. Switches located near the extremities of the straight beams indicate upper and lower joint limits.

Within the foot, 3 strain gage-based force sensors are located between the rigid part of the sole and the plate where the ankle cardan is attached. They allow to measure the vertical component of the ground reaction force and the XY position of the center of pressure. The measurement range is 2500 N, with a resolution of 10 N.

In order to recover the direction of the gravity, we also use a two-axis inclinometer, which has a 0.01 deg accuracy. Since its response time is about 300 ms, we need to mount it on a part which is motionless during a large enough time. This is why it is installed on the foot, allowing therefore to estimate the ground slope, i.e the angles of the foot with respect to the vertical. Direct kinematics can be then used to know

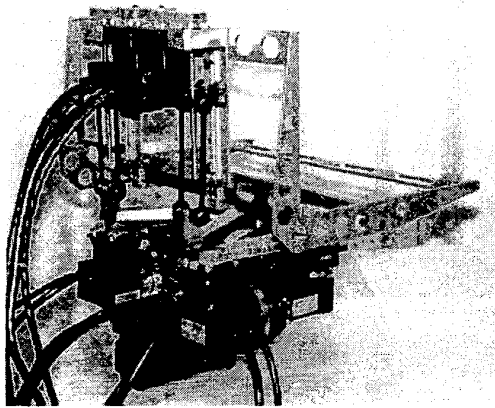

Figure 5: Parallel Actuators for the Trunk

the orientation of all other robot links w. r. to the vertical. Finally, an ultrasonic sensor with a 350-3000 mm range and a frequency of 120 khz is to be mounted on the thigh in order to reconstruct the terrain profile in front of the robot (see [5] for experimental results).

### 3.5 Control System

A main concern when designing the control structure of a biped robot like BIP2000 is to ensure its *safety* as far as possible. Such a system can be indeed qualified of *critical* in the sense that even a small failure can have strong effects leading to hard damaging of the robot. This requires to take special care of both hardware and software aspects. For the first issue, we have used classical industrial power units and chosen a VME/68040-based CPU board with high quality IP modules. A special attention has been paid to *cabling* aspects by using overqualified cables and good connectors in order to reduce electromagnetic effects. The real-time operating system is VxWorks and the control development is achieved under the ORCCAD environment (cf [6]) running on a Unix workstation. This environment allows to specify, validate and implement control laws with explicit integration of real-time aspects and handling of discrete-time events in a very efficient way. For example, owing to the use of a synchronous approach, formal verification of the resulting automata can be performed. This methodology allows to *a priori* improve the safety and the efficiency of the control implementation.

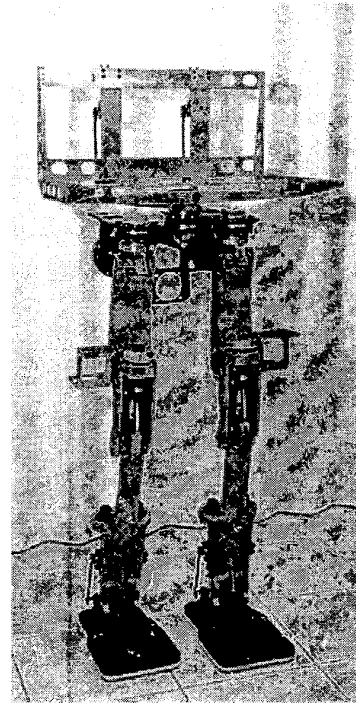

Figure 6: Skeleton of the BIP2000 Robot

## 4 Control Methods

In complement to open-loop optimization studies, two main classes of control approaches have been explored up to now: a first one is based on the task-function approach and allows to track some error functions in a given output space while controlling the motion of the center of mass. It has been tested in simulation for walking up and down stairs [9]. Animated results can be seen in <http://www.inrialpes.fr/bip/pub/walking.html>. Another approach is based on the idea that the control requirements can be splitted in two levels: first, and with the highest priority, the robot stability (in the sense of non-falling) should be ensured; then, within the remaining parametrized space of solutions, we can select the most appropriate trajectory control [7]. This also requires to take into account at each time the unilateral constraints coming from the ground/sole contact. This point, which is classically viewed through the monitoring of the ZMP, is considered with a original approach in [8].

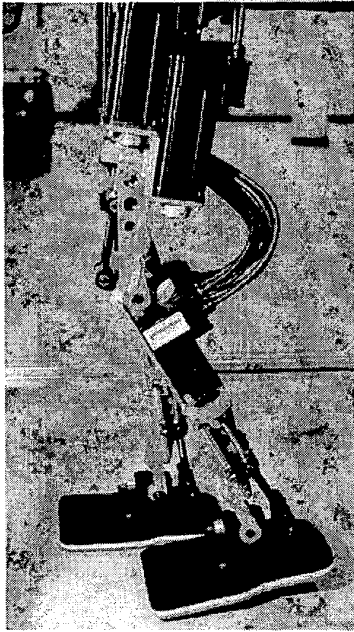

Figure 7: The Two Legs

## 5 Present State and Future Work

At the present time, two robots are mounted, one of them has a fixed pelvis, and the control units are completed. Force sensors are integrated within the feet the robot. Most of the control algorithms have been simulated for stationary walking and 3D posture modification. Low-level control functions have been implemented. More views of the robot can be found in <http://www.inrialpes.fr/bip/> and in [www.inrialpes.fr/iramr/Bipede/Etat1/bip.html](http://www.inrialpes.fr/iramr/Bipede/Etat1/bip.html).

At this stage, basic control laws runs, allowing plane walking and postural control, while the advanced control methods mentioned above are under implementation. Experimental results are presented during the Conference. In the near future, we will improve the robot by realizing new feet integrating passive joints and installing the ultrasonic sensors.

### Acknowledgments

Even though the present paper is written by two co-authors only, the reported work is the result of contributions from several researchers. We would particularly like to thank N. Andreff, C. Azevedo, G. Baille, G. Bessonnet, B. Brogliato, C. Canudas, N. Cislo, P. Di Giacomo, D.

Duquesne, A. Goswami, B. El Ali, L. France, F. Génot, H. Mathieu, P. Junqua, J. J. Parmentier, R. Pissard-Gibollet, M. Rostami, C. Sachot, T. Saidouni, E. Thomas, A. Vergnaud, P.B. Wieber and all the others...

### References

- [1] B. Espiau and the BIP Team, "BIP: A Joint Project for the Development of an Anthropomorphic Biped Robot," *Proc. Int. Conf. on Advanced Robotics*, Monterey, CA, July 1997.
- [2] P. Sardain, M. Rostami, G. Bessonnet, "An Anthropomorphic Biped Robot: Dynamic Concepts and Technological Design", *IEEE Trans. on Syst. Man and Cybernetics*, Vol 28a, no 6 pp823-838, 1998.
- [3] P. Sardain, T. Saidouni, G. Bessonnet, "Kinematic Analysis of a Parallel Mechanism Actuating the Ankle of a Biped Robot", *Proc. 10th World Congress on the Theory of Machines and Mechanisms*, Oulu, Finland, june 20-24 1999, pp141-146
- [4] K. Hirai, M. Hirose, Y. Haikawa, T. Takaneke, "The Development of Honda Humanoid Robot" *Proc. Int. Conf. on Robotics and Automation* Leuven, Belgium, 1998, pp 1321-1326
- [5] L. France, A. Girault, J.D. Gascuel, B. Espiau, "Sensor Modelling for A Walking Robot Simulation" *Eurographics Workshop on Animation and Simulation*, Milano, Italy, sept. 1999
- [6] D. Simon, B. Espiau, K. Kapellos, R. Pissard-Gibollet and the Orccad Team, "The Orccad Architecture" *Int. J. on Robotics Research*, vol 17, no 4, pp 338-359, April 1998.
- [7] P. B. Wieber, "Control Issues in Biped Walking", *EUROMECH'99*, Grenoble, France, June 30, July 1-2, 1999
- [8] F. Génot, B. Espiau, "On the Control of the Mass Center of Legged Robots under Unilateral Constraints", *CLAWAR Symp. On Climbing and Walking Robots*, Brussels, Belgium, Nov 1998.
- [9] B. El-Ali, B. Espiau, "Controlling the Center of Mass of a Biped Robot when Walking Up and Down Stairs", *Biomechanics meets Robotics Symp.*, Heidelberg, Germany, nov.1999.
- [10] J. Rose, J.G. Gamble, Eds. "Human Walking" *William & Wilkins*, Baltimore, USA, 1994