



## Faculty Publications

---

2005

### The Case for Sidney Rigdon as Author of the Lectures on Faith

Noel B. Reynolds

Brigham Young University - Provo, nbr@byu.edu

Follow this and additional works at: <https://scholarsarchive.byu.edu/facpub>



Part of the [History of Christianity Commons](#), and the [Mormon Studies Commons](#)

#### Original Publication Citation

"The Case for Sidney Rigdon as Author of the Lectures on Faith," *Journal of Mormon History*, Vol. 31 (No. 3, Fall), 2005, 1–41.

---

#### BYU ScholarsArchive Citation

Reynolds, Noel B., "The Case for Sidney Rigdon as Author of the Lectures on Faith" (2005). *Faculty Publications*. 1480.

<https://scholarsarchive.byu.edu/facpub/1480>

This Peer-Reviewed Article is brought to you for free and open access by BYU ScholarsArchive. It has been accepted for inclusion in Faculty Publications by an authorized administrator of BYU ScholarsArchive. For more information, please contact [ellen\\_amatangelo@byu.edu](mailto:ellen_amatangelo@byu.edu).

1-1-2005

## Journal of Mormon History Vol. 31, No. 2, 2005

Follow this and additional works at: <http://digitalcommons.usu.edu/mormonhistory>

---

### Recommended Citation

(2005) "Journal of Mormon History Vol. 31, No. 2, 2005," *Journal of Mormon History*: Vol. 31: Iss. 2, Article 1.  
Available at: <http://digitalcommons.usu.edu/mormonhistory/vol31/iss2/1>

This Full Issue is brought to you for free and open access by DigitalCommons@USU. It has been accepted for inclusion in Journal of Mormon History by an authorized administrator of DigitalCommons@USU. For more information, please contact [digitalcommons@usu.edu](mailto:digitalcommons@usu.edu).



---

# Journal of Mormon History Vol. 31, No. 2, 2005

## Table of Contents

### CONTENTS

#### ARTICLES

- --The Case for Sidney Rigdon as Author of the Lectures on Faith *Noel B. Reynolds, 1*
- --Reconstructing the Y-Chromosome of Joseph Smith: Genealogical Applications *Ugo A. Perego, Natalie M. Myres, and Scott R. Woodward, 42*
- --Lucy's Image: A Recently Discovered Photograph of Lucy Mack Smith *Ronald E. Romig and Lachlan Mackay, 61*
- --Eyes on "the Whole European World": Mormon Observers of the 1848 Revolutions *Craig Livingston, 78*
- --Missouri's Failed Compromise: The Creation of Caldwell County for the Mormons *Stephen C. LeSueur, 113*
- --Artois Hamilton: A Good Man in Carthage? *Susan Easton Black, 145*
- --One Masterpiece, Four Masters: Reconsidering the Authorship of the Salt Lake Tabernacle *Nathan D. Grow, 170*
- --The Salt Lake Tabernacle in the Nineteenth Century: A Glimpse of Early Mormonism *Ronald W. Walker, 198*
- --Kerstina Nilsson: A Story of the Swedish Saints *Leslie Albrecht Huber, 241*

#### REVIEWS

- John Sillito, ed., *History's Apprentice: The Diaries of B. H. Roberts, 1880-1898* *Davis Bitton, 264*
- Martha Beck, *Leaving the Saints: How I Lost the Mormons and Found My Faith* *Boyd Jay Petersen, 267*
- Donald Q. Cannon, Richard O. Cowan, et al., *Unto Every Nation: Gospel Light Reaches Every Land* *Kahlile B. Mehr, 271*
- Scott H. Faulring, Kent P. Jackson, and Robert J. Matthews, eds., *Joseph Smith's New Translation of the Bible: Original Manuscripts* *H. Michael Marquardt, 274*

# JOURNAL OF MORMON HISTORY

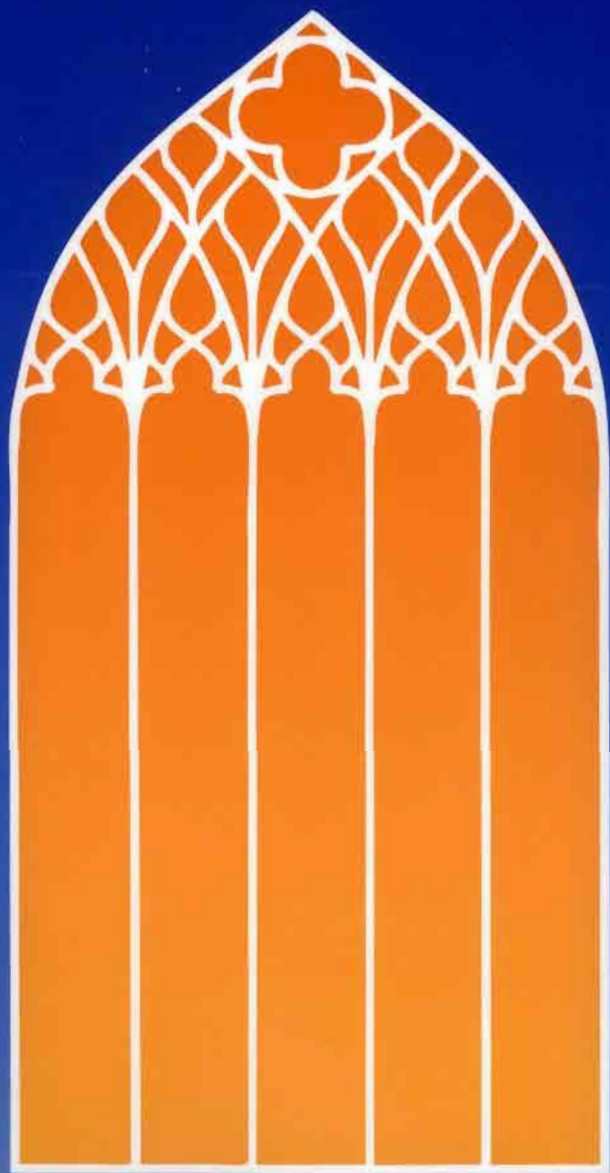

FALL 2005



# JOURNAL OF MORMON HISTORY

FALL 2005

#### **Mission Statement of the Mormon History Association**

The Mormon History Association is an independent organization dedicated to the study and understanding of all aspects of Mormon history. We welcome all who are interested in the Mormon past, irrespective of religious affiliation, academic training, or world location. We promote our goals through scholarly research, conferences, awards, and publications.

COVER: Abstraction of the window tracery, Salt Lake City Tenth Ward. Design by Warren Archer.

Articles appearing in this journal are abstracted and indexed in *Historical Abstracts* and *America: History and Life*, published by ABC-CLIO, and in *Religion Index One: Periodicals*, published by the American Theological Library Association.

© 2005 Mormon History Association  
ISSN 0194-7342

Copies of articles in this journal may be made for teaching and research purposes free of charge and without securing permission, as permitted by Sections 107 and 108 of the U.S. Copyright Law. For all other purposes, permission must be obtained from the author. The Mormon History Association assumes no responsibility for contributors' statements of fact or opinion.

## Staff of the Journal of Mormon History

*Editor:* Lavina Fielding Anderson

*Executive Committee:* Lavina Fielding Anderson, Sherilyn Cox Bennion, G. Kevin Jones, Carol Cornwall Madsen, Kahlile B. Mehr, Patricia Lyn Scott, William W. Slaughter

*Editorial Staff:* Beth Anderson, Robert Briggs, Barry C. Cleveland, Linda Wilcox DeSimone, John S. Dinger, John Hatch, Scarlett M. Lindsay, Linda Lindstrom, Craig Livingston, H. Michael Marquardt, Murphy S. Mathews, Stephen R. Moss, Jerilyn Wakefield

*Editorial Manager:* Patricia Lyn Scott

*Book Review Editor:* Tom Kimball

*Assistant Review Editor:* Linda Wilcox DeSimone

*Indexer:* Marjorie Newton

*Business Manager:* G. Kevin Jones

*Compositor:* Brent Corcoran

*Designer:* Warren Archer

### Board of Editors

*Polly Aird*, Seattle, Washington

*Douglas D. Alder*, St. George, Utah

*Gregory P. Christofferson*, Tustin, California

*Todd Compton*, Santa Monica, California

*Paul M. Edwards*, Independence, Missouri

*Gregory A. Prince*, Potomac, Maryland

*Janet Burton Seegmiller*, Southern Utah University, Cedar City, Utah

*John C. Thomas*, BYU–Idaho, Rexburg, Idaho

The *Journal of Mormon History* is published semi-annually by the Mormon History Association, 581 S. 630 East, Orem, UT 84097, 1-888-642-3678 {klarry@comcast.net}. It is distributed to members upon payment of annual dues: regular membership: \$45; joint/spouse membership: \$55; student membership: \$20; institutional membership: \$55; sustaining membership: \$125; patron membership: \$250; donor membership: \$500. For subscriptions outside the United States, please add \$10 for postage, in U.S. currency, VISA, or Mastercard. Single copies \$15 plus postage. Prices on back issues vary; contact Larry and Alene King, executive directors, at the address above.

The *Journal of Mormon History* exists to foster scholarly research and publication in the field of Mormon history. Manuscripts dealing with all aspects of Mormon history are welcome, including twentieth-century history, regional and local history, women's history, and ethnic/minorities history. First consideration will be given to those that make a strong contribution to knowledge through new interpretations and/or new information. The Board of Editors will also consider the paper's general interest, accuracy, level of interpretation, and literary quality. The *Journal* does not consider reprints or simultaneous submissions.

Papers for consideration must be submitted in triplicate, with the text typed and double-spaced, including all quotations. Authors should follow the *Chicago Manual of Style*, 15th edition (the *Journal's* style guide is available on the Mormon History Association's website {www.mhahome.org}) and be prepared to submit accepted manuscripts on computer diskette, IBM-DOS format preferred. Send manuscripts to the *Journal of Mormon History*, P.O. Box 581068, Salt Lake City, UT 84158-1068.



## CONTENTS

### ARTICLES

- The Case for Sidney Rigdon as Author of the  
*Lectures on Faith* *Noel B. Reynolds* 1
- Reconstructing the Y-Chromosome of Joseph Smith:  
Genealogical Applications *Ugo A. Perego, Natalie M. Myres,  
and Scott R. Woodward* 42
- Lucy's Image: A Recently Discovered Photograph of  
Lucy Mack Smith *Ronald E. Romig and Lachlan Mackay* 61
- Eyes on "the Whole European World": Mormon Observers  
of the 1848 Revolutions *Craig Livingston* 78
- Missouri's Failed Compromise: The Creation of  
Caldwell County for the Mormons *Stephen C. LeSueur* 113
- Artois Hamilton: A Good Man in Carthage? *Susan Easton Black* 145
- One Masterpiece, Four Masters: Reconsidering the  
Authorship of the Salt Lake Tabernacle *Nathan D. Grow* 170

The Salt Lake Tabernacle in the Nineteenth Century:  
A Glimpse of Early Mormonism *Ronald W. Walker* 198

Kerstina Nilsson: A Story of the Swedish Saints  
*Leslie Albrecht Huber* 241

### REVIEWS

John Sillito, ed., *History's Apprentice: The Diaries of  
B. H. Roberts, 1880–1898* *Davis Bitton* 264

Martha Beck, *Leaving the Saints: How I Lost the Mormons  
and Found My Faith* *Boyd Jay Petersen* 267

Donald Q. Cannon, Richard O. Cowan, et al., *Unto Every  
Nation: Gospel Light Reaches Every Land* *Kahlile B. Mehr* 271

Scott H. Faulring, Kent P. Jackson, and Robert J. Matthews, eds.,  
*Joseph Smith's New Translation of the Bible: Original Manuscripts*  
*H. Michael Marquardt* 274



# THE CASE FOR SIDNEY RIGDON AS AUTHOR OF THE *LECTURES ON FAITH*

Noel B. Reynolds

THE SECOND PUBLICATION OF Joseph Smith's revelations in 1835 bore the new title *Doctrine and Covenants* and contained significant additions to the 1833 *Book of Commandments*. Prominently placed at the beginning of this sacred collection were seven "theological lectures" derived from presentations at the "school for the Elders" in Kirtland the preceding winter.<sup>1</sup> These seven lectures were apparently conceived as the first installment in a projected "course of lec-

---

NOEL B. REYNOLDS {nbr@byu.edu} is a professor of political science at Brigham Young University. He wishes to thank the numerous colleagues who provided criticisms and suggestions on earlier drafts. Over a fifteen-year period, research assistants Scott H. Faulring, Jedediah S. Rogers, Jason Scoffield, D. Philip Kenny, Jamison Noorlander, Daniel B. McKinlay, John J. Nielsen, Adam W. Bentley, and Eden Rasmussen provided invaluable help with source materials and documentation. Alison Coutts provided equally invaluable support in doing the final formatting. This paper is derived in part from Reynolds's earlier review essay on Larry E. Dahl and Charles D. Tate Jr., *The Lectures on Faith in Historical Perspective* (Provo, Utah: BYU Religious Studies Center, 1990), 31–104, which was published in *BYU Studies* 32, no. 1 (1991): 285–94. A second version was published in the FARMS festschrift for Richard L. Anderson, "The Authorship Debate Concerning *Lectures on Faith*: Exhumation and Reburial," in *The Disciple as Witness: Essays on Latter-day Saint History and Doctrine in Honor of Richard Lloyd Anderson*, edited by Stephen D. Ricks, Donald W. Parry, and Andrew H. Hedges (Provo, Utah: FARMS, 2000), 355–82. This final version is based on the paper delivered at the 2003 MHA meetings in Kirtland as expanded by subsequent findings.

<sup>1</sup>Joseph Smith et al., *History of the Church of Jesus Christ of Latter-day Saints*, edited by B. H. Roberts, 7 vols., 2d ed. rev. (Salt Lake City: Deseret

tures designed to unfold . . . the doctrine of Jesus Christ.”<sup>2</sup> They take up the doctrine of faith as “the first principle in revealed religion and the foundation of all righteousness” (31).

There is no evidence of any effort to follow through with similar treatments of other basic gospel principles. The seven lectures were included in subsequent editions of the Doctrine and Covenants until the 1921 edition, when they were discontinued with the explanation that they were not really part of canonical LDS scripture because “they were never presented to nor accepted by the Church as being otherwise than theological lectures or lessons.”<sup>3</sup> Since 1835, these lectures have only rarely been used by scripture scholars or quoted in general conference talks. Known in their subsequently separated state as the *Lectures on Faith*, reprints of the lectures have attracted a small, but devoted following.<sup>4</sup> While there have been rumors that the *Lectures* might be resurrected for inclusion in an enhanced edition of LDS scripture, nothing has ever materialized. More recently, in 1990, BYU professors Larry E. Dahl and Charles D. Tate Jr. produced a new edition of the *Lectures*, designed to promote them and to enhance both their readability and our awareness and understanding of them.<sup>5</sup>

The 1835 title, *Doctrine and Covenants*, was actually devised to

Book, 1948 printing), 2:169–70. In late November, the school was scheduled to be held in the soon-to-be-completed printing office. The school was variously called “the school of the elders,” “the school of the prophets,” or the “Kirtland School.” I use “Kirtland School,” since that seemed to have been the term in use at the time.

<sup>2</sup>The version of *Lectures on Faith* that I reference, cited parenthetically in the text, is the Dahl and Tate edition. This quotation appears on p. 31.

<sup>3</sup>“Explanatory Introduction,” *Doctrine and Covenants* (Salt Lake City: Church of Jesus Christ of Latter-Day Saints, 1921), v. See also Charles W. Penrose, *Report of the Annual Conference of the Church of Jesus Christ of Latter-Day Saints*, April 3, 1921 (Salt Lake City: Church of Jesus Christ of Latter-Day Saints), 16 (hereafter cited as *Conference Report*).

<sup>4</sup>For the *Lectures*’ connection to the Doctrine and Covenants, see Robert J. Woodford, “Doctrine and Covenants Editions,” *Encyclopedia of Mormonism*, 4 vols. (New York: Macmillan Publishing, 1989), 1:425–27. The best publication history is Dahl and Tate, *Lectures on Faith in Historical Perspective*, 13–16 note 2.

<sup>5</sup>Dahl and Tate, *Lectures on Faith in Historical Perspective*, 13–16 note 2.

accommodate these lectures. The 1833 publication of Joseph Smith's revelations was variously referred to as the Book of Commandments, the Book of Covenants, or The Articles and Covenants of the Church, following the name of its lead section as it was circulated principally in handwritten copies. In 1835, when the lectures under the title, "On the Doctrine of the Church of the Latter Day Saints," were combined as Part One, with Joseph's revelations as Part Two under the title, "Covenants and Commandments," the resulting volume was labeled *Doctrine and Covenants* to signal the two major divisions of the contents.<sup>6</sup>

The range of reactions to the *Lectures* within the LDS community is not easy to explain. The lectures are mentioned only rarely in diaries and other sources. Joseph Smith, for example, apparently does not mention the lectures anywhere. From the beginning there appears to have been a rather general lack of interest on the part of most Church members and leaders. While it was widely believed for their first century that Sidney Rigdon was the author of the lectures, one is just as likely today to hear their contents credited to Joseph Smith. And many who do read the *Lectures* find them to be excessively "Protestant" in tone or content and to contain teachings not easily reconciled with standard LDS doctrinal understandings. One attempt to counter this perception asserts that the basic ideas of the lectures "are directly offensive to traditional or historical Christian theology" and that they served in early years "to distance Latter-day Saint theology" from Protestant and Catholic doctrines.<sup>7</sup> While this is certainly true, at least to a significant extent, it does not change the fact that the rhetoric and the formatting of the *Lectures* were borrowed from contem-

---

<sup>6</sup>Woodford, "Doctrine and Covenants Editions," 425 note 4. The older unofficial title "Book of Covenants," continued to be used in LDS discourse for some time and probably referred only to Joseph Smith's revelations in the second part of that compilation. See, e.g., Orson Hyde and William E. McLellin, Letter, *Messenger and Advocate*, October 1835, 204, quoting section 18 from "the book of covenants." A long unsigned article on Indians (by the editor John Whitmer?), explains that the "Book of Covenants, shows what a man must do, to become a fit subject for baptism."

<sup>7</sup>Joseph Fielding McConkie and Craig Ostler, *Revelations of the Restoration: A Commentary on the Doctrine and Covenants and Other Modern Revelations* (Salt Lake City: Deseret Book, 2000), 808. The authors incorporate the full text of the lectures—but not the questions and answers—in their volume.

porary Protestant discourse and that they also include some doctrinal assumptions that are most easily recognized in a Protestant context.

Indeed, this recognition played some role in the decision of the Church to abandon the *Lectures* in the 1921 reediting of the Doctrine and Covenants.<sup>8</sup> *Lectures* enthusiasts, on the other hand, have found them to be among the most sublime of all religious writings and fortified with doctrines essential to a clear grasp of the true LDS position.<sup>9</sup> The Church never chose to acknowledge this debate in any official or public way. Nor is there consensus on the standard claim that the *Lectures* as such have never been officially canonized.<sup>10</sup> Some scholars from both the LDS and the Community of Christ traditions have vigorously argued that canonization did occur.<sup>11</sup>

These differing views over the role and value of the *Lectures* in the LDS intellectual tradition were sometimes developed and expressed in terms of a debate about authorship. Advocates of the *Lectures* ascribed them to Joseph Smith, while detractors usually attributed them principally to Sidney Rigdon.<sup>12</sup> Informed opinion at the end of the nineteenth century usually held Rigdon to be the author or

<sup>8</sup>See Dahl and Tate, *Lectures on Faith in Historical Perspective*, 18.

<sup>9</sup>Several scholars insist that the doctrine of the *Lectures* came from Joseph Smith and argue that all major ideas of the *Lectures* may be found in the Prophet's pre-1834 revelations. See Hyrum Andrus, *Principles of Perfection*, Vol 2. of *Foundations of the Millennial Kingdom of Christ*, 3 vols (Salt Lake City: Bookcraft, 1968–73), 20. Prominent promoters of the *Lectures* within the LDS community include Bruce R. McConkie, Joseph Fielding Smith, and Joseph Fielding McConkie.

<sup>10</sup>McConkie and Ostler, *Revelations of the Restoration*, 808.

<sup>11</sup>For LDS scholars, see Richard S. Van Wagoner, Steven C. Walker, and Allen D. Roberts, "The 'Lectures on Faith': A Case Study in Decanonization," *Dialogue: A Journal of Mormon Thought* 20, no. 3 (Fall 1987): 71–77. For RLDS studies, see Don H. Compier, "Canonization in the Reorganized Church of Jesus Christ of Latter Day Saints," *Restoration Studies III*, edited by Maurice L. Draper (Independence: Herald Publishing House, 1986), 179. See also Harry L. Ropp, *The Mormon Papers: Are the Mormon Scriptures Reliable* (Downers Grove, Ill.: InterVarsity Press, 1977), 67–68, and Fred Collier, *Unpublished Revelations of the Prophets and Presidents of the Church of Jesus Christ of Latter-day Saints*, 2d ed. (Salt Lake City: Collier's, 1981).

<sup>12</sup>My study does not attempt a systematic assessment of the doctrinal or inspirational value of the lectures but focuses instead on the question of

the one who delivered the lectures, while recognizing that Joseph Smith may have been involved in preparing the final version for publication. The *Deseret News*, in a 1902 article presumably written by its editor, Charles W. Penrose, states without qualification that the lectures were “delivered by Sidney Rigdon, but they were subsequently examined and prepared for publication in the Doctrine and Covenants by the Prophet Joseph Smith.”<sup>13</sup> The histories written about the compilation of revelations in the Kirtland period sometimes emphasize multiple authorship, even including Oliver Cowdery, Hyrum Smith, and Frederick G. Williams.<sup>14</sup> No one has as yet produced solid historical evidence from 1834–35 to establish or refute any particular theory. The 1990 Dahl and Tate volume on the *Lectures* presents historical background that seriously understates the evidence for Rigdon’s leading role, and most contributors to that volume assumed Joseph

---

authorship.

<sup>13</sup>In the early 1920s, Penrose again wrote that the lectures “were delivered by Sidney Rigdon” when he was in full fellowship. Leland H. Gentry, “What of the Lectures on Faith,” *BYU Studies* 19, no. 1 (Fall 1978): 14, quoting “The Lectures on Faith,” *Deseret Evening News*, November 8, 1902, 4.

<sup>14</sup>H. S. Salisbury, “History of Education in the Church of Jesus Christ of Latter Day Saints,” *Journal of History*, 18 vols. (Lamoni, Iowa/Independence: Board of Publication of the Reorganized Church of Jesus Christ of Latter-day Saints, 1908–25): Vol. 15, no. 3 (July 1922): 262–69; H. Michael Marquardt, *The Joseph Smith Revelations: Text and Commentary* (Salt Lake City: Signature Books, 1999), 15–16; Kurt Widmer, *Mormonism and the Nature of God: A Theological Evolution, 1830–1915* (Jefferson, N.C.: McFarland, 2000), 61; Milton V. Backman Jr., *The Heavens Resound: A History of the Latter-day Saints in Ohio, 1830–1838* (Salt Lake City: Deseret Book, 1983), 269; and John Henry Evans, *Joseph Smith: An American Prophet* (New York: Macmillan, 1933), 96. McConkie and Ostler, *Revelations of the Restoration*, 808, tend to cite Joseph Smith when they quote the lectures but accept the possible involvement of others in their composition. After a cursory review of the history, they conclude: “Let it suffice to say that the doctrinal ideas found in the lectures trace back to Joseph Smith; others helped in their expression; the final approval of all that was written rested with him.” On the contrary, I will document in this article that the “final approval” many writers assume Joseph Smith gave to the *Lectures* and the other contents of the 1835 edition of the Doctrine and Covenants has almost no basis in the historical record and looks dubious in the face of a number of facts not previously examined in this connection.



Smith's authorship as unquestioned fact. A 1994 biography of Sidney Rigdon introduces no original research on this question, but refers matter of factly to "Rigdon's preparation and delivery of a seven-part series of theological lectures . . . during the 1834–35 winter term of the School of the Elders."<sup>15</sup>

While many have written previously on this problem, this paper presents the results of the first comprehensive survey of the available evidence, much of which has not been previously examined for its relevance to this issue. While historians will probably agree that most of the documentary evidence has been inconclusive, this paper will introduce new evidence that I argue solidifies the case for Sidney Rigdon's authorship of the *Lectures on Faith*. But first, I will review all the previously identified evidence that could reasonably bear on the conclusion, even when it may be inconclusive. A strong solution must fit and make sense when juxtaposed with all the potentially relevant evidence.

#### THE AUTHORSHIP ISSUE

Several writers have found much in the *Lectures* and in the Church's eventual separation of them from the scriptural canon with which to embarrass Latter-day Saints.<sup>16</sup> Insisting that Joseph was responsible for the *Lectures* apparently made their task easier. For example, Dan Vogel uses Lecture 5 as his principal evidence for an evolving Mormon concept of God that in 1835 reflected "Sidney Rigdon's Primitivistic background and not the [later] orthodox LDS view of three distinct personages in the godhead."<sup>17</sup> Other commentators cite this same issue as a reason for removing the *Lec-*

---

<sup>15</sup>Richard S. Van Wagoner, *Sidney Rigdon: A Portrait of Religious Excess* (Salt Lake City: Signature Books, 1994), 161. He cites a supportive selection of the existing secondary material on the authorship question (174 note 6).

<sup>16</sup>See, e.g., Jerald and Sandra Tanner, *Mormonism—Shadow or Reality* (Salt Lake City: Utah Lighthouse Ministry, 1987), 166–67.

<sup>17</sup>Dan Vogel, "The Earliest Mormon Concept of God," in *Line upon Line: Essays on Mormon Doctrine*, edited by Gary James Bergera (Salt Lake City: Signature Books), 1989, 27–29. Other essays in the Bergera volume make the same points. See, e.g., Thomas G. Alexander, "The Reconstruction of Mormon Doctrine," 54–56: "The position of the LDS church between 1830–1835 was probably closest to that of the Disciples of Christ and the Methodists, although differences existed" (56); and Vern G. Swanson,

tures from the canon in 1921.<sup>18</sup>

Opinions on the authorship and status of the *Lectures* in LDS literature have varied widely among both scholars and church authorities. Some have ascribed the doctrinal incompleteness of the *Lectures* to the rapid doctrinal development going on during the mid-1830s.<sup>19</sup> Others argued against the idea that the Prophet's understanding of the nature of the godhead was evolving through this period.<sup>20</sup> Joseph McConkie and Craig Ostler claim that the *Lectures* were aimed to "distance Latter-day Saint theology from doctrines rooted in either Protestantism or Catholicism" and that "each of the lectures centers on one or more basic ideas that are directly offensive to traditional or historical Christian theology." They also called the *Lectures* "a most instructive document, and, in the judgment of the writers, those few matters viewed by some as stumbling stones become, when polished by a thoughtful second or third look, rather bright and precious gems of truth."<sup>21</sup> Elders Bruce R. McConkie and Joseph Fielding Smith both thought Joseph Smith was the author of the *Lectures* and defended them vigorously on various occasions.<sup>22</sup> We may never know the extent to which Joseph Fielding Smith may have argued for reten-

---

"The Development of the Concept of a Holy Ghost in Mormon Theology," which credits the continuing inclusion of the *Lectures* in the Doctrine and Covenants for "the longevity of the idea that the Holy Ghost was not a personage" in LDS doctrinal teaching and writing (89–94). Marvin S. Hill, *Quest for Refuge: The Mormon Flight from American Pluralism* (Salt Lake City: Signature Books, 1989), 49, referring to the same issues, says, "It was during this same period [1835] that the Mormon doctrine of deity began to take on a distinctive shape."

<sup>18</sup>Widmer, *Mormonism and the Nature of God*, 61, 64, 153, holds that the *Lectures* were canonized but the Church had to remove them from the Doctrine and Covenants because the Mormon view of God had changed. Van Wagoner, Walker, and Roberts make the same point in "The 'Lectures on Faith': A Case Study in Decanonization."

<sup>19</sup>See T. Edgar Lyon, *Introduction to the Doctrine & Covenants and the Pearl of Great Price* (Salt Lake City: LDS Department of Education, 1948), 33–35; Penrose made the same point in *Conference Report*, April 3, 1921, 16.

<sup>20</sup>Joseph Fielding McConkie and Robert L. Millet, *Joseph Smith, the Choice Seer* (Salt Lake City: Bookcraft, 1996), 26.

<sup>21</sup>McConkie and Ostler, *Revelations of the Restoration*, 808–9.

<sup>22</sup>See Bruce R. McConkie, "The Lord God of Joseph Smith," *Speeches*

tion of the *Lectures* in 1921 as a member of the committee that proposed their 1921 removal. But the committee, which also included senior apostles George F. Richards, Anthony W. Ivins, Melvin J. Ballard, James E. Talmage, and John A. Widtsoe, made the recommendation and the presiding quorums of the Church approved that action soon thereafter. Not much official explanation was given for this change beyond the clarification that these lectures were not scripture but merely “helps.”<sup>23</sup> At least some of the presiding brethren possibly held Widtsoe’s view, published later, that they were “written by Sidney Rigdon and others.”<sup>24</sup> Three independent authorship studies conducted in recent decades, using different reputable techniques, all conclude that Sidney Rigdon was the primary author of the *Lectures*. According to these studies, not a single lecture can be confidently attributed to Joseph Smith.

#### AUTHORSHIP STUDIES

The first authorship study on the *Lectures* was done at the request of the LDS Church’s Historical Department in 1976. Elinore H. Partridge performed a traditional qualitative stylistic analysis on Joseph Smith’s holographic writings, identified a set of clear differences between the writing styles of Joseph Smith and Sidney Rigdon, and applied the results to the *Lectures*. While she found possible influences of Joseph Smith in the images, examples, scriptural references, and phrasing of the *Lectures*, she was “quite certain that Joseph Smith neither wrote nor dictated the major portion of the lectures.”<sup>25</sup> She added that some passages reminded her of Oliver Cowdery’s argumentative style, while other passages and features of the *Lectures* did not seem to fit any of the potential authors she had considered. Unfortunately, she had not extended her analysis to include contempo-

---

*of the Year, 1971–72* (Provo, Utah: Brigham Young University, 1972), 4, and Joseph Fielding Smith, *Seek Ye Earnestly* (Salt Lake City: Deseret Book, 1970), 194.

<sup>23</sup>Gentry, “What of the Lectures on Faith,” 11.

<sup>24</sup>John A. Widtsoe, *The Message of the Doctrine and Covenants* (Salt Lake City: Bookcraft, 1969), 2.

<sup>25</sup>Elinore H. Partridge, “Characteristics of Joseph Smith’s Style and Notes on the Authorship of the Lectures on Faith,” *Task Papers in LDS History Series*, no. 14 (Salt Lake City: LDS Church History Division, Church of Jesus Christ of Latter-day Saints, 1976), 28, 25.

rary Protestant lectures of this same type that might have provided stylistic elements possibly borrowed by the Kirtland lecturers. While she found Sidney Rigdon's style dominant throughout most of the seven lectures and thought he most likely prepared them for publication, she warned that the style was not consistently his throughout.<sup>26</sup>

At about the same time, Alan J. Phipps was writing a master's thesis at Brigham Young University on the *Lectures's* authorship.<sup>27</sup> He used the quantitative technique of counting "function words" in the writings of several author-candidates, then compared their frequency ratios with frequencies in the seven lectures, one at a time. He concluded that, of the possible authors considered, the function-word frequency of the *Lectures* as a whole most nearly matched the writings of Sidney Rigdon. In spite of the brevity of the individual lectures, he used the same technique to assess the authorship of each. Again, Rigdon emerged as the likely author, except for Lecture 5, which more closely matched Joseph Smith's writings. Lectures 2, 3, 4, and 6 were not as clearly distinguishable as 1, 5, and 7.

One needs to be very cautious about giving too much weight to such a study for two reasons. First, not enough statistical studies on function-word frequencies have been performed to establish the reliability of this method nor are there base statistical measures that would identify how much of a difference is necessary to constitute significance. Phipps had to rely on his own intuition and common sense for these guidelines. Second, the lectures are individually quite short, offering only small textual samples; the shortest, Lecture 5, is 744 words, while Lecture 7 is 2,929 words long. Small samples are the bane of statisticians and cannot ordinarily be used to draw strong conclusions. Phipps also attempted some other tests, but problems of sample size make those findings even less compelling, especially since he applied them to individual paragraphs in an attempt to sort out editorial additions.

Similar cautions apply to the 1980 study by Wayne Larsen and Alvin Rencher. However, these professional statisticians were well aware of such issues and took appropriate precautions in selecting analytical techniques that could work for such small texts. Larsen and Rencher extended their massive statistical study of noncontextual

---

<sup>26</sup>*Ibid.*, 28.

<sup>27</sup>Alan J. Phipps, "The Lectures on Faith: An Authorship Study" (M.A. thesis, Brigham Young University, 1977).

word frequencies in the text of the Book of Mormon—which first established scientifically the independent authorship of the different sections of that book—to include the *Lectures on Faith*.<sup>28</sup> One reason for doing this was that their statistical techniques were different and far more powerful than those used by Phipps, and they also had a stronger set of comparison texts to work from. Still, their findings generally confirmed those of Phipps. They were virtually positive that Rigdon had authored all lectures except possibly 2 and 5. Lecture 2, it should be noted, consists principally of materials quoted from the Bible and the *Joseph Smith Translation*. Such quotations are not easily accommodated in these kinds of studies. Larsen and Rencher would attribute Lecture 5 to William Phelps or even Parley P. Pratt. But those statistical correlations are much weaker. Lecture 2 statistics were also weak and favored Joseph Smith, with Sidney Rigdon a close second choice.

In sum, the formal authorship studies conducted on the *Lectures on Faith* all favor Sidney Rigdon as author or principal author in a group effort. When considered individually, Lecture 5 was consistently problematic and was linked tentatively to W. W. Phelps, Parley P. Pratt, or Joseph Smith. This uncertainty is to be expected because Lecture 5 is so much shorter than any of the other six and provides little data for analysis. While these studies each have their own limitations, and none should be relied on alone for strong conclusions, the fact that three different studies using completely different assumptions and approaches reached the same general conclusion does provide support for the Rigdon thesis. Furthermore, the historical and circumstantial evidence leans the same way.

Two pre-1950 writers looked at this issue and reached similar conclusions. Joseph White found Rigdon's influence everywhere in early theological matters and noted that Rigdon, as a Mormon, retained the same phraseology he had used earlier as a Campbellite.<sup>29</sup> Historian John Henry Evans observed:

---

<sup>28</sup>Wayne A. Larsen and Alvin C. Rencher, "Who Wrote the Book of Mormon? An Analysis of Wordprints," *BYU Studies* 20, no. 3 (Spring 1980): 249, Appendix E: "The Lectures on Faith"; revised and reprinted most recently in *Book of Mormon Authorship*, edited by Noel B. Reynolds (Provo, Utah: FARMS, 1996), 183–84.

<sup>29</sup>Joseph Welles White, "The Influence of Sidney Rigdon upon the

It is illuminating to contrast the ideas and method of Joseph Smith with those of Sidney Rigdon as brought out in their discussions of theological questions at this school. A course of lectures was given here by Elder Rigdon. . . . A thoroughly commonplace treatise, it was as unlike anything Joseph Smith ever wrote as was Ralph Waldo Emerson's writing different from that of his contemporary, Margaret Fuller. "Uninspired" is the only word that properly describes the pamphlet. It begins with a definition taken from Buck's dictionary, proceeds to tell us how our knowledge of God is derived, and goes on to describe the qualities of God as shown in the Bible. The treatment is just what any one of a thousand theologians of Rigdon's time could produce. It is said that Oliver Cowdery also aided in the composition of this document.<sup>30</sup>

### THE HISTORICAL EVIDENCE

Our ability to penetrate and understand the proceedings of the December 1834 Kirtland School is severely hampered by the scarcity of clarifying contemporary statements about the lectures or their authors. The few direct statements from participants that appear to have survived include a relatively contemporary journal entry by Heber C. Kimball and an interview with Zebedee Coltrin published almost fifty years later in Salt Lake City. Three other published reminiscences are also from these later periods. Kimball referred to the "Theological School" held during the winter of 1834-35, in which the *Lectures on Faith* were given. While it is usually assumed that the lectures were delivered before the opening of the grammar school on December 22, 1834, "under the superintendence of Sidney Rigdon and William E. McLellin teachers," the record is far from clear on this matter. In late December McLellin describes a school that was already devoted to "the sciences of penmanship, arithmetic, English grammar and geography," but Rigdon stated in 1845 that lectures were "delivered before a theological class in Kirtland Ohio in the winter of

---

Theology of Mormonism" (M.A. thesis, University of Southern California, 1947). Later studies do not support White's main contention that "the Mormons varied from the Disciples [of Christ] in just the ways that Rigdon varied" (135) and that therefore Rigdon was the real source of Mormon theology.

<sup>30</sup>John Henry Evans, *Joseph Smith: An American Prophet* (New York: Macmillan, 1933), 95-96.

1834–1835.”<sup>31</sup>

Nor does it seem likely that the relatively brief and rhetorically homogenous lectures published in the Doctrine and Covenants are transcriptions of all the teachings on faith given at the school. The Kimball journal provides helpful details of how “a certain number were appointed to speak at each meeting.” On the day appointed for his turn, he followed others who were also assigned to speak on faith and who “quoted every passage mentioned in the scriptures on the subject.” He records how he retold a family incident illustrating his daughter’s faith that reduced the Prophet to tears.<sup>32</sup> Zebedee Coltrin also remembered that the elders’ meeting that heard the *Lectures on Faith* met in a school “where Sidney [Rigdon] presided.”<sup>33</sup> Another member of the school, Harrison Burgess, wrote that he attended “high school” with Joseph Smith, Hyrum Smith, and most of the leading men of the Church. “It was then and there

---

<sup>31</sup>McLellin explained that the grammar school was too popular, and had to be trimmed from 130 in the third week, to seventy of the older students. W. E. McLellin, Letter to the editor, February 27, 1835, *Messenger and Advocate* 1, no. 5 (February 1835): 80, states that he had been an instructor in the school “from its commencement in Dec.—last.” See also Larry E. Dahl, “Authorship and History of the Lectures on Faith,” in Dahl and Tate, *Lectures on Faith in Historical Perspective*, 21.

<sup>32</sup>Journal History, December 22, 1834, in *Selected Collections from the Archives of the Church of Jesus Christ of Latter-day Saints*, 2 vols., DVD (Provo, Utah: Brigham Young University Press, [Dec. 2002], Vol. 1, disk 1, vol. 6 of Journal History (December 9-31, 1834), image 14. The classroom procedures described here closely match those in use by the frontier sensation, Rev. Charles G. Finney, as described in the opening paragraph of the preface to his published lecture outlines. See his *Skeletons of a Course of Theological Lectures* (Oberlin, Ohio: Steele, 1840), 3. Finney’s volume is more readily available under the altered title used for its 1968 photographic reprint. See Charles G. Finney, *Finney’s Lectures on Theology* (Minneapolis, Minn.: Bethany Fellowship, 1968).

<sup>33</sup>“Salt Lake School of the Prophets Minute Book,” 1883, holograph, 69. Dahl reinterprets these references to Rigdon’s presiding role on the assumption that Joseph must have presided if he were present (2–13). While this assumption would clearly be justified in a twentieth-century context, leadership norms in the Kirtland period were not so clearly established. For example, *Kirtland Council Minute Book (1832–1837)*, edited by Fred C. Collier and William S. Harwell (Salt Lake City: Collier’s Publishing, 2002), 81,

that the Lectures in the first part of the book of the *Doctrine and Covenants* were given.<sup>34</sup> Another participant, Benjamin F. Johnson, reported that most of the first elders of the Church attended this School of the Elders.<sup>35</sup> Jedediah M. Grant also confirms that “Elders Smith, Rigdon, and others, acted as teachers” for the school.<sup>36</sup> The contemporary account in the *Messenger and Advocate* indicated that the Kirtland School had been conducted under “the immediate care and inspection of Joseph Smith, Frederick Williams, Sidney Rigdon, and Oliver Cowdery.”<sup>37</sup>

The *History of the Church* appears to have a few helpful entries. But since they were interpolated by later secretaries, not drawn from original records like the Prophet’s journals, they cannot be used to establish the Prophet’s authorship of the *Lectures*. Furthermore, only one appears to link Joseph Smith directly to the content of the *Lec-*

---

records a meeting at which Rigdon presided even though Joseph Smith was present. The minutes of a meeting on December 28, 1834 (the same time that the school was meeting) state: “the counsellors then made their remarks and also Presidents F. G. Williams & J. Smith Junr. after which President Rigdon gave decision.” Kirtland High Council minutes for September 28 and October 3, 1835, each record that the presiding presidents were Oliver Cowdery, Hyrum Smith, and John Whitmer, even though Joseph Smith was present on both occasions. From examples like these, D. Michael Quinn, *The Mormon Hierarchy: Origins of Power* (Salt Lake City: Signature Books, 1994), 8, emphasized the “egalitarian nature of the church before 1835.” By 1835 there were nine “presidents of the Church” who somehow shared conducting and presiding duties. The First Presidency as we now know it, with its unique responsibilities, structure, and authority did not emerge as a formal office until 1838.

<sup>34</sup>Harrison Burgess, “Sketch of a Well-Spent Life,” in *Labors in the Vineyard* (Salt Lake City: Juvenile Instructor’s Office, 1884). Burgess dates this episode as the winter of 1836; but since he specifies that it was the winter after his return from Zion’s Camp, it is clear that he misdated it. Zion’s Camp took place in May and June of 1834.

<sup>35</sup>Benjamin F. Johnson, *My Life’s Review* (Independence: Zion’s Printing and Publishing, 1947), 21–22.

<sup>36</sup>Jedediah M. Grant, *A Collection of Facts, Relative to the Course Taken by Elder Sidney Rigdon, in the States of Ohio, Missouri, Illinois and Pennsylvania* (Philadelphia: Brown, Bicking & Guilbert, 1844), 8–9.

<sup>37</sup>McLellin, Letter to the editor, 80.



tures: "During the month of January [1835], I was engaged in the school of the Elders, and in preparing the lectures on theology for publication in the book of *Doctrine and Covenants*, which the committee appointed last September were now compiling."<sup>38</sup> Such a statement falls short of constituting acceptable historical evidence that Joseph was responsible for their content or method. Yet it appears to be the principal basis of the recurring assertion that Joseph Smith was an author of the *Lectures*. If Rigdon is the main author, how can we know if Joseph's review was light or heavy? Anyone who has revised materials written by a close and possibly sensitive associate knows what a complex task that can be.

But the statement itself may not reflect Joseph Smith's own words at all. His original diaries and journals, which for some periods provided most of the source material from which the *History of the Church* was later compiled, have a fifteen-month gap which spans the period in which the lectures were delivered and prepared for publication. Consequently, we can never know from Joseph Smith's own records whether he was heavily involved. Willard Richards inserted the quotation above into the record eight years after the fact; his journal for August 28, 1843, indicates which pages of the manuscript history he worked on that day.<sup>39</sup> It cannot be determined whether Richards's insertion was suggested by Joseph Smith or whether he was making his own best guess to fill a gap. Other records establish Joseph's presence in Nauvoo that day,<sup>40</sup> but Richards seems to have been working largely alone during this period. Consequently, the most reasonable assumption is that Richards may have had some factual basis, not now available to us, for this January entry. But the language is unfortunately too vague to help us assess the level of Joseph Smith's contribution to the composition, or even the publication of the lectures.

Similarly, claims that the Kirtland general assembly held on August 17, 1835, accepted the theological lectures as the "doctrine of

---

<sup>38</sup>*History of the Church* 2:180.

<sup>39</sup>Compare Willard Richards, Journal, August 28, 1843, with the Manuscript History of the Church, Book B-1, 563, both LDS Church Archives. The Richards diary is in *Selected Collections*, on Vol. 1, disk 31, image 8; the Manuscript History for 1843 is in Vol. 1, disk 2.

<sup>40</sup>See Scott H. Faulring, ed., *An American Prophet's Record: The Diaries and Journals of Joseph Smith* (Salt Lake City: Signature Books, 1989), 411.

the Church” and that the Prophet “wholly approved” them overstate the documented facts.<sup>41</sup> In fact, the published minutes of this conference, that approved publication of the new Doctrine and Covenants, only identify Joseph’s revelations as church doctrine and the lectures as “judiciously arranged and compiled, and profitable for doctrine.”<sup>42</sup> But even this weaker claim is a later editorial expansion of the original record of the conference.<sup>43</sup> The *Kirtland Council Minute Book* reports President John Smith’s response, principally in terms of his personal experiences of being present when some of the revelations were given, and his joy in finally receiving “the long wished for document to govern the church in righteousness and bring the elders to see eye to eye.”<sup>44</sup> The expanded account that was published only weeks later in the *Messenger and Advocate* and also in the Doctrine and Covenants may indeed have correctly reported John Smith’s further comments referring explicitly to the *Lectures*, but these statements do not appear in the brief summary of his comments in the original record. John Smith was speaking as the president of the Kirtland High Council, the body that on September 24, 1834, had appointed a four-man committee to prepare a new edition of Joseph’s revelations for publication.<sup>45</sup> Of the four members of the First Presidency (who also constituted this committee), only Oliver Cowdery and Sidney Rigdon were present for the August 17, 1835, assembly. The minutes record the absence of the other two members of the First Presidency—Joseph Smith and Frederick G. Williams. None of the twelve apostles was present either. All three members of the committee that compiled the 1833 Book of Commandments—John Whitmer, Oliver Cowdery, and W. W. Phelps—were present.<sup>46</sup> In retrospect, it seems a rather curious conference that proceeds without the president or any apostles in attendance.

---

<sup>41</sup>Robert L. Millet, “The Supreme Power over All Things: The Doctrine of the Godhead in the Lectures on Faith,” in Dahl and Tate, *Lectures on Faith in Historical Perspective*, 238–39.

<sup>42</sup>*History of the Church* 2:243–44.

<sup>43</sup>Compare *History of the Church* 2:243–44 with *Kirtland Council Minute Book*, 98–106, also available in *Selected Collections*, 1:19.

<sup>44</sup>As quoted in *Kirtland Council Minute Book*, 103.

<sup>45</sup>*Ibid.*, 74–76.

<sup>46</sup>See Joseph Smith, *Book of Commandments and Book of Doctrine & Covenants* (Independence: Reorganized Church of Jesus Christ of Latter Day

The longer account in the Kirtland Council Minute Book summarizes the comments made by each quorum or other group as they registered their vote on the newly printed book, combining the *Lectures* with the revelations to Joseph Smith. Apparently, Oliver Cowdery presented a set of page proofs or an unbound copy<sup>47</sup> as “the Book” which was passed from one president to the next as they stood in turn to announce their quorum votes. While most of the comments referred to the revelations and to personal experiences of being present when the revelations were received, two men referred to the lectures, which had been partially published in the *Messenger and Advocate*, including them in their testimonies of the truthfulness of the new book. Bishop Newel K. Whitney referred to both parts of the proposed volume: He had examined the lectures contained in the book, “believed them beyond a doubt,” and affirmed that “the revelations contained in it . . . were true.”<sup>48</sup> Similarly, President Leonard Rich, appointed to speak for the Seventy, took the book in his turn, “and said that he had examined the Lectures and many of the Revelations contained in it, and was perfectly satisfied with the same, and further, that he knew that they were true by the testimony of the Holy Spirit of God given unto him.”<sup>49</sup> The comments of most others focused their testimonies on the revelations or the Book of Mormon, without any clear suggestion that they had actually read the new book, or even a major portion of it. Neither the original minutes, nor the revised ver-

---

Saints, 1920), 7-8.

<sup>47</sup>The Doctrine and Covenants was at press by June 1835. See Peter Crawley, “A Bibliography of the Church of Jesus Christ of Latter-day Saints in New York, Ohio, and Missouri,” *BYU Studies* 12, no. 4 (Summer 1972): 499. Bruce A. Van Orden, “W. W. Phelps: His Ohio Contributions, 1835-36,” in *Regional Studies in Latter-day Saint History: Ohio*, edited by Milton V. Backman Jr. (Provo, Utah: BYU Department of Church History and Doctrine), 48-49, wrote: “In June 1835 W. W. Phelps directed the setting of the type for printing the Doctrine and Covenants in Kirtland. By early August the printing was completed, and the pages were sent to Cleveland for binding.” This chronology should be qualified in light of the August meeting at which the articles on marriage and government were not included in the unbound version shown that day, but which were read to the assembly and then approved for printing and binding with the rest of the book.

<sup>48</sup>*Kirtland Council Minute Book*, 104.

<sup>49</sup>*Ibid.*

sions published later suggest divided opinion on the new book. The vote on it and on the two additional articles on government and marriage were all carried unanimously.

There might be stronger warrant for attributing the *Lectures* to Joseph Smith if we could reasonably project present-day Church decision-making processes back to 1834–35 without anachronism. It is not likely that counselors in a contemporary First Presidency would announce statements of doctrine which the president did not fully endorse. But the Church has matured a great deal since 1835. The internal dynamics of First Presidencies today exhibit a unity of purpose and approach and a deference for the president that Joseph Smith may have dreamed of but appears never to have enjoyed. At this time, Joseph's preeminent role as president was not as clearly established in day-to-day relationships as it was in the revelations. And all the key actors in this particular episode openly turned against Joseph and left the Church within a few years. In the very month of the Kirtland School, Oliver referred in print to Joseph Smith merely as "one of the presidents of this church," not making any distinction between them.<sup>50</sup>

That both Cowdery and Rigdon tried to elevate their own positions in the kingdom (specifically vis-à-vis Joseph) is a matter of historical record. As early as 1830, Joseph had found it necessary to rebuke Oliver for his attempts to revise the revelations: ". . . by what authority he [Cowdery] took upon him to command me [Smith] to alter, or erase, to add or diminish to or from a revelation or commandment

---

<sup>50</sup>"Letter III," *Messenger and Advocate*, December 1834, 42. While historians have noted that some earlier converts were offended and jealous when Joseph brought the new convert, Sidney Rigdon, immediately to the highest level of church authority, we should remember how critical Rigdon's successful proselyting among the memberships of his thirteen congregations of Disciples in the larger Kirtland area had been to the positive reception and growth of the newly gathered church in the early Kirtland period. Joseph was very taken with Sidney's great knowledge of the Bible, his speaking ability, and the obvious fact that he had unwittingly been inspired to prepare the way for the Kirtland gathering during his years as a Campbellite minister in that area. See, e.g., Richard L. Bushman, *Joseph Smith and the Beginnings of Mormonism* (Urbana: University of Illinois Press, 1984), 174–75.

from Almighty God.”<sup>51</sup> The official clarification that Joseph was the head and not to be commanded by Oliver had come in a September 1830 revelation.<sup>52</sup> In a famous 1832 incident recorded by Reynolds Cahoon, Rigdon had seized on a prolonged absence of Joseph to announce that he had received a new revelation claiming “that the Kingdom was taken from the Church and left with him.”<sup>53</sup> After the martyrdom in Pittsburgh, Rigdon claimed that he and Frederick G. Williams as counselors had been equal with Joseph as holders of the keys of the kingdom.<sup>54</sup>

For the same 1835 edition of the Doctrine and Covenants in which the theological lectures were first published, we have clear evidence of other significant materials being included in the face of explicit, repeated requests from Joseph Smith to leave them out. In 1869, Apostle Joseph F. Smith recorded a statement by Brigham Young that Oliver Cowdery had included the statement on marriage in the 1835 edition of the Doctrine and Covenants despite Joseph’s repeated requests that it not be included.<sup>55</sup> Nine years later, Joseph F. Smith expanded on this point in a public meeting suggesting that Oliver Cowdery had written the section on marriage for personal reasons and that it was included in the Doctrine and Covenants “without authority.”<sup>56</sup> Joseph Fielding Smith may not have been aware of his father’s statements when he wrote in 1953 that Jo-

<sup>51</sup>Dean Jessee, *Papers of Joseph Smith*, 1:260, 320; Marquardt, *The Joseph Smith Revelations*, 18.

<sup>52</sup>D&C 28:1–7. See also D&C 30:7, 43:1–7. See the expanded account in Van Wagoner, *Sidney Rigdon*, 126–28.

<sup>53</sup>D. Michael Quinn, *The Mormon Hierarchy: Origins of Power* (Salt Lake City: Signature Books, 1994), 42.

<sup>54</sup>Marvin S. Hill, *The Quest for Refuge: The Mormon Flight from American Pluralism* (Salt Lake City: Signature Books, 1989), 158–59.

<sup>55</sup>“Prest. [Brigham] Young spoke 12 minutes in relation to Sec. 109 B[ook] of *Doctrine and Covenants* [“Article on Marriage”]. Saying Oliver Cowdery wrote it, and inscisted on its being incerted in the Book of D. & C. contrary to the thrice expressed wish and refusal of the Prophet Jos. Smith.” Joseph F. Smith, Diary, October 9, 1869, holograph, LDS Church Archives, in *Selected Collections from the Archives of the Church of Jesus Christ of Latter-day Saints*, 2 vols., DVD (Provo, Utah: Brigham Young University Press, [Dec. 2002], Vol. 1, disk 26, image 18.

<sup>56</sup>Joseph F. Smith, July 7, 1878, *Journal of Discourses* 26 vols. (London

seph Smith knew nothing of the articles on government and marriage. Regarding the September 17, 1835, conference, Joseph Fielding Smith also believed it “was unfortunate that the guiding hand of the Prophet was not there at this conference. We may feel assured that some things were considered and passed upon that would not have been entertained had he been present.” However, he also specifically exempted the *Lectures*, claiming that they were presented (delivered) “under the guiding hand of the Prophet Joseph Smith.”<sup>57</sup>

The fact that Joseph Smith’s printed name leads the list of signatories to the prefatory letter prepared six months earlier for that volume has led most readers to conclude that he at least endorsed the *Lectures*. But all we know for sure, as the letter of preface clearly recognizes, is that these are the four names that the Kirtland High Council had assigned to do this work a year earlier. In terms of the decision-making process on the composition and publication of the *Lectures on Faith*, the only clearly documented role that Joseph Smith played (beyond his formal membership on the committee) was his attendance at the 1834–35 School of the Elders. Frederick G. Williams, the fourth signatory, was apparently involved principally as the printer and not as a contributor.<sup>58</sup> Given the historical record, it is perfectly possible that Joseph’s role was limited to the preparation of his own revelations, which constituted the bulk of that volume. The most obvious procedure for that committee would have been to let each member focus on preparing his own contributions to the larger volume, with editorial assistance from Oliver Cowdery. If that were their procedure, it would also make sense for each of them to be signatories to the prefatory letter, even though we have such clear evidence that Joseph wanted some of the materials not to be included.

But there is even some evidence that Rigdon and

---

and Liverpool: LDS Booksellers Depot, 1855-86), 20:29. I thank Paul Hoskisson for this reference.

<sup>57</sup>Joseph Fielding Smith, *Church History and Modern Revelation*, vol. 2 (Salt Lake City: Council of the Twelve Apostles of the Church of Jesus Christ of Latter-day Saints, 1953), 30, 29, 33.

<sup>58</sup>The title page lists Williams as one of the four “Presiding Elders of the Church.” It also indicates that this new volume was “printed by F. G. Williams & Co.” See *History of the Church* 2:250.

Cowdery—rather than Joseph Smith—were the principal authors of the changes in the revelations that appeared in the 1835 edition. For example, it now seems likely that Oliver Cowdery wrote the three-verse introduction to section 89, which was not part of the original revelation.<sup>59</sup> Earlier, in preparation for the 1833 edition, Joseph Smith had charged W. W. Phelps, Oliver Cowdery, and John Whitmer “to review the Book of Commandments and select for printing such as shall be deemed by them proper, as dictated by the spirit.”<sup>60</sup> Richard O. Cowan suggests that this assignment launched a process of selection and revision that explains why certain revelations were excluded or included in the printings of the Doctrine and Covenants.<sup>61</sup> Much earlier, Joseph Smith had warned W. W. Phelps not to change the language of the revelations when he was preparing the 1833 Book of Commandments for printing. On April 19, 1834, while traveling to a conference, Joseph, Oliver, and Zebedee Coltrin blessed Sidney Rigdon “to have the Spirit to assist Elder Cowdery in conducting the *Star*” and “in arranging the Book of Covenants.” On the same occasion, they blessed Oliver “with wisdom and understanding sufficient for his station that he be qualified to assist Elder Rigdon in arranging the church Book of Covenants, which is soon to be published and have intelligence in all things to do the work of printing.”<sup>62</sup> When the Kirtland High Council issued an expanded charge to an enlarged committee on September 24, 1834, it specified that the items to be arranged as doctrine for the Church were to be “taken from the bible, book of Mormon, and the revelations which have been given to the Church up to

---

<sup>59</sup>See Paul Y. Hoskisson, “The Word of Wisdom: A Suggestion or a Commandment,” a paper delivered at the Mormon History Association annual meeting in May 2003, Kirtland, Ohio, 3–7. Alison Coutts has also pointed out to me how the language of D&C 28:5, 8, directed to Oliver Cowdery (“thou shalt not write by way of commandment, but by wisdom”) recurs in D&C 89:2.

<sup>60</sup>See Donald Q. Cannon and Lyndon W. Cook, *Far West Record: Minutes of the Church of Jesus Christ of Latter-day Saints* (Salt Lake City: Deseret Book, 1983), November 8, 1831 and April 30, 1832.

<sup>61</sup>See Richard O. Cowan, “The Living Canon,” in *Hearken, O Ye People*, no editor identified (Sandy, Utah: Randall Book, 1984), 17–30, quotation from p. 20.

<sup>62</sup>*History of the Church*, 2:51.

this date.”<sup>63</sup>

But there may not have been a clear, shared expectation of what *arrange* meant in each of these three statements. Apparently nothing like the lectures or the Oliver Cowdery compositions had been anticipated. Given this contrary evidence, it is somewhat surprising that Karl Best concludes that Joseph Smith “must have approved” the 1833–35 changes that originated with other members of the committee.<sup>64</sup> Ebenezer Robinson, who worked for Frederick G. Williams in the printing office and attended the 1835 conference, showed continuing sensitivity to this issue more than fifty years later when he wrote, “We attended that meeting, and noticed that a majority of those voting did so upon the testimony of those who bore record to the truth of the book, as they had . . . no means of knowing whether any alterations had been made in any of the revelations or not.”<sup>65</sup> In defending the changes before the 1835 edition was released, Oliver Cowdery wrote that, in reference to the 1833 Book of Commandments, he had been “surprised to find the previous print [by which he meant the printed 1833 Book of Commandments], so different from the original [transcriptions].” He explained: “We have given them a careful comparison, assisted by individuals whose known integrity and ability is uncensurable. . . . We believe they are now correct. If not in every word, at least in principle. For the special good of the church we have also added a few items from other revelations.”<sup>66</sup>

Other historians have also noted the informal relationships between Joseph Smith and his associates when it came to composing and publishing even important documents. David Whittaker traced the development of the Articles of Faith through several earlier documents aimed at summarizing the basic beliefs of the new church. He shows how Oliver Cowdery and both Orson and Parley Pratt may have

<sup>63</sup>Kirtland Council Minute Book, 63.

<sup>64</sup>Karl F. Best, “Changes in the Revelations, 1833 to 1835,” *Dialogue: A Journal of Mormon Thought* 25, no. 1 (March 1992): 102. David Whitmer’s accusation is in *An Address to All Believers in Christ*, 61.

<sup>65</sup>“Autobiography of Ebenezer Robinson,” *The Return*, vol. 1, no. 6 (1889): 88–89.

<sup>66</sup>See Oliver Cowdery’s reprint of the *Evening and Morning Star* 1, no. 1 (January 1835): 16.



made substantial contributions in this process.<sup>67</sup> Nor was Oliver Cowdery the only one of Joseph's associates to successfully resist his direction in publishing matters. Heber C. Kimball recorded John Taylor's refusal to allow Joseph Smith to meddle with the *Times and Seasons* after Joseph had appointed him to be the editor.<sup>68</sup> In contrast, Peter Crawley has shown how Parley P. Pratt revised two of his works after receiving public criticisms from Joseph.<sup>69</sup>

Why were the *Lectures on Faith* included in the 1835 edition of the Doctrine and Covenants? They were added to Joseph Smith's revelations along with two additional items whose author was Oliver Cowdery (possibly with W. W. Phelps's participation): the statements on government and marriage.<sup>70</sup> The preface to the 1835 edition, dated February 17, 1835, alludes rather clearly to each of these three nonrevelatory items, indicating that they had been written in response to criticisms of the Church.<sup>71</sup> Such criticism is generally recognized as the motive for the statement on marriage, which goes to

<sup>67</sup>David J. Whittaker, "The 'Articles of Faith,'" in *New Views of Mormon History*, edited by Davis Bitton and Maureen Ursenbach Beecher (Salt Lake City: University of Utah Press, 1987), 63–92.

<sup>68</sup>See Wilford Woodruff, "Historian's Office Private Journal," March 14, 1860, MS in Historical Department, LDS Church, and the discussion of this and other incidents in David J. Whittaker, "The Web of Print: Toward a History of the Book in Early Mormon Culture," *Journal of Mormon History* 23, no. 1 (Spring 1997): 1–41. The Kimball quotation is on p. 15 note 36. Woodruff's quotation is available in *Selected Collections*, Vol. 1, disk 17, image 25.

<sup>69</sup>Peter Crawley, *A Descriptive Bibliography of the Mormon Church: Vol. 1, 1830–1847* (Provo, Utah: BYU Religious Studies Center, 1997). See items 47 (78–79) and 62 (97–98).

<sup>70</sup>Bruce A. Van Orden has examined the common assumption that Oliver Cowdery wrote the 1835 statements on government and marriage. He advances persuasive evidence that Cowdery and Phelps worked together on these and that Phelps's background for writing the government statement in particular was significantly stronger than Cowdery's. See his "W. W. Phelps: His Ohio Contributions, 1835–36," in *Regional Studies in Latter-day Saint Church History (Ohio)*, edited by Milton V. Backman Jr. (Provo, Utah: BYU Department of Church History and Doctrine, 1990), 45–62.

<sup>71</sup>The reasons given for the Kirtland High Council having appointed

great lengths to make Mormon marriage look identical to nineteenth-century Christian American practices. Outside criticism is also commonly seen as the motive for the statement on government, which is mostly a summary of standard tenets of American democratic liberalism and makes no mention of distinctive political concepts in the Book of Mormon and other revelations to Joseph Smith.

With the benefit of hindsight, it is not difficult for us to recognize in these two statements some effort to allay criticisms of Joseph's emerging differences with the larger American culture. It should also be noted that this approach was characteristic of much of the early LDS engagement with Protestant America. In his 1973 study of LDS use of the Bible in the 1930s, Gordon Irving found that Mormons defended their restorationist claims principally with the Bible, secondly with "a reasoned common sense," and least frequently with Joseph Smith's revelations, to appeal more powerfully to skeptical audiences.<sup>72</sup> Similarly, viewing the *Lectures* as a response to criticism might help to explain their atypical style. There is evidence that some of the early brethren were embarrassed at Joseph's lack of education and the simple language of his revelations.<sup>73</sup> The idea of taking a leading role in the school for the elders or the publication process might

---

the committee to prepare these materials for publication are "adduced" by the committee to have been as follows: "They knew that the church was evil spoken of in many places—its faith and belief misrepresented, and the way of truth thus subverted. By some it was represented as disbelieving the Bible, by others as being an enemy to all good order and uprightness, and by others as being injurious to the peace of all governments civil and political." "Preface," Doctrine and Covenants, 1835, reprinted in *History of the Church* 2:251. The three common accusations listed in the last sentence are rebutted in the order given by (1) the lectures, (2) the statement on marriage, and (3) the statement on government. The revelations, on the other hand, were probably understood to be part of the reason for public disapproval of the Mormons.

<sup>72</sup>Gordon Irving, "The Mormons and the Bible in the 1830s," *BYU Studies* 13, no. 4 (1973): 473.

<sup>73</sup>Both Rigdon and Cowdery were among the ten elders at the November 1, 1831, conference in Hiram, Ohio, who expressed concerns over "the seemingly uneducated language found in the revelations then ready for printing." Lyndon W. Cook, *The Revelations of the Prophet Joseph Smith*

come easily to Oliver Cowdery, Frederick G. Williams, W. W. Phelps, and Sidney Rigdon, all of whom boasted some education and had at some point earned their living as school teachers or publishers. Furthermore, it may not be too much to see these expansions in the 1835 edition as a means of balancing Joseph's revelations with contributions from the other presidents—the two doctrinal statements from Cowdery (and Phelps), and the theological lectures from Rigdon. The other member of the presidency and signatory of the prefatory letter, Frederick G. Williams, probably did not contribute any compositions but did play a prominent role as the publisher or printer of the new volume.

It is not without interest that, when Rigdon left Nauvoo in 1844 and organized his own Church of Christ in Pittsburgh, he started up a paper (also called the *Messenger and Advocate*) and republished the seven Kirtland lectures in a monthly series between October 1845 and March 1846.<sup>74</sup> This action clearly indicates that Rigdon placed high value on the *Lectures*, quite plausibly due to his own primary role as author or chief author. In stark contrast, Joseph Smith's recorded teachings never referenced the *Lectures* even once. Also, while the *Lectures* include 147 Bible quotations, including 11 from the *Joseph Smith Translation*, the revelations to Joseph are cited only twice (Lecture 7), and the Book of Mormon is referred to only in Lecture 1, paragraph 19, and its rehearsal in the appended question 11.<sup>75</sup> The predominant stance of the *Lectures* is to support its arguments with reason and the Bible alone, and to ignore Joseph Smith's revelations.

But even Lecture 2, which contains so much factual and quoted material from Genesis, features as its central emphasized theme a uniquely Rigdonesque teaching which is nowhere endorsed by Joseph Smith and which seems on its face to derive directly from Sidney Rigdon's days when he was inspired by Alexander Campbell. The whole point of the endless quotations detailing the generations of

---

(Salt Lake City: Deseret Book, 1985), 107. Doctrine and Covenants 67 was given in direct response to those concerns (see esp. vv. 5–9).

<sup>74</sup>Sidney Rigdon, ed., "Faith," *Messenger and Advocate* (Pittsburgh, Penn.), 1 (October 15, 1845): 360, 364–66; 1 (November 1845): 385–89; 1 (December 1845): 405–7; 1 (January 1846): 422–24; 1 (February 1846): 443–45; 2 (March 1846): 449–52.

<sup>75</sup>Dahl and Tate, *Lectures on Faith in Historical Perspective*, 33–34, 36–37.

Adam's descendants in Lecture 2 is to demonstrate "that it was testimony, and human testimony only," which moved Adam's descendants "to inquire after the knowledge of God (51)." And further, "the evidence which these men had of the existence of a God, was the testimony of their fathers in the first instance (45)." Again, Lecture 2 emphasizes: "Let this class mark particularly that the testimony which these men had of the existence of God was the testimony of man" (46). This language and emphasis may sound both quaint and insignificant until one realizes that it is precisely this claim of Alexander Campbell that most offended other Christians in his day—the claim that the Holy Spirit could play no role in inspiring or motivating people to seek true knowledge of God until after they were baptized. Until that point, their faith was produced by the testimony of others who had direct experience of God, such as the testimonies of Jesus and his apostles recorded in the Bible.<sup>76</sup> For "there is not in all the Bible a promise of the Holy Spirit to any unbeliever."<sup>77</sup> Despite many letters of complaint about this teaching, Campbell consistently maintained that faith was merely belief in human testimony.

But Campbell's former star disciple was not the only Kirtland reader of his *Millennial Harbinger*. In a letter from Joseph Smith to the editor, Oliver Cowdery, dated September 24, Smith commented on the decline in Campbell's criticism of the Book of Mormon between 1832 and 1834, making it clear that he had been reading Campbell's paper for two years.<sup>78</sup> While Joseph did not specifically criticize the central teaching of Lecture 2 as discussed above, he was clearly teaching the opposite position during the early Kirtland period. In a personal letter to Moses Nickerson, November 19, 1833, Joseph explained: "You remember the testimony which I bore in the name of the Lord Jesus, concerning the great work which he has brought forth in the last days. You know my manner of communication, how that in weakness and simpleness I declared to you what the Lord had brought

---

<sup>76</sup>See, for example, Alexander Campbell, "The Confirmation of Testimony," *Millennial Harbinger* 1, no. 1 (January 4, 1830): 7–10; "Philaethes on the Scriptures," 1, no. 8 (August 2, 1830): 336–38; Letter to "Brother Semple," 1, no. 8 (August 2, 1830): 354–55.

<sup>77</sup>Alexander Campbell, *Millennial Harbinger* 4, no. 9 (September 1833): 457.

<sup>78</sup>Joseph Smith, Letter to "Dear Brother," September 24, 1834, *Evening and Morning Star* 2, no. 24 (September 1834): 192.

forth by the ministering of his holy angels to me, for this generation. I pray that the Lord may enable you to treasure these things up in your mind, for *I know that his Spirit will bear testimony to all who seek diligently after knowledge from him.*"<sup>79</sup>

In the same spirit, Joseph also taught people to ask their Heavenly Father to manifest the truth to them about his revelations, assuring them that the answer would come "by the power of his Holy Spirit," and urging them not to "be dependent on man for the knowledge of God."<sup>80</sup> Yet, at least four times in 1834 issues of the *Evening and Morning Star*, Rigdon used Campbell's formula, invoking the testimonies of the apostles and the Savior in the New Testament as a standard and sufficient basis for belief in certain teachings.<sup>81</sup>

One at least has to wonder if Joseph Smith really desired to push the *Lectures* ahead of his revelations in the new compilation, and to give pride of place to a new introductory letter and the *Lectures*, thus relegating the "Lord's Preface" and all his revelations to Part 2 of the volume. It is also worth noting that the presiding quorums of the Church eventually deleted the 1835 preface, the statement on marriage, and the *Lectures*. Of the several 1835 intrusions, only the statement on government and Cowdery's three introductory verses for Section 89 have been retained in the contemporary Doctrine and Covenants.

The 1835 preface was the first to go. When Orson Pratt undertook the 1876 edition, he added another twenty-six revelations, and, because the new section 132 conflicted with the statement on marriage, dropped it. Three years later, Pratt who was in England preparing another edition, requested permission from John Taylor, president of the Twelve, to drop the *Lectures on Faith*. Taylor denied the request, explaining that "the *Lectures on Faith* were published with the sanction and approval of the Prophet Joseph Smith, and we do not feel that it is desirable to make any alteration in that regard, at any

<sup>79</sup>Joseph Smith, *The Personal Writings of Joseph Smith*, compiled and edited by Dean C. Jessee (Salt Lake City: Deseret Book, 1984), 63; emphasis mine.

<sup>80</sup>Joseph Smith, "To the Honorable Men of the World," *Evening and Morning Star* 1, no. 3 (August 1832): 22.

<sup>81</sup>"Millennium," *Evening and Morning Star* 2, no. 23 (August 1834) 176, 177; "Millennium," *ibid.*, 2, no. 21 (June 1834): 161; and "Millennium," 2, no. 22 (July 1834): 169.

rate, not at present.”<sup>82</sup> Taylor’s letter to Pratt does not provide new insights into the *Lectures* or their origins. It specifically did not claim that Joseph Smith helped write the *Lectures*. Nor does it provide any further evidence for Joseph’s approval of the *Lectures* than any other reader would infer from seeing Joseph’s name included on the prefatory letter of 1835.

In 1921 the *Lectures* were finally dropped from the Doctrine and Covenants, and the presiding authorities of the Church chose to return to the 1833 model of the original Book of Commandments—featuring officially recognized revelations, introduced once again by the “Lord’s Preface” as Section 1.

#### TESTING AND CONFIRMING THE HYPOTHESIS OF RIGDON’S AUTHORSHIP

It may surprise those who have studied the authorship of the *Lectures on Faith* that other 1834–35 Kirtland publications offer excellent tests of my competing authorship hypotheses. Between December 1833 and June 1835, Sidney Rigdon wrote and serialized three long doctrinal essays in the *Evening and Morning Star* and the *Messenger and Advocate* entitled respectively “Faith of the Church of Christ in These Last Days,” “Millenium” [sic], and “Gospel.”<sup>83</sup> The *Lectures on Faith* were written and published in essentially the same time period. We know that Rigdon wrote the essays. If the claim that Joseph Smith wrote the *Lectures* is correct, we would not expect them to bear any significant rhetorical or stylistic similarity to Rigdon’s essays in the *Evening and Morning Star* and the *Messenger and Advocate*. However, should the essays be largely identical in style and rhetoric with the *Lectures*, we may reasonably conclude that Rigdon was the author. A careful, computer-assisted comparison of the four documents reveals a dramatic similarity—even identity—of style, rhetoric, and, to some extent, content. Even though the four items have different labels, their content tends to be quite similar, and the same phrases, terminology, reasoning, and style show up repeatedly. The only significant differ-

---

<sup>82</sup>John Taylor, letter to Orson Pratt, April 25, 1879, retained copy in John Taylor Letterbook, August 16, 1878–May 27, 1879, 710–13, LDS Church Archives.

<sup>83</sup>The first parts of the essays were published in the *Evening and Morning Star* until November of 1834 when they were continued in the *Messenger and Advocate*. See Appendix 1 for complete citations of these serialized articles.

ence is that the *Lectures* are shorter and less rambling; they have been reduced and tightened. But the distinctive rhetoric and vocabulary of Sidney Rigdon are pervasive. The long list of distinctive phrases listed in Appendix 2 occur only in the Rigdon materials and the *Lectures*, but not in the Joseph Smith materials.<sup>84</sup>

I first hired a freelance writer to read the Rigdon essays carefully—without knowing anything about the authorship or the purposes of the study—and to identify distinctive phrases, rhetorical devices, arguments, etc. This study makes no claim that another analyst would not find other additional examples of distinctive “Rigdonisms,” but the thirty-eight identified by the writer were deemed more than adequate for the needs of this study.

Second, using the WordCruncher program, we then looked for other occurrences of these thirty-eight items in the essays, the lectures, and in a comparable collection of known Joseph Smith writings from the same general period.

Third, I organized these thirty-eight “Rigdonisms” into five groups of similar constructions or of constructions that served the same rhetorical purposes. While almost all of them occurred in both the essays and the lectures, none occurred in the writings of Joseph Smith from this period. (See Appendix 2.)

The writing samples used in this analysis included roughly the same number of words from Joseph Smith and Sidney Rigdon (78,587 and 77,013 respectively), compared to the briefer *Lectures* (23,750 words). I have identified thirty-eight specific examples of the five kinds of Rigdonisms, which occur 163 times in these three Rigdon essays. All thirty-eight occur at least once in the *Lectures* and for a total of ninety-eight times. Given the much longer text of the essays, the frequency of these Rigdonisms in the *Lectures* (4.1 per thousand words) is almost double the rate of their occurrence in Rigdon’s essays (2.1 per thousand). And they do not occur at all in the writings of Joseph Smith for this period. This finding clearly refutes the claim that Joseph Smith wrote the *Lectures* and provides support against the assumption that either Oliver Cowdery or Joseph Smith invested

---

<sup>84</sup>The Joseph Smith texts used in this comparison include the Infobase electronic version of letters written from 1829 to 1834 and diary entries from 1832 to 1836, the years leading up to and immediately following the writing of the *Lectures*. *GospelLink: Deseret Book’s Master Reference Library*, CD-ROM (Salt Lake City: Deseret Book, 1998).

much effort in editing or rewriting them, which would most likely have reduced the frequency of the Rigdonisms. This simple analysis of Rigdonisms makes it easy to see why Elinore Partridge's stylistic analysis also identified Rigdon as the author of the *Lectures on Faith*.

### DISTINCTIVE RIGDON TEACHINGS

Several distinctive teachings of Rigdon's that appear in his essays also occur in easily recognizable form in the Kirtland lectures. A systematic analysis might identify more examples, but a few typical samples are sufficient to illustrate the point here. In "Faith," Rigdon twice repeats his understanding that, after the saints in this world die, they go on "to be ministering spirits unto them who are the heirs of salvation."<sup>85</sup> The same language and concept are also repeated twice in the *Lectures* (46, 47). I have already pointed out the affirmation in Lecture 2 of the Campbellite doctrine that faith comes only from hearing human testimony going back to someone who was a personal witness of God's voice and presence.<sup>86</sup> In "Faith," Rigdon emphasizes that only those who have "seen and heard" can "be a witness for God." No one else can "bear testimony of him."<sup>87</sup> Finally, the teaching we often hear quoted from the *Lectures* "that a religion that does not require the sacrifice of all things never has power sufficient to produce the faith necessary unto life and salvation," is echoed clearly in the *Messenger and Advocate* essay on faith, with explicit reference again to Abraham's near-sacrifice of Isaac.<sup>88</sup>

As with the analysis of rhetorical Rigdonisms, this analysis of doctrinal teachings tightly links Rigdon's essays in the *Evening and Morning Star* and the *Messenger and Advocate* to the *Lectures on Faith*.

### LECTURES RHETORIC AND 1830S PROTESTANTISM

The first thing most Latter-day Saints notice when reading the *Lectures* is that they are quite unlike the revelations and the other doctrinal statements by the General Authorities of the Restoration. This is largely due to their philosophical tone and repeated appeals to rea-

---

<sup>85</sup>Rigdon, "Faith," 54.

<sup>86</sup>Cf. *Lectures*, 15, 17, and 25.

<sup>87</sup>Rigdon, "Faith," 50, 51.

<sup>88</sup>Cf. *Lectures*, 44 with Rigdon, "Faith," 26 and 29.



son to settle issues for which no other evidence is offered. It was not unusual for early nineteenth-century preachers to feature rationalist rhetoric and philosophical posturing in their sermons because they could suggest unusual spiritual profundity to frontier audiences. Richard Bushman drew this same contrast between the rationalism of the Enlightenment-inspired Alexander Campbell and Walter Scott, Rigdon's most recent mentors, and the easy familiarity that Joseph Smith and his family displayed with voices, angelic visitations, visions, inspiration, and seerstones.<sup>89</sup> "The emphasis of the Campbellites was on distilling the essence of the Gospel from the scriptures, turning Bible stories and preachments into an orderly set of principles. Joseph Smith's revelations, on the other hand, made new sacred narratives that were themselves the foundation of belief."<sup>90</sup> It does not seem possible that Joseph Smith could suddenly revert to the Enlightenment posture of the Campbellites while writing lectures for the school of the elders. But for Sidney Rigdon, it would have taken effort—and possibly desires he did not have—to avoid doing just that.

Some writers on Joseph Smith and the development of LDS theology point to Lecture 5 as leading evidence that in the mid-1830s Joseph was following the binitarian doctrine of the godhead being promoted by Christian Primitivists of that decade. Lecture 5 clearly teaches that "there are two personages" who "constitute the . . . supreme power over all things" (83) and that the Son possesses "the same mind with the Father, which mind is the Holy Spirit (84)." Juxtaposed against more ambiguous statements in the Book of Mormon, the critics use Lecture 5 to paint a picture of significant later change in Joseph Smith's thinking about the godhead. But these critics have also recognized that Sidney Rigdon, the early convert from Campbellism, is the more likely source of the binitarian formulation of the *Lectures*.

Several characteristics of the fifth lecture seem to reflect the "dynamic" monarchianism of the Christian Connection.<sup>91</sup> The lecture never affirms the deity of Jesus but rather reflects their view that Jesus "possess[es] all the fulness of the Father . . . being begotten of him," that

---

<sup>89</sup>Bushman, *Joseph Smith and the Beginnings of Mormonism*, 184.

<sup>90</sup>*Ibid.*, 187.

<sup>91</sup>"Dynamic monarchianism" is a theological term referring to an understanding of the relationship among members of the godhead held by Christian Primitivists like Alexander Campbell and David Millard. Histori-

he shares the divine nature through the "Holy Spirit," and that through the same Spirit the saints can become one with the Father "as the Father and Son are one." . . . The lecture is consistent in its use of the term "Holy Spirit," a favorite with Campbell's movement, rather than the Mormon use of "Holy Ghost."<sup>92</sup>

In Nauvoo during a period of theological turmoil, Joseph Smith publicly disavowed any teaching of binitarianism and insisted, "I have always declared God to be a distinct personage, Jesus Christ a separate and distinct personage from God the Father, and that the Holy Ghost was a distinct personage and a Spirit: and these three constitute three distinct personages and three Gods."<sup>93</sup> Rather than trying to reconcile this 1844 statement with the *Lectures*, why should we not read it as Joseph's denial that he was the author of the troublesome sentences in Lecture 5?

David L. Paulsen recently argued in an unpublished lecture that Vogel and others were wrong to interpret Lecture 5 as a binitarian declaration.<sup>94</sup> He claims that such an interpretation is inconsistent with the *Lectures* themselves as well as contradictory to Church doctrine of the day, and to assert, as Vogel and others do, that the *Lectures on Faith* indicate early Mormon binitarianism is hasty and unjustified.

Paulsen supports his claim with three main arguments. First, interpreting the *Lectures on Faith* in a binitarian fashion is to propose an interpretation that is internally inconsistent, for Lecture 5 explicitly teaches that the godhead consists of three members: the Father, Son, and Holy Ghost.<sup>95</sup> Second, he claims that a comprehensive survey of evidence contemporary with the *Lectures* contradicts the binitarian

---

ans attribute its earliest version to Theodotus of Byzantium (fl. A.D. 190). Their basic claim was that only the Father was truly God. Jesus, as a mere mortal, shared in that divinity only to the extent that he was endowed with the Holy Spirit, thus showing all men how they might become one with God.

<sup>92</sup>Vogel, "The Earliest Mormon Concept of God," 27 note 11.

<sup>93</sup>Thomas Bullock, notes on a sermon given by Joseph Smith, June 16, 1844, as quoted in *History of the Church* 6:474.

<sup>94</sup>David L. Paulsen, "Binitarianism and the *Lectures on Faith*," paper presented at the Mormon History Association annual meeting, May 2003, Kirtland, Ohio. Photocopy in my possession.

<sup>95</sup>See Paulsen, "Binitarianism and the *Lectures on Faith*," 24.

thesis of critics like Vogel.<sup>96</sup> He argues instead that the best description of the understanding of God illustrated in early Mormon scripture, historical accounts, and other doctrinal writings, as well as the *Lectures* themselves is trinitarian, more specifically some form of social trinitarian.<sup>97</sup> Lastly, Paulsen asserts that there is no convincing evidence external to Lecture 5 that Rigdon adhered to a binitarian model of God.<sup>98</sup> Thus, regardless of their author, it is incorrect to view the *Lectures* as a doctrinal declaration of a church that adhered to a binitarian understanding of God.

Although Paulsen's approach differs from mine, the logic of our arguments is largely compatible. Paulsen asserts that, for his purposes, questions of authorship are largely irrelevant.<sup>99</sup> Likewise, the various theological interpretations of the *Lectures* do little to affect evidence regarding their authorship. However, in response to critics like Vogel, Paulsen's argument regarding the theological interpretation and the argument presented here regarding authorship are mutually constructive. If Rigdon was indeed the principal author of the *Lectures* and if, as Paulsen claims, there is significant evidence that Rigdon did not hold a binitarian understanding of God, arguments of critics like Vogel become more untenable. Regardless, however, of one's interpretation, Paulsen correctly notes that the *Lectures* are undeniably ambiguous and easily liable to misinterpretation, a fact that no doubt influenced their removal from the Doctrine and Covenants.<sup>100</sup> If the *Lectures* were not a binitarian declaration, Joseph may still have sought to distance himself from their ambiguous teachings because he recognized the misinterpretations that could arise.

The Protestantism of the *Lectures* is more than merely doctrinal. It is particularly evident in their rhetorical and stylistic dimensions. The need to examine them in the light of Protestant writings and lectures of the period remains. Louis Midgley has observed: "Some of the early leaders, coming as they did from sectarian backgrounds, seem to have felt a need for something approaching an orderly and authoritative setting forth of their beliefs. What they produced were initially called theological lectures, and they seem to have been mod-

---

<sup>96</sup>Ibid., 19.

<sup>97</sup>Ibid., 4–5.

<sup>98</sup>Ibid., 12–17.

<sup>99</sup>Ibid., 25.

<sup>100</sup>Ibid., 29.

eled after formal treatises like those by Charles G. Finney (1792–1875) or Alexander Campbell (1788–1866). But the formal methodology of these seven lectures has not been much adopted by other LDS writers.”<sup>101</sup>

Although the preface to the 1835 edition clearly acknowledges that many similar articles of religious faith were then extant, I have not been able to identify specific examples that were definitely circulated in Kirtland. However, to take one readily available example, the writings of Charles Grandison Finney, the famous frontier revivalist preacher of this period, are remarkably similar in both rhetorical technique and substantive content to the Kirtland lectures. When Finney later published his lectures, he also called them a course of “Theological Lectures.” He organized them in the same numbered paragraph format as the Kirtland lectures and ended each lecture with similar long lists of catechetical questions and answers. On the central issue of delineating the attributes of God that have to be understood before one can have faith, the Kirtland lectures and those of Finney develop remarkably similar lists.<sup>102</sup> Finney’s list of God’s moral attributes or dispositions includes benevolence, omniscience (*knowledge*), *justice*, *mercy*, and *truth*. The *Lectures on Faith* list *knowledge*, *faith* (power), *justice*, judgment, *mercy*, and *truth*. Neither of these looks much like a list that could be found anywhere in the revelations or teachings of Joseph Smith. Rather, they reflect the American Protestant discourse of the times. Furthermore, the *Lectures* set up an order of gospel principles featuring sacrifice, knowledge, faith, enduring temptation, and eternal life. This order differs fundamentally from both the Book of Mormon and Joseph Smith’s other revelations, which consistently emphasize repentance, baptism in water, and the gift of the Holy Ghost as central and essential elements of the gospel process by which human beings achieve eternal life.<sup>103</sup> Much more needs to be known before the extent of influence between frontier theologians like Finney and the Kirtland lectures can be determined, but it is not fanciful to see elements of the *Lectures* as imitating

---

<sup>101</sup>Louis C. Midgley, “Theology,” in *Encyclopedia of Mormonism*, 4:1475–76.

<sup>102</sup>Finney, *Skeletons of a Course*, 68, 76.

<sup>103</sup>The Book of Mormon pattern is analyzed in detail in Noel B. Reynolds, “The Gospel of Jesus Christ as Taught by the Nephite Prophets,” *BYU Studies* 31, no. 3 (Summer 1991): 31–50.

common Protestant theological discourse.

Given the explanation in the 1835 prefatory letter, it seems likely that the philosophical tone of the *Lectures* was a response to Protestant critics like Charles Finney, whose third lecture on theological method began with the assertion that “Mormonism is ridiculous credulity, founded in utter ignorance or a disregard of the first principles of evidence in relation to the kind and degree of testimony demanded to establish anything that claims to be a revelation from God.”<sup>104</sup> How else can the fact that the Kirtland lectures emulate the format, the philosophical tone, and the “principles of evidence” of Finney’s and Alexander Campbell’s lectures be explained? Such characteristics are consistent with the frequent appeal of the Kirtland *Lectures on Faith* to what Finney calls the “affirmations of reason,” which seem so out of place in Mormon writing with its distinctive emphasis on modern revelation and testimony. Assuming that the published version of Finney’s lectures reflects the style and content of what he and possibly others had been saying in earlier years on the western lecture circuit, even though he explains that they “have undergone repeated revisions, enlargement, and modification,”<sup>105</sup> these connections may indicate some influence on the mentality that produced the Kirtland lectures.

Despite the extensive rhetorical similarities between Finney’s later writings and the *Lectures on Faith*, I do not suspect any direct historical link between them. A revivalist preacher in New York, Finney often spent his summers at a farmhouse in Oneida County, New York. He was there between August and October 1834. By November 1834, about the same time preparations were being made for the school of the elders, Finney returned to New York City. In 1835, Finney accepted an offer to teach theology in Oberlin, Ohio. But no evidence of direct contact with the Latter-day Saints in nearby Kirtland during this period has been found.<sup>106</sup> It makes sense to cite him here as an obvious example of the discourse of contemporary Protestants in western New York and Ohio and how that discourse might also have

---

<sup>104</sup>Finney, *Skeletons of a Course*, 19.

<sup>105</sup>*Ibid.*, 1:4.

<sup>106</sup>Biographies on Finney and compilations of his work include Charles F. Hambrick-Stowe, *Charles G. Finney and the Spirit of American Evangelicalism* (Grand Rapids, Mich.: Eerdmans, 1996); Keith J. Hardman, *Charles Grandison Finney, 1792–1875: Revivalist and Reformer* (Syracuse,

shaped the expectations of the author of the *Lectures on Faith*.

### CONCLUSIONS

To sum the findings of this study, historical evidence, authorship studies, and textual content and style provide persuasive refutation of the recurring assumption in some LDS circles that Joseph Smith authored the *Lectures on Faith*. In none of these aspects is there any clear link of the *Lectures* to Joseph Smith as author. Rather, on every point, the evidence points away from Joseph to Sidney Rigdon. And the comparison of the *Lectures* with the concurrently written Rigdon essays in the *Evening and Morning Star* and the *Messenger and Advocate* seems to provide the long-missing “smoking gun.” In the light of such extensive internal similarities and duplications of thought and language, it does not seem reasonable to maintain that the *Lectures* had any other author. Recognizing Sidney Rigdon as the principal author makes it much easier to understand the rationalistic and theological stance of the *Lectures*, their similarities in style and content with the lectures of such frontier phenomena as Charles Grandison Finney, their inconsistencies with standard LDS teaching, their noticeably “Protestant” flavor, and Rigdon’s eagerness to publish them in his own newspaper after leaving the Church.

To the extent that this study has raised legitimate questions about this enigmatic document, there may be good reason for students of Mormon history to look more closely at the Protestant environment of the *Lectures*, at Sidney Rigdon’s thought and rhetorical style during the Kirtland period, and at his influence in those early days of the Church.

### APPENDIX I

#### CITATIONS FOR SIDNEY RIGDON’S ESSAYS

“Faith of the Church of Christ in These Last Days”  
*Evening and Morning Star*

---

N.Y.: Syracuse University Press, 1987); Garth M. Rosell, Richard A. B. Dupuis, and Charles Grandison Finney, eds., *The Original Memoirs of Charles G. Finney* (Grand Rapids, Mich.: Zondervan, 2002); and G. Frederick Wright, *Charles Grandison Finney* (Boston: Houghton Mifflin, 1891).

- Part I: 2, no. 17 (February 1834), 130–31.  
 Part II: 2, no. 19 (April 1834): 145–46.  
 Part III: 2, no. 20 (May 1834): 153–54.  
 Part IV: 2, no. 21 (June 1834): 162–63.  
 Part V: 2, no. 22 (July 1834): 170–72.  
 Part VI: 2, no. 23 (August 1834): 178–79.  
 Part VII: 2, no. 24 (September 1834): 186–87.  
*Messenger and Advocate*  
 Part VIII: 1, no. 2 (November 1834): 19–20.  
 Part IX: 1, no. 3 (December 1834): 35–37.  
 Part X: 1, no. 4 (January 1835): 51–53.  
 Part XI: 1, no. 5 (February 1835): 68–71.  
 Part XII: 1, no. 6 (March 1835): 83–84.  
 [Part XIII:] 1, no. 8 (May 1835): 126–28.  
 [Part XIV:] 1, no. 9 (June 1835): 133–35.  
 [Part XV:] 1, no. 11 (August 1835): 164–66.

“Millenium” [sic]

- Evening and Morning Star*  
 Part I: 2, no. 15 (December 1833): 117.  
 Part II: 2, no. 16 (January 1834): 126–27.  
 Part III: 2, no. 17 (February 1834): 131.  
 Part IV: 2, no. 19 (April 1834): 146–47.  
 Part V: 2, no. 20 (May 1834): 154–55.  
 Part VI: 2, no. 21 (June 1834): 161–62.  
 Part VII: 2, no. 22 (July 1834): 169–70.  
 Part VIII: 2, no. 23 (August 1834): 177–78.  
*Messenger and Advocate*  
 Part IX: 1, no. 2 (November 1834): 17–19.  
 Part X: 1, no. 3 (December 1834): 39–40.  
 Part XI: 1, no. 4 (January 1835): 53–54.  
 Part XII: 1, no. 5 (February 1835): 67–68.  
 Part XIII: 1, no. 6 (March 1835): 84–87.  
 Part XIV: 1, no. 8 (May 1835): 116–18.

“Gospel”

- Evening and Morning Star*  
 Part I: 2, no. 24 (September 1834): 187–88.  
*Messenger and Advocate*  
 Part II: 1, no. 2 (November 1834): 20–21.  
 Part III: 1, no. 3 (December 1834): 37–39.  
 Part IV: 1, no. 4 (January 1835): 54–56.  
 Part V: 1, no. 5 (February 1835): 71–77.  
 Part VI: 1, no. 6 (March 1835): 87–89.

Part VII: 1, no. 8 (May 1835): 118–20.

Part VIII: 1, no. 9 (June 1835): 131–33.

APPENDIX 2

DISTINCTIVE “RIGDONISMS” IN THE *LECTURES ON FAITH*  
AND IN RIGDON’S ESSAYS

<i>Types of Constructions</i>	<i>Specific Rigdonisms</i>	<i>Occurrences in Rigdon’s Essays*</i>	<i>Occurrences in Lectures on Faith**</i>
Habitual phrase or cliché	Biblical prophets or authors referred to as “the sacred writers.”	12 - FC II:5; III:3; XIV:1. M IV:4, 23, 26; VI:5, 19; VII: 9,10, 29; XI:3	3 - 1:17, 22; 3: Q&A 23
	Revelations, scriptures, records which “are extant.”	7 - FC I:5; IV:4; VI:1; III:3; V:2; V:17. G VII:2	1 - 6:11
	References to “the saints of former days” or “former day saints.”	19 - FC III:1; IV:7, 8; V:11; VI:1; VII:1, 2; X:1, 6, 7; XIII:2; XIV:2, 4; XV:10. M II:6; III:3. G IV:4, 5, 6	3 - 3:26 (three times)
	God “calculated” men’s situation to promote their faith and salvation.	2 - FC IV:6. G IV:1	2 - 3: Q&A:23; 7:13
	Subjects are “clearly set forth.”	5 - FC XII:3, 5. M III:4; IX:4 (twice)	1 - 7:9
	Luke or Moses referred to as “the historian.”	2 - FC XI:6; XIV:4	1 - 2:5

*Abbreviations:* FC = “Faith of the Church”; M = “Millenium” (consistently misspelled in Rigdon’s essays); G = “Gospel”

\*Notes: The Roman numerals indicate the serialized part from the original publications in the *Evening and Morning Star* (1834) and the *Messenger and Advocate* 1833–35; the arabic numbers following indicate the paragraph.

\*\*In each reference from the *Lectures on Faith*, the first number indicates the lecture and the second the paragraph.



<i>Types of Constructions</i>	<i>Specific Rigdonisms</i>	<i>Occurrences in Rigdon's Essays</i>	<i>Occurrences in Lectures on Faith</i>
	Beginning a list or argument with "in the first instance."	2 - FC XI:9; XV:5	10 - 2:20, 33, 56, Q&A 9, 143; 3:1, 7, 19, Q&A 3; 4:3
	Ancient apostles referred to as "the fishermen of Galilee."	2 - G I:15, 16	1 - 7:20
	"Righteous Abel" as a stock phrase (Matt. 23:35).	3 - FC VII:6. M IV:7. G VII:1	1 - 6:8-9
	The gospel is "the scheme of life and salvation."	7 - FC V:5; VII:7; XI:4. G I:21, 22; V:1; VI:3	1 - 7:17
	"If the question is asked . . . the answer is given."	1 - M IV:6	1 - 7:18
Claims of rational process	Belief requirements of "rational beings" cited.	4 - FC III:7; XIII:7. M VIII:6. G IV:3	7 - 2:2; 3:2; 3:5; 3: Q&A 14; 4:11; 4: Q&A 6, 8
	Some aspect of faith or religion termed a "science."	1 - G I:5	4 - 1: Q&A 1, 2, 3; 7:5
	Scripture quotations are combined to support an assertion by "putting sayings (or an account, etc.) together."	1 - M VII:13	2 - 7:12, 19
Favorite scripture paraphrased	Principles given for attaining future/eternal felicity.	(D&C 77:3) 1 - FC XI:2	1 - 7:6
	The "ancients were enabled to endure as seeing Him who is invisible."	(Heb. 11:27) 1 - FC XIV:2	1 - 6:11

<i>Types of Constructions</i>	<i>Specific Rigdonisms</i>	<i>Occurrences in Rigdon's Essays</i>	<i>Occurrences in Lectures on Faith</i>
	Abel's example of a sacrifice "acceptable to God" serves as an example for us or for Abraham.	(Moses 6:3) 1 - FC VII:6	1 - 6:8-9
	Angels referred to as "ministering spirits to them who are the heirs of salvation."	(Heb. 1:4; D&C 7:6; 76:88) 1 - FC XV:8	2 - 7:4, 9
	"All things that pertain to life and godliness were given unto them."	(2 Pet. 1:3) 3 - M VIII:9 (three times)	3 - 7:18, 19, 20
	Through faith, the prophets of the scriptures "stopped the mouths of lions, quenched the violence of fire, escaped the edge of the sword, waxed valiant in fight."	(Heb. 11:34) 1 - FC II:9	3 - 1:20; Q&A 11; 7:17
	"took joyfully to the spoiling of their goods."	(Heb. 10:34) 2 - FC VI:2. M IV:24	2 - 6:2, 3
Question-begging in lieu of an argument to establish a point	None "need mistake" or "could mistake" a teaching or meaning.	9 - FC IX:1; XII:1. M II:5; IV:5, 25; V:3; VI:10; IX:4. G II:3	1 - 7:18
	Use of "never had" or "never was" to emphasize certainty of a point.	10 - FC III:3, 5; V:2; X:1, 5, 7; XIV:1. G VI:1. M III:3; VII:11	1 - 6:7
	Points in argument termed "facts" or "important facts."	4 - FC VII:4; VIII:10. M X:1. G VII:4	3 - 2:25, 53, 55
	No fact or language is or can be "plainer than this."	3 - FC VII:4; X:1. G V:3	1 - 7:13
	Plain meaning claimed in that "no mistake" need be admitted or made.	8 FC XI:1; XII:1. M II:5; IV:5, 25; V:3; VI:10; IX:4	1 - 7:18

<i>Types of Constructions</i>	<i>Specific Rigdonisms</i>	<i>Occurrences in Rigdon's Essays</i>	<i>Occurrences in Lectures on Faith</i>
	Question begging masked by the assertion that "there can be no doubt."	4 - FC X:1; XV:10. M V:14. G V:12	1 - 2:47
	Need for evidence finessed by saying "there will be no dispute."	1 - M IX:2	2 - 2: Q&A 11; 7:9
	"Candid" minds or people will see the truth of the matter.	8 - FC V:3; X:2; XIV:7. M V:14; VI:18; VIII:11. G VI:1; VII:4	1 - 4:7
	Absence of argument masked by asking "who cannot see that...?"	3 - FC VIII:9. M IX:4. G II:3	5 - 1:17; 2:49; 3:24; 7:15, 17
	Avoids lengthy quoting of scripture by saying it "would not be to our purpose at present."	1 - G V:10	1 - 2:47
Habitual rhetorical device	Rhetorical break introduced by "Let us here observe."	2 - FC VIII:1. M VI:4	5 - 2:55; 3:2, 26; 4:2; 7:7
	Arguments sometimes make it "necessary to go back" to the beginning for evidence.	1 - FC XI:1	2 - 2:3, Q&A 6
	"Belief in the Bible" as a characteristic that is lacking in some.	9 - FC I:12; II:1, 5, 6; III:4, 8. M V:2. G I:1; IV:1	1 - 7:9
	Introduction of scriptural quotations by "we shall proceed to show" or "we shall now notice," etc.	3 - FC XIII:2. M V:4. G VII:3	7 - 2:1, 5, 12, 20; 3:6; 4:1, 3
	"Let the reader (or class) mark" used to signal an important assertion that is coming immediately after.	6 - FC IX:5; XII:2. M VIII:9; IX:4. G V:8; VI:1	1 - 2:35

<i>Types of Constructions</i>	<i>Specific Rigdonisms</i>	<i>Occurrences in Rigdon's Essays</i>	<i>Occurrences in Lectures on Faith</i>
	"Let the reader (or mind) reflect (or notice, etc.)" used to signal an important assertion that will follow.	10 - FC VII:5; XI:9; XIII:4, 7. M VIII:4; IX:4; XII:8, 9. G I:14; III:9	1 - 4:17
	"Is/Is not necessary to observe/go back" or "let us here observe" used as a transition.	3 - FC VIII:1; XV:7. M VI:4	9 - 2:3, 55, Q&A 6; 3:2, 26; 4:2; 7:2, 7, 15

*This article replaces its earlier appearance in the Journal 31 (Summer 2005): 70–88, which had an incorrect formula and a missing table. The Journal sincerely regrets these errors.*

# RECONSTRUCTING THE Y-CHROMOSOME OF JOSEPH SMITH: GENEALOGICAL APPLICATIONS

*Ugo A. Perego, Natalie M. Myres, and Scott R. Woodward*

## INTRODUCTION

DURING THE LAST HALF of the nineteenth century, when the contest of authority between the Church of Jesus Christ of Latter-day Saints and the Reorganized Church of Jesus Christ of Latter Day Saints (now Community of Christ) was most intense, a key point in the RLDS attack on the LDS insistence that Joseph Smith Jr.<sup>1</sup> originated polygamy was the absence of fully documented children produced by his unions with about thirty plural wives.<sup>2</sup>

The controversy faded away in the 1980s as RLDS historians, leaders, and members generally accepted the overwhelming docu-

---

UGO A. PEREGO {ugo@smgf.org} is Director of Operations, Sorenson Molecular Genealogy Foundation {www.smgf.org}. NATALIE M. MYRES {natalie@smgf.org} is Director of Research and Development and Co-principal Investigator, Sorenson Molecular Genealogy Foundation. SCOTT R. WOODWARD {scott\_woodward@byu.edu}, is Professor of Microbiology and Molecular Biology, Brigham Young University, Provo, Utah and Principal Investigator, Sorenson Molecular Genealogy Foundation. Address queries to Natalie Myres at 2511 S. West Temple, Salt Lake City 84115, phone (801) 461-9792.

<sup>1</sup>For simplicity's sake, we refer to him as Joseph Smith. The Jr./Sr. designations appear only in Figures 1 and 2.

<sup>2</sup>Andrew Jenson, "Plural Marriage," *Historical Record* 6 (May 1887): 233–34; Fawn Brodie, *No Man Knows My History: The Life of Joseph Smith, the Mormon Prophet*, 2d ed. rev. (1945; New York: Alfred A. Knopf, 1971),

mentary support that plural marriage originated in Nauvoo with Joseph Smith.<sup>3</sup> Yet even though this historical question has lost its controversial content, it has remained unanswered: Where are the children, if any, of Joseph Smith by his plural wives? One plural wife, Mary Elizabeth Rollins Lightner, stated that she knew “he had three children. They told me. I think two are living today but they are not known as his children as they go by other names.”<sup>4</sup>

This ambiguity means that a group of families have harbored traditions, taken with various degrees of seriousness, that such-and-such an ancestor from the Nauvoo period whose mother is known to have been a plural wife of Joseph Smith may have been Joseph’s child as well. These children may have included Oliver Buell (son of Presendia Huntington Buell, wife of Norman Buell), John Reed Hancock (son of Clarissa Reed Hancock, wife of Levi Hancock), Moroni Llewellyn Pratt (son of Parley P. Pratt’s wife, Mary Ann Frost Pratt), Orson Washington and Frank Henry Hyde (two sons of Orson Hyde’s wife, Nancy Marinda Johnson Hyde), Josephine Rosetta Lyon (daughter of Sylvia Sessions Lyon, wife of Winsor Lyon),<sup>5</sup> an alleged

---

345–46, Appendix C, 457–88; Todd Compton, *In Sacred Loneliness: The Plural Wives of Joseph Smith* (Salt Lake City: Signature Books, 1997), 4–8.

<sup>3</sup>For a literature review of Joseph Smith III’s position, RLDS works defending the position, the key 1983 work of RLDS Church Historian Richard P. Howard in opening “the door of acceptance” toward a more professional view, and subsequent literature assimilating this revised position, see Martha Sonntag Bradley, “Out of the Closet and into the Fire: The New Mormon Historians’ Take on Polygamy,” in *Excavating Mormon Past: The New Historiography of the Last Half Century*, edited by Newell G. Bringhurst and Lavina Fielding Anderson (Salt Lake City: Greg Kofford Books, 2004), 307–8.

<sup>4</sup>Compton, *In Sacred Loneliness*, 12. See his summary (12–13) of possible reasons for the fewness of Joseph’s children and his conclusion: “It is clear that some of his plural wives did have children by him, if we can rely on the statements of George A. Smith, Josephine [Lyon] Fisher, and Elizabeth Lightner.”

<sup>5</sup>Josephine made an affidavit on February 24, 1915, affirming that Sylvia, on her deathbed in 1882, “told me that I was the daughter of the Prophet Joseph Smith.” *Ibid.* 183, 681. Although this claim offers the strongest documentation, it cannot be tested by the Y-chromosome methods described in this paper because it is a father-daughter descent, rather than a fa-

child born to Fanny Alger during the Kirtland period,<sup>6</sup> Zebulon Jacobs (son of Zina Diantha Huntington Jacobs, wife of Henry Jacobs),<sup>7</sup> and an alleged son of Hannah Dubois Smith Dibble.<sup>8</sup>

Researchers interested in the question have had to rely on probabilities: Was a child born to a plural wife after her sealing to Joseph Smith and within eight or nine months of his death in June 1844? Were there known opportunities for cohabitation? Do later family accounts provide any support for such a hypothesis? Even shakier evidence is the possibility of physical resemblances. Fawn Brodie, for instance, published Oliver Buell's portrait with those of Joseph's four surviving sons by Emma and states that his "physiognomy . . . seems to weigh the balance overwhelmingly on the side of Joseph's paternity."<sup>9</sup>

This article reports a form of DNA testing, which was used to answer the question of whether a given man who has living descendants through an unbroken father-son line was or was not a son of the Prophet Joseph Smith. Based on the availability of living descendants, three separate genetic investigations into the paternity of these men have been completed.

#### GENETIC TESTING AND PEDIGREE COMPLETION

In recent years, the use of computer-based genealogical resources has dramatically increased our ability to access historical records. Also available are large computerized databases containing pedigree-linked information, which combine the research findings of many individuals into a format quickly and easily retrieved over the internet. With these advances, it has become increasingly evident that, although a greater amount of information is available, it can often be ambiguous. Often difficulties associated with immigration, adoption, illegitimacy, and poor research result in records that are incomplete and inconsistent. In addition, some records have been lost, destroyed,

---

ther-son descent.

<sup>6</sup>Brodie, *No Man Knows My History*, 345.

<sup>7</sup>Richard S. Van Wagoner, *Mormon Polygamy: A History* (Salt Lake City: Signature Books, 1989), 48–49.

<sup>8</sup>Compton, *In Sacred Loneliness*, 631. This may not be a comprehensive list of those who may have believed in possible descent from Joseph Smith.

<sup>9</sup>Brodie, *No Man Knows My History*, 301, portrait facing 299. Unfortunately, since depictions of Joseph Smith are limited to a couple of profiles, portraits, and his death mask, this argument is not particularly strong.

or simply never kept. Genealogical research based on these sources may lead to the hypothesis of a family relationship yet provide insufficient or conflicting evidence to confidently establish the link.

In situations where there is inadequate documentation to resolve a genealogical question, genetic testing may either support or disprove the existence of specific family relationships. The Sorenson Molecular Genealogy Foundation (SMGF), a nonprofit organization located in Salt Lake City, is currently building the world's largest and most comprehensive database of correlated genetic and genealogical information. Researchers at SMGF are expanding the use of DNA testing and are developing new applications with the goal of assisting genealogists with their research. Occasionally, requests are received to work on side projects that could be used to teach about and to promote the usefulness of genetic testing to complement traditional genealogical research.

One of these studies involved the reconstruction of the Y-chromosome to assist in locating the exact birthplace of Joseph Smith's paternal third-great-grandfather, a Robert Smith of Boxford, Massachusetts, who emigrated from Lincolnshire, England in the earlier part of the seventeenth century. Although the research for Joseph Smith's ancestor is still underway, the genetic information generated from this study can also be used to answer specific questions about Joseph Smith's posterity.

DNA markers from specific regions of the Y-chromosome are particularly useful in the reconstruction of paternal genealogies because the Y-chromosome is found exclusively in males and follows a strict inheritance pattern from father to son, similar to the family surname in most western cultures.<sup>10</sup> Unlike the other twenty-two pairs of chromosomes, it does not include genetic material from the mother. A set of small segments (known as markers or loci) on the Y-chromosome can produce a very specific DNA profile (called a haplotype) that can uniquely identify a paternal lineage. The analysis of each of these markers yields a measurable count, or allele value, for that specific marker. For example, at location DYS391<sup>11</sup> on the Y-chromosome, one male may have an allele value of 10 while another may have an allele value of 11 at the same location. The entire set of these values constitutes the

---

<sup>10</sup>Mark A. Jobling, "In the Name of the Father: Surnames and Genetics," *Trends in Genetics* 17, no. 6 (June 2001): 353-57.

<sup>11</sup>DYS is an acronym for "DNA Y-chromosome Segment. The number



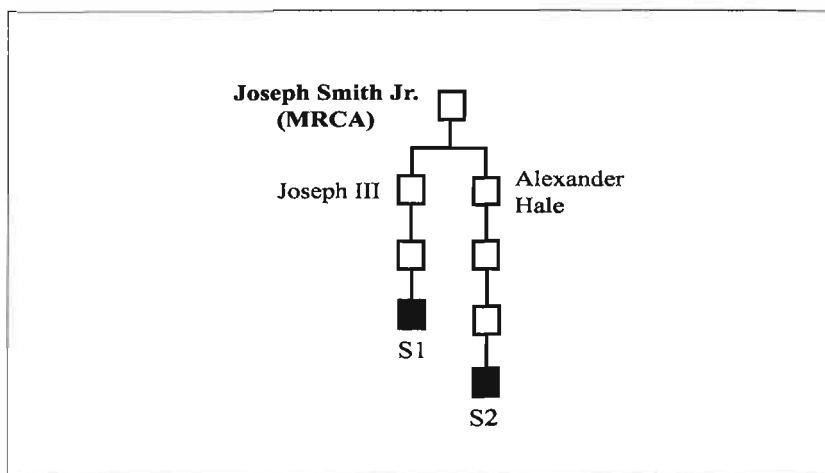

Figure 1. Pedigree chart representing the relationship of the two individuals who volunteered a DNA sample for the reconstruction of Joseph Smith's Y-chromosome haplotype. Joseph Smith Jr. is the most recent common ancestor (MRCA) on the paternal line for males S1 and S2 through Alexander Hale Smith and Joseph Smith III.

Y-chromosome haplotype for an individual and a unique genetic combination that characterizes his paternal ancestry. To increase the accuracy of Y-chromosome testing with the case studies presented in this paper, we tested each individual at twenty-four loci. Testing fewer markers would reduce the level of confidence in the results.

We reconstructed the Y-chromosome profile for Joseph Smith by obtaining genetic samples from living male descendants of two of Joseph's sons, Alexander Hale Smith and Joseph Smith III.<sup>12</sup> Because males receive their Y-chromosome DNA from their father essentially unchanged, it would be expected that male descendants from a common paternal ancestor would share the exact same values at all of their Y-chromosome loci. (See S1 and S2 in Figure 1.) The Y-chromosomes from the living descendants were identical, thus allowing us to infer with a high degree of confidence Joseph Smith's probable Y-chromosome haplotype. (See Table 1.)

---

that follows DYS indicates a particular marker, or locus (plural *loci*) found along the Y-chromosome.

<sup>12</sup>Names of living sample donors are withheld because of confidentiality agreements.

**TABLE 1**  
**JOSEPH SMITH'S INFERRED**  
**Y-CHROMOSOME HAPLOTYPE**

<i>Locus</i>	<i>S1 Descendant of Joseph Smith through his son Joseph III</i>	<i>S2 Descendant of Joseph Smith through his son Alexander H.</i>	<i>Joseph Smith Inferred Y-ch. Haplotype (MRC A)</i>
1 DYS 19	14	14	14
2 DYS385	11, 13	11, 13	11, 13
3 DYS388	12	12	12
4 DYS389I	14	14	14
5 DYS389II	30	30	30
6 DYS390	24	24	24
7 DYS391	11	11	11
8 DYS392	14	14	14
9 DYS393	13	13	13
10 DYS426	12	12	12
11 DYS437	15	15	15
12 DYS438	12	12	12
13 DYS439	12	12	12
14 DYS447	25	25	25
15 DYS454	11	11	11
16 DYS455	11	11	11
17 DYS460	11	11	11
18 DYS461	11	11	11
19 DYS462	11	11	11
20 GAAT1B07	10	10	10
21 YCAII	19, 23	19, 23	19, 23
22 Y-GATA-A10	13	13	13
23 Y-GATA-C4	23	23	23
24 Y-GATA-H4	12	12	12

*Note:* We defined Joseph Smith's haplotype by DNA obtained from two living male descendants of two of Joseph's sons, Alexander Hale Smith and Joseph Smith III. All twenty-four loci of their Y-chromosome haplotypes were identical.

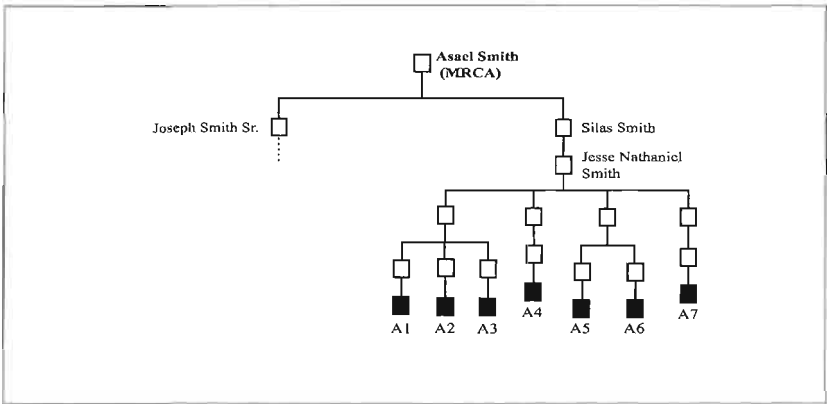

Figure 2. Pedigree chart representing the relationship of seven individuals identified in the Sorenson Molecular Genealogy Foundation database sharing a common paternal ancestor with Joseph Smith Jr. through Asael Smith, the most recent common ancestor (MRCA). These individuals have one or zero mismatches to the Joseph Smith Jr. haplotype.

To confirm that the inferred haplotype uniquely identifies Joseph Smith's lineage and does not resemble it merely by chance, we randomly selected fifty-six men surnamed Smith from the Sorenson Molecular Genealogy Foundation database and cross-typed their Y-chromosome haplotypes. Forty-nine of the fifty-six had two or more mismatched loci when compared to the Joseph Smith inferred haplotype. Standard genetic statistical studies have determined that individuals who match twenty-two out of twenty-four loci likely share a most recent common paternal ancestor approximately twenty-one generations in the past.<sup>13</sup>

We investigated further and found that the remaining seven individuals from the Sorenson database, who had either one or no mismatches to the Joseph Smith haplotype, shared a common paternal line with Joseph Smith through his grandfather, Asael Smith. (See A1–A7 in Figure 2.) This result also allowed us to infer the Y-chromosome haplotype for Asael Smith.

<sup>13</sup>Bruce Walsh, "Estimating the Time to Most Recent Common Ancestor for the Y Chromosome or Mitochondrial DNA for a Pair of Individuals," *Genetics* 158 (June 2001): 897–912. This figure has a 95 percent confidence interval of 4.8–56.2 generations. For more information about confidence intervals, please refer to a textbook on statistics.

Although the Y-chromosome is transmitted directly from father to son, possible mutations at each of the marker loci could change the allele value at one or more loci. Rates of mutation under ordinary circumstances are well established, with an estimated average mutation rate of 0.28 percent for Y-STR loci per generation.<sup>14</sup> This rate indicates that a specific marker inherited along the paternal line may change at any given generation, but the probability of this occurrence is small. When these mutations do occur, they can be used to estimate how many generations separate two individuals sharing a common paternal ancestor. When taking into account the mutation rate, closely related individuals on the paternal line may possess haplotypes differing by one of twenty-four loci. Individuals having two or more differences in their haplotypes are likely to share more distant common ancestry. Given the number of generations that have passed since Joseph Smith's lifetime, it is likely that individuals with haplotypes differing by more than two loci from the Joseph Smith haplotype do not descend directly from his paternal line.<sup>15</sup>

While there are currently more than 2,000 surname studies using Y-chromosome testing to link family lines descending from a potential common paternal ancestor,<sup>16</sup> one of the first instances where this test was used to support the existence of a familial relationship was the highly publicized 1998 Jefferson-Hemings case.<sup>17</sup> That study, which uses analysis strategies similar to this study, demonstrated the usefulness of Y-chromosome testing in establishing a possible biological connection between two separate lineages. By testing the Y-chro-

---

<sup>14</sup>Manfred Kayser et al., "Characteristics and Frequency of Germline Mutations at Microsatellite Loci from the Human Y Chromosome, as Revealed by Direct Observation in Father/Son Pairs," *American Journal of Human Genetics* 66 (May 2000): 1580–88.

<sup>15</sup>As Val D. Rust, *Radical Origins: Early Mormon Converts and Their Colonial Ancestors* (Urbana: University of Illinois Press, 2004), points out, many early Mormon converts shared common ancestors and therefore were biologically related to each other. However, Y-chromosome testing identifies unique ancestors on the direct paternal line.

<sup>16</sup>Chris Pomery, *DNA and Family History*, retrieved April 1, 2005, from <http://www.dnaandfamilyhistory.com/genetic-genealogy-leading-dna-projects.shtml>.

<sup>17</sup>Eugene A. Foster, et al., "Jefferson Fathered Slave's Last Child," *Nature* 396 (November 1998): 27–28.

mosome of male descendants from both families, researchers were able to confirm a long-standing family rumor indicating that President Thomas Jefferson's slave, Sally Hemings, bore a child whose father was a member of the Jefferson family.

Beginning in 2003, we had the opportunity to apply this type of genetic testing to a case study of three purported sons of Joseph Smith by plural wives: Moroni Llewellyn Pratt, Zebulon Jacobs, and Orrison Smith.

### THE CASE STUDY CANDIDATES

#### *Moroni Llewellyn Pratt*

Moroni L. Pratt was born on December 7, 1844. His mother, Mary Ann Frost, was civilly married to Parley P. Pratt on May 14, 1837, and sealed posthumously to Joseph Smith on February 6, 1846.<sup>18</sup> Although there is no record that Mary Ann was sealed to Joseph Smith during his lifetime, family historian Robert Steven Pratt "suspects a marriage to Joseph Smith while he lived," perhaps because Parley stood as proxy for Joseph Smith during her posthumous sealing to him and because she left Parley and did not go west with his other wives.<sup>19</sup> Brodie also identifies Moroni as a possible child of Joseph Smith.<sup>20</sup>

To determine Moroni Pratt's biological father, we conducted genetic analysis on the Y-chromosomes of direct patrilineal descendants of Moroni L. Pratt, Parley P. Pratt, and Joseph Smith.

---

<sup>18</sup>Thomas Milton Tinney, *The Royal Family of the Prophet Joseph Smith, Junior; First President of the Church of Jesus Christ of Latter-day Saints* (N.p.: Tinney-Green[e] Family Organization Publishing Company, 1973), 12, L. Tom Perry Special Collections, Lee Library, Brigham Young University, Provo, Utah, records this proxy sealing information: "GS# 183, 374—Res. Page 513–514 Proxy Sealings, # 3660—Joseph Smith, Junior. Sealing Date: 6 Feb 1846 at 1:30 P.M. solemnized by H.C. Kimball; Witnesses &: [meaning more than one witness] Wm. Redfield F.D. Richards—No. 19, page 3. M.S. #1 Mary Ann Frost, #3164, born 14 Jan 1809 at Groton, Caledonia, Vermont; #2 Parley P. Pratt, #3163, Proxy for time."

<sup>19</sup>Compton, *In Sacred Loneliness*, 763 note V.

<sup>20</sup>Brodie, *No Man Knows My History*, 345, 484.

*Zebulon Jacobs*

Similarly, Zebulon Jacobs, born to Zina Diantha Huntington Jacobs Smith on January 2, 1842, is recorded as a possible child of Joseph Smith.<sup>21</sup> On March 7, 1841, Zina was civilly married to Henry Bailey Jacobs. Nine months later, on October 27, 1841, when she was already pregnant with Zebulon, she was sealed to Joseph Smith.<sup>22</sup> While there is sufficient evidence to document Zina's two marriages, the paternity of her first son remains unresolved.<sup>23</sup> To establish Zebulon's true paternity, we generated Y-chromosome profiles from DNA samples obtained from descendants of Zebulon Jacobs and from Zina's second child, Henry Chariton Jacobs, who was born March 22, 1846.

*Orrison Smith*

Todd Compton argues that Fanny Alger was Joseph Smith's first plural wife.<sup>24</sup> The relationship began in Kirtland, Ohio, in 1833; in 1836 she moved with her family to Wayne County, Indiana. When the Alger family continued on to Missouri, she stayed behind, married Solomon Custer, and, according to Solomon's obituary, had nine children.

A Y-chromosome profile was also generated for a Smith lineage suspected to originate from Joseph Smith because of his association with Fanny Alger. Even though Compton reports that Fanny was probably pregnant when she left Kirtland in 1836,<sup>25</sup> there is insufficient historical evidence to show that she had a child by Joseph Smith, or that she already had a child when she married Custer. During this research work, we came in contact with an individual who believed that his ancestor, Orrison Smith, could have been a son of Joseph

---

<sup>21</sup>Van Wagoner, *Mormon Polygamy*, 48–49.

<sup>22</sup>Martha Sonntag Bradley and Mary Brown Firmage Woodward, *Four Zinas: A Story of Mothers and Daughters on the Mormon Frontier* (Salt Lake City: Signature Books, 2000), 112, 114.

<sup>23</sup>Compton, *In Sacred Loneliness*, 72, 81.

<sup>24</sup>*Ibid.*, chap. 1.

<sup>25</sup>According to Compton, there were rumors of a pregnancy but no reports that Fanny actually had a child at this time. *Ibid.*, 35–36. See also Brodie, *No Man Knows My History*, 345.

**TABLE 2**  
**PARLEY P. PRATT'S INFERRED**  
**Y-CHROMOSOME HAPLOTYPE**

<i>Locus</i>	<i>P1</i> <i>Descendant of</i> <i>Parley P. Pratt</i> <i>and Mary Ann Frost</i> <i>through son Moroni</i>	<i>P2</i> <i>Descendant of</i> <i>Parley P. Pratt</i> <i>and Mary Ann Frost</i> <i>through son Moroni</i>	<i>P3</i> <i>Descendant of</i> <i>Parley P. Pratt</i> <i>and Mary Wood</i> <i>through son Helaman</i>	<i>P4</i> <i>Descendant of</i> <i>Parley P. Pratt</i> <i>and Belinda Marden</i> <i>through son Lehi</i>	<i>Parley P. Pratt</i> <i>Inferred Y-ch</i> <i>Haplotype</i> <i>(MRCa)</i>
1 DYS	14	14	14	14	14
2 DYS385	11,12	11,12	11, 12	11, 12	11, 12
3 DYS388	12	12	12	12	12
4 DYS389I	13	13	13	13	13
5 DYS389II	29	29	29	29	29
6 DYS390	23	23	23	23	23
7 DYS391	11	11	11	11	11
8 DYS392	13	13	13	13	13
9 DYS393	13	13	13	13	13
10 DYS426	12	12	12	12	12
11 DYS437	15	15	15	15	15
12 DYS438	12	12	12	12	12
13 DYS439	12	12	12	12	12
14 DYS447	25	25	25	25	25
15 DYS454	10	10	10	10	10
16 DYS455	10	10	10	10	10
17 DYS460	11	11	11	11	11
18 DYS461	11	11	11	11	11
19 DYS462	11	11	11	11	11
20 GAAT1B07	10	10	10	10	10
21 YCAII	19, 23	19, 23	19, 23	19, 23	19, 23
22 Y-GATA-A10	13	13	13	13	13
23 Y-GATA-C4	23	23	23	23	23
24 Y-GATA-H4	11	11	11	11	11

*Note:* We defined Parley P. Pratt's haplotype by DNA obtained from four living direct-line male descendants of Moroni Pratt (P1, P2), Helaman Pratt (P3), and Lehi Pratt (P4). Note that the different mothers do not affect the Y-chromosome transmission. All four haplotypes are identical at all twenty-four loci.

**TABLE 3**  
**HAPLOTYPE COMPARISON BETWEEN**  
**JOSEPH SMITH AND MORONI PRATT**

	<i>Moroni Pratt Y-ch</i>	<i>Joseph Smith Y-ch</i>
DYS19	14	14
DYS385	11, 12	11, 13
DYS388	12	12
DYS389I	13	14
DYS389II	29	30
DYS390	23	24
DYS391	11	11
DYS392	13	14
DYS393	13	13
DYS426	12	12
DYS437	15	15
DYS438	12	12
DYS439	12	12
DYS447	25	25
DYS454	11	11
DYS455	11	11
DYS460	11	11
DYS461	11	11
DYS462	11	11
CGAAT1B07	10	10
YCAII	19, 23	19, 23
Y-GATA-A10	13	13
Y-GATA-C4	23	23
Y-GATA-H4	11	12

Note: The two haplotypes differ at six loci, showing that the Moroni Pratt is not closely related to Joseph Smith.

Smith and Fanny Alger, according to family tradition.<sup>26</sup>

#### COMPARING THE HAPLOTYPES

We obtained a biological sample from volunteers representing

---

<sup>26</sup>Personal communication with the individual tested and with some of his close associates.



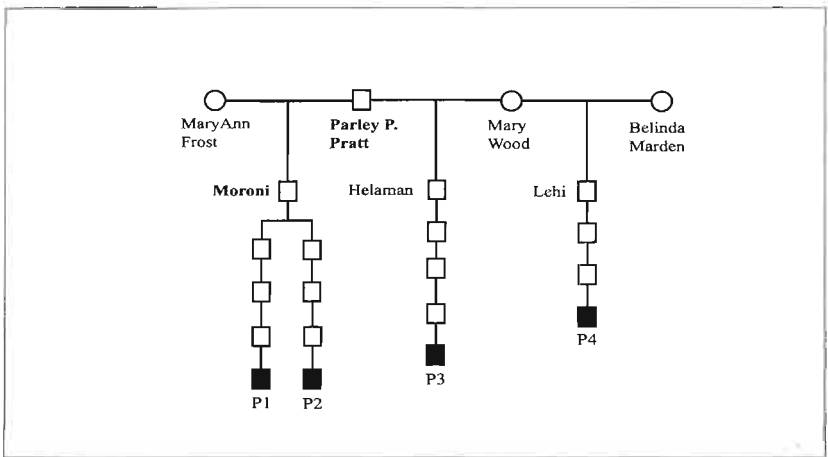

Figure 3. Pedigree chart representing individuals sharing Parley P. Pratt as their most recent common ancestor (MRCA) on their paternal line. Individuals labeled P1 and P2 have Moroni L. Pratt as their MRCA and were tested to reconstruct the Moroni Pratt Y-chromosome haplotype. Individuals labeled P3 and P4 who have Parley P. Pratt as their MRCA were also tested to reconstruct Parley P. Pratt's Y-chromosome haplotype.

each family in the study using a mouthwash rinse to collect cells from inside the cheeks. Using standard laboratory procedures, DNA was separated from the remaining cellular material.<sup>27</sup> Genetic profiles (haplotypes) were then generated for twenty-four markers located along the Y-chromosome<sup>28</sup> using ABI 3700 automated genetic analyzers and processed using ABI Genotyper and GeneScan software (Applied Biosystems, Fullerton, California).

#### *Moroni L. Pratt*

To establish Moroni L. Pratt's genetic ancestry, we constructed Y-chromosome haplotypes for male individuals descending from him (see P1 and P2 in Figure 3 and Table 2). We compared these two Pratt

<sup>27</sup>David J. Walsh et al., "Isolation of Deoxyribonucleic Acid (DNA) from Saliva and Forensic Science Samples Containing Saliva," *Journal of Forensic Sciences* 37 (March 1992): 387-85.

<sup>28</sup>Elena Bosch et al., "High Resolution Y Chromosome Typing: 19 STRs Amplified in Three Multiplex Reactions," *Forensic Science International* 125 (January 2002): 42-51.

haplotypes, which were identical to each other, with the Joseph Smith haplotype at twenty-four loci and found mismatches at six loci. (See Table 3.)

Because the calculated time to the most recent common ancestor with a mismatch of six out of twenty-four loci is approximately 100 generations,<sup>29</sup> Joseph Smith is excluded as Moroni Pratt's biological father. Furthermore, we collected additional DNA samples from Parley's descendants through two other sons and generated an inferred Y-haplotype for Parley P. Pratt similar to the procedure performed for Moroni Pratt. (See P3 and P4 in Figure 3 and Table 2.) The inferred Y-chromosome haplotype of Parley P. and Moroni L. Pratt were identical at all twenty-four loci, which is consistent with Parley's being Moroni's biological father.

To determine the likelihood associated with two individuals sharing the Pratt twenty-four-locus haplotype, we typed 1,180 individuals, mostly of European descent, at twenty-one of the twenty-four loci used to construct inferred Y-haplotypes.<sup>30</sup> Of the 1180 Y-haplotypes, 1,155 were unique,<sup>31</sup> including the inferred Pratt type. Since the inferred Pratt type was unique, the maximum likelihood estimate<sup>32</sup> shows that the probability of two random individuals sharing the inferred Pratt 21-locus haplotype is approximately  $\frac{\ln\left(\frac{1180}{1155}\right)}{1179}$  or 1 out of 55,057.

Since Moroni L. and Parley P. Pratt share identical twenty-four-loci haplotypes, it seems indisputable, in practical terms, that Parley was indeed the biological father of Moroni Pratt.

### *Zebulon Jacobs*

Similarly, we collected and analyzed DNA samples from male de-

---

<sup>29</sup>Walsh, "Estimating the Time to Most Recent Common Ancestor."

<sup>30</sup>We used database samples compiled in advance of this study, which did not include the Y-chromosome markers designated as DYS447, DYS445, and YCAII.

<sup>31</sup>The presence of twenty-five individuals with Y-chromosome haplotypes matching others in the observed subset could be explained by the existence of an undocumented common paternal lineage. There is also a remote possibility of having two unrelated lineages sharing the same set of Y-chromosome markers by chance.

<sup>32</sup>Charles H. Brenner, *Forensic Mathematics*, retrieved April 4, 2005, from <http://dna-view.com>.

scendants of both Zebulon Jacobs and his brother Henry C. Jacobs. Henry C. Jacobs was born in 1846, thus excluding Joseph Smith, who was killed in June of 1844, as his possible father. Furthermore, the identity of Henry C.'s father, Henry Bailey Jacobs, has never been challenged.

We compared the Y-chromosomes of these two individuals at twenty-four loci. All twenty-four were identical, confirming that both children were fathered by the same individual, most likely Henry B. Jacobs. (See Table 4.) These two haplotypes differed at nine loci from Joseph Smith's Y-chromosome, too great a number of variations to consider a paternal relationship.

#### *Orrison Smith*

When we compared the Y-chromosome obtained from a male descendant of Orrison Smith to the Joseph Smith haplotype, we found nine differences between the two. (See Table 5.) Thus, this finding provides strong supportive—but not conclusive—evidence that Orrison Smith was not Joseph Smith's son.

However, since only one descendant of Orrison Smith contributed a DNA sample, we could not infer Orrison's Y-chromosome haplotype. It requires at least two direct male descendants to reconstruct the Y-chromosome haplotype of their most recent common paternal ancestor. A non-paternal event, such as adoption or illegitimacy, in the four generations that separate Orrison Smith from the individual tested could be responsible for the different Y-chromosome haplotype. For this reason, Orrison's Y-chromosome cannot be confidently inferred. To exclude the possibility of a non-paternity event, further DNA sampling from descendants sharing a documented genealogy with Orrison Smith's paternal line is needed.

As displayed in Table 5, the highly significant differences existing among the haplotypes of the three case studies (Moroni Pratt, Zebulon Jacobs, and Orrison Smith), when compared to the Joseph Smith inferred haplotype, identify each one as representing a separate and distinct paternal lineage. Collectively, this study provides each family with additional reliable information for evaluating suspected genealogical relationships.

#### CONCLUSION

This study demonstrates the usefulness of combining traditional genealogical resources with genetic data to illuminate questions of Joseph Smith's possible paternity of children born by plural wives.

**TABLE 4**  
**HAPLOTYPE COMPARISON FOR JOSEPH SMITH AND**  
**DESCENDANTS OF ZEBULON AND HENRY C. JACOBS**

<i>Locus</i>	<i>Descendant of Zebulon Jacobs (b. Jan. 1842)</i>	<i>Descendant of Henry C. Jacobs (b. March 1846)</i>	<i>Joseph Smith Inferred Y-ch. Haplotype</i>
1 DYS19	14	14	14
2 DYS385a, b	11, 14	11, 14	11, 13
3 DYS388	12	12	12
4 DYS389I	13	13	14
5 DYS389II	28	28	30
6 DYS390	22	22	24
7 DYS391	11	11	11
8 DYS392	13	13	14
9 DYS393	13	13	13
10 DYS426	12	12	12
11 DYS437	15	15	15
12 DYS438	12	12	12
13 DYS439	11	11	12
14 DYS447	25	25	25
15 DYS454	11	11	11
16 DYS455	11	11	11
17 DYS460	11	11	11
18 DYS461	11	11	11
19 DYS462	11	11	11
20 GGAAT1B07	9	9	10
21 YCAIIa,b	19, 24	19, 24	19, 23
22 Y-GATA-A10	13	13	13
23 Y-GATA-C4	23	23	23
24 Y-GATA-H4	13	13	12

Note: The inferred Y-chromosome haplotypes for brothers Zebulon and Henry C. Jacobs are identical at all twenty-four loci but different at nine loci from Joseph Smith's inferred haplotype.

**TABLE 5**  
**A COMPARISON OF JOSEPH SMITH'S HAPLOTYPE**  
**WITH THOSE OF THE THREE CASE SAMPLES**

<i>Locus</i>	<i>Moroni L. Pratt's Descendants (2)</i>	<i>Zebulon Jacobs Descendant (1)</i>	<i>Orrison Smith's Descendant (1)</i>	<i>Joseph Smith Inferred Y-ch Haplotype</i>
1 DYS19	14	14	14	14
2 DYS385	<b>11, 12</b>	<b>11, 14</b>	<b>11, 14</b>	11, 13
3 DYS388	12	12	12	12
4 DYS389I	<b>13</b>	<b>13</b>	<b>13</b>	14
5 DYS389II	<b>29</b>	<b>28</b>	<b>29</b>	30
6 DYS390	<b>23</b>	<b>22</b>	<b>25</b>	24
7 DYS391	11	11	<b>12</b>	11
8 DYS392	13	13	<b>13</b>	14
9 DYS393	13	13	13	13
10 DYS426	12	12	12	12
11 DYS437	15	15	<b>14</b>	15
12 DYS438	12	12	12	12
13 DYS439	12	<b>11</b>	12	12
14 DYS447	25	25	<b>24</b>	25
15 DYS454	11	11	11	11
16 DYS455	11	11	11	11
17 DYS460	11	11	11	11
18 DYS461	11	11	11	11
19 DYS462	11	11	11	11
20 GAAT1B07	10	<b>9</b>	10	10
21 YCAII	19, 23	<b>19, 24</b>	19, 23	19, 23
22 Y-GATA-A10	13	13	13	13
23 Y-GATA-C4	23	23	<b>24</b>	23
24 Y-GATA-H4	<b>11</b>	<b>13</b>	12	12

Note: This comparison is between actual Y-chromosome haplotypes for living descendants of Moroni L. Pratt, Zebulon Jacobs, and Orrison Smith and the inferred haplotype of Joseph Smith. Boldface numerals indicate the many differences among the twenty-four loci tested, demonstrating that each haplotype clearly belongs to a separate paternal line.

While some sources report Joseph Smith as the biological father of Moroni Pratt and Zebulon Jacobs through polygamous relationships, genetic testing on the Y-chromosome showed that it is unlikely that Joseph Smith fathered either of them. In addition, the Y-chromosome haplotype for the descendant of Orrison Smith, regarded by some as a possible child of Joseph Smith and Fanny Alger, was significantly different from Joseph Smith's Y-chromosome haplotype and could be confidently excluded as being part of the same lineage.

Genealogical research using the Y-chromosome has recently become popular among family historians for establishing links to common paternal ancestors for individuals sharing the same or similar surnames.<sup>33</sup> This study demonstrates the value of such an approach.

However, Y-chromosome testing alone does not always provide a conclusive answer for determining a particular paternal relationship. One major limitation of this approach is that a long time span can exist between descendants and a most recent common paternal ancestor. Males who share a common paternal ancestor up to ten generations in the past are expected to have identical or very similar Y-chromosome haplotypes at twenty-four loci.<sup>34</sup> Therefore, determining a particular paternity event is difficult without historical documentation that supports a specific ancestor or time associated with the event.<sup>35</sup>

In this study, we can definitely state that Moroni Pratt's father was Parley P. Pratt because the genealogical information harmonized with the genetic results.<sup>36</sup> Similarly, we can confidently exclude Joseph Smith as Zebulon Jacobs's father and identify Henry

---

<sup>33</sup>Jobling, "In the Name of the Father."

<sup>34</sup>Walsh, "Estimating the Time to Most Recent Common Ancestor."

<sup>35</sup>Y-chromosome testing is not to be confused with genetic paternity testing. The use of Y-chromosome testing to prove or disprove the paternity of a child who lived several generations in the past becomes more meaningful when surrounding historical events are also taken into consideration. Paternity testing does not require such documentation and is much more specific than Y-chromosome testing. However, paternity testing can be used only in cases where actual DNA samples for both the alleged parent and the child are available.

<sup>36</sup>The Pratt case is the strongest of the three presented in this paper. In addition to being able to reconstruct and compare Moroni Pratt's Y-chromosome haplotype, we were also able to test additional Pratt lines and reconstruct Parley P. Pratt's Y-chromosome haplotype.

Bailey Jacobs as his and his brother's likely father on the basis of combined genetic and genealogical evidence.<sup>37</sup> We could not identify Orrison Smith's exact paternity, even though the Y-chromosome haplotype of the descendant tested was clearly not from Joseph Smith's paternal line.

Another limitation in using Y-chromosome testing for genealogical purposes is that its application is restricted to males and their paternal lines.<sup>38</sup> This limitation was not an issue with the three cases presented in this study since they dealt with father-son descent. However, to explore more complex genealogical situations involving ancestors from lines other than the paternal one,<sup>39</sup> it will be necessary to examine additional chromosomes of the human genome.<sup>40</sup>

---

<sup>37</sup>With this second case, we could determine only that both Zebulon and Henry C. Jacobs were fathered by the same man. There is no reason to doubt that their father was Henry B. Jacobs. However, we cannot completely exclude from this picture the fact that Zina Huntington, Henry B. Jacobs's wife, was eventually married as well to Brigham Young. While we can confidently exclude Joseph Smith as Zebulon's father, testing a separate Jacobs line (i.e., a male descendant from one of Henry B. Jacobs's brothers, cousins, or uncles) or testing a known descendant of Brigham Young, would eliminate any doubt about Zebulon's true parentage.

<sup>38</sup>Females can use the Y-chromosome genetic testing for their own family history research by asking a male relative who shares their paternal lineage to submit a DNA sample in their stead.

<sup>39</sup>We are currently working on the Josephine Lyon Fisher case, where Y-chromosome testing is of no help since she did not inherit it from her father (either Windsor Lyon or Joseph Smith). This case is much more complex than those presented in this paper. Hundreds of DNA samples from male and female descendants of both Josephine Lyon and Joseph Smith have been collected and are being analyzed with the objective of identifying lineage-specific markers found on the remaining twenty-two chromosomes.

<sup>40</sup>Sorenson Molecular Genealogy Foundation Home Page, retrieved April 4, 2005, from <http://www.smgf.org>.

# LUCY'S IMAGE: A RECENTLY DISCOVERED PHOTOGRAPH OF LUCY MACK SMITH

*Ronald E. Romig and Lachlan Mackay*

LUCY MACK SMITH, MOTHER OF THE MORMON MOVEMENT, played an important role in formative events that led her son Joseph to found an American religious tradition. Her story is inextricably woven into the fabric of the Church's story, and she forcefully advocated the importance of preserving her role in this larger story in her memoir.<sup>1</sup>

We are fortunate that images of certain key participants in the Restoration movement, emerging at the cusp of the photographic era, exist to provide crucial visual clues about their appearance and personality. This is true of many of Joseph Smith's followers such as Oliver Cowdery, David Whitmer, Sidney Rigdon, and Brigham Young.

However, students of the movement have enjoyed access to photographic images of only a handful of the founding Smith family. No known contemporary image of Joseph Smith Sr. exists, either as a graphic, such as a drawing or engraving, or as a photographic delin-

---

RONALD E. ROMIG {romig@cofChrist.org} is archivist of the Community of Christ Archives, Independence, and a specialist in Mormon history in Missouri.

LACHLAN MACKAY {temple@ncweb.com} is director of Community of Christ Historic Sites, Kirtland, Ohio, and an expert on the Kirtland Temple.

<sup>1</sup>Lucy Mack Smith, *Biographical Sketches of Joseph Smith the Prophet, and His Progenitors for Many Generations* (Liverpool: Samuel E. Richards, 1853).





*Hyrum Smith, an engraving created by Frederick Piercy in 1853, not done from life. Courtesy Community of Christ Library-Archives, Independence.*



*A profile of Joseph  
Smith created by  
Sutcliffe Maudsley in  
1842. Courtesy  
Community of Christ  
Library-Archives.*

eation. He is described in one account by a “Mrs. P.,” who claimed to know the family well: “Joseph’s father, the first Patriarch (if not President) of the Mormon ‘Church,’ was very tall; his crooked nose was very prominent; he was a real peasant, without any education. Joseph [Jr.] looked very much like him.”<sup>2</sup>

With the exception of the two details (height and a prominent, crooked nose), this description of Joseph Smith Sr. actually provides little specific understanding of his physical appearance. How tall is “very tall,” for instance? Of the eleven children in the Joseph Sr. and Lucy Smith family, photographs have survived only of three: William, Katharine, and Lucy. Sophronia, the oldest sister, died in 1876, but apparently no known photograph of her has survived. The others (a child who died at birth, Alvin, Hyrum, Joseph Jr., Samuel, Ephraim, and Don Carlos) were all dead by July 1844 before photography or daguerreotypes could capture their likenesses. For example, no photograph of Hyrum Smith has survived. Familiar depictions of Hyrum are based on an 1837 oil portrait by an unknown artist originally painted to hang in the Kirtland Temple and on an engraving by Frederick Piercy created in 1853. Joseph Jr.’s likeness exists in a front-view oil portrait and in a profile painted by Sutcliffe Maudsley in 1842, when he also painted members of the extended Smith family.

Although Mother Smith lived until 1856, she is portrayed only through works of art—all subject to creative interpretation. Two familiar portraits created during Lucy’s lifetime preserve a limited visual record of her appearance, and they alone have informed our understanding of her physical appearance for close to 150 years.

The earlier of the two is a profile image by Sutcliffe Maudsley depicting Lucy in a rocking chair seated below the Book of Abraham facsimile.<sup>3</sup>

The second portrait is a highly detailed and familiar sketch of Lucy, the most enduring depiction of her. Created by Frederick

---

<sup>2</sup>Quoted in Dr. W. Wyl [Wilhelm Wylmetal], *Mormon Portraits, or, The Truth about the Mormon Leaders from 1830 to 1886* (Salt Lake City: Tribune Printing and Publishing Company, 1886), 16.

<sup>3</sup>Noel Barton, an employee of the Genealogical Society of Utah, located the painting in Florida in the 1950s in the possession of Lucy’s granddaughter, Clara Hendel, and acquired it on behalf of the LDS Family and Church Historical Department. It is currently housed in the Museum of Church History and Art in Salt Lake City.

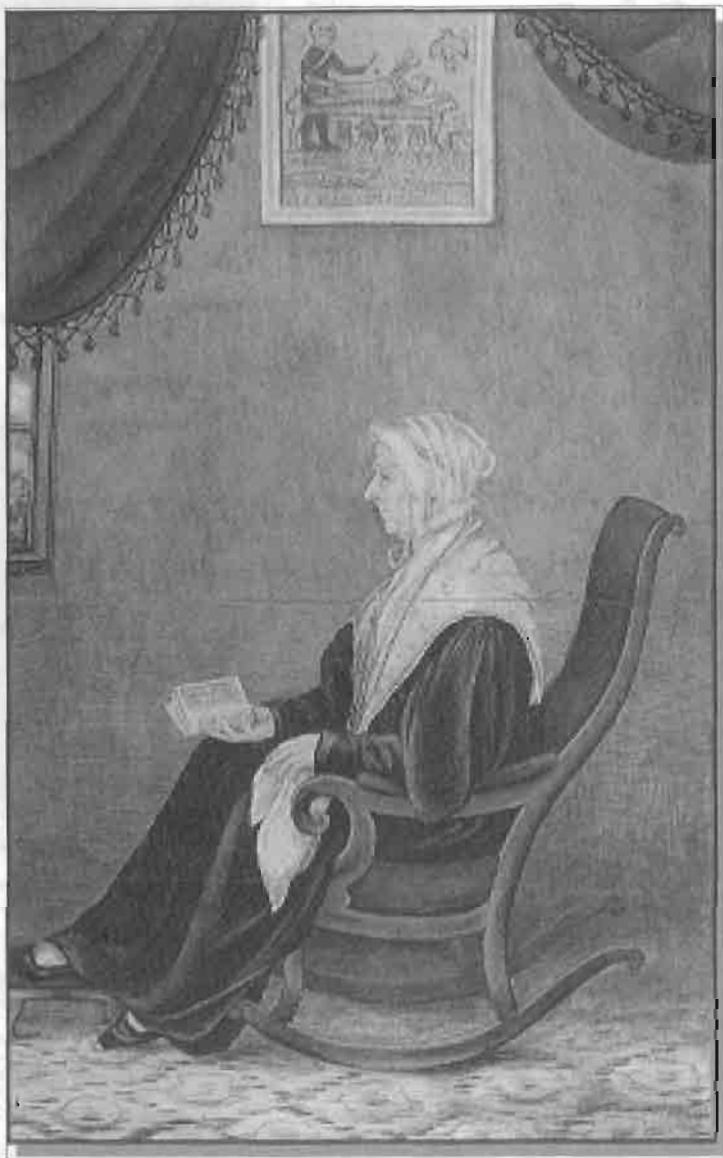

*Lucy Mack Smith, by Sutcliffe Maudsley. This profile image of Lucy in her rocking chair was in the possession of a granddaughter, Clara Hendel, in the 1950s. See Preston Nibley, ed., History of Joseph Smith by His Mother, Lucy Mack Smith (Salt Lake City: Bookcraft, 1956), frontispiece illustration. Courtesy of the Museum of Church History and Art.*



*Lucy Mack Smith by Frederick Piercy, 1853, published in his From Liverpool to Great Salt Lake Valley, 1855.*

Piercy, he reproduced it as an engraving in *Route from Liverpool to Great Salt Lake Valley*, where he also described his visit to Lucy in 1853:

While in Nauvoo I lodged at the Nauvoo Mansion, formerly the residence of Joseph Smith, and now occupied by his mother, his widow and her family. I could not fail to regard the old lady with great interest. Considering her age and afflictions, she, at that time, retained her faculties to a remarkable degree. She spoke very freely of her sons, and, with tears in her eyes, and every other symptom of earnestness, vindicated their reputations for virtue and truth. During my two visits I was able to take her portrait, and the portraits of two of her grandsons also.<sup>4</sup>

An oil portrait recently donated to Brigham Young University Special Collections by Eldred G. Smith and Hortense Child Smith is among known interpretations of Lucy. This stylized painting by an unknown artist is based on Piercy's work and copies Piercy's setting, but depicts a more youthful Lucy while retaining 1853 period clothing.

Although there is widespread interest in Lucy Mack Smith throughout the Mormon movement—perpetuated by her book, versions of which have been in print constantly since 1853—no recognized photographic image of her has been identified, until now. We believe such an image exists and was preserved by her descendants but has been identified with some measure of certainty only recently.

The story of the photograph begins at some as yet unspecified date about 1845, but the story of its discovery begins a century later during the 1950s. Sidney Moore, an antiques dealer and artist (now deceased) from Independence, Missouri, assisted the RLDS Church from 1954 until 1958 with the historical restoration of the Smith Homestead and Mansion House in Nauvoo, Illinois.<sup>5</sup> During this time, Moore discovered an old oil painting in the Mansion House attic. The portrait, undated and unsigned, depicts an elderly woman wearing a black dress and day cap.

The portrait was—and remains—in poor condition and any at-

---

<sup>4</sup>James Lindforth, ed., *Route from Liverpool to Great Salt Lake Valley* (Liverpool: Franklin D. Richards, 1855), 63–64.

<sup>5</sup>The 2000 RLDS World Conference officially changed the name of the Reorganized Church of Jesus Christ of Latter Day Saints to the Community of Christ, effective in April 2001.



*Lucy Mack Smith, portrait by unknown artist based on Piercy's engraving in Route from Liverpool to Great Salt Lake Valley.*



*An oil painting in fragile condition found by Sidney Moore in the Mansion House, Nauvoo, Illinois, ca. 1954-58.*



tempted restoration would be costly. Moore, who had conservator skills, moved the canvas to his shop in Independence and hoped to restore it but at some point realized that the portrait needed more repairs than he could provide. His interest lapsed, so he stored the painting. As years passed, Moore's artistic reputation grew and he had even less time to undertake such a project. In 1991, Moore returned the painting to the Restoration Trail Foundation (RTF) office in Independence, Missouri, explained the circumstances of finding it to the RTF Office Manager, Anina Mackay (now Luff), who was, coincidentally, Lachlan's mother, and expressed his opinion that the subject was a member of the Smith family. Because of the portrait's fragility, RTF Executive Director Bill Knapp arranged for a professional to photograph the painting. Around 1992 the painting was transferred to the care of the Community of Christ Headquarters Museum where it is currently stored with other Community of Christ Museum visual materials.

The discovery of the portrait was one serendipitous event. Another occurred shortly after the passing of Lynn Smith in June 1992. Lynn was the great-grandson of Joseph Jr. and Emma Hale Smith, the son of Elbert A. Smith and Clara Cochran Smith. Elbert was the only child of David Hyrum Smith, the eleventh and last child of Joseph and Emma Hale Smith.<sup>6</sup> David was born in November 1844, five months after Joseph's assassination. Raised by his mother and her second husband, Louis Bidamon, in Nauvoo with his three surviving brothers (Joseph III, Frederick, and Alexander) and his adopted sister (Julia Murdock Smith), David had artistic and poetic gifts. He affiliated with the Reorganized Church of Jesus Christ of Latter Day Saints when it was organized after 1860 with Joseph III as its first president. David did extensive missionary work on behalf of the RLDS Church, traveling to Utah and many other places.

He married Clara Hartshorn in 1870, and they had one child, Elbert. Clara and Elbert remained in Nauvoo, where they resided in the Mansion House. During the 1870s, David experienced episodes of mental instability. At times Clara returned for extended stays at her parents' home in Sandwich, Illinois, and moved with them in 1876 when they relocated to Marathon, in northwestern Iowa. On January 22, 1877, Joseph Smith III sadly reported that he had been forced to

---

<sup>6</sup>Elbert A. Smith, *On Memory's Beam* (Independence: Herald Publishing House, 1956), 208.

commit David to the Illinois State Hospital for the Insane in Elgin.<sup>7</sup> Clara had faith that he would eventually recover, but he never did. Meanwhile, around 1890 Alexander bought out David's interest in the Mansion House. In 1892, Clara Hartshorn Smith and Elbert moved to Lamoni, Iowa, and enjoyed a fuller community with the main body of the Church.<sup>8</sup>

In 1895, Elbert married Clara Cochran, and they had two sons, Ronald, born in 1902, and Lynn, born in 1911. They also made a home for Elbert's mother, who had been widowed when David Hyrum died, still institutionalized, in 1904. In 1918, the family moved to Independence from Lamoni, Iowa. Elbert's mother lived with the family on West Walnut Street until her death on August 9, 1926.<sup>9</sup> Lynn married in 1937; he and his wife, Lorene, occupied the family home after the passing of his parents.

Within months of the transfer of the deteriorated "Lucy Smith" portrait to the community of Christ, a related image surfaced. At the time of Lynn's death, Lorene Smith and her cousin, Anina Mackay, worked with the Community of Christ Archives to preserve many significant Smith family artifacts, documents, and photographs in the family home. Lachlan Mackay helped identify Smith family artifacts to be accessioned into the archives. During this process, he was sorting through a trunk of Clara Hartshorn Smith's possessions in the attic of Lynn Smith's home when he encountered a packet of old photographs labeled "Mother Smith's Pictures." The images in this envelope, some unlabeled, were all of members of the Smith family. With considerable shock, Lachlan realized that one of the unlabeled photographs bore a remarkable similarity to the painting Sidney Moore had discovered in the Mansion House attic more than thirty-five years earlier and which he had seen just months earlier in the Church's possession. Lachlan believed the person in the photograph was the same

---

<sup>7</sup>Joseph Smith III, Letter to Jason W. Briggs, January 22, 1877, Joseph Smith III Letter Books, P6, Letter Book 1, p. 76, Community of Christ Library-Archives, Independence.

<sup>8</sup>Ibid., 98. For additional information on David Hyrum Smith, see Valeen Tippetts Avery, *From Mission to Madness: Last Son of the Mormon Prophet* (Urbana: University of Illinois Press, 1998); and Linda King Newell and Valeen Tippetts Avery, *Mormon Enigma: Emma Hale Smith, Prophet's Wife, "Elect lady," Polygamy's Foe, 1804-1879* (New York: Doubleday, 1984).

<sup>9</sup>Elbert Smith, *On Memory's Beam*, 208.



*Rectangular photograph of a round daguerreian button, Community of Christ Archives. The oil painting found by Sidney Moore was produced from this photograph.*

person portrayed in the fragile portrait painting and promptly mobilized a team to investigate that possibility.

Members of the extended Smith family could shed no light on the provenance of the photograph and could not remember ever having seen the packet of photographs.

The photograph is an early albumin *carte de visite*, copied from

an earlier circular image.<sup>10</sup> The image in the *carte de visite* appears to be a photograph of a daguerreian button. Such buttons were popular jewelry and among “some of the hottest novelty items” of the period 1845–55.<sup>11</sup> Customers could either purchase daguerreian jewelry from the local daguerreotype artist or it could be custom made by a jeweler. Daguerreian buttons were typically worn as a remembrance of a loved one or as a way to acknowledge that one was in mourning.<sup>12</sup> The jewelry was available in a wide variety of forms. Buttons “exist[ed] . . . in various sizes indicating a variety of uses.”<sup>13</sup> Because this is only a photographic image of the original, the actual scale of the original artifact is uncertain, but known examples are about the size of a common brooch or fifty-cent piece.

Our initial excitement over the discovery was tempered by the thought that the image could be a photograph of the painting itself. However, a careful side-by-side comparison of the two conducted soon after the discovery suggests otherwise. Differences in the treatment of fine detail, including the part in the subject's hair, the highlights, and the brooch at the base of the throat reveal that the photograph was not taken from the oil portrait but that the oil portrait was actually painted from the photograph. Fine details exist in the photos that are stylized in the painting.

Indisputably, both the oil portrait and the photograph depict the same woman. Furthermore, comparisons between this portrait and the Frederick Piercy etching of Lucy Mack Smith reveal significant resemblances, adding further weight to the identification of the image as that of Lucy Mack Smith.

The coincidence of these two images being found in locations associated with Smith family descendants is a strong indication that this individual is a significant member of the Smith family. As already noted, the Mansion House remained in the hands of the Smith family until the early 1900s. It is possible that at some point the canvas was

---

<sup>10</sup>A daguerreotype plate was both the negative and positive. Duplicates could be made only by photographing the original. A *carte de visite* is about 2½ by 3½ inches in size. Using such photographic images became popular, and they often served as a personalized visiting card.

<sup>11</sup>Larry West and Patricia Abbott, “Daguerreian Jewelry: Popular in Its Day,” *The Daguerreian Annual*, 1990, 136.

<sup>12</sup>*Ibid.*, 139.

<sup>13</sup>*Ibid.*, 140.

placed in the attic of the Mansion House, where it remained until Moore found it in the 1950s.

Thus, geographical location and proximity to Lucy Mack Smith's direct descendants are positive indications that the portrait is of her. But without written documentation or the memory of a living descendant, how do photographic historians construct a case in such situations? Fortunately, the treatment of historic photographs as documents is gaining in credibility at this point, and we were able to draw on many reliable techniques and precedents in our investigation.

Our next step was to compare the image with that of known descendants. Lucy was born almost a year before the birth of the United States in 1775 (Lucy misdated her own birth year as 1776 in her autobiography) and would have been in her late seventies when this image was captured. Of course we immediately checked to see if the image could have been one of Lucy's daughters. Photographs of Katharine and daughter Lucy show little resemblance, and Sophronia, born in 1803, can be effectively ruled out because of her age.<sup>14</sup> If the photograph is a daguerreian button, it dates from between 1845 and 1855. Sophronia would have been no older than fifty-two at best, and the woman in the image is much older. Lucy Mack Smith is the best and most likely candidate.

Next, we did a comparison of facial features to portraits of Lucy's descendants. (Because the woman in the photograph is seated and fully clothed, little can be determined about height, weight, arm length, or other body features.) Family comparisons, while insufficient alone to prove or disprove these images to be Lucy Mack Smith, are encouraging. The features of the woman in the button photograph are consistent with quite distinctive characteristics present also in her children—William B. Smith, Lucy Millikin, and Katharine Salisbury—especially the deep-set eyes. Other attributes shared by the woman in the portrait, William, Katharine, and Lucy Millikin, include a narrowing of the head at the temples, a high forehead, and the broadened oblong shape of the face as a whole. These characteristics, plus the existence of the oil portrait found in the Mansion House, provide persuasive evidence, for us, that this woman is Lucy Mack Smith.

An interesting description of Lucy was recorded by Eudocia

---

<sup>14</sup>Mary Audentia Smith Anderson, *Ancestry and Posterity of Joseph Smith* (Independence: Herald Publishing House, 1929), 74.

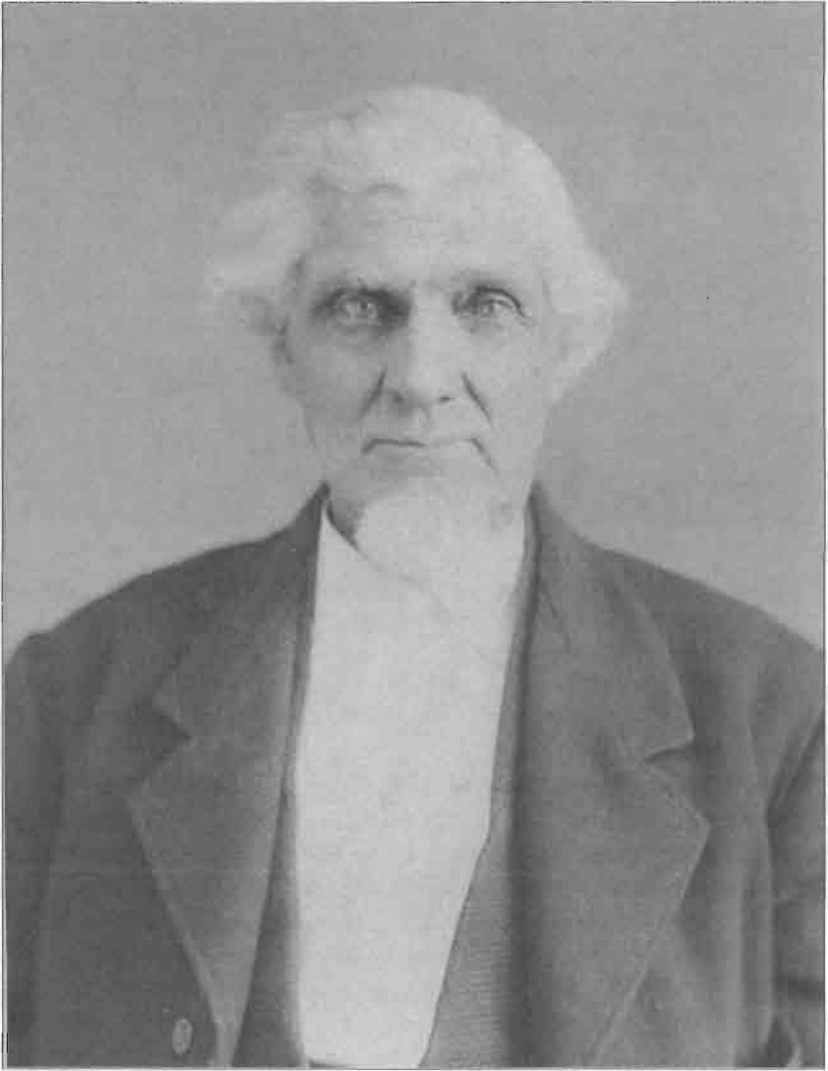

*William B. Smith, son of Lucy Mack Smith, ca. 1885, when he would have been seventy-four. Courtesy Community of Christ Library-Archives.*



*Katharine Smith Salisbury (left) and Lucy Smith Millikin, daughters of Lucy Mack Smith, ca. 1880s, when they would have been in their sixties. Courtesy Community of Christ Archives.*

Baldwin Marsh. Marsh was raised near Carthage, Illinois, and visited Nauvoo on an outing with family members late in 1843 or in 1844, prior to Joseph's death, when she would have been about fifteen. Some years later, she penned a reminiscence: "[We] dined at the Mansion House Smiths large Hotel. After dinner we were told that in an adjoining room some Egyptian Mummies were exhibited for a small sum—Some of the party expressing a wish to see them, we found them presided over by the mother of the Prophet, a trim looking old lady in black silk gown and a white cap and kerchief."<sup>15</sup>

Lucy's "trimness" is consistent with other descriptions of her as petite—barely five feet tall, although her husband and apparently all of her sons topped more than six feet, like Joseph Sr. Her black dress showed she was in mourning for her husband, Joseph Sr., who had

---

<sup>15</sup>Eudocia Baldwin Marsh, "Mormons in Hancock County: A Reminiscence," *Journal of the Illinois State Historical Society* 64 (Spring 1971): 22–65.

died in September 1840.<sup>16</sup> Although younger widows usually laid aside mourning after a year, older widows sometimes wore black for the remainder of their lives. However, Lucy had suffered other bereavements in her immediate family: her son, Don Carlos, had died in August 1841 followed by grandson Hyrum Jr. in September 1841. Daughter-in-law Emma gave birth to children in 1841 and 1842 who died shortly after birth.

In addition to the color of the dress, we also examined the style of the clothing in the daguerreotype and painting. Marsh's description of the white cap and kerchief also resemble details in the button-*portrait*. Day caps with lappets, as seen in the photograph, reached the height of their popularity in the 1840s and then became less common in the 1850s. The tailored white collar was also common in the 1840s, although lace collars were also popular.

In short, the external evidence (provenance as far as it can be traced, possession in the family, and place of discovery) can be reinforced by internal evidence (resemblance of facial features to Lucy's children at or about the same age, clothing consistent with the period, and the piece of daguerreian jewelry typical of a single decade of Lucy's life). Furthermore, no piece of internal or external evidence contradicts identifying the woman in the photograph and the complementary oil painting as being Lucy Mack Smith. Although it is not currently feasible to restore the oil painting, we consider it to be part of our Smith Family collection and welcome the emergence of other evidence that would either challenge or further clarify this conclusion: that this is the only known photograph of Lucy Mack Smith.

---

<sup>16</sup>Carma DeJong Anderson, a specialist in nineteenth-century Mormon dress, interviewed by telephone by Lachlan Mackay, May 6, 1993.



# EYES ON “THE WHOLE EUROPEAN WORLD”: MORMON OBSERVERS OF THE 1848 REVOLUTIONS

*Craig Livingston*

## THE ECUMENICAL BANNER

IN 1847 MORMONS YEARNED FOR REDEMPTION. On Ensign Peak overlooking the Salt Lake Valley flew a banner referred to as the “Flag of the Kingdom of God.”<sup>1</sup>In the revolutionary tradition, writes French historian Mona Ozouf, display of ensigns and liberty poles was a militant act—a symbolic leaving of the old world and “wel-

---

CRAIG LIVINGSTON {craigl@nhmccd.edu} took his master’s degree from Brigham Young University (1991) and wrote his dissertation at Temple University, “From Above and Below: The Mormon Embrace of Revolution, 1840–1940” (2002). He presented a paper about the supportive response of LDS authorities to the Mexican Revolution (1911–19) at the Mormon History Association annual meeting at Tucson, Arizona, in 2002. Craig is a full-time history instructor at Montgomery College, Conroe, Texas.

<sup>1</sup>D. Michael Quinn, “The Flag of the Kingdom of God,” *BYU Studies* 41 (Autumn 1973): 105–14; Ronald W. Walker, “‘A Banner is Unfurled’: Mormonism’s Ensign Peak,” *Dialogue: A Journal of Mormon Thought* 26 (Winter 1993): 71–91. Samuel Brannan’s ship *Brooklyn* flew a white flag of a crowned woman surrounded by twelve red stars. See Will Bagley, *Scoundrel’s Tale: The Samuel Brannan Papers* (Spokane, Wash.: Arthur H. Clark, 1999), 154–48. Brannan’s flag bears striking resemblance to the iconogra-

coming the birth of the new."<sup>2</sup> Driven into exile by Illinoisans who feared that Joseph Smith's theocracy would impair the individualism they believed essential to free voting in a republican society, Mormons streamed to the Rockies to nurse their ecumenical visions.<sup>3</sup> In the mountain valleys, they waited for the catalyst that would mark the new beginning. It came quickly.

In 1848 Europe exploded in revolution. The shaking of the European order heralded to some high-ranking Mormons that the world was about to undergo major transformation. Apostle Wilford Woodruff, who a year before was skirmishing with Indians in Wyoming, penned from Boston: "Our eyes are turned towards . . . the whole European world."<sup>4</sup>

Woodruff was not alone in his transatlantic orientation. Other Mormons, here identified as "observers," rhapsodized the revolutions of 1848, leaving behind a body of manuscripts, diary accounts, and published works about events far away from Latter-day Saint priorities in the Great Basin. Chief among these observers were three apostles, three mission presidents, a Scottish poet, and a half-dozen missionaries and members. They were united by a sense that it was their duty to make their observations a matter of Church record.

Mormon observers made the revolutions of 1848 fit their worldview in three different respects. First—and ironically, given the

---

phy of the French Revolution in Joan B. Landes, *Visualizing the Nation: Gender Representation, and Revolution in Eighteenth Century France* (Ithaca: Cornell University Press, 2001), 51, 150–51, 160–61.

<sup>2</sup>Mona Ozouf, *Festivals of the French Revolution*, translated by Alan Sheridan (Cambridge, Mass.: Harvard University Press, 1988), 254–55. Mormon liberty poles raised during the early years in Utah seemed to have had this meaning in B. H. Roberts, *A Comprehensive History of the Church of Jesus Christ of Latter-day Saints*, 6 vols. (Salt Lake City: Deseret Book, 1930), 3:275, 319 note 25, 375, 493 note 37. On the origins of revolutionary flags, see James Billington, *Fire in the Minds of Men: The Origins of the Revolutionary Faith* (New York: Basic Books, 1980), 101, 159, 346.

<sup>3</sup>John E. Hallwas, "Mormon Nauvoo from a Non-Mormon Perspective," in *Kingdom on the Mississippi Revisited: Nauvoo in Mormon History*, edited by Roger D. Launius and John E. Hallwas (Urbana: University of Illinois Press, 1996), 160–80.

<sup>4</sup>Wilford Woodruff, Letter to Orson Spencer, August 21, 1848, *Milennial Star* 10 (October 15, 1848): 317.

negative Mormon experience in the United States—the observers believed that the rise of republics legitimated the overthrow of kings. Second, and closely related, representative government would promote religious toleration. Membership rolls would swell, and those who wished could emigrate to the gathering place in Utah. Furthermore, liberalized legal codes would free the Jews. No longer fettered by prejudicial laws, Jews would be allowed to fulfill their prophetic role in Palestine. Third, the revolutions vented the anger of oppressed peoples. To the Mormon observers, the rulers and ministers of Europe stood as proxy for American politicians who had forced the Saints—vicars of the future world government—to move west. From a socioeconomic perspective, bad working conditions and low wages pricked the observers' sense of compassion. The factory owners of the emerging industrial order deserved their chastisement.

The observers bent their millennial expectations to match the political developments of the revolutions. Mormons with eyes on Europe in 1848 found themselves between two end-of-time variations. One was the move west where the Saints awaited the millennium at the edge of the world. The other preached a progressive eschatology. Apostle Orson Pratt praised the secular “Reformers, Socialists, Communists, [and] Philosophers” who were challenging the European political and economic status quo. He also called attention to outspoken Protestants, whom Pratt saw as renewing their confidence in Christ as an “eminent and illustrious reformer, teacher, prophet, [and] brother.”<sup>5</sup>

Pratt's hint of convergence with European thinkers suggests a Mormon subtext to the bigger event: Man, acting as God's agent, might destroy religious, social, and political monopolies. Once these barriers were removed, man himself might provide the genesis of world unification. Pratt, in other words, offered a different narrative. Instead of a world deteriorating in dynastic enslavement, spiritual darkness, and physical destitution that could be cleansed only by the universal destruction promised in the Second Coming of Christ, he perceived an uplifting revolution from below. Pratt saw the people taking matters into their own hands and was quite willing to see the opening act of the drama played out in revolutionary violence.

For the Mormon observers, victory was coming, now, in the

---

<sup>5</sup>Orson Pratt, “Building the Temple at Jerusalem,” *Millennial Star* 11 (March 1, 1849): 69.

world, in calendar time, and by human hands. In the crucible of revolution, the people would smelt dynastic privilege and factory exploitation then reforge society in a spiritual union of peace. Faith that the revolutionary wave represented the will of God inoculated Mormon hopefuls against the anxiety induced by the violent restructuring of existing social and political forms. The destruction of the monarchical and industrial orders, the rise of republicanism, and the opening of the millennial era appeared to be preparing the world for redemption. At a stroke in 1848, Pratt's European revolutionists and religionists were depicting a world getting better, not worse, before the millennium.

The observers picked up this narrative and recast it for a Mormon audience in the format of revealed history. For a brief time, the priesthood secrets introduced in Nauvoo and dark visions of apocalyptic destruction yielded to the rapture of popular revolt. But in standing so high on a pinnacle of hope, the observers' disappointment when their heady expectations failed would be severe.

#### COURSE OF THE REVOLUTIONS, 1848-51

The explosion of 1848 had been building since Waterloo. Political movements increasingly challenged the dynastic formulas that the ministers of the 1815 Congress of Vienna had foisted on Europe in the wake of the Napoleonic wars. Industrialization was growing more exploitive. Twenty-five years of economic change and low agricultural yields in 1845 and 1846 had produced unsettled conditions by 1848. Economic and political distress climaxed in France. On February 24, Parisian magistrates suppressed a workers' political banquet. The people, joined by the National Guards, revolted. King Louis-Phillip abdicated, and four days later the provisional government proclaimed the Second Republic.<sup>6</sup>

The fall of the French monarchy triggered urban fighting, separatist movements, and political awakenings all over Europe. Nationalists and intellectuals dominated the revolutions, supported by

---

<sup>6</sup>On the mid-century European revolutions see Jonathan Sperber, *The European Revolutions, 1848-1851* (New York: Cambridge University Press, 1993); R. J. Evans, and Hartmut Pogge von Strandmann, eds., *The Revolutions in Europe, 1848-1849* (New York: Oxford University Press, 2000); Raymond Postgate, *The Story of a Year: 1848* (New York: Oxford University Press, 1956).

peasants, radicals, students, and workers. The first phase of the revolutions between February and November 1848 produced assorted constitutional monarchies, national assemblies, and republics in France, Prussia, the Italian states, the Hapsburg Empire, and Poland. Revolution on the continent of Europe also inspired reformers in Great Britain. However, the revolutionaries failed to establish permanent governments. The forces of reaction began to regroup in June 1848. By the summer of 1849 the counter-revolution was completed.

But its beginnings were heady. In March 1848 the provisional government of France charged the Luxembourg Commission to reform labor laws. Under the influence of radical democrats—or “Red Republicans”—National Workshops headed by Louis Blanc were set up to employ artisans and workers. Political clubs organized throughout France as the people felt energized by the nation’s resurrected revolutionary heritage.

Revolution also hit the Prussian capital of Berlin in early March. Unnerved by the street fighting, Frederick Wilhelm IV acceded to a constitution. In May representatives of the German states met in Frankfurt to draft a formula for a greater Germany. The prospect of a unified nation was greeted with such anticipation that Catholics, Protestants, and Jews embraced in the Rhineland city of Mainz. In Cologne Friederich Engels exhorted 8,000 people to demand a republic under the red flag.<sup>7</sup>

Centrifugal forces threatened the Hapsburg Empire, which covered vast tracts in central and eastern Europe. In March 1848, Klemens von Metternich, the personification of dynastic rule, fled from Vienna. Two months later in May, the imperial court abandoned the capital for Innsbruck. The temporary eclipse of Hapsburg fortunes whetted nationalist aspirations throughout the empire. Slovaks, Serbs, and Romanians asserted their autonomy in mass rallies. Hungary elected a national assembly. When threatened in September by armies still under imperial control, the Hungarians, led by the charismatic Louis Kossuth, voted for armed resistance. In October Hungarian generals pushed Austrian armies back up the Danube toward Vienna. From Budapest and Paris came calls for the restitution of Poland. In March 1848 a Polish National Committee was established in Cracow. Throughout east Europe peasants ignored baronial rights

---

<sup>7</sup>Sperber, *The European Revolutions, 1848–1851*, 116, 157.

and invaded the forests to hunt, pick berries, and gather wood.

Great Britain escaped generalized fighting but tensions ran high. In April the Chartists, regarded as the most democratic force in Europe, petitioned Parliament for broader voting rights. The police contained the crowds; but through the summer of 1848, the movement's left wing conspired to continue the struggle. The potato famine made Ireland a nightmare. Making the suffering more abysmal was the British government's devotion to supply and demand dogma that militated against direct relief. Half of Ireland's 8 million either starved to death or migrated, squeezed out by Anglo landlords. In June 1848, Young Ireland affiliates staged a rebellion. The uprising failed, but agitation continued into 1849.

Dramatic events also scorched the states that form modern Italy. In February, constitutional monarchies formed in Piedmont-Savoy and Tuscany. Milan and Venice declared independence from the Hapsburg Empire in March. The "Kingdom of the Two Sicilies" split. King Ferdinand of the Spanish Bourbon royal house retained control of Naples after an uprising in May but was forced to accept a parliament. Insurrectionists on the island of Sicily, however, ceded from the Neapolitan union completely. In November 1848 radicals drove Pope Pius IX from Rome after he reneged on a promise to accept a constitution for the Papal States. The "Red Shirts" commanded by Giuseppe Garibaldi, along with Genoese Mazzini and other Italian nationalists, prepared to defend the Roman republic against papal retaliation.

The counter-revolution began in June 1848. Paris workers, frustrated when premature elections returned a government that abolished the Luxembourg Commission and that began to dismantle the public works programs, instigated the "June Days" insurrection. The French army routed the insurgents in three days of bloody street fighting.

Hapsburg and Hohenzollern power also revived. In June, Prince Alfred Windischgrätz of the Austrian army suppressed the Slav Congress in Prague. In November 1848 General Joseph Radetzky recaptured Vienna using artillery bombardments and infantry assaults second in intensity only to the counterattack on Paris. Hapsburg troops executed Robert Blum, the Frankfurt Assembly's well-known democrat. The crushing of constitutionalism on the barricades of Vienna wrecked pan-German aspirations. Frederick William IV refused the crown of a united Germany; and in June 1849,

Prussian troops scattered the liberal-minded Frankfurt Assembly.

One by one the Italian states succumbed to royalist forces. In the south, King Ferdinand dissolved the Neapolitan parliament in March 1849. In May, Bourbon troops defeated the Sicilian rebels. Radetzky smashed the Piedmontese at the Battle of Novara on March 23, 1849. By May Hapsburg regiments had occupied Milan. Venice surrendered in August after a three-month bombardment. France, concerned that Hapsburg victories in north Italy would upset the balance of power, landed troops to restore papal authority in Rome. The republicans resisted, but the city fell July 3. Garibaldi fled to America.

Nor could Romania, Poland, and Hungary survive the conservative onslaught. Nicholas I of Russia, anxious to shield his feudalistic state against modern ideas, invaded east Europe at Austria's request. Cracow fell in May 1849. By August, Russian and Austrian forces had subjugated Romania and Hungary.

The ironic denouement occurred in France. In the lull that followed the June Days insurrection, revolutionaries waited for another chance, but Napoleon III seized power from the National Assembly on December 2, 1851. Two years later he declared himself Emperor of the French.

### THE AMERICAN RESPONSE

The American response in general, driven by reform-minded Whigs and "Young America" democrats who advocated the spread of American ideals across North America, welcomed news of sister republics forming in Europe. President James K. Polk recognized the new French government but gave only moral assurances to the others.<sup>8</sup>

By mid-1849 public ardor had cooled. The euphoric reception given to Hungarian nationalist Louis Kossuth when he landed in New York City on December 5, 1851, briefly rekindled the initial sentiment; but northern enchantment with the Hungarian struggle did

---

<sup>8</sup>For the American response, see Merle E. Curti, "The Impact of the Revolutions of 1848 on American Thought," *Proceedings of the American Philosophical Society* 93 (1949): 209–15; John Gerow Gazley, *American Opinion of German Unification, 1848–1871*, Studies in History, Economics, and Public Law (New York: Columbia, 1926); Emiliana P. Noether, "The American Response to the 1848 Revolutions in Rome and Budapest," *Consortium on Revolutionary Europe, 1750–1850: Proceedings* 15 (1985): 379–97; Richard

not endure. Kossuth declined to endorse the antislavery crusade to avoid sidelining his own cause.<sup>9</sup> American churches detected delayed fulfillment of the Protestant Reformation in the overthrow of Pius IX but otherwise showed little interest in the sociopolitical significance of the revolutionary wave.<sup>10</sup> A recent scholar concludes that “American interest in the Revolutions of 1848” was “transitory . . . and superficial.”<sup>11</sup>

### MORMON SOURCES AND MORMON OBSERVERS

While in some respects the Mormon observers reflected the opinions of territorial expansionists, reformers, and church ministers, they nevertheless outdistanced all three.<sup>12</sup> This paper measures the distance Mormon thought went by focusing on Mormons assigned to posts that enabled them to track the revolutions, record their thoughts, and address them publicly. Working class diaries and periodicals of the 1840s focused mostly on daily concerns, with only rare forays into political and social commentary, and converts to Mor-

---

C. Rohrs, “American Critics of the French Revolution of 1848,” *Journal of the Early Republic* 14, no. 3 (1994): 359–77; Timothy M. Roberts and Daniel W. Howe, “The United States and the Revolutions of 1848,” in *The Revolutions in Europe, 1848–1849*, edited by R. J. Evans and Hartmut Pogge von Strandmann (New York: Oxford University Press, 2000), 157–79.

<sup>9</sup>Donald S. Spencer, *Louis Kossuth and the Young America: A Study of Sectionalism and Foreign Policy, 1848–1852* (Columbus: University of Missouri Press, 1977), 14–18.

<sup>10</sup>Roberts and Howe, “The United States and the Revolutions of 1848,” 165–66; Theodore Dwight Bozeman, “Inductive and Deductive Politics: Science and Society in Antebellum Presbyterian Thought,” *Journal of American History* 64, no. 3 (1977): 704–22.

<sup>11</sup>Roberts and Howe, “The United States and the Revolutions of 1848,” 173.

<sup>12</sup>On Mormon sympathy with Young America, see Robert B. Flanders, *Nauvoo: Kingdom on the Mississippi* (Urbana: University of Illinois Press, 1965), 212. Young America newspaperman James Gordon Bennett, editor of the *New York Herald* and Mormon sympathizer, wrote several articles supporting the European revolutions, many of which were reprinted in the *Millennial Star*: e.g., “Extracts from Mr. Bennett’s Letters from Europe,” 9 (July 1, 1847): 197–98; “The Foreign Policy of France—the Final Great Struggle,” 10 (July 15, 1848): 209–11.



monism were no exception.<sup>13</sup> Furthermore, some Mormon officials dismissed the revolutions. Apostle Willard Richards regarded them as just “anarchy” and “commotion,” and fellow apostle John Taylor believed them completely misguided.<sup>14</sup> But for those who saw them as progressive millennialism in action, commentary was euphoric and voluminous.

One observer was William Ivers Appleby (1811–70), president of the Eastern States Mission from February 1847 until he went west in May 1849. Although Appleby was never a polygamist, Church leaders trusted him with important callings. Shortly after his arrival in the Salt Lake Valley, he was appointed regent for the University of Deseret (University of Utah) and was elected to the territorial legislature. From 1856 to 1857, Appleby served another mission, managing John Taylor’s *The Mormon* in New York.<sup>15</sup> The dispatches arriving on packet steamers from Europe aroused Appleby: “There probably never was a period in the history of human affairs in which the movements of the Great Powers of the earth were invested with so much grandeur and solemnity as at the present moment,” he wrote in April 1848.<sup>16</sup> To commemorate the drama for future generations Appleby began to write “History of the Signs of the Times Benefiting the Church of the Latter-day Saints,” a manuscript he hoped would be

---

<sup>13</sup>John Fletcher Clews Harrison, “The Popular History of Early Victorian Britain: A Mormon Contribution,” *Journal of Mormon History* 14 (1988): 3–15; Billington, *Fire in the Minds of Men*, 335.

<sup>14</sup>Willard Richards, Letter, May 16, 1848, *Millennial Star* 11, no. 1 (January 1, 1849): 8; John Taylor, *The Government of God* (Liverpool: S. W. Richards, 1852), 24–25. See also “John Taylor’s Conference Sermon,” *Journal History*, April 8, 1853, 11.

<sup>15</sup>Andrew Jenson, ed., *Latter-day Saint Biographical Sketches of Prominent Men and Women in the Church of Jesus Christ of Latter-day Saints*, 4 vols. (Salt Lake City: originally published by A. J. Memorial Foundation, 1901, 1914, 1920, 1936; photo reproduction, Salt Lake City: Western Epics, 1971), 4:330–31; Obituary of William Ivers Appleby, *Deseret Evening News*, May 20, 1870.

<sup>16</sup>William I. Appleby, “History of the Signs of the Times Benefiting the Church of the Latter-day Saints,” holograph, April 8, 1849, 177, Archives of the Family and Church History Department, Church of Jesus Christ of Latter-day Saints, Salt Lake City (hereafter cited as LDS Church Archives).

come the official Church record of the revolutions. He supplemented his history with a diary. Together the Appleby sources total two hundred handwritten pages.<sup>17</sup>

Wilford Woodruff (1807–98), apostle and Church president (1889–98), was a self-styled millennial abstractor. His diaries are filled with references to the revolutions. He firmly believed that 1848 reified the spirit of God. The “rapid succession” of universal turmoil consuming “the whole earth [was] rushing like a mighty cataract to finish its work,” he summarized. This new movement in history promised social justice and the triumph of the Saints. Therefore the Mormon people welcomed the uprisings as “the ownly [sic] ones who understand their fulfillment . . . and have cause to rejoice therein.”<sup>18</sup>

Apostle Orson Hyde managed an outfitting station on the Mormon Trail at Kanessville, Iowa, where he edited the *Frontier Guardian*, a trail journal that provided information for overlanders going to Utah.<sup>19</sup> Mormons knew Hyde for his 1841 trip dedicating Palestine for missionary work and the return of the Jews.<sup>20</sup> Hyde selected dispatches for his paper that reflected favorably on the progress of the revolutions, noting in the *Guardian*'s prospectus that the purpose of the paper was to promote “the spirit that is destined to bless the world” and to ensure that the “principles of our religion will always have a conspicuous place in our columns.”<sup>21</sup> Near the end of the European drama, Hyde printed an extract that linked the pioneers to the struggles of Europe. “In doubt, struggle, suffering un-

---

<sup>17</sup>William I. Appleby, *Autobiography and Journal, 1848–56*, holograph, LDS Church Archives.

<sup>18</sup>Scott G. Kenney, ed., December 8, 1848, *Wilford Woodruff's Journal: 1833–1898*, typescript, 9 vols. (Midvale, Utah: Signature Books, 1983–1985), 3:394–95; “Letter from Wilford Woodruff,” *Millennial Star* 11 (April 15, 1849): 117. Woodruff's most recent biographer is Thomas G. Alexander, *Things in Heaven and Earth: The Life and Times of Wilford Woodruff, a Mormon Prophet* (Salt Lake City: Signature Books, 1991).

<sup>19</sup>Jean Trumbo, “Orson Hyde's *Frontier Guardian*,” *Iowa Heritage Illustrated*, Summer 1996, 74–85; Myrtle Stevens Hyde, “Orson Hyde and the *Frontier Guardian*,” *Nauvoo Journal* 8, no. 2 (Fall 1996): 62–70.

<sup>20</sup>An account of Hyde's mission was published as *A Voice from Jerusalem, or a Sketch of the Travels and Ministry of Elder Orson Hyde* (Boston: Albert Morgan/Liverpool: Parley P. Pratt, 1842).

<sup>21</sup>Quoted in Hyde, “Orson Hyde and the *Frontier Guardian*,” 62.

speakable, dies the Old Order that the New may rise from its ashes," the *Frontier Guardian* reminded men and women trudging west. "Terrible . . . is the process, but let us believe that the result will be worth the pain."<sup>22</sup>

The British Mission, which in 1848 had jurisdiction over the whole European continent, saw two presidents between 1848 and 1849. Orson Spencer (1802–55) graduated from Union College and the Baptist Theological Seminary before converting to Mormonism in 1841. On January 23, 1847, he assumed leadership of the British Mission. After a failed attempt in 1852 to establish a mission in Prussia, Spencer was called to proselytize among the Cherokee Indians but died in St. Louis in 1855. His obituary stated that he had forsaken "an enviable position in society, and an extensive circle of influential acquaintances" to cleave to "down-trodden people."<sup>23</sup>

Orson Pratt (1811–81), one of the original Twelve, succeeded Spencer in August 1848 and remained in Great Britain until January 1851, during which time he wrote some of his most important doctrinal works. A quasi-scientist, Pratt sought to unite scientific knowledge with his perceptions of revealed truth.<sup>24</sup> On the revolutions of 1848, he averred, "The people, fighting centuries of bondage, were in arms against their sovereigns [in] a struggle indeed for Liberty and Human Rights."<sup>25</sup>

John Lyon, a Scottish poet and journalist who joined the Church in 1844, was well known to Mormons of his day. Devoted to demo-

<sup>22</sup>"The Tragedy of the Nations," *New York Tribune* reprinted in *Frontier Guardian*, June 13, 1849: [3]. The *Frontier Guardian* has neither volume nor page numbers.

<sup>23</sup>Jenson, *LDS Biographical Encyclopedia*, 1:337–39; Steven Epperson, *Mormons and Jews: Early Mormon Theologies of Israel* (Salt Lake City: Signature Books, 1985), 182 note 29.

<sup>24</sup>D. Michael Quinn, *The Mormon Hierarchy: Origins of Power* (Salt Lake City: Signature Books, 1994), 526; Breck England, *The Life and Thought of Orson Pratt* (Salt Lake City: University of Utah Press, 1984); David J. Whittaker, "Prolific Pamphleteer," *Dialogue: A Journal of Mormon Thought* 15 (Autumn 1982): 27–41; Erich Robert Paul, *Science, Religion, and Mormon Cosmology* (Urbana: University of Illinois Press, 1992), 128–41.

<sup>25</sup>Orson Pratt, "Building the Temple at Jerusalem," *Millennial Star* 11 (March 1, 1849): 68.

cratic ideals, he welcomed the 1832 reform bill as the “thunderous storm” that had “brought down” the “rogues” who allied with Presbyterian and Anglican prelates to keep “poor folks” subjugated.<sup>26</sup> Lyon wrote several poems inspired by the revolutions of 1848 and published them in *Harp of Zion* (1853). He wanted the collection to illustrate the congruity between world events and the “unique, all-encompassing gospel of the Mormon church,” a purpose which British Mission authorities endorsed.<sup>27</sup>

The bimonthly *Millennial Star* was printed at British Mission headquarters in Liverpool and, in 1848, was the voice of the Church. In fact, the *Frontier Guardian* and *Millennial Star* were the only Church publications between the 1845 demise of the *Times and Seasons* in Nauvoo and the first issue of the *Deseret News* in Salt Lake City in 1850. Unsigned articles in the *Millennial Star* in 1845 represented the opinion of the British Mission, which was under the direction of the Twelve.<sup>28</sup> With 17,000 subscriptions, the *Millennial Star's* circulation in 1849 exceeded that of the *Manchester Mercury*.<sup>29</sup>

Missionaries and Church members in the British Isles and the United States also registered their views in various sources. Harvey Locksley Birch, William M'Ghie, Elizabeth Cook (1816–89), and Thomas Dunlop Brown (1807–74) contributed to the *Millennial Star*. Little is known about them though three hymns are attributed

<sup>26</sup>John Lyon, “Song of Reform” (1833), in *Songs of a Pioneer* (1923), cited in T. Edgar Lyon, *John Lyon: The Life of a Pioneer Poet*, Vol. 6 in the Religious Studies Center Specialized Monograph Series (Provo, Utah: Religious Studies Center, Brigham Young University, 1989), 348.

<sup>27</sup>See T. Edgar Lyon, *John Lyon*, 92–93, 156–62, for a discussion of John Lyon's political and journalistic activity and the background of *Harp of Zion*.

<sup>28</sup>James B. Allen, Ronald K. Esplin, and David J. Whittaker, *Men with a Mission, 1837–1841: The Quorum of the Twelve in England* (Salt Lake City: Deseret Book, 1992), 252–55; Ronald W. Walker, David J. Whittaker, and James B. Allen, *Mormon History* (Urbana: University of Illinois Press, 2001), 208.

<sup>29</sup>“Samples of Mormon Blasphemy and Impudence,” *Millennial Star* 11 (February 1, 1849): 45; Hubert Howe Bancroft, *History of Utah, 1540–1886* (San Francisco: The History Company, 1889), Appendix 19.

to Birch.<sup>30</sup> George Simms, George Lunt, and J. C. Lord, the latter possibly being a tongue-in-cheek pseudonym for “Jesus Christ Lord,” contributed to the *Frontier Guardian*.<sup>31</sup> Simms later drowned in the Platte River.<sup>32</sup> James Henry Flanigan (1822–52) was a missionary and diarist who was eulogized as “an exception among men.”<sup>33</sup> Curtis Edwin Bolton (1812–90) converted to Mormonism in 1842 and fought in the Battle of Nauvoo. He opened the French Mission in 1850 and translated the Book of Mormon. In 1851 he recorded in his diary observations about how Napoleon III extinguished the revolutionary spirit.<sup>34</sup>

### EXCITEMENT FOR REPUBLICAN GOVERNMENT

The Mormon observers assumed that republican forms of

---

<sup>30</sup>Birch’s hymns are “Millennial Morning,” “The Mountain Standard,” and “The Rising Glory of Zion.” A Thomas Dunlop Brown appears in the International Genealogical Index, retrieved on May 3, 2004, from [www.familysearch.org](http://www.familysearch.org). Several women named Elizabeth Cook are also listed in the International Genealogical Index, but the one identified here is probably the one listed in Journal History of the Church of Jesus Christ of Latter-day Saints (chronological scrapbook of typed entries and newspaper clippings, 1830–present), June 13, 1889, 6, LDS Church Archives, and Early Church Membership File, 1028, LDS Church Archives. She was born in Manchester, England and died a “faithful Latter-day Saint.”

<sup>31</sup>I cannot ascertain whether this George Lunt is the editor of the *Boston Globe* or a little-known Mormon. Hyde normally attributed his source unless a piece was directly submitted to the *Guardian*. Lunt’s pieces give his name only, with no reprint information.

<sup>32</sup>Two men named James and John Lord lived in the Nauvoo area but neither had a middle name beginning with “C.” Melvin Bashore, LDS Church Library, Letter to Craig Livingston, May 21, 2003. For Simms see Missionary Index, Church History Library, Salt Lake City.

<sup>33</sup>Davis Bitton, *Guide to Mormon Diaries and Autobiographies* (Provo, Utah: Brigham Young University Press, 1977), 12, 109; Lyman Omer Littlefield, *Reminiscences of Latter-day Saints*, 40–41; on *New Mormon Studies: A Comprehensive Resources Library*, CD-ROM (Salt Lake City: Smith Research Associates, 1998).

<sup>34</sup>Curtis Edwin Bolton, “Reminiscences and Journal,” LDS Church Archives; Bitton, *Guide to Mormon Diaries*, 253; Cleo H. Evans, comp., *Curtis Edwin Bolton: Pioneer, Missionary: History, Descendants, and Ancestors* (Fairfax, Va.: Cleo H. Evans, 1968).

government would necessarily precede large-scale global transformations. The *Millennial Star* speculated that the revolutions would purge the old order and prepare the way for man and God to rework the political world. In 1848 the European Party of Movement (intellectuals, students, workers, and artisans) and its nemesis, the Party of Order (feudal lords and large capitalists) were colliding, and the *Millennial Star* left little doubt where the Church stood: In the “sudden and unlooked for interchange of institutions,” governments of “mere human origins must be broken and ploughed as a field.”<sup>35</sup> Nationalists in north Germany and the Hapsburg domains of central Europe and north Italy preferred constitutional monarchy. True Republicans—mostly intellectuals, students, veteran radicals, and labor leaders—were a minority in Europe but were found almost everywhere. Their most spectacular success during the revolutions of 1848 were in Rome and France, in consequence drawing the attention of the Mormon observers.

Republicanism in 1848 was a legacy of the original French Revolution of 1789–93. Democrats and socialists, the radical shade of republicanism, believed that these years had augured humankind’s liberation from the *ancien régime* but that reactionary forces had cut short this process. Republicans, like liberals, stood for parliamentary government but were more entranced by revolutionary process and the achievement of equality. They hated established churches, believing that clerics opposed the triumph of liberty and reason.<sup>36</sup>

Appleby and Woodruff were unruffled by the violence. Whether looking “towards *Babylon* or *Zion*,” Woodruff believed he was witnessing God’s work. For him, 500 deaths were a small price to pay for the establishment of a French republic.<sup>37</sup> Appleby approved the roughness with which Parisians seized the throne and burned

---

<sup>35</sup>Thomas D. Brown, “A Letter of Warning,” December 16, 1848, *Millennial Star* 11 (February 1, 1849): 34. The terms “party of Order” and “party of Movement” are borrowed from Sperber but Marx also referred to them this way. See Marx, “The Class Struggles in France” [1850], in *Karl Marx: Selected Writings*, edited by David McLellan (New York: Oxford University Press, 1977), 294.

<sup>36</sup>Robert R. Palmer and Joel Colton, *A History of the Modern World*, 7th ed. (New York: Alfred A. Knopf, 1991), 466–67.

<sup>37</sup>*Wilford Woodruff’s Journal*, December 28, 1848, 3:394–95; Wilford

it.<sup>38</sup> The “hurricane of 1848,” Appleby wrote, wiped out the Bourbon and Orleanist aberrations and institutionalized the “liberal ideas” of 1789.<sup>39</sup>

Appleby shared his republicanism with Mazzini, the Italian nationalist who envisioned a “Young Europe” federation of nations joined by the spiritual authority of the people: “Kings and nobles cannot maintain their positions, and before another year passes, we shall probably see no thrones among the Teutonic, perhaps none among the Latin races. The example of France must soon be followed in Germany and Italy and ultimately in Scandinavia and the Peninsula. England, Spain, Austria, Russia, Prussia, Germany . . . with the Slavic tribes, Hungarians . . . will [break] the fetters of despotism and aristocracy and kingly power.”<sup>40</sup> Revolution, explained Appleby, would produce international harmony throughout Europe. In New York, Appleby admired German-Americans who were loading arms on ships bound for German ports and who had volunteered to defend republicanism and the Frankfurt Assembly.<sup>41</sup>

The observers were convinced that France was the bellwether of the revolution. Woodruff and Appleby associated France with the spread of republicanism.<sup>42</sup> When Russia assured Austria in May 1849 that it would invade Hungary, Hyde identified the “Red” (democrat-so-

Woodruff, Letter, March 1, 1848, *Millennial Star* 11 (April 15, 1849): 117. The actual number killed in the February revolution was twenty. Palmer and Colton, *A History of the Modern World*, 502.

<sup>38</sup>Appleby, *Autobiography and Journal*, April 1848, 228–29; Appleby, “History of the Signs of the Times,” June 1848, 8.

<sup>39</sup>Appleby, *Autobiography and Journal*, April 1848, 229.

<sup>40</sup>Appleby, “History of the Signs of the Times,” October 20, 1848, 160–61. On the Mazzinian international, see Billington, *Fire in the Minds of Men*, 149–52, 162; Noether, “Mazzini and the Nineteenth Century Revolutionary Movement,” in *Consortium on Revolutionary Europe, 1750–1850: Proceedings* 14 (1984): 277–85.

<sup>41</sup>Appleby, *Autobiography and Journal*, April 1848, 227. See also Roberts and Howe, “The United States and the Revolutions of 1848,” 166–67.

<sup>42</sup>*Wilford Woodruff's Journal*, April 23, 1848, 3:345; Wilford Woodruff, Letter to Orson Spencer, April 24, 1848, *Millennial Star* 10 (June 15, 1848): 186; Appleby, “History of the Signs of the Times,” September 18, 1848, 152–53.

cialist) Republicans in the French Assembly as the only constituency still proclaiming Hungarian nationalism and the republics of Poland, Rome, Naples and north Italy. Only with French radicals in the lead could the European Party of Movement check the Russian threat.<sup>43</sup>

Orson Spencer in the *Millennial Star* praised the establishment of a French republic but added a word of caution: A “critical period in the political affairs of the French nation” existed, for European monarchs would attempt to neutralize French influence as they had during the revolutionary and Napoleonic wars of 1792–1815.<sup>44</sup> His analysis was astute. The suppression of the French left and Napoleon III’s restoration of Pius IX to Rome dashed hopes for republicanism throughout Europe. Orson Hyde, however, believed that French universalism was only temporarily submerged. The scheme to restore the Pope in Rome was “extremely distasteful to the French troops,” he noted, and predicted that the sell-out of republicanism would boomerang on the conservative government.<sup>45</sup>

The progress of the revolutions in the Austrian Empire and Italy attracted nearly as much attention as events in France. The ministers of the 1815 Congress of Vienna were swept away, Appleby wrote. Sovereigns across Europe had submitted to popular demands and “the people drove Prince Metternich from his lofty eminences.”<sup>46</sup> Stubborn defenses of republican strongholds inspired alternately gritty and romantic images of the fighting. When Austrian Generals Josip Jelačić and Prince Alfred Windischgrätz shelled Vienna and overwhelmed the barricades in November 1848, Appleby memorialized the democratic resisters as “men fighting for freedom and rights and endeavoring to break the chains of despotism and oppression.”<sup>47</sup> The *Frontier Guardian* featured several heroic mosaics. Around Palermo, Sicily, women of all classes were digging trenches to counter King Ferdinand’s siege lines; inside Ingölstadt, Bavaria,

---

<sup>43</sup>Hyde, “Foreign News,” *Frontier Guardian*, May 16, 1849, [3]; and June 27, 1849, [3]. For Russia’s reactionary potential, see Palmer and Colton, *History of the Modern World*, 506.

<sup>44</sup>“April 1, 1848,” *Millennial Star* 10 (April 1, 1848): 103–4. No author is identified but it reads like Spencer.

<sup>45</sup>“Foreign News,” *Frontier Guardian*, July 11, 1849, [3].

<sup>46</sup>Appleby, *Autobiography and Journal*, March 1848, 221, and April 1848, 229.

<sup>47</sup>*Ibid.*, November 20, 1848, 167.



the defenders were fighting to the death under the black flag.<sup>48</sup>

The Mormon observers tolerated Pius IX as long as the pope seemed sympathetic to republican government. But when the citizens of Rome proclaimed a republic, Appleby declared the old Papal States “a nullity.”<sup>49</sup> Woodruff excused Garibaldi and Mazzini for the “bestly power” of violence used to create the Roman republic. News of the “Pope of Rome laid prostrate & he driven from his Kingdom” led Woodruff to predict that even the Romanovs would not likely survive the spreading fever of revolt.<sup>50</sup> John Lyon gloated over “Pope-less (!) ’Forty-nine” with a zeal equal to his demand for British popular enfranchisement and the humbling of clerical hubris.<sup>51</sup> Pius was reinstated in 1849, but the *Millennial Star* optimistically assessed the future: “The papal throne is shaken, and the Holy See disgraced. These great and important movements are destined to prepare the way for the kingdom of Heaven to be established on earth.”<sup>52</sup>

Hungary’s fight received special attention from the observers due to the popularity of Louis Kossuth. Hyde published extracts of Kossuth’s speech informing the world that “the women shall dig a deep grave,” in which they would “bury the name, the honor, the nation of Hungary or our enemies.”<sup>53</sup> George Lunt deified Kossuth as the eastern incarnation of France:

---

<sup>48</sup>“Foreign News,” *Frontier Guardian*, June 27, 1849, [3]; and “Foreign News,” *ibid.*, August 22, 1849, [3]. The black flag had dual meaning in 1848. It was the original banner of proletarian revolution dating back to 1830, and it also symbolized mourning for people fighting a losing struggle for nationhood. Billington, *Fire in the Minds of Men*, 151, 159, 281.

<sup>49</sup>Appleby, “History of the Signs of the Times,” November 29, 1848, 169.

<sup>50</sup>*Wilford Woodruff’s Journal*, December 31, 1848, 3:395; January 9, 1849, 3:404.

<sup>51</sup>John Lyon, “Address to ’Forty-Nine,” in *Harp of Zion* (Liverpool: S. W. Richards, 1853), 91.

<sup>52</sup>“The Destroyer Already Rideth Upon the Face of the Waters,” *Millennial Star* 11 (August 15, 1849): 253. Reprinted from the *Frontier Guardian*.

<sup>53</sup>“Kossuth,” reprinted from the *Boston Transcript* in *Frontier Guardian*, August 8, 1849, [3]. See also *Wilford Woodruff’s Journal*, September 23, 1849, 3:483.

[He] Has shot a newer gleam.  
 The paling despot sees it shine,  
 The serf beholds the beam. . . .

Once more the voice of Ages rolls  
 Kossuth! and calls for thee!<sup>54</sup>

The Mormon observers were aware of Russia's potential for reaction. "The Great Bear of the North," Appleby wrote, "is as yet an unexcited spectator of these magical transformations. Yet even Russia will have to engage in the general strife when the voice of oppressed and unappeased Poland rises high." In the Russian invasion of Poland and Hungary, Appleby believed he was witnessing the timeless encounter "between the spirit of human freedom and despotism."<sup>55</sup> Harvey Birch faced reality: Russo-Austrian behavior was consistent with their "professed principles" of anti-republicanism. With gruesome enthusiasm, Woodruff hoped for the fulfillment of Zechariah 14:12, that the lice infestation afflicting the Russian army would make the soldiers' flesh fall from their bones and their eyes from their sockets.<sup>56</sup>

#### GODLY REPUBLICANISM AND JEWISH EMANCIPATION

Mormon expectations received an added impetus from prophecies related to the establishment of a Jewish state. Mormon doctrine taught that Ephraim, one of the Lost Tribes of Israel, would be gathered out of the world and exercise leadership over the millennial order.<sup>57</sup> Emancipation from restrictive laws, Mormons observers held, would prepare a Jewish political cadre for its historic role.

Jewish emancipation had become a social, political, and eco-

<sup>54</sup>George Lunt, "Kossuth," *Frontier Guardian*, March 6, 1850, [4].

<sup>55</sup>Appleby, *Autobiography and Journal*, April 1848, 330; Appleby, "History of the Signs of the Times," March 24, 1849, 177.

<sup>56</sup>Appleby, "History of the Signs of the Times," March 24, 1849, 177; Harvey Locksley Birch, Letter to Orson Pratt, August 16, 1849, *Millennial Star* 11 (October 1, 1849): 298; *Wilford Woodruff's Journal*, August 25, 1849, 3:478.

<sup>57</sup>Mormon concepts of racial elitism versus universalism are discussed in Armand Mauss, *All Abraham's Children: Changing Mormon Conceptions of Race and Lineage* (Urbana: University of Illinois Press, 2003); Arnold

conomic issue in Europe by 1848. Jews in France and the Netherlands enjoyed full citizenship status, but discriminatory laws in the German Confederation and the Austro-Hungarian Empire made them a segregated, disenfranchised minority. Liberal and Jewish delegates to the German and Austrian assemblies wanted to incorporate Europe's Jews. Their two-fold arguments rested first on the liberal theory that equality was vital to economic prosperity and, second, that recognition of human rights required freedom from medieval prejudice.<sup>58</sup> Gabriel Riesser, the Jewish vice-president of the Frankfurt National Assembly, linked emancipation to unification: "The messiah . . . has appeared and our fatherland has been given to us. The messiah is freedom, our fatherland is Germany."<sup>59</sup>

Appleby marveled over the rights granted to Jews in the newly established Roman Republic.<sup>60</sup> For Wilford Woodruff, ending the Diaspora through revolution would uplift humankind. Jewish civil and landholding rights and seats in Parliament signaled necessary tutelage that would prepare them for their future role as co-administrators of the kingdom of God.<sup>61</sup> Orson Pratt praised the "great men" among the Jews, especially in France and Germany, who had been "busy amid these revolutions. It was not to be that a people of their literary, political, and commercial influence—the bankers of Europe, the merchants of England, the statesmen of France, the philosophers of Germany, the agriculturists of Poland, the poets of Italy, the artists, the mechanics, the soldiers everywhere, could see these mighty events developing themselves on the Continent without participating actively in the progress and results."<sup>62</sup> The rise of Jews to "highest stations in governments" would lead to their restoration in Palestine. From there, "those laws which Moses had consecrated to liberty and

H. Green, "Gathering and Election: Israelite Descent and Universalism in Mormon Discourse," *Journal of Mormon History* 25 (Spring 1999): 195–228.

<sup>58</sup>Simon Dubnow, *History of the Jews: From the Congress of Vienna to the Emergence of Hitler*, Vol. 5 (South Brunswick, N.J.: Yoselof, 1973), 255–314.

<sup>59</sup>Glenn R. Sharfman, "Jewish Emancipation of 1848," in *Encyclopedia of 1848 Revolutions*, edited by James Chastain, retrieved on June 14, 1999, from <http://cscwww.cats.ohiou.edu/~Chastain/ip/junedays.htm>.

<sup>60</sup>Appleby, *Autobiography and Journal*, December 2, 1848, 247.

<sup>61</sup>*Wilford Woodruff's Journal*, December 12, 1849, 3:517.

<sup>62</sup>Orson Pratt, "Building the Temple at Jerusalem," *Millennial Star* 11 (April 1, 1849): 83–84.

republican forms of government” would be reinstated throughout the world.<sup>63</sup>

Pratt’s pairing of “Moses” and “republican” had a counterpart among arcane romantic nationalists who also mixed Talmudic imagery with nineteenth-century ideas.<sup>64</sup> In the version envisioned by Mormon observers, two hemispheric kingdoms—one with a capital in Jerusalem and the other in Missouri—represented polarities destined to unite humanity. The return of Ephraim would conjure into reality global brotherhood, the Jewish nation would gain global eminence, and revolution would eventually produce a sort of theocratic republicanism.<sup>65</sup>

### REVOLUTION PROMOTES MISSIONARY WORK

The Mormon millenarian tradition stipulated that, before the Second Advent, the world must receive the chance to hear the gospel and gather to Zion. The observers conjectured that social and political upheaval would expedite the process: “Great convulsive shocks must take place before the gospel can be tolerated universally,” stated an editorial in the *Millennial Star* as the first reports of continental disturbances arrived in England.<sup>66</sup> The *Millennial Star* editorialized again on missionary prospects after the red flag appeared in Paris. “The Latter-day Saints feel the effects of poverty, but these commotions must precede the introduction of the gospel to many nations.

---

<sup>63</sup>Ibid., 68. The failure of the revolutions to obtain total Jewish emancipation affected Pratt’s later teachings. In 1871 he speculated that Israel would not be restored to Jerusalem until missionaries had visited all gentiles and that they would convert to membership in the Mormon kingdom of God. Epperson, *Mormons and Jews*, 181, 193.

<sup>64</sup>Billington, *Fire in the Minds of Men*, 325.

<sup>65</sup>Compare *ibid.*, 218–20 to other iterations of Mormon one-worldism in which revolution and the Jewish restoration to Palestine figure: Orson Pratt in Gary James Bergera, “‘Let Br. Pratt Do As He Will’: Orson Pratt’s 29 January 1860 Confessional Discourse—Unrevised,” *Dialogue: A Journal of Mormon Thought* 13 (Summer 1980): 51; Italian mission president Jabez Woodard to Willard Richards, September 18, 1852, in Eliza R. Snow, comp., *Biography and Family Record of Lorenzo Snow* (Salt Lake City: Deseret News, 1884), 229.

<sup>66</sup>Editorial, *Millennial Star* 10 (April 1, 1848): 104; 10 (June 15, 1848): 185; *Wilford Woodruff’s Journal*, February 15, 1849, 3:419.

Therefore we will rejoice in those things which make many sorry. . . . The stumbling blocks of despotism, and bigotry, and aristocratic monopoly, that so frequently deter the poor from obeying the gospel, will be moved out of the way, and a highway cast up for the ransomed to walk in."<sup>67</sup>

At the LDS conference in October 1848 at Manchester, England, local leaders announced that the revolutions in Europe had created conditions favorable to preaching not seen during the "past seventeen hundred years." The audience heard positive sermons from the elders: "Let the poor in the isles rejoice [for] the day of their deliverance is at hand."<sup>68</sup>

In spring 1848, English Mormons, most of them working-class converts, anticipated relief from unemployment or low wages and Anglican harassment.<sup>69</sup> Expectations ran high that the disabling of repressive regimes elsewhere would be permanent and that the weakening of high church influence in Britain would trigger an explosion of conversions. Appleby published a broadside in Philadelphia endorsing armed struggle as the surest method of emancipating the mind. Only when "kings and nobles stand afraid with terror and dismay," he wrote, could the gospel reach "every kindred and tongue."<sup>70</sup> The revolutions were working their historic role as "recent accounts show that

<sup>67</sup>"April 15, 1848" (editorial), *Millennial Star* 10 (April 15, 1848): 119–20. Orson Spencer probably wrote this editorial.

<sup>68</sup>"Conference Minutes," *Millennial Star* 10 (September 1, 1848): 263. Similar sentiments are found in "The Gospel Witness," *Millennial Star* 10 (June 1, 1848): 165; 11 (April 15, 1849): 118.

<sup>69</sup>For the social and religious background of early Mormon converts in Great Britain see Allen, Esplin, and Whittaker, *Men with a Mission*, 323–40; Rebecca Bartholomew, *Audacious Women. Early British Mormon Immigrants* (Salt Lake City: Signature Books, 1995), 32–36; Susan L. Fales, "Artisans, Millhands, and Laborers: The Mormons of Leeds and Their Non-conformist Neighbors," in *Mormons in Early Victorian Britain*, edited by Richard L. Jensen and Malcolm R. Thorp (Salt Lake City: University of Utah Press, 1989), 164; Polly Aird, "Why Did the Scots Convert?" *Journal of Mormon History* 26 (Spring 2000): 94; P. A. M. Taylor, "Why Did Mormons Emigrate," *Utah Historical Quarterly* 22 (July 1954): 260.

<sup>70</sup>William I. Appleby, *Lines Suggested and Composed on the Present State of the World* (Philadelphia: Bicking and Guilbert, 1 May 1848), broadside, LDS Church Archives.

republican doctrines are daily spreading among the people; and that the battle for life between democracy and aristocracy has already begun and will soon be decided. Aristocracy must die. . . . Republicanism will go before and prepare the way for toleration."<sup>71</sup>

The *Star's* glee over republican victories would not have endeared the mission office to the British government. Fear of a republican- or nationalist-inspired revolt fermented in England. In April 1848 the British government, wary of the Chartist left wing, enrolled thousands of temporary constables and sent fresh troops to Ireland to ferret out Young Ireland insurrectionists.<sup>72</sup> The nearer revolutionary agitation seemed to approach Great Britain, the more intensely did the mission office encourage British Saints to sail to America: The "revolution in France, and the bloody scenes in the south of Europe, have recently been followed with numerous alarming disturbances in England, Scotland, and Ireland. . . . These things should warn the Saints to secure a safe hiding-place in the kingdom of God and land of Zion."<sup>73</sup>

Orson Spencer, the mission president, suggested that the "abstracting" of good people from their countries would hasten the collapse of old political authority, thus contributing to the revolutionary cause.<sup>74</sup> Spencer exploited class antagonism to loosen the loyalty of British converts to their country. In the *Millennial Star*, he printed extracts from *The Black Book of British Aristocracy* (1848), a treatise that denounced ruling-class privileges. Revolutionary conditions existed,

---

<sup>71</sup>Appleby, "History of the Signs of the Times," October 20, 1848, 160-61.

<sup>72</sup>Billington, *Fire in the Minds of Men*, 181-82. Contemporary rumors of French agents in Ireland are discussed in Leslie Mitchell, "Britain's Reaction to the Revolutions," in *The Revolutions in Europe*, 94. The Church press reported the arming of the peasantry and British troop build-ups in "Ireland," *Millennial Star* 9 (January 1, 1847): 1, 3-4.

<sup>73</sup>"April 1, 1848," *Millennial Star* 10 (April 1, 1848): 103.

<sup>74</sup>See *Millennial Star* articles: "The Black Book of British Aristocracy," 10 (May 15, 1848): 145; "The Gospel Witness," 10 (June 15, 1848): 179; "The Day of God's Power," 10 (August 1, 1848): 227. The British mission log records an upper class "uproar" in response to suspected missionary agitation among workers. Joseph Westwood, Hull, England, June 12, 1848, British Mission: Historical Records and Minutes, reel 9, October 15, 1848, 1, LDS Church Archives.

concluded Spencer. British workers were taxed twice as much as their French counterparts to support upper-class frivolities.<sup>75</sup> Spencer borrowed from the French revolutionary trinity (liberty, equality, and fraternity) to communicate the benefits of migration. In Utah, converts would be “organized on the principles of godliness, fraternity, and liberty.”<sup>76</sup> Spencer’s use of “godliness” in place of “equality” is a linguistic swap referred to as metonymy, or the substituting of one word for another that is closely related to it. Discourse analysts suggest that such metaphoric switches evoke particularly intense meaning.<sup>77</sup> By associating *equality* with “godliness,” Spencer thus identified the fraternity of Zion with the erasure of poverty, property exploitation, and class privilege. Thus, Spencer invested the Mormon gathering to Utah with imprints of the 1848 revolutions.

Rank-and-file missionaries joined the chorus of their leaders. Robert Flanders in *Nauvoo: Kingdom on the Mississippi* notes that missionaries during the 1840s spoke of a “new heaven and a new earth . . . of Christian revolutionaries, of brotherhood and equality, and of emigration to the Kingdom of God.”<sup>78</sup> A British mission report in August 1848 hinted that the upheavals had humbled heads of state, making them receptive to the “perfect system of government” that would accompany “the second coming of our Lord.”<sup>79</sup> Thomas Dunlop Brown recorded that the “ploughed nations” would open their doors to mis-

<sup>75</sup>“The Black Book of British Aristocracy,” 146. The extracts came from *The Black Book of the British Aristocracy; or, An Exposure of the More Monstrous Abuses in the State and the Church, with Black Lists of Pensioners, Royal, Aristocratic, Legal, etc.* (London: William Strange, 1848).

<sup>76</sup>“The Black Book of British Aristocracy,” 145.

<sup>77</sup>Geoffrey N. Leech, *A Linguistic Guide to English Poetry* (New York: Longman, 1991), 74, 152.

<sup>78</sup>Flanders, *Nauvoo: Kingdom on the Mississippi*, 62. See also W. H. Oliver, *Prophets and Millennialists: The Use of Biblical Prophecy in England from the 1790's to the 1940's* (Auckland, New Zealand: Auckland University Press, 1978), 230, 238; Hyrum Andrus, “The Second American Revolution: Era of Preparation,” *BYU Studies* 2 (Winter 1960): 91; Marvin S. Hill, “The Shaping of the Mormon Mind in New England and New York,” *BYU Studies* 9 (Spring 1969): 358–70.

<sup>79</sup>British Mission: Historical Records and Minutes, reel 8, [internally dated] August 13, 1848.

sionaries who come with a “gospel of peace and salvation.”<sup>80</sup> The ebullient Birch added, “These [revolutions] are fast preparing the nations to receive the message from heaven, removing all obstacles to the spread of truth, by the bursting asunder the chains of tyranny—opening the political and moral prison door . . . and displacing the high minded, proud, and intolerant.”<sup>81</sup> James Henry Flanigan attributed growing protest against “popery” in the Anglican Church to the people’s newfound courage to withstand authority.<sup>82</sup>

Converts responded. The membership rolls of the British Mission rose more steeply between 1847 and 1851 than in any other four-year period of the nineteenth century.<sup>83</sup> By 1851 the British membership totaled 33,000, the highest during the century. From 1848 to 1850, 4,229 Mormon passengers sailed to New Orleans.<sup>84</sup> “Thousands of England’s sons and daughters, who now groan in poverty and distress,” the mission log records, were being “wafted by the gentle breezes of heaven to a land of deliverance and plenty.”<sup>85</sup>

Virtually no news could tarnish Mormon hopes even when reac-

---

<sup>80</sup>Thomas Dunlop Brown, “A Letter of Warning,” *Millennial Star* 11 (February 1, 1849): 37.

<sup>81</sup>Harvey Locksley Birch, Letter to Orson Pratt, August 16, 1849, *Millennial Star* 11 (October 1, 1849): 298.

<sup>82</sup>James Henry Flanigan, Diary, November 11, 1850, 112, LDS Church Archives. Since the 1820s the Anglican Church had come under increasing attack. Grant Underwood, “The Religious Milieu of English Mormonism” in *Mormons in Early Victorian Britain*, 33. In 1848 an Anglican bishop lost his libel suit in a publicized court case. Postgate, *The Story of a Year: 1848*, 101–6.

<sup>83</sup>Richard L. Jensen, “The British Gathering to Zion,” in *Mormons in Early Victorian Britain*, 173.

<sup>84</sup>P. A. M. Taylor, *Expectations Westward: Mormons and the Emigration of the British Converts in the Nineteenth Century* (London: Oliver and Boyd, 1965), 20; Richard E. Bennett, “We’ll Find the Place”: *The Mormon Exodus, 1846–1848* (Salt Lake City: Deseret Book, 1997), 311–13; *Deseret News 1997–1998 Church Almanac* (Salt Lake City: Deseret News, 1996), 159–60.

<sup>85</sup>British Mission: Historical Records and Minutes, reel 9, October 15, 1848, 2. Historians have suggested that several Mormon converts were Methodists disappointed by the failed Chartist movements of 1837, 1842, and 1848. Flanders, *Nauvoo: Kingdom on the Mississippi*, 62–63; Harrison, “The Popular History of Early Victorian Britain: A Mormon Contribution,”



tionary forces began regrouping for a counter-stroke. Writing in March 1849 Orson Pratt anticipated that the “blow” delivered to the “powerful union of Church and State” promised freedom: “The Allied sovereigns may succeed in overpowering the people and maintaining their thrones and scepters, but great concessions will be made to the wishes of the people to avoid a hurricane of frightful outbreaks. The people are no longer in chains.”<sup>86</sup>

### THE SCRIPT OF SOCIAL REVOLUTION

While the first sight of social revolution frightened most Americans, it emboldened the Mormon observers. It was on the point of class conflict that Mormons observers deviated most sharply from American public opinion. They condoned violence in pursuit of social amelioration just as they had affirmed its necessity to achieve national fraternity or parliamentary institutions. The uprisings and foundational “tremblings” of the people, as Woodruff called them, weighed especially on France where the “social questions are all pregnant with vast Results.”<sup>87</sup>

God, Appleby assumed, was orchestrating the social revolution in Europe. “When I . . . see the oppression of the poor and man taking the advantage of his fellow man,” he wrote in his journal, “I exclaim surely the Lord is at work among the nations and Kingdoms of the Earth to bring about his righteous purpose.”<sup>88</sup> His Philadelphia broadside decried laws construed to favor the rich and chastised rul-

8, 12–13; *Second Coming*, 189–90; Malcolm Thorp, “Popular Mormon Millennialism in Nineteenth-Century Britain,” *Journal of Mormon History* 31 (Summer 2005): 110–11, emphasizes that the excitement of the restoration and “identity reinforcement” best explains the desire to migrate to Utah. Allen, Esplin, and Whittaker, *Men with a Mission*, 325, argue that ideological disillusionment was less decisive than sheer economic hardship.

<sup>86</sup>Orson Pratt, “Building the Temple at Jerusalem,” *Millennial Star* 11 (March 1, 1849): 68. Austria was believed to have grown more tolerant, and Woodruff predicted that France would soon supply “efficient preachers” to the Mormon cause. *Wilford Woodruff’s Journal*, January 9, 1849, 3:404; December 28, 1848, 3:395–96; February 11, 1849, 3:417; “A Religious Money Mission to France,” *Millennial Star* 10 (July 15, 1848): 211.

<sup>87</sup>*Wilford Woodruff’s Journal*, April 29, 1848, 3:345; “Signs of the times and remarks upon the year AD 1849,” December 1849, 3:517.

<sup>88</sup>Appleby, *Autobiography and Journal*, February 4, 1848, 217.

ers and capitalists who robbed the lower classes.<sup>89</sup> Amid his commentary on the bombardment of Vienna, rioting in Prague, and the Polish uprising is Appleby's desire for a social revolution. He admitted in June 1848 that his views were almost "eutopian" and virtually indistinguishable from those of secular communitarians and barricade-building radicals.<sup>90</sup>

The class conflict that stimulated Appleby also penetrated the imagination of several British missionaries. Birch believed that the "dismemberment of empires, the clashing of social institutions, the overthrow of feudal governmental systems [and] the outbreaks of . . . democratic violence" would raze the "rotten foundations of men's faith" and indifference.<sup>91</sup> Brown hoped for a comprehensive leveling of society that would rectify everything that had gone wrong in history. Revolutions were destroying the clay-and-iron feet of the statue in Daniel's dream. Dethroned kings, violent displacement of the ruling class, and murder of the "capitalists" were prerequisite to the millennium.<sup>92</sup>

At mission headquarters in Liverpool, Orson Spencer, a supporter of the Chartist petition, championed the "labouring classes" as "indispensable to the prosperity and very existence of any nation." In a general epistle Spencer assailed the socioeconomic order: "The nations had endured their erroneous creeds so long, that they have fairly and fully proved them palpably false and insupportably prejudicial to the happiness and peace of the human family. They are beginning to make a violent effort to burst asunder their shackles, and resuscitate long extinguished rights. The effort of the industrial classes to overthrow the sway of iron despotism, seems to be almost simultaneous throughout every nation in Europe."<sup>93</sup> Spencer attributed the formation of a proletarian army to a spiritual transformation:

<sup>89</sup>Appleby, *Lines Suggested and Composed on the Present State of the World*.

<sup>90</sup>Appleby, "History of the Signs of the Times," June 1848, 7.

<sup>91</sup>Harvey L. Birch, Letter to Orson Pratt, *Millennial Star* 11 (October 1, 1849): 297.

<sup>92</sup>Thomas Dunlop Brown, "A Letter of Warning," *Millennial Star* 11 (February 1, 1849): 37-38.

<sup>93</sup>Orson Spencer, "April 15, 1848," *Millennial Star* 10 (April 15, 1848): 119.

The whole political aspect of numerous and powerful governments changed as it were in a day! A large and warlike army of 80,000 soldiers in the capital of France . . . suddenly converted from their allegiance to the sovereign to . . . the people, and [took] sides with the oppressed against the oppressor! This spirit of sympathy for the laboring people, spreading among so many nations with electric speed, is surely ominous that the hand of the Mighty God of Jacob is at work in turning and over-turning, until He . . . shall come and reign on the earth.<sup>94</sup>

Orson Hyde printed extracts from a radical journal, Karl Marx's *New Rhenish Gazette*.<sup>95</sup> Both the *Gazette* and *Frontier Guardian* favored news, commentary, and gritty portrayals of the human spirit in action. Also, the editors of both liked radical poets.<sup>96</sup> For example, Hyde's reiteration of students and "proletaires" resisting Hapsburg forces from behind the Vienna barricades sculpts a frieze of revolutionary heroism.<sup>97</sup> J. C. Lord, whom Hyde frequently printed, employed literary tropes to describe the thrill of revolution: "To exile goes the king, the throne is in the street; / And royal floors are echoing the sound of Plebian feet."<sup>98</sup>

Faith in worker activism, however, proved premature. The workers' uprising in Paris June 23–26, 1848, made clear the limits of social revolution to the Mormon observers. The insurrection resulted from the decision to discontinue the public works programs established by the Second Republic. Barricades went up all over the city, and proclamations demanded a social and democratic republic, state-sponsored labor associations, and the impeachment or arrest of conservatives in the National Assembly and Luxembourg Commission. The French government responded savagely. General Eugene Cavaignac crushed the uprising; about 1,500 were killed on each side. As many as 3,000 Parisians were executed in the after-

<sup>94</sup>Ibid., 120. The "80,000 soldiers" were the National Guard.

<sup>95</sup>Orson Hyde, "Foreign News," *Frontier Guardian*, June 17, 1849, [3]. Prussian authorities suppressed Marx's paper May 19, 1849.

<sup>96</sup>Marx tolerated no one who failed to appreciate his views, but he showed uncharacteristic patience toward radical poet Heinrich Heine. See Francis Wheen, *Karl Marx: A Life* (New York: W. W. Norton, 2000), 64–65.

<sup>97</sup>Orson Hyde, "Foreign News," *Frontier Guardian*, June 27, 1849, [3].

<sup>98</sup>J. C. Lord, "Kings and Thrones Are Falling," *Frontier Guardian*, January 9, 1850, [4].

math, and another 4,500 were deported.<sup>99</sup>

Mormon observers and contemporary leftists believed stories that the Paris workers' revolt had been instigated by conservative agents working to discredit the democrats.<sup>100</sup> Appleby blamed both sides for the disaster. The government had mishandled the situation, and Parisian workers had made economic demands that pushed France to the "verge of anarchy." God had sanctioned the trajectory of French politics until June 1848, but Appleby believed that the abortive workers' revolt was a reminder that the divine task of the revolutionist demanded purity of motivation, discipline, and good timing.<sup>101</sup>

Sympathy for French workers was widespread among Mormon observers despite unflattering commentary on the French in the United States.<sup>102</sup> In his manuscript history, Appleby wanted future generations to remember the "courage and intrepidity" of the people, recognizing in particular the women who ran messages and poured hot oil on the troops from upper story windows.<sup>103</sup> Poet J. C. Lord hailed the workers of France as the vanguard of the coming world:

At the voice of the Nations, like the roaring of a flood . . .  
The word of power is spoken, In accents loud and long . . .

The purple robe . . . is crushed beneath the tread,  
Of masses hunger driven,  
Demanding work and bread . . .

---

<sup>99</sup>Postgate, *The Story of a Year: 1848*, 165–93; Sperber, *The European Revolutions, 1848–1851*, 198–203; Helen Castelli, "June Days (22–26 June 1848)," *Encyclopedia of 1848 Revolutions*, retrieved on June 28, 1995, from <http://cscwww.cats.ohiou.edu/~Chastain/ip/junedays.htm>.

<sup>100</sup>Flanigan, Diary, July 14, 1848; Appleby, Autobiography and Journal, November 9, 1848, 244; Wilford Woodruff's Journal, December 28, 1848, 3:395; Sperber, *The European Revolutions, 1848–1851*, 201. T. A. B. Corley, *Democratic Despot: A Life of Napoleon III* (London: Barrie and Rockcliffe, 1961), 70–73, 75, makes the same suggestion.

<sup>101</sup>Appleby, "History of the Signs of the Times," July 13, 1848, 131–32.

<sup>102</sup>Gazley, *American Opinion of German Unification*, 284–309.

<sup>103</sup>Appleby, "History of the Signs of the Times," July 13, 1848, 131.

With pike and paving stone the maddened people arm,  
And Peace and Freedom fly the scene of tumult and alarm.

The Seine is running red  
Through the capitol [sic] of France,  
Over ramparts of the dead  
The cry is still advanced!

The terror, pain and sorrow  
Till the travail throes are past,  
But then a glorious morrow,  
And the promised rest at last . . .

King or Priest shall never  
Rebuild the broken wall,  
For thought is freed forever  
And Truth is now for all . . . <sup>104</sup>

William M'Ghie, a British member, intimated a less passive role for Mormons to play. Mormonism should never be "a cat's-paw in the hands of power for the enslavement of mankind," he wrote. M'Ghie swore to "effect the perfect freedom, both in mind and body" of his countrymen. And instead of religion being a "barricade to hinder the emancipation of mankind, [it] should be used as the only weapon to effect such a glorious object."<sup>105</sup> The metaphor of the barricade suggested revolutionary entrenchment—a call to stand and fight in Europe where the battle between progress and reaction would be decided.

Militancy among British Mormon leaders grew as the continental revolutions spread. The Church press office in Liverpool demanded reform, and President Orson Spencer may have conversed with British radical George Jacob Holyoake.<sup>106</sup> "Something seems to whisper that wisdom will be given to her Majesty's government," wrote Pratt during the Chartist demonstrations in April 1848, "to

<sup>104</sup>Lord, "King and Thrones Are Falling," [4].

<sup>105</sup>William M'Ghie, "Priestcraft in Danger: A Drama," *Millennial Star* 11 (April 15, 1849): 124.

<sup>106</sup>England, *Life and Thought of Orson Pratt*, 155. G. J. Holyoake, *By-gones Worth Remembering* (London: T. Fisher Unwin, 1905), does not men-

devise liberal things for the poor, whereby they may stand, at least for a season; and business gain a fresh impulse, and the righteous poor be thereby qualified to effect their deliverance."<sup>107</sup> Next month the whisper crescendoed. The Mormon press hectored Prime Minister John Russell and urged a solidarity movement of workers and the lower middle-class to solve the problems stalking British society. The government had lost its moral authority. The people owned the future.<sup>108</sup>

Disgust with the British government's ineffectiveness during the Irish potato famine intensified criticism of Russell's free-market policies.<sup>109</sup> In January 1847 the *Millennial Star* had excoriated the slow British response to the agricultural disaster, adding that Britain's "criminal and murderous tyranny" justified revolution.<sup>110</sup> Nineteen months later the Liverpool office of the *Star* supported a petition that would secure Irish tenure of the land, stop evictions, and abrogate the privileges of English landlords.<sup>111</sup> Appleby predicted that Irish nationalism would eventually win. The day "must surely come" when the "titled nobility" and "corrupt and wicked clergy" would pay for Britain's "sins and oppression."<sup>112</sup> Other observers—Wilford Woodruff, J. C. Lord, and Franklin D. Richards, Orson Pratt's succes-

---

tion Pratt, but Edward W. Tullidge suggests the relationship in his *History of Salt Lake City and Its Founders* (Salt Lake City: Edward Tullidge, 1890), Appendix, 33.

<sup>107</sup>Orson Spencer, "April 1, 1844," *Millennial Star* 10 (April 15, 1848): 120.

<sup>108</sup>"Alarming Conditions of the Country: Progress of Despotism," *Millennial Star* 10 (May 15, 1848): 146–47, reprinted from *Howitt's Journal of Literature and Popular Progress*. This periodical, published in London, 1847–48, was edited by William Howitt (1793–1879), a historian, poet, and social commentator. Contemporary liberals praised him beginning with his 1833 *The Popular History of Priestcraft*. At the time of the 1848 revolutions, Howitt and his wife Mary were making a transition from Quakerism to spiritualism. "William Howitt," retrieved on August 4, 2005, from <http://william-howitt.biography.ms/>.

<sup>109</sup>R. F. Foster, "Ascendancy and Union," in *The Oxford History of Ireland*, edited by F. Foster (New York: Oxford University Press, 1992), 166–67.

<sup>110</sup>"Ireland," *Millennial Star* 9 (January 1, 1847): 1.

<sup>111</sup>"Petition of Irish Farmers," *Millennial Star* 10 (1 July 1848): 208.

<sup>112</sup>Appleby, "History of the Signs of the Times," August 30, 1848,

sor as British mission president—thought like Appleby. They encouraged Irish nationalists to “throw off the British [sic] yolk” and destroy the land tenure system.<sup>113</sup>

In the midst of the Irish land question and the June Days uprising, Orson Pratt published *New Jerusalem, and Equality of the Saints: A Forecast of Events to Be Established by a Chosen and Dedicated People*. Pratt assumed that all governments would be “uprooted.” National distinctions would disappear, and a unified kingdom would replace the old order. Private property, the “foundation of . . . innumerable evils,” would yield to the “union of property” to foster the advancement of the Indians, assist the poor, fund immigration, and build the New Jerusalem.<sup>114</sup>

#### THE BITTERNESS OF REACTION

The imperial reaction that followed the “Springtime of the Peoples” in 1848 jarred the Latter-day Saint observers. Overwrought expectations rendered their fall from euphoria even more profound. In July 1849 Harvey Locksley Birch reviewed the previous eighteen months. Providence had sanctioned the street battles: the “civil wars, daring *emeutes*, and lawless, unconstitutional disturbances were not unapproved.” The upper classes had been “confounded” and God, in conjunction with the people, had struck “terror to the heart of kings.” But Birch was stunned by the conservative reaction. In July 1849 the disconsolate missionary wrote that infant revolutionary governments had been “shaken apart” by counterrev-

---

143–44; October 1, 1848, 160–61.

<sup>113</sup>Wilford Woodruff's *Journal*, December 28, 1848, 3:396; August 22, 1848, 3:363; Lord, “Kings and Thrones Are Falling,” [4]; Franklin Dewey Richards, “Ireland,” *Millennial Star* 12 (August 15, 1850): 254.

<sup>114</sup>Orson Pratt, *New Jerusalem, and Equality of the Saints: A Forecast of Events to Be Established by a Chosen and Dedicated People* (Liverpool: Orson Pratt, October 1, 1849), 58–64, reprinted (Salt Lake City: Parker P. Robinson, [1962?]), copy in L. Tom Perry Special Collections, Brigham Young University, Provo, Utah. This tract is similar to Orson Pratt's *New Jerusalem; or the Fulfillment of Modern Prophecy* (1849) but has added Section 16, “The Equality and Oneness of the Saints,” which first appeared in *The Seer*, July 1854, 289–300.

olution. Further resistance would be a mere act of despair.<sup>115</sup> From Scotland, Lyon memorialized the “honest” reformers who “dare[d] resist the sad yoke” only to be proscribed, hounded, and destroyed as “rebels.”<sup>116</sup> George Simms wrote a despairing yet hopeful poem: “Hark! a mighty clamor! a thousand nations rise.” The Russian army had routed the Hungarians, but another “day of vengeance dawneth” against the black forces of reaction.<sup>117</sup>

Reliance on Napoleon III as a republican stalwart likewise proved disappointing to Mormon observers.<sup>118</sup> Elected president in December 1848, Louis Napoleon’s intentions grew more transparent as he ignored his cabinet and surrounded himself with men determined to establish the Second Empire. After the coup of December 2, 1851, Curtis Bolton, then translating the Book of Mormon, walked the bullet-riddled sections of Paris. Inquiries of passersby confirmed for him that France had ceded its revolutionary leadership: “At a signal given the troops leveled and fired . . . The 33d Regiment of infantry seized a mother of children large in the family way. She had several knives in her possession. They stood her out and shot her. French soldiers did that, not [I]ndians.”<sup>119</sup> Hyde also believed that France had betrayed republicanism. “Affairs in France had reached the crisis so long dreaded,” but Hyde could not imagine that “twelve middle-aged Bonepartists” would survive the onslaught

---

<sup>115</sup>Harvey Locksley Birch, “Miscellanea and Letter to President Pratt,” *Millennial Star* 11 (July 1, 1849): 198. *Emeute* means violent outbreak or popular uprising.

<sup>116</sup>John Lyon, “It’s a Cauld Barren Blast that Blaws Nobody Good,” in *Harp of Zion*, 121–22.

<sup>117</sup>W. G. Simms, “The Desolation of Babylon,” *Frontier Guardian*, August 8, 1849, [4].

<sup>118</sup>Acclaim for Napoleon III is found in “The Coming European Revolution—Kossuth’s Next Movements,” *Frontier Guardian*, February 6, 1852, [4]; Appleby, “History of the Signs of the Times,” December 6, 1848, 170; “Prince Napoleon on European Affairs,” *Millennial Star* 28 (July 28, 1859): 478. Billington, *Fire in the Minds of Men*, 325, 340–41 notes that the rise of another Napoleon mesmerized European leftists as the supreme embodiment of the revolutionary synthesis.

<sup>119</sup>Curtis Edwin Bolton, Journal, December 5, 1851, holograph, 1, LDS Church Archives.



of 100 million aroused Frenchmen.<sup>120</sup>

Eliza Cook identified Napoleon III, Nicholas I, and “Constitution promising Frederick” as enemies of progress.<sup>121</sup> Additionally, the 1846 percussion rifle exemplified the new weapons that the ruling class could turn against the population. Quoting from a British colonial administrator, she detailed the effectiveness of rifled ordnance: “Garibaldi’s officers in scarlet were regularly shot down without seeing or hearing from which quarter the shot came. . . . [O]n the Boulevards of Paris, one of these new balls entered the forehead of a Socialist Representative the moment he appeared on the barricade with his red flag; in short, disguise it as one may, 500 men so armed are more than a match for any 3,000 men armed with the present British musket.”<sup>122</sup> Democracy, Cook declared, was the loser.

Spencer perhaps fell the furthest from the heady days of 1848. In 1853 he submitted a report informing Brigham Young that prospects for democracy in Europe were dim, let alone a mission in the German states. The revolutions had initially “humbled” the Hohenzollern dynasty but the “spirit of tyranny . . . has returned to the breast of the King of Prussia.” He in partnership with the Holy Quadrangle Alliance enforces the “absolutism . . . present on the whole continent of Europe.” Only death promised relief from the people’s “hell on earth.”<sup>123</sup>

<sup>120</sup>Orson Hyde, “Foreign News,” *Frontier Guardian*, January 9, 1852, [1]. Either Curtis Bolton or John Pack, sensing the tension a month before the coup, said the same in “A Sunday in Paris,” *Millennial Star* 13 (November 1, 1851): 330–31.

<sup>121</sup>Eliza Cook, “March of Civilization—Backwards,” *Millennial Star* 14 (May 22, 1852): 204.

<sup>122</sup>*Ibid.*, 205. Cook’s “Sir Charles Gray” was likely Sir George Grey (1812–98), explorer and governor of New Zealand and Cape Colony and advocate of social reform. See James Rutherford, *Sir George Grey, K.C.B., 1812–1898: A Study in Colonial Government* (London: Cassell, 1961). On rifled musket development between 1846 and 1851, see W. H. B. Smith, *Small Arms of the World: A Basic Manual of Small Arms*, 9th ed., revised and updated by Joseph E. Smith (Harrisburg, Pa.: Stackpole Books, 1969), 32–33.

<sup>123</sup>Orson Spencer, *The Prussian Mission of the Church of Jesus Christ of Latter-day Saints* (Liverpool: S. W. Richards, 1853), 5, 14–16, LDS Church Archives.

## CONCLUSION

In the pattern of revolution and reaction between 1848 and 1851, the Mormon observers opposed every value associated with the status quo. They ridiculed kings, cheered republicanism, and predicted the end of capitalism. Universal destruction and rebirth and sympathy with radical movements in Mormon pictorials belie a subconscious alignment with national romantics and denationalized social revolutionaries.

But the revolutions of 1848 fizzled, frustrating the end-of-history narrative again. Appleby's manuscript remained unpublished in Church archives as the failure of the revolutions sapped the desire to canonize 1848 as a momentous year in God's history. As usual, optimists pressed the reset button and recalibrated the millennium's unfolding. Eighteen forty-eight was not forgotten, however, as Mormon critics of political economy over the next seventy years would refer to the year's revolutionary aspirations to legitimate certain leftist ideas in their own time.<sup>124</sup>

In the meantime, another utopia was emerging. In spring 1851 a Mormon delegation visited the Great Exhibition held in London. The display of newfangled engines and mass-produced consumer goods demonstrated that middle-class achievement could be sustained only by mollifying the popular forces that had attacked the European dynastic and economic structure.<sup>125</sup> The diaries of Mormon visitors to the Crystal Palace record awe of material progress. The

---

<sup>124</sup>J. E. S. Russell, "The Poor," *Millennial Star* 27 (January 21, 1865): 38, suggested that British Mormons were disillusioned Chartists. See also Charles W. Nibley, "Competition," *Millennial Star* 40 (November 25, 1878): 741; Joseph M. Tanner, "The Nineteenth Century," *Improvement Era* 4 (January 1901): 162-63; Joseph A. Vance, "Growth and Development of Socialism," *Millennial Star* 71 (March 25, 1909): 178; B. H. Roberts, *The Life of John Taylor: Third President of the Church of Jesus Christ of Latter-day Saints* (1965; reprinted Salt Lake City: Bookcraft, 1989), 234.

<sup>125</sup>Peter H. Hoffenberg, *Empire on Display: English, Indian, and Australian Exhibitions from the Crystal Palace to the Great War* (Berkeley: University of California Press, 2001); Eric J. Hobsbawm, *The Age of Capital, 1848-1875* (New York: Charles Scribners' Sons, 1975), 5, 24-26, 32-33, 289. Several chartists, socialists, and continental revolutionaries were co-opted by the magnificence of the 1851 Great Exhibition. See Hoffenberg, *Empire on Display*, 127-28; Billington, *Fire in the Minds of Men*, 240, 336.

Mormon sightseers, used to “thinking big regarding their religion and its plan to cover the entire earth, were impressed by the immense building and the numerous exhibits demonstrating power and speed.”<sup>126</sup>

Throughout the remainder of the nineteenth century and into the twentieth, introspective churchmen and women continued to study world events. As they endeavored to place their religion in historical context they confronted two futures as different from each other as the neatly arranged galleries of the Crystal Palace and the ramshackle barricades of 1848. The rewards of capitalism and assimilation stood gleaming on the one hand. On the other lingered the revolutionary epiphany of a terrestrial kingdom of socioeconomic justice.

---

<sup>126</sup>T. Edgar Lyon, “In Praise of Babylon,” *Journal of Mormon History* 14 (1998): 54.

# MISSOURI'S FAILED COMPROMISE: THE CREATION OF CALDWELL COUNTY FOR THE MORMONS

*Stephen C. LeSueur*

FOLLOWING YEARS OF TENSION AND CONFLICT between the Mormons and their neighbors in Jackson and Clay counties, the Missouri legislature in 1836 carved out a Mormon county where they could establish their religious communities unmolested by outsiders. For more than a year thereafter, the Saints lived in relative peace, clearing land for farms, locating settlements, and filling up the newly created Caldwell County. But it was an uneasy peace, one that held only as long as the Saints remained primarily in Caldwell.

Mormon settlement patterns changed in the spring and summer of 1838 when large numbers of emigrants followed Joseph Smith to Missouri. As Caldwell's population swelled, the Saints began expanding into the surrounding counties. Many Missourians objected, claiming that the Mormons were breaking their promise to confine themselves to their own county. Cornelius Gilliam, a sometime minister and future state legislator, served on the Clay County committee that had helped found Caldwell County for the Saints. Later he claimed that the Mormons had promised "they would never settle above or north of the line of [Caldwell] county."<sup>1</sup> Alexander William Doniphan, one of the Saints' lawyers when they had been violently expelled from Jackson County in 1833, was the Clay County representa-

---

STEPHEN C. LESUEUR {stevelesueur@comcast.net} is a business writer and author of *The 1838 Mormon War in Missouri* (Columbia: University of Missouri Press, 1987).

<sup>1</sup>"Remarks of Capt. Gilliam," *Missouri Argus* (St. Louis), February 15,

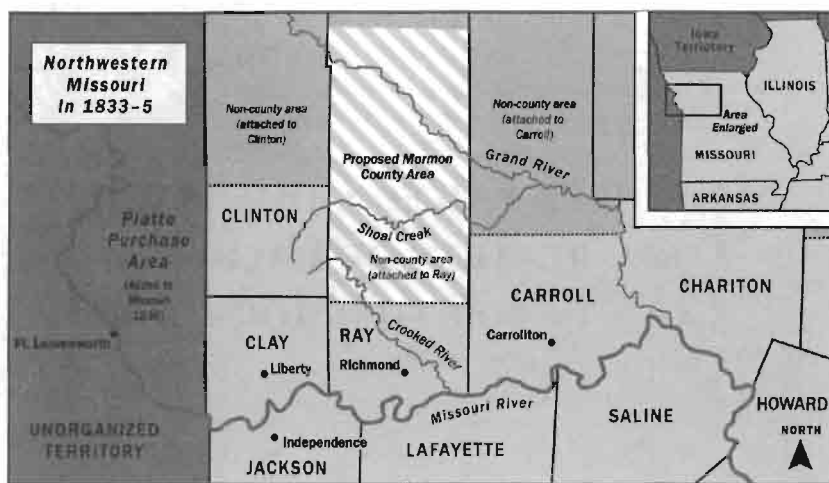

*Northwestern Missouri, 1833–35. The proposed “Mormon County” area north of Ray County according to the LDS petition to the Missouri legislature. Missourians may have hoped to steer the Mormons away from the Platte Purchase Area, then being added to Missouri. Map by John Hamer.*

tive who guided the bill through the legislature creating Caldwell County. He recalled many years later that the Mormons began having problems when “they commenced forming a settlement in Davis County, which under their agreement, they had no right to do.”<sup>2</sup> Throughout the summer and fall of 1838, when the Missourians threatened to drive the Saints from their settlements, many charged them with violating this agreement.

Curiously, the Mormon participants do not mention this alleged agreement, either to affirm or deny its existence. Is it possible they weren’t even aware that the Missourians believed such a bargain had been struck? And if the Mormons never agreed to settle only in Caldwell, what led the Missourians to believe they had?

Historians of this period often cite an 1886 county history as the source of this agreement. That history, published fifty years after

1839, 1.

<sup>2</sup>“Gen. Doniphan’s Recollection of the Troubles of That Early Time,” *Saint’s Herald* 28 (August 1, 1881): 230. This article reprints an interview with Doniphan in the *Kansas City Journal*, 12 June 1881.

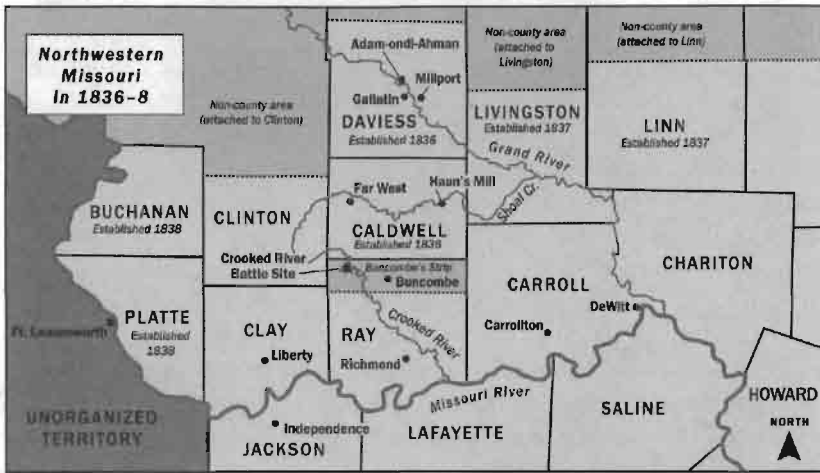

*Northwestern Missouri, 1836–38. The Missouri legislature authorized creation of Caldwell County for the Mormons, greatly reduced from the original proposal. The simultaneous creation of Daviess County blocked Caldwell expansion to the north and left Buncombe's Strip attached to Ray but not formally part of either county, between Caldwell and Ray. Map by John Hamer.*

the Mormon War of 1838, gives a precise summary of the alleged agreement: "The Mormons were to have undisturbed possession of the new county; they were to hold the county offices, send representatives to the Legislature, and in return for these privileges they were not to settle in any other county save by the express consent and permission, previously obtained, of two-thirds of the non-Mormon residents of the township in said county wherein they desired to make locations."<sup>3</sup> The history adds that, when the Mormons began settling in Carroll, Clinton, and Daviess counties in 1838, they did so "with the prior consent of the inhabitants then living where the set-

<sup>3</sup>*The History of Caldwell and Livingston Counties Missouri* (St. Louis: National Historical Company, 1886), 116–17. The history also states: "Every Gentile in the proposed new county that could be induced to sell his possessions at a reasonable price was bought out, and his place taken by a Mormon. The authorities of the church agreed that no Mormon should settle in any other county without the previous consent of the settlers already there" (104). There is no indication in this history of its authorship.

tlements were made.”<sup>4</sup>

Mormon historian B. H. Roberts cites this county history’s description of the agreement in his own history of these events. Although he does not dispute the agreement’s existence, Roberts said it could not be legally binding. The agreement “had to be an understanding between the Missourians and the saints, as no such agreement could be enacted into law.”<sup>5</sup> Leland H. Gentry, who wrote the most comprehensive history of these events, is uncertain whether the Mormons made this agreement. After citing the Caldwell County history, Gentry concludes: “One cannot say with certainty, in the absence of conclusive historical evidence, that the Mormons did not verbally promise to [secure permission] before settling any other area in the State.”<sup>6</sup> He returns to the point in his general conclusions: “It was claimed that the Saints agreed . . . not to settle any other area of the State without the express approval of at least two thirds of the present inhabitants. Conclusive historical proof for this claim is lacking, and the Latter-day Saints flatly denied having made it.”<sup>7</sup> Gentry did not cite, nor have I found, any statements from Mormons denying the existence of an agreement. In the most recent history of this period, Alexander L. Baugh cites the Caldwell County history and accepts its premise, saying it appears that initially, Church authorities agreed not to settle outside their own county without permission of two-thirds of the non-Mormon residents.<sup>8</sup>

Although I have also examined the alleged agreement in my history of the Mormon War, a closer look at the alleged agreement is

<sup>4</sup>Ibid., 118.

<sup>5</sup>B. H. Roberts, *A Comprehensive History of the Church of Jesus Christ of Latter-day Saints*, 6 vols. (Salt Lake City: Deseret News Press, 1930), 1:418–19.

<sup>6</sup>Leland H. Gentry, “A History of the Latter-day Saints in Northern Missouri from 1836–1839” (Ph.D. diss., Brigham Young University, 1965; reprinted Provo, Utah: Joseph Fielding Smith Institute for Latter-day Saint History and BYU Studies, 2000), 25.

<sup>7</sup>Ibid., 255.

<sup>8</sup>Alexander L. Baugh, *A Call to Arms: The 1838 Mormon Defense of Northern Missouri* (Ph.D. diss., Brigham Young University, 1996; reprinted Provo, Utah: Joseph Fielding Smith Institute for Latter-day Saint History and BYU Studies, 2000), 13.

beneficial for several reasons.<sup>9</sup> First, the negotiations between the Mormons and Missourians to establish a Mormon county provide a fascinating window into how the non-Mormon community struggled to balance the demands of majority rule versus respect for minority rights on the frontier. An examination of these events also illuminates the subsequent conflict, both in terms of the specific concerns that inflamed local passions and of the broader forces in American society that shaped the evolving conflict. Finally, this question—was an agreement made?—is an interesting one because the answer, like the answer to so many questions related to these events, depends ultimately upon subjective interpretations of incomplete and ambiguous source materials.

The idea of creating Caldwell County and thus making a permanent settlement for the Saints came about because of conflict with older residents in Clay County. After the Saints were driven from Jackson County in late 1833, a large portion of them found refuge in Clay. The Mormons' retreat to Clay was intended to be temporary—by both the Saints and Clay citizens—until the Saints were restored to their Jackson County homes. But the Saints' attempts at reclaiming their property failed; and with the passing years, Clay citizens grew increasingly anxious about the large number of Mormons in their midst. Violence threatened to erupt anew in 1836 when the Mormons stepped up their immigration into Clay, buying land and building homes in preparation for the return to Jackson County, which Joseph Smith had set for September 11 of that year.<sup>10</sup> Alarmed Clay citizens, fearful that their town would be destroyed by civil war, held a public meeting on June 29 at which they expressed their apprehensions. Joseph Thorp, a Clay County resident who attended the meeting, left this description:

---

<sup>9</sup>Stephen C. LeSueur, *The 1838 Mormon War in Missouri* (Columbia: University of Missouri Press, 1987), 19–27.

<sup>10</sup>Joseph Smith Jr. et al., *History of the Church of Jesus Christ of Latter-day Saints*, edited by B. H. Roberts (Salt Lake City: Deseret News Press, 6 vols. published 1902–12, Vol. 7 published 1932; reprinted by Deseret Book Company, 1976, paperback issue, 1978): 2:145, Joseph Smith, Letter, August 16, 1834. See also Max Parkin, "Latter-day Saint Conflict in Clay County," in *Regional Studies in Latter-day Saint Church History: Missouri*, edited by Arnold Garr and Clark V. Johnson (Provo, Utah: Brigham Young University, Department of Church History and Doctrine, 1994), 253–55.



It had been decided by the meeting that inflammatory speeches should not be made, and anyone departing from that rule should be called to order and set down; but it was plain to be seen that everything that was done or said was all on one side, and very little mercy manifested for the latter day saints.

There was one thing that stood out in bold relief—the saints must go; leave the county—all hands agreed in that.<sup>11</sup>

Following the meeting, the Missourians published a lengthy report in which they explained their reasons for wanting the Mormons to leave: “Their rapid emigration, their large purchases, and offers to purchase lands, the remarks of the ignorant and imprudent portion of them, that this country is destined by heaven to be theirs are received and looked upon, by a large portion of this community, as strong and convincing proofs that they intend to make this county their permanent home, the centre and general rendezvous of their people.”<sup>12</sup> Clay citizens contended that the Mormons were Easterners with different manners, customs, and habits, nonslaveholders who opposed slavery. The Mormons reportedly held constant communications with the Indian tribes immediately across the border—a charge the Missourians acknowledged could not be verified but which, given their vulnerability, they hesitated to ignore. And finally, the Missourians said the religious tenets of Mormonism were so different from traditional Christianity that the Saints would always excite deep prejudices in any populous county where they located. The report’s tone suggests that these citizens viewed themselves as moderates who were attempting to allay trouble, trouble that would be caused by the more extreme and lawless members of their community. They concluded:

We, therefore, in the spirit of frank and friendly kindness, do advise them [the Mormons] to seek a home where they may obtain large and separate bodies of land, and have a community of their own. . . .

We do not contend that we have the least right, under the Constitution and laws of the country, to expel them by force. But we would indeed be blind, if we did not foresee that the first blow that is struck, at this moment of deep excitement, must and will speedily involve every

---

<sup>11</sup>Joseph Thorp, *Early Days in the West: Along the Missouri One Hundred Years Ago* (Liberty, Mo.: Liberty Tribune, 1924), 79–80.

<sup>12</sup>*History of the Church*, 2:449–50.

individual in a war, bearing ruin, woe, and desolation in its course.<sup>13</sup>

Events moved quickly after this meeting. A committee of Clay citizens presented their resolutions to the Mormons the next day, June 30, and offered to help them find a place to settle. The Mormons discussed the issue among themselves and, following a meeting of the church elders on July 1 in Liberty, Clay County, drafted a petition strongly denying the various charges against them. Nevertheless, they agreed to leave Clay County, saying, "We accept the friendly offer verbally tendered to us by the committee yesterday, to assist us in selecting a location, and removing to it." The Clay citizens met the next day and appointed a ten-person committee to raise money to help the poor among the Saints move from the county and find a place "where they will be, in a measure, the only occupants; and where none will be anxious to molest them."<sup>14</sup> The non-Mormons likely regarded their assistance as both generous and as evidence of their desire to treat the Saints fairly. And so the stage was set for the move into Caldwell and the northern counties.

Gentry has pointed out that the Mormons had already been making plans to settle in the sparsely populated area of northern Ray County even before trouble in Clay County began.<sup>15</sup> When Ray County was created in 1820, it stretched from the Missouri River to the state's northern border, which Missouri shared with Iowa.<sup>16</sup> However, the provision creating Ray also established a northern boundary for the county proper; in 1836, the northern boundary of Ray County was established along the same northern boundary as Clay County. Legislators expected that the territory above this northern boundary eventually would be organized into new counties. But until those counties were created, the land north of Ray County proper was attached to Ray for civil and military purposes. It was in this region—north of the Ray County border but still attached to Ray at that time—that the Mormons were planning to settle.

In March 1836, for example, leaders of the Missouri church had been appointed by leaders in Kirtland to "purchase land for

---

<sup>13</sup>See *History of the Church*, 2:448–452, for the complete report.

<sup>14</sup>*Ibid.*, 2:453, 455.

<sup>15</sup>Gentry, *A History of the Latter-day Saints in Northern Missouri*, 19–20.

<sup>16</sup>*The History of Caldwell and Livingston Counties*, 101.

the Saints [and] seek a place for them.”<sup>17</sup> Beginning in May, these men began exploring northern Missouri for future settlement sites. Additionally, some Saints already had settled along Shoal Creek in what later would become Caldwell County, establishing a community known as Guyman’s Mill. In May and June—before the Clay meetings calling for the Saints’ removal—the Mormons purchased land in Caldwell in the names of Joseph Smith, Hyrum Smith, Oliver Cowdery, and John Corrill. Perhaps it was for this reason that the Mormon leaders considered relocating to this area when Clay citizens asked them to leave. In any case, on July 7 the Saints wrote to Governor Daniel Dunklin, informing him that they intended to move into the land north of Ray County and asking for his protection. Dunklin replied that popular will, not executive power, would dictate the Mormons’ fate among their neighbors. In a July 18 letter to Missouri LDS leaders, he wrote, “Public sentiment may become paramount to law; and when one man or society of men become so obnoxious to that sentiment as to determine the people to be rid of him or them, it is useless to run counter to it.”<sup>18</sup>

From all accounts, northern Ray County was sparsely settled relative to the other counties. Missourians regarded the Caldwell area unfavorably, largely because of its vast prairies, which were considered unsuitable for farming.<sup>19</sup> The first settler came to Caldwell in 1831; but until 1835, very little farming was attempted. The territory north of Caldwell, in what would later become Daviess County, was more favorably regarded, but it, too, was sparsely settled.

It is difficult to state with certainty the population at the time the Saints were contemplating their move into the region. The Caldwell County history says the Shoal Creek township—where Far West was subsequently established—probably had about 250 inhabitants at that time; but the rest of the county had very few.<sup>20</sup> Some were Mormon families who had already begun settling the area. Abner Blackburn, a young Mormon who moved with his family into Caldwell in 1837, said people could travel a day or more without

---

<sup>17</sup>Gentry, *A History of the Latter-day Saints in Northern Missouri*, 19.

<sup>18</sup>Quoted in *History of the Church*, 2:462.

<sup>19</sup>*The History of Caldwell and Livingston Counties*, 95–96.

<sup>20</sup>*Ibid.*, 103.

## CHRONOLOGY

November 1833: The Saints are driven from their homes in Jackson County and take temporary refuge in Clay County.

June 29, 1836: Clay County citizens meet and resolve that the Mormons leave the county.

June 30, 1836: A committee of Clay citizens meets with the Mormons to inform them of their resolutions.

July 1, 1836: The Mormons agree to leave Clay County.

July 2, 1836: Clay citizens create a committee to assist the Mormons in finding a new place to settle.

July 7, 1836: The Mormons inform Missouri Governor Daniel Dunklin of their plans to settle in northern Ray County territory.

July 23, 1836: John Corrill informs Ray County citizens of Mormon plans at a general county meeting; Ray citizens agree to Mormon settlements in northern Ray territory outside Ray County proper, if the older settlers do not object. The meeting appoints a nine-man committee to report at an August 3 county meeting.

July 25, 1836: Due to mounting opposition to new emigrants, the Mormons agree to move out of the Crooked River area in Ray County.

July 30, 1836: John Corrill and John Murdock meet with the Ray Committee. Corrill and Murdock mistakenly believe that Ray citizens will approve the Mormon move into northern Ray territory.

August 3, 1836: The Ray committee and Ray citizens meet and strongly oppose the proposed Mormon settlements in northern Ray territory. Ray citizens form committees of vigilance and vow to stop Mormon settlements.

August 8, 1836: W. W. Phelps and John Whitmer purchase the site of Far West.

November 29, 1836: Representative Alexander Doniphan of Clay County introduces the Saints' petition to create Caldwell County for the Mormons in northern Ray territory. The proposed size of Caldwell is cut by more than half due to opposition from settlers who do not want to be included in the new Mormon county.

December 29, 1836: Governor Lilburn W. Boggs signs legislation creating Caldwell County.

seeing another settler.<sup>21</sup> Wild game, nuts, berries, and honey were plentiful. Nearly all of the area's early settlers came from the South, mainly from Virginia, Tennessee, and Kentucky. "They were a rough, uneducated class, delighting in fighting and quarreling, but in the main hospitable," said Joseph McGee, a non-Mormon who moved to Daviess County with his family in the spring of 1838, regarding his early neighbors in that region.<sup>22</sup>

Before moving into the area, the Mormons sent John Corrill to Richmond, the Ray County seat, to apprise the citizens of their intentions and obtain their approval. Corrill, who served six years as a counselor to Bishop Edward Partridge, was one of the Mormons' most prominent leaders in Missouri and had been intimately involved in nearly every phase of Mormon history there. Later, he would be elected the first representative to the state legislature from Caldwell County. Corrill met with Ray citizens on July 23 at the courthouse, where a public meeting was held to discuss the Mormon situation. The minutes of this and a subsequent meeting were published the next month in the *Far West*, a weekly newspaper printed in Liberty, Clay County.<sup>23</sup>

Amos Rees, who was appointed secretary of the meeting, read a communication from the Clay County committee outlining the Mormon plan to settle north of Ray County—from Shoal Creek to the boundary of the state—and "requesting that the citizens of Ray would throw no obstacle in the way of their settlement there." Corrill explained that the reason for the Mormons' request was "for the purpose of procuring a resting place from persecution and to procure a home." After pledging that the Mormons would obey all laws, Corrill "requested that there might be an expression of the popular mind on the subject of their location." After some discussion, the Ray citizens voted unanimously that they would not object to Mormon settlements outside of Ray County "if the people among whom they settle did not object." The Ray citizens also appointed a nine-man committee to draft resolutions providing a clear expres-

---

<sup>21</sup>Abner Blackburn, Diary, 1, typescript, Perry Special Collections, Lee Library.

<sup>22</sup>Quoted in "Some of the Waste Places of Zion as They Appear Today," *Deseret News*, September 10, 1904, 23. See also LeSueur, *1838 Mormon War in Missouri*, 19–23.

<sup>23</sup>"Public Meeting," *Far West*, August 25, 1836, 1.

sion of everyone's views, and agreed to meet again on August 3.<sup>24</sup>

At about this time, mobs began threatening newly arrived Mormon emigrants who were camping on Crooked River in lower Ray County. Two days after Corrill met with Ray citizens, Mormon leaders met in Liberty at the home of W. W. Phelps. There they voted to send out two elders to raise money for about a hundred destitute families of the incoming party. They also advised the newly arrived Saints on Crooked River to leave and "scatter among the people" so as to avoid bloodshed.<sup>25</sup>

The Mormons then sent Corrill and John Murdock back to Richmond, where the two met on July 30 with the nine-man resolutions committee. It is important to note that this was not a mass meeting with all Ray citizens, because the committee apparently gave the Mormons a false sense of optimism regarding their plan to settle north of Ray. Corrill and Murdock made four main proposals on behalf of the Church:

1st. It is the desire of the "Mormons" to hold and enjoy equal rights with the citizens in purchasing land, etc., but

2nd. If Ray county requires the "Mormons" to leave it entirely, we feel disposed to do so on our part and urge and advise our brethren to do the same, and in that case we desire Ray county to grant a reasonable time to accomplish it in, so that those who have property in the county may dispose of it without sacrifice; and if the county requires it, we will also use our endeavors to stop "Mormon" emigration into the county

3rd. In consequence of the excitement and feelings of the people of Clay county, the "Mormons" have come to the conclusion (and it is now their intention) to settle in the territory north of Ray county, and we desire the consent of the people to let them do so.

4th. In the event of petitioning for a county on Shoal creek (which we will do so soon as is practicable) we are willing that the settlement on Crooked river, say six or eight miles north of the Ray line, should be attached to Ray county, if they desire it, and that we will abstain from making any settlements in the above stated territory of Crooked river until the matter is decided.<sup>26</sup>

The Mormons thus reiterated their intention to settle in the ter-

---

<sup>24</sup>Ibid.

<sup>25</sup>Donald Q. Cannon and Lyndon W. Cook, eds., *Far West Record: Minutes of the Church of Jesus Christ of Latter-day Saints, 1830-1844* (Salt Lake City: Deseret Book, 1983), 104-5, July 25, 1836.

<sup>26</sup>"Report of the Committee on the Part of the Mormons," Journal

ritory north of Ray County, where they would petition for the establishment of a county. They also announced that they intended to stay out of areas where local citizens objected to their presence, such as Ray County proper and the Crooked River territory north of Ray, which later became known as Buncombe's Strip.<sup>27</sup> These stipulations are significant because they suggest that the Mormons accepted, at least in principle, the concept of settling only in territory where existing settlers did not oppose them.

We do not have a formal record or minutes of how the Ray committee responded to these propositions, but Murdock came away believing that the Missourians approved the Saints' move into the Shoal Creek region, later to become Caldwell County. Here is Murdock's description of the meeting, written some years later but based on his journal from this period:

. . . on the [July] 30th, according to previous agreement, I, in company with Elder John Corroll met the Ray County Committee, and laid our complaint before them, and desired of them that if we could not have a home with them that they would grant us the privilege of settling on Shoal Creek in the Territorial part of the state; and after calling in a meeting of the county, they granted the latter but would not let us live with them.<sup>28</sup>

Murdock said he left for Shoal Creek on August 3, arriving there two days later, and that the Mormons immediately began selecting locations in that area. In fact, on August 8, less than a week later, John Whitmer and W. W. Phelps entered claims for land at what was to be-

---

History of the Church of Jesus Christ of Latter-day Saints, July 30, 1836, Archives of the Family and Church History Department, Church of Jesus Christ of Latter-day Saints, Salt Lake City (hereafter LDS Church Archives).

<sup>27</sup>Buncombe's Strip got its name from the town of Buncombe, since renamed Knoxville. The original 1820 law creating Ray County stipulated that Buncombe's Strip would be part of Ray; but an 1825 law said Buncombe's Strip would be incorporated in any new county created north of Ray. Thus, even before the Mormons proposed creating Caldwell, there existed some uncertainty about where this six-mile strip would be attached. The Missouri legislature added it to Ray County in January 1839, shortly after the Mormon War. *History of Caldwell and Livingston Counties*, 104-5.

<sup>28</sup>John Murdock, "An Abridged Record of the Life of John Murdock, Taken from His Journal by Himself," 16, n.d., typescript, Perry Special Collections, Lee Library.

come the town of Far West.

Corrill left no record of the meeting and describes the entire process for the Mormon move into Caldwell County in only the most general terms. He said the people of Clay helped the Mormons "to obtain a place of residence, which was in the territory of Ray county, since organised into the county of Caldwell, and the people in the vicinity consented to it." He does not say when the Ray citizens gave this consent.<sup>29</sup>

There is no reason to dispute Murdock's recollection of the outcome of the July 30 meeting with the Ray committee. However, something apparently changed between July 30 and August 3, when the committee reported back its findings and presented draft resolutions at a countywide meeting in Richmond. The tenor and outcome of this August 3 meeting was entirely different than Murdock's recollection suggests. Here is what the committee reported to Ray citizens at that meeting: "Your committee have reasons to believe that a very large majority of their fellow citizens living north of this county, proper, are decidedly opposed to the settlement of the Mormons in the country designated by the Clay county committee, and under these considerations they cannot concur with the committee of Clay county in advising the Mormons to remove to that territory."<sup>30</sup>

Thus, instead of endorsing the Mormons' move into northern Ray, as Murdock believed, the committee opposed it. The committee then offered a number of resolutions opposing Mormon settlements in Ray, and concluded that "the emigrating Mormons cannot, must not, nor shall not settle in Ray county." They resolved to prevent such settlement, "peaceably if we can, forcibly if we must."<sup>31</sup>

This resolution applied not only to Ray proper, but to all of Ray's northern territory as well. Ray citizens approved the resolutions and then formed committees of vigilance in each township to enforce the resolutions, including townships in northern Ray, such as Crooked River, Shoal Creek, and Grand River. Two of three anti-Mormon vigilantes from Shoal Creek, for example, were Francis McGuire and Wallace McAfee, municipal judges who lived near what would become Far West. Robert P. Peniston of Millport and William Bowman,

---

<sup>29</sup>John Corrill, *A Brief History of the Church of Christ of Latter Day Saints* (St. Louis: Printed for the Author, 1839), 26.

<sup>30</sup>"Public Meeting," *Far West*, August 25, 1838, 1.

<sup>31</sup>*Ibid.*



later a Daviess County sheriff, were two of the vigilantes from Grand River Township.

The anti-Mormon resolutions “were adopted almost unanimously—there being but five dissenting votes, in a crowded house,” according to the minutes.<sup>32</sup> It is difficult to explain how Murdock (and presumably Corrill) could have so completely misunderstood the citizens’ desires. Perhaps the two Mormon men left Ray before the meeting. But if that is the case, why did the members of the Ray committee, with whom Corrill and Murdock met on July 30, not inform them at that time of the widespread opposition? Most likely the committee members themselves did not discover until after their July 30 meeting with Corrill and Murdock that so many of their fellow citizens objected so strenuously to the Mormons. After all, Ray citizens initially endorsed the idea of Mormon settlements in northern Ray—conditional, of course, on the approval of their non-Mormon neighbors. Still, there is no record that Ray citizens sent a messenger notifying the Mormons of their resolutions. The Mormons were left to read them in the Liberty newspaper, *Far West*, which published the minutes of the meeting in its August 25 issue.

Two other points seem equally mysterious. There is no indication of what changed the Ray County citizens’ minds between the first meeting with the whole citizenry on July 23 and the meeting of adamant rejection on August 3. One can only guess that they received numerous complaints from citizens north of Ray saying they did not want Mormons settling among them. We must also guess that the Mormons eventually learned of these resolutions, which were published in the August 25 issue of the Liberty *Far West* newspaper and likely discussed throughout the upper counties. But there is no indication that the Mormons made any effort to hold another meeting, renegotiate, or even send a letter of inquiry. We have no record of a Mormon response to the August 3 meeting.

Instead, despite the obvious threat of armed resistance from Ray County, the Mormons went forward with their plans and began moving into the Caldwell County area, building up sites around Shoal Creek. Remarkably, no trouble ensued during that fall.

In November, Alexander Doniphan, one of the Saints’ lawyers in Jackson County and now a state representative from Clay County, presented the Saints’ petitions for creating a Mormon county. Ac-

---

<sup>32</sup>Ibid.

ording to the minutes of the Missouri House of Representatives for November, 29, 1836:

Mr. Doniphan presented the petition of sundry inhabitants of the territory attached to the county of Ray, praying the organization of a new county.

And also, another petition of sundry citizens of the same place, for the same purpose. . . .<sup>33</sup>

It is possible that the second petition came from non-Mormons requesting a second county, but I think it more likely that the both petitions came from the Mormons.

We do not have copies of the petitions describing the boundaries of the requested county, nor does the House *Journal* provide any details. But the county's basic outline can be inferred from a letter Doniphan later wrote to W. W. Phelps describing the legislative maneuverings required to establish Caldwell.<sup>34</sup> We likewise do not know who wrote the petitions—which Doniphan referred to as “your petition”—but the authors likely included Phelps and other Mormon leaders at Far West, such as Bishop Edward Partridge and John Corrill, whom Doniphan also mentions in his letter. The Mormons proposed forming a single county that bordered Ray County proper on the south and extended forty-eight miles to the north—more than twice the size of present day Caldwell County. The House referred the petitions to a three-person committee consisting of Smallwood Noland of Jackson County, Waller Head of Randolph, and Doniphan as its chairman.

Several points about the Mormons' proposal stand out as significant. First and foremost, the proposal ignores completely the discussions between the Mormons and Ray County citizens, including the statements and resolutions published in the Liberty *Far West* newspaper. For example, the proposed Mormon county included territory where the existing settlers—or at least a large number of

---

<sup>33</sup>*Journal of the House of Representatives, of the State of Missouri, at the First Session of the Ninth General Assembly, Begun and Held at the City of Jefferson, on the Twenty-first day of November, in the Year of Our Lord One Thousand Eight Hundred and Thirty-Six* (Bowling-Green, Mo.: Salt River Journal, 1837), 86.

<sup>34</sup>Alexander W. Doniphan, Letter to W. W. Phelps, January 8, 1837, *Journal History*.

them—had said they did not want Mormons settling among them. This includes the Crooked River territory (or Buncombe's Strip) immediately north of Ray and the Grand River area. Second, the Mormons had already told the Missourians they would not settle the Crooked River region, but now they apparently wanted their county to encompass these disputed townships. It seems impossible that the Saints did not know about the anti-Mormon resolutions adopted by Ray citizens more than two months earlier. After all, Ray citizens made no secret of their feelings.

Third, it is interesting that Doniphan was pushing this legislative proposal for a large Mormon county, despite local opposition. While his position was motivated, at least in part, by his own sense of fairness and tolerance for a persecuted minority, his support for the Mormon county also represented the desire of Clay citizens in his home district to rid themselves of the Mormons. Michael Riggs points out that Missourians regarded the land in the Platte territory north of Clay County and only recently annexed by the state as more promising for farming than Caldwell County. Riggs therefore argues that when Doniphan and other Clay citizens offered to help the Mormons settle in northern Ray, they were also motivated by a desire to keep the Mormons from settling the more desirable Platte lands. The Platte region's close proximity to Fort Leavenworth, which lay directly across the Missouri River, provided settlers there with ready access to a growing market for produce and labor.<sup>35</sup> Thus, Doniphan's proposed legislation not only would get the Mormons out of Clay but also steer them away from the coveted Platte territory.

The proposal creating a large Mormon county was thwarted by opposition from settlers in the northwestern counties and their supporters in Jefferson City, including newly elected Governor Lilburn W. Boggs and Smallwood Noland of Jackson County, according to Doniphan. "The petitions of the people of North Grand River, the statements of the citizens of Ray, the influence of her member, and the prejudices of Noland, Boggs, Jeffery [sic], McLelland, etc., were to be combated," Doniphan said regarding

---

<sup>35</sup>Michael Riggs, "The Economic Impact of Fort Leavenworth on Northwestern Missouri, 1827–1838: Yet Another Reason for the Mormon War?" *Restoration Studies IV*, edited by Marjorie B. Troeh and Eileen M. Terril (Independence: Herald Publishing House, 1988), 124–33.

the legislative battle.<sup>36</sup> Doniphan said the opposition of North Grand River settlers forced him to modify the original proposal and report a bill creating two counties instead of one, Daviess County in the north for non-Mormons and Caldwell County in the south for the Mormons. Each county formed a twenty-four-mile square.

Then, after the bill was reported, additional opposition from Ray County citizens forced Doniphan to eliminate the six-mile strip of land known as Buncombe's Strip from the southern portion of the proposed Mormon county. As a compromise measure, Doniphan persuaded the legislature not to attach Buncombe's Strip to Ray County. Instead, it remained unorganized territory under Ray's civil and military jurisdiction. In the end, the Mormons received a county that ran only eighteen miles north and south—less than half the size of what they originally envisioned.

"I did not and could not succeed as you wished, or as you might have expected, in fixing the boundaries of your county," Doniphan told Mormon leaders.<sup>37</sup> Governor Boggs signed into law the bill creating Caldwell and Daviess counties December 29, 1836.

Significantly, Doniphan suggested to Phelps that the Mormons might increase the size of their county in the future by adding Buncombe's Strip:

I made a compromise by which I left that six miles just as it had heretofore been attached to Ray for civil and military purposes only. This was better by far than adding it to Ray, for when they [the Ray citizens] reflect awhile, they will become afraid to add it, lest it would endanger their seat of justice [Richmond], and as it forms a part of neither of the counties, it will be as open for subsequent legislation as it now is or ever has been. Perhaps in two more years, if the Citizens of Ray become a little alarmed about the county seat, and your people may get a foothold in this fraction, you may have it added easily. I know the present limits of your county are contracted, and I regret it much, but you are aware of the prejudices and ignorance that are to be found and combatted everywhere in this county on this subject, as well with the legislature as with the "common herd." In time, I hope you may add to its limits, when prejudices have subsided and reason

---

<sup>36</sup>Doniphan, Letter, January 8, 1837.

<sup>37</sup>Ibid.

and common sense have again assumed the helm.<sup>38</sup>

Doniphan thus tacitly implied that the Mormons could still settle in the six-mile strip of land, thus paving the way for its future incorporation into Caldwell County. However, he did not recommend that the Mormons try similar tactics in other counties outside of Caldwell, perhaps because they did not exist in the same limbo as did Buncombe's Strip.

It does not seem unreasonable to conclude that all of this wrangling between the Mormons and the Missourians was aimed at (1) creating a county exclusively for the Mormons, and (2) circumscribing the boundaries of the Mormons' settlements. In other words, the Mormons could settle in Caldwell, but not in the surrounding counties. That was the initial goal of the Clay and Mormon committees: to find a sparsely settled tract of land that the Mormons could have to themselves and where the settlers already there would not object to their presence. That is why the Mormons at first offered not to settle in certain locations and also why the legislature reduced the size of Caldwell County, thus accommodating the wishes of those who did not want to be part of the new Mormon county.

This certainly was Doniphan's conclusion. Recalling these events many years later, Doniphan commented: "I was a member of the legislature and drew the bill organizing Caldwell county for the Mormons exclusively, and the offices of the county were given to their people. The new county filled up very rapidly, and they made great progress in agricultural and other improvements. They continued to live prosperously and industriously until the Summer of 1838, when Joseph Smith came out from Ohio and soon after they commenced forming a settlement in Davis [sic] county, which, under their agreement, they had no right to do. This occasioned difficulties with the citizens of Davis county."<sup>39</sup>

Because Doniphan made this statement in 1881, more than forty years after these events, it is possible he was simply remembering something that had become part of Missouri's historical memory. But Cornelius Gilliam, who also participated in the formation of

---

<sup>38</sup>Ibid.

<sup>39</sup>"Gen. Doniphan's Recollections," 230. His memory was inaccurate on one point. Joseph Smith had actually left Kirtland in January and arrived in Missouri in mid-March, not in the summer.

Caldwell County, made a similar assertion just a few months after the Mormon War. Gilliam was one of three commissioners appointed by the state legislature to help select the seats for Caldwell and Daviess counties; he also negotiated with the non-Mormons in Caldwell, helping to persuade them to sell out to the Mormons and move away. In February 1839, after the Mormon War was concluded and the Saints were traversing the state toward the Illinois border, Gilliam, a state senator, told the legislature:

I was one of the individuals appointed by the citizens of Clay county to accompany the Mormons in their removal, and assist them in seeking an unoccupied place to settle in. The county of Caldwell was thought the most favorable position, and I went with my colleague and negotiated with the citizens, and they agreed to sell out and dispose of their lands. They did sell out their lands, the Mormons purchased them, and soon occupied the territory.

The Mormons, on their settlement of Caldwell, made this agreement: that they would never settle above or north of the line of said county. . . . But, sir, utterly regardless of their solemn vows and pledges, they persisted in emigration and were rapidly filling Davies county, thus violating all their pledges and solemn obligations.<sup>40</sup>

We need not necessarily accept Gilliam's comments at face value. The Mormons regarded him as one of their chief persecutors during the 1838 troubles. As a colonel in the state militia, he had led Missouri troops through Daviess County, where they drove Mormons from their land and burned their homes. He might have been trying to justify these activities to fellow legislators.

But other Missourians also raised the issue of the agreement—and did so during the conflict itself. The earliest statement I have found is a document created on August 7, 1838, when Carroll County citizens were protesting Mormons' settling in the town of DeWitt. They drafted resolutions asking nearby counties to help them expel the Mormons from Carroll County, and the preamble reads:

It was distinctly understood, and expressly agreed upon by said Mormons and the other citizens of the upper part of the State of Missouri, that they (the said Mormons) might select a tract of country un-

---

<sup>40</sup>"Remarks of Capt. Gilliam," *Missouri Argus* (St. Louis), February 15, 1838, 1.

inhabited, and locate themselves in peace, but they should not intrude upon the citizens of any of the adjoining counties, agreeably to which contract the Mormons first settled that tract of country now known as Caldwell county, which met with the approbation of the counties adjoining. . . . said Mormons have broken the covenant so by them made, and are now settling in Carroll county, contrary to the express wishes of the citizens thereof.<sup>41</sup>

A week after the Carroll meeting, a county resident repeated this charge in a private letter: "There is considerable stir in this and the adjoining counties at this time in regard to a sect who call themselves Mormons[,] there are several families of them who have contrary to the expressed wish of the citizens of this county settled in it."<sup>42</sup>

Less than two weeks after the Carroll meetings, the resolutions accusing the Mormons of violating the agreement were reprinted in the *Missouri Republican* of St. Louis and circulated throughout the upper counties. Fears quickly arose that the Mormons were spilling into other counties as well. In mid-September, the *Western Star* (Liberty, Missouri) wrote: "It is also true, that when the Mormons left this [Clay] county [in 1836], they agreed to settle in, and confine themselves to a district of the country, which has since been formed into the county of Caldwell; but they have violated that agreement, and are spreading over Daviess, Clinton, Livingston and Carroll. Such a number had settled in Daviess, that the old inhabitants were apprehensive they would be governed soon by the Revelations of the Prophet, Joe Smith, and hence their anxiety to rid themselves of such an incubus."<sup>43</sup>

Some Missourians pointed out, as had the citizens of Ray County, that such an agreement was unlawful and that they could not legally confine the Mormons to one county. But again, the idea was firmly fixed that such an agreement had been made.

As noted earlier, the *History of Caldwell and Livingston Counties* said the agreement stipulated that the Mormons could move into another county if they first obtained permission from two-thirds of the

---

<sup>41</sup>"The Mormons in Carroll County," *Missouri Republican* (St. Louis), August 18, 1838, 2.

<sup>42</sup>Arthur I. H. Bradford, Letter to Thomas G. Bradford, August 13, 1838, typescript copy, LDS Church Archives.

<sup>43</sup>"Mormon Difficulties," *Missouri Republican*, September 22, 1838, 2; reprinted from the *Western Star* (Liberty), September 14, 1838.

non-Mormon residents in the township where they intended to move. No contemporary accounts refer to this two-thirds requirement. However, a history of Carroll County published forty years after these events, said that the county held a formal vote on whether to allow the Mormons to stay.<sup>44</sup> After the Mormons began moving into DeWitt, Carroll citizens put the issue on the ballot in the August 1838 general election and voted overwhelmingly to expel the Saints. Reportedly only six to eight votes favored the Mormons. The history does not say how many votes were cast against the Mormons, but election returns published in the *Missouri Argus* show that more than 240 Carroll citizens voted in that election—suggesting that the vote was decidedly against them.<sup>45</sup>

What do the Mormons say about this alleged agreement? Unfortunately, almost nothing at all. The only commentary I have found related to the subject is a statement by Willard Snow, a Mormon, who wrote in an undated petition: “There appeared an existing principle riveted [riveted] in the mind of the sitizens of those upper counties of Mo that the mormons should not have the privilege of settling unmo-lested in any other county but Caldwell.”<sup>46</sup> I could find no other statements alluding to an agreement. Even John Corrill, who was more actively involved than any other Mormon leader in negotiating the creation of Caldwell County, fails to mention an agreement in either his own history of these events, as already quoted, or in his petition to Congress for redress.

It is likewise puzzling that other Mormons also fail to mention an agreement. Many, like Joseph Smith, arrived in Missouri long after Caldwell had been created and so perhaps knew nothing about the alleged agreement. But did they not know about the charges raised

---

<sup>44</sup>“History of Carroll County, Missouri,” in *An Illustrated Historical Atlas of Carroll County, Missouri* (n.p.: Brink, McDonough & Co., 1876), 13. The information for the portion of the Carroll history dealing with the Mormon War, including the record of the vote, was provided by A. C. Blackwell, a non-Mormon, who served as secretary at the Carroll vigilante meetings.

<sup>45</sup>Information on election returns in *Missouri Argus*, September 15, 1838, 3.

<sup>46</sup>Willard Snow, undated petition, in Clark V. Johnson, ed., *Mormon Redress Petitions: Documents of the 1833–1838 Missouri Conflict* (Provo, Utah: Brigham Young University, Religious Studies Center, 1992), 714.



against them during the conflict? Mormon leaders made a point of publicly rebutting other accusations made by Missourians. For example, they strongly denied that they were abolitionists or were tampering with the Indians. One would think they would have responded to accusations that they violated their agreement, if for no other reason than to assert that the agreement was illegal, bigoted, unenforceable, nonexistent, an outright lie—anything to counter arguments that they had broken a pledge.

Although the Missourians apparently believed that the Mormons agreed to confine themselves to Caldwell, the Mormons continued to buy land and locate in the surrounding counties, particularly in Daviess County, which the Saints originally wanted to be part of the Mormon county. The Saints had prominent settlements on Marrowbone and Honey Creeks south of Grand River. Here John L. Butler, John D. Lee, Perry Durfee, and some of the others who later were involved in the Gallatin election battle on August 6, 1838, had made their homes. Some Mormons had begun purchasing land here as early as February 1837. Another Daviess settlement was a site just north of Grand River, settled by Lyman Wight in the spring of 1837, at what later became Adam-ondi-Ahman. Yet Daviess citizens, or at least a substantial portion of them, initially did not want Mormons settling among them. In August 1836, they had protested Mormon plans to move into their area, then lobbied the legislature in November 1836 against being included in the Mormon county. They succeeded in having Daviess created as a separate county. Consequently, when Wight and other Mormons continued locating there anyway, some of the older settlers put up notices and visited the new Mormon emigrants, telling them to leave the county, in July 1837.<sup>47</sup> The delegation included Adam Black, William Bowman, and William Peniston. “They protested against their [the Mormons] settling among them, yet they had not the power to banish them from their borders,” an unnamed citizen wrote regarding Daviess settlers’ oppo-

---

<sup>47</sup>W. W. Phelps wrote from Far West on July 7, 1837: “Public notice has been given by the mob in Daviess county, north of us, for the Mormons to leave that county by the first of August and go into Caldwell.” *History of the Church*, 2:496. Several Missourians, including William Bowman and Adam Black, filed statements about their effort to persuade the Mormons to leave. In Johnson, *Mormon Redress Petitions*, 746–49.

sition to the Mormons.<sup>48</sup> Although the Mormons refused to leave, the trouble apparently died down quickly. When Joseph Smith visited Far West in November 1837, he began making plans for additional settlements in Daviess and throughout northwestern Missouri. From that point on, Mormon leaders intermittently sent out parties to scout additional lands.

Thus, less than a year after the creation of Caldwell County, Joseph Smith and other Mormon leaders—including John Corrill—were already laying plans for expansion outside the county.<sup>49</sup> Moreover, on April 26, 1838, shortly after Joseph Smith moved to Missouri, he issued a revelation stating that not only should the Saints build up Far West, but that “other places should be appointed for stakes in the regions round about, as they shall be manifested unto my servant Joseph, from time to time” (LDS D&C 115:18). Mormon plans for expansion continued as if the Saints did not know or did not care that the Missourians thought they had agreed to stay in Caldwell. Or perhaps, in the minds of the Saints, the April revelation gave divine sanction to expansion, thus superseding any agreement that might have existed.

Despite the expansion into Daviess and other counties, there was relatively little trouble between the two groups until July 1838—about a year and a half later. In fact, both Mormons and Missourians commented on the remarkably improved relations. Given the later explosion, why did peace prevail when the Mormons were expanding outside Caldwell almost from the beginning? The answer is that the Saints were still settling almost exclusively in Caldwell County. After Caldwell was created, most non-Mormons sold their homes and property to the Saints, who established numerous farms and small communities.

Far West, the county seat, was laid out with large blocks and wide streets in anticipation of a thriving town. By the summer of 1838 the town contained 150 log cabins, with perhaps an equal number under construction, four dry-goods stores, three family groceries, six black-

---

<sup>48</sup>Unnamed correspondent, Elk Horn, Ray County, *Missouri Argus*, November 8, 1838, 2.

<sup>49</sup>John E. Thompson, “The Initial Survey Committee Selected to Apportion Lands for Gathering in Daviess County, Missouri (1837–1838),” in *Restoration Studies III*, edited by Maurice L. Draper and Debra Combs (Independence: Herald House Publishing, 1986), 305–13.

smith shops, two hotels, and a large school. Far West's population eventually reached nearly 2,000 and Caldwell County's population was perhaps 5,000 at that time.<sup>50</sup> The Mormon settlements outside of Caldwell, however, were relatively sparse and non-threatening to the non-Mormon population.

In short, it appears that in other counties, even in Daviess where many citizens initially opposed the Mormons, the majority of the settlers came to accept the relatively small Mormon presence. Here is what Ephraim Owen, a Mormon settler, said about his experience in Daviess: "The citizens of Davis county made no objection to the Mormons settling amongst them, but, on the contrary, [they] said (as the writer can witness) that they were willing they should settle amongst them; they said, in times past they had objections, but were now satisfied that the reports of the bad character of the Mormons were false."<sup>51</sup> Owen's statement, written in December 1838, is consistent with the recollections, newspaper accounts, and histories written by both Mormons and non-Mormons. Despite the underlying tension, relations between the two groups improved, and various accounts say that non-Mormons in the upper counties lent the Mormons money to purchase land, lent horses for farm work, provided them with corn and other provisions for their farms, and let them purchase supplies on credit at their stores.<sup>52</sup> The *Elders' Journal*, a monthly periodical edited by Joseph Smith and published in Caldwell County, reported in May 1838 that "the Saints here are at perfect peace with all the surrounding inhabitants, and persecution is not so much as once named among them; every man can attend to business without fear or excitement, or being molested in any wise."<sup>53</sup>

Conditions probably were not equally favorable everywhere or in every encounter. John Corroll, for example, remarked that in

---

<sup>50</sup>LeSueur, *1838 Mormon War in Missouri*, 35–36.

<sup>51</sup>Ephraim Owen, Jr., "Memorial, December 20, 1838," House of Representatives Executive Documents, vol. 346, no. 42, p. 1, 25th Congress, 3d Session (Washington, D.C.: U.S. Government Printing Office, 1839).

<sup>52</sup>LeSueur, *1838 Mormon War in Missouri*, 24–27.

<sup>53</sup>"Far West, May, 1838," *Elders' Journal* 1 (July 1838): 34. No author is identified, but internal references suggest that it was a member of the First Presidency. At least some portions of the article were written on May 4, according to the article itself. George W. Robinson, who kept Joseph Smith's diary for this period, wrote that the church presidency spent part of Friday,

Daviess County, the Saints “lived as peaceably with their neighbors as people generally do”—a somewhat cryptic assessment that was meant, perhaps, to acknowledge a certain level of misgivings. But Corrill also felt that relations were improving in northwestern Missouri. After the creation of Caldwell County, “friendship began to be restored between them [the Mormons] and their neighbors, the old prejudices were fast dying away, and they were doing well, until the summer of 1838,” Corrill said.<sup>54</sup>

These relatively peaceful relations were disrupted by three developments within Mormonism, all coinciding with the arrival of Joseph Smith and Sidney Rigdon from Kirtland in the spring of 1838. The most important was the rapid expansion of Mormon settlements into other counties. Under Smith’s direction, the Saints began expanding Adam-ondi-Ahman and also colonizing DeWitt in Carroll County. In addition, the Saints in May began locating farms both north of Diahman and south along the Grand River as part of an ambitious plan to secure land between these northern sites and Far West.<sup>55</sup> In fact, it seems possible that the Mormons intended to make settlements starting in Diahman and running along the Grand River through Livingston and Carroll counties all the way to DeWitt, where the Grand River empties into the Missouri.<sup>56</sup> As mentioned earlier, one of the newspaper articles accusing the Mormons of breaking their agreement complained not only about Mormon settlements in Daviess, but also said that they were spilling over into Clinton, Livingston, and Carroll counties.

In some respects, the Mormons’ push into the surrounding counties merely reflected the continuation of earlier plans. But the ambitious expansion begun after Joseph Smith’s arrival in Missouri also bore his unmistakable personal stamp. The Mormon prophet

---

May 4, writing history, and part of Saturday, May 5, writing for the *Elders’ Journal*. George W. Robinson, “The Scriptorium Book of Joseph Smith Jr. President of the Church of Jesus Christ of Latterday Saints in All the World,” May 4 and 5, 1838, LDS Church Archives.

<sup>54</sup>Corrill, *A Brief History*, 28, 26.

<sup>55</sup>Robinson, “Scriptory Book of Joseph Smith Jr.,” Friday, May 18, 1838, and Sunday, [May 20, 1838].

<sup>56</sup>Wayne Lewis makes this argument in “Mormon Land Ownership as a Factor in Evaluating the Extent of Mormon Settlements and Influence in Missouri” (M.A. thesis, Brigham Young University, 1981), 67-68.

gave the effort new urgency by infusing the northern Missouri settlements with theological significance. Far West, he reportedly said, was the place where Cain slew Abel. Near Wight's home in Daviess County, he renamed Spring Hill "Adam-ondi-Ahman" and proclaimed that Adam and Eve had made their home there after being driven from the Garden of Eden. Even more significantly, Smith issued a revelation stating that Adam-ondi-Ahman was the place where Adam—the great Ancient of Days spoken of by the prophet Daniel in the Bible—would return to usher in Christ's second coming.<sup>57</sup>

Because time has tempered the Saints' millennial fervor, historians tend to overlook its importance in shaping Mormon beliefs and behavior. Although difficult to measure quantitatively, the motivating power and influence of the Saints' millennial expectations can be seen in many of the early documents, such as Joseph Smith's *History of the Church* and the *Millennial Star*, whose authors routinely noted earthquakes, wars, and disasters in far-flung places across the globe as evidence to the Saints that the end scenes were close at hand. Missouri itself embodied those expectations. It was here God told the Saints to gather, to build their temples and homes, to create City of Enoch-like communities, to flee to Zion for refuge, and to make for themselves a shelter from the impending and certain doom.

Did Joseph's pronouncements about the theological significance of northern Missouri add to that millennial fervor? Consider nineteen-year-old Benjamin F. Johnson. After arriving at Adam-ondi-Ahman, Johnson was somewhat discouraged at the land assigned to him in the developing city, because as a young, single man, he had to make do with a rocky plot that was decidedly inferior to the prime locations staked out by the married brethren. But a few days later, the Prophet Joseph walked over Johnson's lot, pointed to the scattered rocks, and told his party that these were the very stones Adam used to build his altar. Here, said Joseph, Adam blessed the multitude of his descendants, and here he would again sit as the Ancient of Days. "Then," said Johnson, "I was not envious of anyone's

---

<sup>57</sup>The Cain reference is in "The Reed Peck Manuscript," September 18, 1839 (Salt Lake City: Modern Microfilm Co., n.d.), 5. Peck was a disaffected Mormon when he wrote this account of his Missouri experiences. The information about Adam-ondi-Ahman comes from LeSueur, 1838 *Mormon War in Missouri*, 29–30.

choice for a city lot in Adam-ondi-Ahman.”<sup>58</sup> Furthermore, Alanson Ripley published a letter urging the Saints to gather to Zion: “When we look upon this beautiful situation,” he said regarding Diahman, “with the transcendent landscape which surrounds it . . . , we are ready to say truly this is like unto the land which the Lord our God promised to the Saints in the last days.”<sup>59</sup>

These descriptions of Diahman illustrate how quickly and successfully Joseph made northern Missouri the new centerpiece of his kingdom-building plans. The Saints were originally pushed into Caldwell because they had failed in their goal to return to Zion (Jackson County) and because, for the most part, the Missourians did not want the county’s prairies. But whatever disappointment and dissatisfaction the Saints may have felt regarding these northern Missouri settlements disappeared under the spell of Joseph’s enthusiasm for the new territory, which he imbued with biblical and millennial significance. The Mormons regarded it as holy ground and their expanding settlements as a fulfillment of God’s millennial plan. How fitting it must have seemed that, in northern Missouri, the history of man would end where it all began. The Mormons believed they were on God’s errand, that he was directing their activities, that he wanted them to succeed, would help them to succeed, and would bless and protect them in these endeavors. Any opposition to their plans, as they saw it, was obviously the work of the devil.

The rapid expansion of Mormon settlements outside Caldwell County was just one of three developments that strained relations between the Mormons and their neighbors in mid-1838. The second was the rise of the Danites, a Mormon vigilante group formed in June 1838 to protect the Church from both internal and external enemies. The Danites attracted some of the Prophet’s most loyal followers. After the group expelled several prominent dissenters and their families from Far West, its numbers and influence increased throughout the summer and fall. And as tensions between the Mormons and their neighbors rose, Missourians cited the Danites as evidence of the Mormons’ violent and criminal aspirations in the upper Missouri counties.

The third development, related to the second, was the decision by Mormon leaders to take an aggressive, proactive stance against

---

<sup>58</sup>Johnson, *My Life’s Review* (Independence: Zion’s Printing & Publishing Co., 1947), 35–36.

<sup>59</sup>Alanson Ripley, *Elders’ Journal* 1 (August 1838): 52.

non-Mormons who opposed their presence in the upper counties. This spirit animated Sidney Rigdon's Fourth of July oration in which he declared that if any mobs came against the Mormons, the Mormons would fight in self-defense and would wage a war of extermination against their enemies.<sup>60</sup>

Some Mormons, like John Corroll and Reed Peck, as well as many Missourians, viewed the Danite organization and Rigdon's oration as evidence of a militant spirit that, rather than quieting opposition to the Mormons' expansion plans, would create just the opposite effect by provoking fears and reawakening the suspicions and animosities of the past. Indeed, Clay County's *Western Star* expressed surprise at Rigdon's speech, saying, "Until the 4th of July we heard of no threats being made against them, in any quarter. The people had all become reconciled to let them remain where they are, and indeed were disposed to lend them a helping hand."<sup>61</sup> Several Mormon leaders, including future Mormon prophet Brigham Young, later said that the speech unnecessarily provoked much of the subsequent anti-Mormon violence. "Elder Rigdon was the prime cause of our troubles in Missouri, by his fourth of July oration," Young said.<sup>62</sup>

Trouble began in Carroll County shortly after Rigdon's speech, although not as an immediate consequence of it. Rather, Carroll citizens objected to a Mormon settlement at DeWitt begun in early July 1838.<sup>63</sup> Interestingly, it was two non-Mormons, David Thomas and Henry Root, who had invited the Mormons to purchase lots in the town. Root, who owned the lots, likely thought a strong Mormon presence would stimulate trade and create a thriving community. One of the two Mormon men who first moved to DeWitt with his family was John Murdock, who had negotiated the creation of Caldwell County for the Mormons. His willingness to settle in a new county suggests that either he did not believe the Mormons had agreed to confine themselves to Caldwell, or he believed the invitation extended by Thomas and Root signaled the approval of the non-Mormon community.

---

<sup>60</sup>LeSueur, *1838 Mormon War in Missouri*, 47-53.

<sup>61</sup>"Mormon Difficulties," *Missouri Republican*, September 22, 1838, 2; reprinted from *Western Star*, September 14, 1838.

<sup>62</sup>Quoted in LeSueur, *1838 Mormon War in Missouri*, 51.

<sup>63</sup>For the DeWitt events, see Baugh, "A Call to Arms," 65-81; Gentry, *A History of the Latter-day Saints in Northern Missouri*, 102-9; LeSueur, *1838 Mormon War in Missouri*, 54-58; 101-11.

Root and Thomas, however, had not obtained approval from other Carroll citizens. During the month of August 1838, almost immediately after the Mormons arrived, Carroll citizens began holding meetings, passing resolutions demanding that the Mormons leave the county, sending out calls to other counties for assistance to expel the Mormons, publishing the proceedings of their meetings, and voting to expel them. Among the reasons they gave was their assertion that the "Mormons have broken the covenant so by them made, and are now settling in Carroll county contrary to the express wishes of the citizens thereof."<sup>64</sup>

Anti-Mormon sentiment also erupted in August in Daviess County, where the Mormons were laying plans for a large settlement at Adam-ondi-Ahman. Not surprisingly, local settlers who vocally opposed the initial Mormon settlements in 1836 and 1837 (the Peniston family, Adam Black, and William Bowman) figured prominently in the new round of trouble that led to the Mormons' expulsion.

In conclusion, we may now review the evidence on the question: Did the Mormons promise to settle only in Caldwell County? The Missourians certainly thought so. Statements from Alexander Doniphan, Neil Gilliam, Carroll County citizens, and contemporary newspaper accounts assert the existence of an agreement. The Mormons clearly understood that Caldwell was being created just for them and explicitly agreed not to move into at least some areas where local settlers objected to their presence. In short, the *appearance* of an agreement existed, an agreement never formally signed but implicit in all the negotiations and events leading to the establishment of Caldwell County. In the minds of the Missourians, that agreement was this: You can have Caldwell County and run it any way you like, but you cannot settle in places outside Caldwell where you are not wanted.

However, there is no evidence that Mormon leaders agreed to restrict their settlements to Caldwell. Although they must have understood that such was the Missourians' desire and intent when they created Caldwell County, the Mormons treated it as an unjust, unenforceable expectation, not as an agreement which they had pledged to comply with. Subsequent events unfolded in a way that probably led Mormon leaders to believe the agreement could be modified and

---

<sup>64</sup>"The Mormons in Carroll County," *Missouri Republican*, August 18, 1838, 2. When the Missourians finally expelled the Saints from DeWitt in October, they forced out Root and Thomas with them.



eventually ignored. After all, Alexander Doniphan, the Clay representative who sponsored the legislation creating Caldwell County, encouraged the Mormons to settle in the six-mile strip of land south of Caldwell so that they might get a toehold and eventually annex the land to their county. In Daviess County north of Caldwell, the Saints quickly began settlements and encountered only minimal opposition. In DeWitt, they were invited to settle by the non-Mormon owner.

Some Missourians viewed with alarm the Mormons' gradual expansion efforts. But as long as most Mormons remained in Caldwell County, their presence provoked little more than grumbling. From the Mormons' perspective, the lack of strong opposition and the willingness of some Missourians to sell and move out probably bolstered the notion that the agreement to remain in Caldwell was not hard and fast and that, if they acted prudently, they could continue moving into other regions in the upper Missouri counties.

Moreover, neither Joseph Smith nor most Mormons were party to the negotiations creating Caldwell County. By 1838, they probably felt little reason to abide by an agreement that had been forced upon them. Joseph Smith's revelation calling for expanding settlements in Daviess County, identified by the Prophet as sacred ground where Adam and Eve had dwelled—and where Adam would shortly return in millennial glory—made clear that God's grand plan for the region superseded the Gentiles' expectations and desires.

This study suggests an area for further research. With an estimated 12,000 to 15,000 Mormons either in Missouri or on their way, Joseph Smith in the spring of 1838 made plans to establish settlements throughout northwestern Missouri. There was, of course, nothing illegal about the Mormons' gathering in Missouri. Consequently, many historians have regarded the opposition to their settlements as motivated primarily, if not solely, by religious prejudice. And while prejudice undeniably played a large role, historians also should take a closer look at one of the Missourians' primary fears: being overrun by the Mormons.

I am not referring to Mormon militancy or alleged illegal activities, but simply to the fact that an enormous group of newcomers was moving in so rapidly that they threatened to displace or swallow up local citizens. A common complaint voiced by Missourians was a fear expressed by local settlers to John D. Lee, a Mormon resident of Daviess County, that the Mormons "will be so strong in a few years

that they will rule the country as they please.”<sup>65</sup> Would 12,000 Saints be enough to raise such fears? What if the number had been 25,000? At what point should the historian conclude that the large number of emigrants alone was destined to bring trouble, regardless of the participants’ religious views or how peaceably inclined either group might be?

Asking this question in no way implies that the Mormons deserved expulsion. Rather, it attempts to look dispassionately at an important dynamic in the Mormon-Missouri experience. Did other American communities experience similar conflicts due to a large influx of newcomers? How were the dynamics and resolutions of those conflicts similar to and different from the Mormon experience in Missouri? Such a study could greatly add to our understanding of Mormon history.

Finally, the wrangling over the creation of Caldwell County—the 1836 meetings in Clay County and Ray County, the negotiations between the Mormons and their neighbors, and the subsequent debate in the state legislature—revealed deep-seated prejudices against the Saints. Many citizens would have been happy to see the Mormons leave the state right then. But this wrangling also evidences a genuine effort by the Missourians to come up with an acceptable solution to the Mormon problem. The creation of Caldwell County evinces a willingness by non-Mormons to let the Saints live among them, but not in such numbers that the Mormons would dominate their communities.

It was a compromise aimed at satisfying the Mormons’ rights and desire to settle in Missouri, while at the same time satisfying the desire of existing settlers to be undisturbed by Mormon kingdom-building. It was an imperfect compromise, as compromises are, because neither side got completely what it wanted. But the Missourians did give the Mormons something. Unfortunately, it wasn’t enough. It would be difficult to say what would have happened had the Mormons confined their settlements to Caldwell. But apparently they never intended to anyway. From a historical perspective, then, Mormon plans to expand throughout northern Missouri were probably doomed from the beginning—but not because of the Danites and Mormon violence against dissenters, nor because of Rigdon’s Fourth

---

<sup>65</sup>John D. Lee, *Mormonism Unveiled; or The Life and Confessions of the Late Mormon Bishop John D. Lee* (St. Louis: Bryan, Brand, & Co., 1877), 67.

of July oration and the subsequent Mormon militancy, though these contributed to and shaped the eventual conflict. Mormon plans were doomed because their western Missouri neighbors would not tolerate the expansion of the Mormon kingdom outside of Caldwell County.

Judge Austin A. King, who presided over the Richmond preliminary hearing in November 1838 and who committed Joseph Smith and other Mormons to jail, offered a similar theory regarding the root cause of the Mormons' troubles. Shortly after the hearing, he told Missouri Governor Lilburn Boggs:

If the Mormons would disperse and not gather into exclusive communities of their own, I think, with the exception of a few of their leaders, the people might be reconciled to them, but this they utterly refuse to do. They tell me that it would amount to an abandonment of their creed and religion, for they believe, you know, in the gathering together of the Saints, and that they shall come out from the world. Suggest the matter to them as I have done, for the sake of their peace and safety, and they will give you many scriptural reasons why they should not do so.<sup>66</sup>

Mormons regarded gathering and kingdom-building as divine imperatives; Missourians regarded these activities as a threat to their communities. The two positions could not be reconciled.

---

<sup>66</sup>Hon. A. A. King to the Governor, December 23, 1838, in *Document Containing the Correspondence, Orders, &C in Relation to the Disturbances with the Mormons; and the Evidence Given before the Hon. Austin A. King* (Fayette, Mo.: Office of the Boon's Lick Democrat, 1841), 95–96.

# ARTOIS HAMILTON: A GOOD MAN IN CARTHAGE?

*Susan Easton Black*

FOR JOSEPH AND HYRUM SMITH, Carthage, Illinois, was a scene of broken promises, illegal arraignment, incarceration, and ultimately, martyrdom. Once whispered in secret, accusations of riot, stemming from the destruction of the *Nauvoo Expositor* press, turned to treason. Unfounded rumors were now shouted in the press and from ear to ear. Apostates openly declared that the Smith brothers would not leave Carthage alive: “*There was nothing against these men; the law could not reach them but powder and ball would.*”<sup>1</sup> Their vow was brutally realized the afternoon of June 27, 1844.

In the wake of assassins’ bullets, there was one Carthage resident whose kindness, although perhaps more compelled than heartfelt, has been overlooked. Only a few statements about this kindness have been recorded. One of them is from Lucy Mack Smith: Joseph’s and Hyrum’s “bodies were attended home by only two persons, save those that went from this place [Nauvoo]. These were Brother Willard

---

SUSAN EASTON BLACK {susan\_black@byu.edu} is a professor of Church History and Doctrine at Brigham Young University and a past Associate Dean of General Education and Honors. With Andrew Skinner, she co-edited *Joseph: Exploring the Life and Ministry of the Prophet* (Salt Lake City: Deseret Book, 2005).

<sup>1</sup>“Report came to Joseph that William and Wilson Law, Robert D. Foster, Chauncey L. Higbee and Francis M. Higbee” had made this claim. Joseph Smith, et al., *History of the Church of Jesus Christ of Latter-day Saints*, edited by B. H. Roberts, 7 vols., 2nd ed. rev. (Salt Lake City: Deseret Book, 1948 printing), 6:566; emphasis in original.

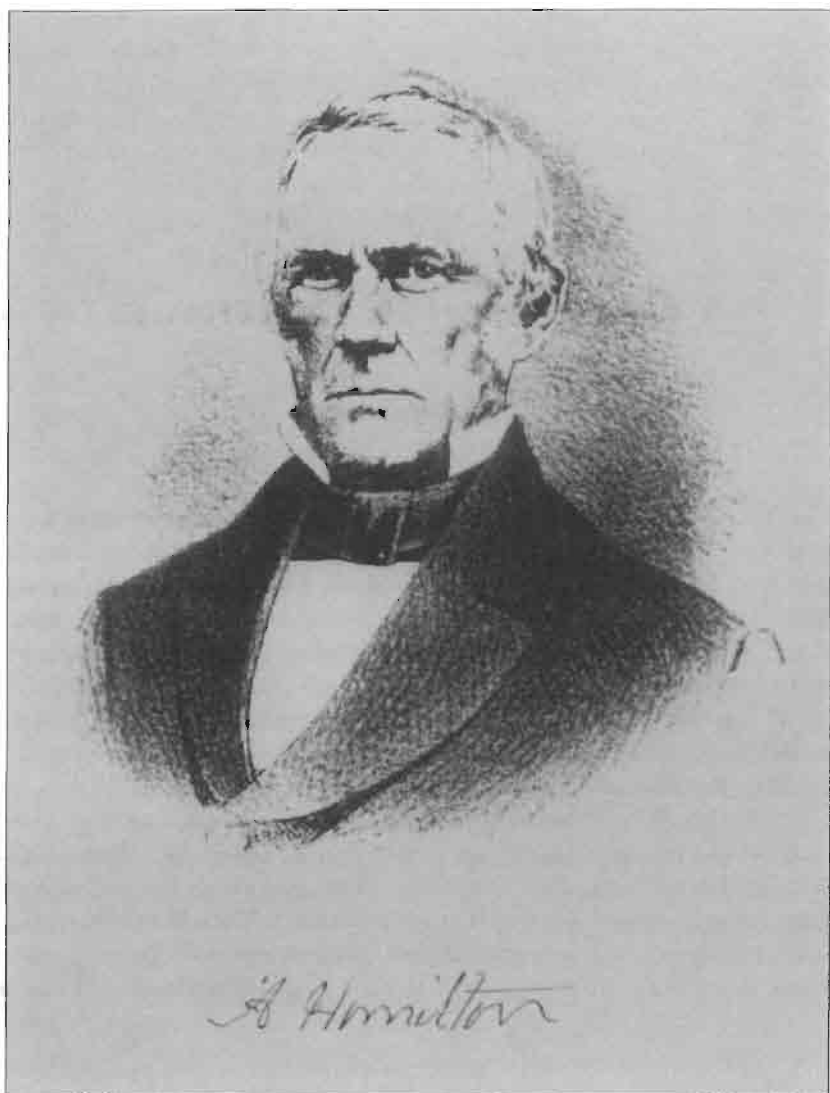

*Artois Hamilton, proprietor of Hamilton House, Carthage Illinois. Thomas Gregg, History of Hancock County, Illinois (Chicago: Chas. C. Chapman & Co., 1880).*

Richards and a Mr. Hamilton.”<sup>2</sup> In contrast, much has been written in LDS circles of Richards’s extraordinary leadership in late June 1844. This article is a long overdue acknowledgment of the life of Artois Hamilton, a prominent citizen of Carthage, and an invitation to readers to determine whether he was sympathetic to the plight of Joseph and Hyrum Smith or merely a coerced participant of the horrific events of June 21–28, 1844.

### EARLY YEARS

Artois Socrates Hamilton, son of Gad Hamilton and Anna (or Ann) Moore Hamilton, was born August 15, 1795, in the farming community of Granville, Hampden County, Massachusetts, where he grew up. In 1822, he moved to Johnstown, Montgomery County, New York. Five years later at age thirty-one, on February 22, 1827, he married Atta (also Alva) Bentley of Mayfield, a suburb of Johnstown. She, the daughter of Elisha and Bethsheba Bentley, like Hamilton, had spent her youth in a farming community.<sup>3</sup>

As the young couple began life together, their hopes and dreams leaped beyond rural New York. Hamilton hoped that his employment in the tanning business and as a river raftsman would bring him prosperity. Failing to realize his economic dreams after several years of hard work, he bade farewell to his wife and four children in April 1835 and ventured to the Midwest in search of a more promising future for his family.<sup>4</sup>

With a horse team and a wagon, he wandered for nearly two months from village to village in Ohio, Indiana, and Illinois, seeking the perfect locale. Although some communities showed prom-

---

<sup>2</sup>Scot Facer Proctor and Maurine Jensen Proctor, eds., *The Revised and Enhanced History of Joseph Smith by His Mother* (Salt Lake City: Bookcraft, 1996), 457.

<sup>3</sup>The exact date of Atta’s birth is unknown. The record on FamilySearch.com estimates that she was five years younger than Artois Hamilton.

<sup>4</sup>*Biographical Review of Hancock County, Illinois, containing Biographical and Genealogical Sketches of Many of the Prominent Citizens of To-day and Also of the Past* (Chicago: Hobart Publishing Company, 1907), 683. The couple’s four children were Marvin, born in 1828, William Ransom (1829), Amelia Ann (1831), and John Dallas (1833). Marvin, Amelia, and John died during an 1851 cholera epidemic in Carthage.

ise of rich soil and future prosperity, it was not until June 22, 1835, when Hamilton visited Carthage, Hancock County, Illinois, that he finally put down roots.<sup>5</sup> Sleeping for weeks in his wagon, scavenging for food, and feeding his horses on cut prairie grass did not diminish his enthusiasm for the fledgling community. He secured a lease on a small dwelling and sent word to his wife and children to join him. Without undue difficulties, they arrived on August 14, 1835. At least some members of the extended family likewise joined him there: both of his parents and two sisters also died in Carthage.

From the start, Hamilton's choice of Carthage proved fortuitous. Within the first year, he had purchased and was supervising work on two large farms. His bountiful harvest from these farmlands not only put money in his pocket but enabled his sons to attend private schools until he needed extra farmhands. William, his second son, recalled setting aside textbooks more than once to assist with farming operations on the family acreage.<sup>6</sup>

#### HOTEL OWNER AND PROPRIETOR

By spring 1836 Hamilton had purchased a small log house on the corner of Main and Washington Streets near the center of Carthage. Wanting to supplement his income and believing himself naturally hospitable, he added rooms to the existing house until it was

---

<sup>5</sup>In 1833 the General Assembly of Illinois designated Carthage the county seat of Hancock County. Th. [Thomas] Gregg, *History of Hancock County, Illinois, Together with an Outline History of the State, and a Digest of State Laws* (Chicago: Chas. C. Chapman & Co., 1880), 235–36. On January 13, 1825, Hancock County was formed from unorganized territory and named in honor of John Hancock (1737–93), the first governor of Massachusetts, a member of the Continental Congress, president of the Congress from 1775 to 1777, and the first man to sign the Declaration of Independence. John Drury, *This Is Hancock County, Illinois: An Up-to-Date Historical Narrative with County Map and Many Unique Aerial Photographs of Cities, Towns, Villages and Farmsteads* (Milwaukee, Wisc.: Loree Company, 1955, 46). No record has survived of how Hamilton's given name was pronounced. It could have been either Anglicized as "Ar-toys" or, given the regional French influence along the Mississippi River, "Ar-twaz."

<sup>6</sup>*Biographical Review of Hancock County, Illinois*, 683.



*This well-known photograph of Hamilton House depicts the second hotel by that name that Artois Hamilton built in Carthage. No known photograph has survived of the first Hamilton House in which Joseph and Hyrum Smith stayed before their assassinations. B. H. Roberts, A Comprehensive History of the Church of Jesus Christ of Latter-day Saints, 6 vols. (Provo, Utah: BYU Press, 1965 printing), 2:251.*

large enough to entertain paying travelers.<sup>7</sup> Although no photograph or detailed description of the hotel has survived, it was a two-story building (since Governor Ford addressed the militia from an upstairs window) and had a dining area on the main level. It was apparently spacious enough that Joseph Smith could rent two rooms for his party in June 1844.

---

<sup>7</sup>The address of the Hamilton House is 630 Main Street in Carthage's modern street system. On this site in the 1960s stood a two-story house that was remodeled to accommodate the Town and Country Flower Shop. Dan Gillogly, a former art teacher at Carthage High School, was employed in the shop. In recalling the history of the location, he said, "The flower shop was on the exact location where the Hamilton House had been. Glen Poulter purchased the existing house and lot in 1963. After a few years, he sold the house and lot to Betty Hunter, who managed the floral shop for two or three years until it burnt to the ground." Since 2003, the site has been an empty corner lot on Main Street next to the First Community Bank. Interview with Dan Gillogly, October 12, 2002, Carthage, Illinois, typescript in my possession.



It was not long before the Hamilton House was viewed by locals and travelers alike as the first village hotel in Carthage and Hamilton as the owner and proprietor. Whether referred to as the "Hamilton Tavern" or the "Hamilton House," the hotel was open for business by 1836.

Owning the "only available accommodations between Springfield and Nauvoo" that provided sleeping quarters and meals meant guaranteed daily revenues.<sup>8</sup> And with Carthage being a long stop on the stagecoach route that conveyed travelers from the state capitol to the seat of Hancock County, there were few nights Hamilton did not host a handful of guests. Carthage in the late 1830s and early 1840s had a few hundred residents, a few stores and shops and two or three saloons. In all of Hancock County, there were only 1,782 heads of household in 1840; even by 1860, the population of Carthage was only 2,099.

Preparing rooms, meals, and a tidy atmosphere for these guests kept him and his family scrambling. Although his thriving hotel business added greatly to the domestic burdens of each family member, it was particularly heavy on his wife. But Atta proved herself an able and cheerful hostess both day and night despite giving birth to two more children, Mary (1836) and Elisha Bentley (1838).<sup>9</sup> Artois's parents and sisters may have also provided help with the guests.

The house was always filled to capacity during the third week in May and October when the county circuit court held its sessions in Carthage. The defense attorneys, known as circuit riders, typically stayed at Hamilton House.<sup>10</sup> Furthermore, hundreds of visitors, mostly farmers from throughout the county, arrived to shop, take care of legal business, swap news, or just observe the entertainment of the court sessions.<sup>11</sup> The entertainment began even before the arrival of a "circuit rider." Visitors stood for hours near the city center or Hamilton House, anticipating the theatrical entrance of the riders into

---

<sup>8</sup>John E. Hallwas and Roger D. Launius, *Cultures in Conflict: A Documentary History of the Mormon War in Illinois* (Logan: Utah State University Press, 1995), 86.

<sup>9</sup>Gregg, *History of Hancock County, Illinois*, 717.

<sup>10</sup>Marvin S. Hill and Dallin H. Oaks, *Carthage Conspiracy: The Trial of the Accused Assassins of Joseph Smith* (Urbana: University of Illinois Press, 1979), 1. The judge was a resident of Carthage.

<sup>11</sup>In 1833 the first courthouse was constructed on the south side of

Carthage. "A popular lawyer could not swing out of the saddle and brush the dust from his tailcoat before he was surrounded by a noisy chorus of litigants [in Carthage] shouting descriptions of their controversies and seeking his services," wrote former attorney Dallin H. Oaks and historian Marvin S. Hill.<sup>12</sup>

Although attorneys Thomas Ford, Stephen A. Douglas, Orville H. Browning, Archibald Williams, and Abraham Lincoln once rode the circuit, few were as well known in Carthage courts as James W. Woods of Keokuk, Lee County, Iowa Territory. "He ought to have been an actor," some said. Others were more specific—"A comedian. He would doubtless have attained eminence in that line, for he had a keen sense of the ludicrous, and was sometimes insensibly ludicrous in himself." He "told stories that made the hearers laugh, joked with friends without offending them, and always wore a cheerful face."<sup>13</sup> Another was Hugh T. Reid of Fort Madison, Lee County, Iowa Territory. "He loved controversy and was logically tenacious" and not afraid to exhibit his talents in the courtroom.<sup>14</sup> His lackluster partner, Edward Johnstone,<sup>15</sup> didn't have "a great love" for the legal profession and chose to retire when Carthage courtroom crowds showed in-

---

the town square. Six years later, the second courthouse was built in the center of the square. The present county courthouse was finished on October 21, 1908. *Ibid.*, 211.

<sup>12</sup>*Ibid.*, 2; see also John Dean Caton, *The Early Bench and Bar of Illinois* (Chicago: Chicago News Company, 1893), 223.

<sup>13</sup>James W. Woods practiced law on the Illinois and Iowa sides of the Mississippi River. He said, "I was a good deal in Illinois and I had practice in what they call the Military tract and used to attend court from Pike County, Illinois Territory, as far north as they could go, where there were any inhabitants, up to Fulton County and Bureau. I was in Illinois perhaps half the time." In Edward H. Stiles, *Recollections and Sketches of Notable Lawyers and Public Men of Early Iowa: Belonging to the First and Second Generations, with Anecdotes and Incidents Illustrative of the Times* (Des Moines: Homestead Publishing, 1916), 260, 264.

<sup>14</sup>Reid formed a law partnership with Edward Johnstone. Their law firm "became one of the most prominent in the State" of Iowa. *Ibid.*, 329.

<sup>15</sup>"Mr. Johnstone said he often met and talked with [Joseph Smith] and got letters from him, which, after reading, he threw away. This he afterwards regretted, as he would have been glad to have written of Smith from his own personal knowledge, and to have had the letters to show the man-

difference to his well-crafted speeches. But Johnstone aside, the circuit court was so filled with drama, contention, and theatrics that observers did not complain about sleeping in wagon boxes or haystacks so they could attend the sessions.

Outside the courtroom, and certainly in the public rooms of the Hamilton House, men swapped yarns, traded horses, shared news of steamboats on the Mississippi, and argued politics to their complete satisfaction. Artois and Atta Hamilton moved among their guests, providing food and drink, and, we may suppose, managing to recognize the range of opinions respectfully but without taking partisan sides with any, lest they offend paying customers. The week of June 21–28, 1844, challenged this role for Artois Hamilton.

#### PRELUDE TO ASSASSINATION, JUNE 21–24, 1844

On June 21, the family hotel turned from a cozy overnight haven for travelers and circuit riders into the official headquarters of Governor Thomas Ford.<sup>16</sup> That day Hamilton welcomed the governor and Joseph's attorney, James W. Woods of Keokuk. By the next day, Mormon apostates Wilson and William Law, Robert Foster, and the Higbee brothers had paid for their quarters and were receiving the same cordiality.<sup>17</sup> Two days later Hamilton extended a welcome to the Prophet Joseph Smith and his brother Hyrum, securing two rooms for them about five minutes before midnight.<sup>18</sup> Hamilton's awkward position of hosting the governor, Mormon apostates, and Church leaders must have strained him and his family, while simultaneously adding stature to the growing historical importance of his establishment.

Joseph Smith's arrival at the hotel immediately attracted the at-

---

ner of man the prophet was and how he wrote." He eventually left law to engage in banking in Keokuk, Lee County, Iowa. *Ibid.*, 327.

<sup>16</sup>From the Hamilton House, letters were exchanged between Ford and Joseph Smith. *History of the Church*, 6:525, 533–42. Letter of Thomas Ford, Governor and Commander in Chief, Letter "To the Honorable the Mayor and Common Council of the City of Nauvoo," June 21, 1844, *ibid.*, 6:521: "Having heard of the excitement in this part of the country, and judging that my presence here might be necessary to preserve the peace and enforce the laws, I arrived at this place this morning."

<sup>17</sup>*Ibid.*, 6:543, 560.

<sup>18</sup>*Ibid.*, 6:559.

tention of the militia, then camping in the public square. They moved as a group to the hotel, and among them were two of Artois's sons, sixteen-year-old Marvin and fifteen-year-old William.<sup>19</sup>

James Woods, attorney-at-law, witnessed the Mormon prophet's arrival at the Hamilton House. "I was there at the time, in an upper room fronting the street, talking with the Governor," wrote Woods. "[There were] about five hundred of the soldiers encamped on the public square . . . clamoring for a sight of Joe and Hyrum Smith." Although "these men belonged to the militia that had been organized by the Governor, . . . it was for the most part an organized mob. The McDonough and Brown County men were rather quiet; the worst were the Adams and Hancock men."<sup>20</sup>

"Where's the d—d prophet? Stand away you McDonough boys and let us shoot the d—d Mormons! G—d d—n you, old Joe, we've got you now! Clear the way, and let us have a view of Joe Smith, the prophet of God! He has seen the last of Nauvoo! We'll use him up now," were the profane threats that pierced the air.<sup>21</sup>

Governor Ford, wanting to diffuse the situation, raised a window sash and spoke to the undisciplined men: "Gentlemen, I know your anxiety to see Mr. Smith, which is natural enough, but it is quite too late tonight for you to have that opportunity; but I assure you, gentlemen, you shall have that privilege tomorrow morning, as I will cause him to pass before the troops upon the square, and I now wish you, with this assurance, quietly and peaceably to return to your quarters."<sup>22</sup> "Hurrah for Tom Ford," was heard from the men.<sup>23</sup>

#### JUNE 25–27, 1844

At 8:30 the next morning, Governor Ford, true to his word, ordered the militants to "form a hollow square on the public ground near the Court House."<sup>24</sup> Forty-five minutes later, he invited Joseph and Hyrum Smith to walk with him before the assembled men, almost as if in review, accompanied by their attorney.

<sup>19</sup>Ibid., 7:143; Hill and Oaks, *Carthage Conspiracy*, 20.

<sup>20</sup>Stiles, *Recollections and Sketches*, 269.

<sup>21</sup>Quoted in B. H. Roberts, *The Life of John Taylor* (Salt Lake City: Bookcraft, 1963), 129–30; See also *History of the Church*, 6:559.

<sup>22</sup>Ibid., 130; see also *History of the Church*, 6:560.

<sup>23</sup>*History of the Church*, 6:560.

<sup>24</sup>Ibid., 6:562.

The Prophet requested a few moments of private conversation with the governor before the public exhibition, but Ford refused. According to historian B. H. Roberts, at 9:53 A.M. Joseph and Hyrum walked before “drunken rabble [who] had collected in the street in front of the Hamilton House.”<sup>25</sup> Attorney James Woods recorded: “I was told afterwards that there were at least a hundred men loaded to shoot Joe Smith . . . I was between Smith and the militia. . . . They told me afterwards that but for me Joe would have never passed through the lines alive; they did not want to hurt me; I could name nearly every one of them. I was merely the attorney, but I felt good when I got back to the Governor’s headquarters” at the Hamilton House.<sup>26</sup> By 10:05 the Smith brothers were back in their quarters in the hotel.

Militia officers, unsatisfied by this review, demanded an audience with the Mormon prophet at the hotel. According to B. H. Roberts, “President Smith took occasion to ask them if there was anything in his appearance to indicate that he was the desperate character his enemies represented him to be.” The officers replied, “No, sir, your appearance would indicate the very contrary, General Smith; but we cannot see what is in your heart, neither can we tell what are your intentions.” Then Joseph Smith prophetically said, “Very true, gentlemen, you cannot see what is in my heart, and you are therefore unable to judge me or my intentions; but I can see what is in your hearts, and I will tell you what I see. I can see that you thirst for blood, and nothing but my blood will satisfy you.”<sup>27</sup>

At 3:48 P.M. Joseph and Hyrum Smith appeared before Robert F. Smith, who served as a justice of the peace and captain of the Carthage Greys. By 5:00 P.M. it was evident that the magistrate intended to imprison the brothers for want of bail, set at \$500 for each

---

<sup>25</sup>Roberts, *Comprehensive History*, 2:258. He adds, “Governor Ford represents in his *History of Illinois* [p. 338], that these men were placed in prison to protect them from the rabble, but says not a word about the protest of the prisoners against being thrust into jail, or the illegal means employed in putting them there.”

<sup>26</sup>Stiles, *Recollections and Sketches*, 269.

<sup>27</sup>Roberts, *Comprehensive History*, 2:256; see also Mike Trapp, “Benjamin Mayberry Prentiss, Lieutenant of the Quincy Mounted Riflemen,” in *A City of Refuge: Quincy, Illinois*, edited by Susan Easton Black and Richard E. Bennett (Salt Lake City: Millennial Press, 2000), 249–60.

defendant. But the necessary sum was raised, and the Smiths returned to their quarters. By 8:00 P.M. they had spoken with Thomas Ford and were eating supper in the dining area.<sup>28</sup>

Only a few minutes later, Constable David Bettisworth was demanding that the Smiths be incarcerated in the jail at the northeast corner of town. Believing his demand illegal, Joseph sent for Esquire Woods. "This was the state of affairs when Smith sent for me," Woods wrote.<sup>29</sup> He informed Bettisworth that the accused were entitled to see the mittimus, which Bettisworth produced.<sup>30</sup> The Smiths remonstrated but to no avail.<sup>31</sup>

A militia leader, Captain James A. Dunn, with some twenty men under his command guarded the prisoners as they walked from the hotel to the jail. A more formidable guard was a quartet of the Prophet's friends (Willard Richards, John Taylor, W. W. Phelps, and James Woods), who surrounded him and, with their walking sticks, staved off members of the hostile crowd who "several times broke through the guard" as they moved toward the jail.<sup>32</sup>

From June 25 to the afternoon of June 27, the Hamilton House was abuzz with whispered rumors and spoken threats against the prisoners. John W. Williams, an elderly Carthage farmer, overheard a thinly veiled plot of murder. "On the morning when the Smiths were killed," he testified "that he had seen [Thomas] Sharp in company with Governor Ford at Hamilton's just after breakfast and before the

---

<sup>28</sup>*History of the Church*, 6:569. The total bond of \$7,500 was raised by "Joseph Smith, Hyrum Smith, John Taylor, William W. Phelps, John P. Greene, Stephen C. Perry, Dimick B. Huntington, Jonathan Dunham, Stephen Markham, Jonathan H. Holmes, Jesse P. Harmon, John Lytle, Joseph W. Coolidge, David Harvey Redfield, and Levi Richards with John S. Fullmer, Edward Hunter, Dan Jones, John Benbow, and other unexceptionable sureties." *Ibid.*, 6:568.

<sup>29</sup>Stiles, *Recollections and Sketches*, 268.

<sup>30</sup>Roberts, *Comprehensive History*, 2:257-58. A mittimus is a precept in writing under the hand and seal of a justice of the peace or other competent officer directed to a jailer commanding him to receive and safely keep a person charged with an offense until he is delivered by due process.

<sup>31</sup>Stephen Markham, Letter to Wilford Woodruff, June 20, 1856, Fort Supply, 3, Archives of the Family and Church History Department, Church of Jesus Christ of Latter-day Saints, Salt Lake City.

<sup>32</sup>Roberts, *Comprehensive History*, 2:259.



*William R. Hamilton, a son of Artois and Atta Hamilton, was a member of the Carthage Greys, and a member of the Independent Order of Odd Fellows. This photo identifies him as the "Past Grand Master of Hancock Lodge No. 20 of the Ancient Free and Accepted Masons." Kathryn Burkett and Donald Parker, Hancock County, Illinois: A Pictorial History (Virginia Beach, Va.: Donning Company, 2000).*

governor's council with the militia."<sup>33</sup> A Dr. Southwick from Texas likewise reported, "There was a council held in Hamilton's Tavern. . . . The purport of said meeting was to take into consideration the best way to stop Joseph and Hyrum Smith's career. . . . The Governor and Capt. [Robert] Smith of the Carthage Greys was in the meeting."<sup>34</sup> Alfred Randall testified that he saw Governor Ford standing by the fence side, and heard a soldier tell the governor, "The soldiers are determined to see Joe Smith dead before they leave here." Ford replied, "If you know of any such thing keep it to yourself."<sup>35</sup>

What were Hamilton's sentiments at this time? Stephen Markham, a Mormon, left a portrait of him as anguished but helpless: "Hamilton, the Inn keeper, came out and said, 'You can do the prisoners no good and I will bring you your horse. . . .' He cried and brought my horse up."<sup>36</sup>

#### THE MARTYRDOM

About 4:00 P.M. the youngest member of the Carthage Greys, fifteen-year-old William R. Hamilton, from his perch on the courthouse roof saw men approaching Carthage from the west. In an account written December 24, 1902, he tells how he scurried down from his lookout post to inform Captain Smith. "Tell no one," Smith told young William, but let him "know should these men head directly towards the jail."<sup>37</sup> The men, "grotesquely disguised by blackened faces," went to the jail, reported William. "While there were guards

---

<sup>33</sup>Charles J. Scofield, ed., *History of Hancock County*, in *Historical Encyclopedia of Illinois and History of Hancock County*, edited by Newton Bateman, J. Seymour Currey, and Paul Selby (Chicago: Munsell, 1921), 2:1059, quoted in Hill and Oaks, *Carthage Conspiracy*, 169.

<sup>34</sup>Markham, Letter to Wilford Woodruff, 3-4.

<sup>35</sup>*History of the Church*, 6:586; See also Robert Bruce Flanders, *Nauvoo, Kingdom on the Mississippi* (Urbana: University of Illinois Press, 1965), 309.

<sup>36</sup>Markham, Letter to Woodruff, 5.

<sup>37</sup>William Hamilton, Letter to Foster Walker, December 24, 1902, printed in Foster Walker, "The Mormons in Hancock County," *Dallas City (Ill.) Review*, January 29, 1903, 2, Illinois State Historical Library, Springfield, quoted in Hallwas and Launius, *Cultures in Conflict*, 228. Hamilton was then living in Pontoosuc, Hancock County, and Walker was seeking recollections from "non-Mormons on this subject near the turn of the century." Hamilton's letter is reprinted in Foster Walker, "The Mormons in



around the jail, they were guards that did not guard and in fact I think understood the whole matter.”<sup>38</sup>

The guards let the mob rush up the stairs, and shoot into the east bedroom. Despite initial attempts to protect themselves from mob violence, the four men in the bedroom—Joseph and Hyrum Smith, Willard Richards, and John Taylor—were no match for the disguised mobbers. Eyewitness William Hamilton penned, “After I had satisfied my curiosity, seen and been among the mob, seen the prophet shot, and seen the dead men [Joseph and Hyrum Smith], it occurred to me I ought to go home and tell the news.” But when he was within a few blocks of the hotel, he was ordered to “about face, [and] return to camp” near the town center.<sup>39</sup>

Willard Richards, who was uninjured, had dragged John Taylor, who had been shot four times but was not fatally injured, into an adjoining cell and concealed him beneath a straw mattress. He was still there as the shadows lengthened toward evening. Dr. Thomas Barnes of Carthage and others wanted John Taylor to “consent to be removed to Hamilton’s hotel, where he could be cared for.” In pain and emotional shock from the deaths of his leaders, Elder Taylor hotly replied, “I don’t know you. Who am I among? I am surrounded by assassins and murderers; witness your deeds! Don’t talk to me of kindness and comfort; look at your murdered victims! Look at me! I want none of your counsel nor comfort. There may be some safety here; I can be assured of none anywhere.”<sup>40</sup>

Although the local doctor and others protested that he was safe

Hancock County,” *Dallas City (Ill.) Review*, January 29, 1903, 2, Illinois State Historical Library, Springfield, quoted in Hallwas and Launius, *Cultures in Conflict*, 228.

<sup>38</sup>Orville F. Berry, “The Mormon Settlement in Illinois,” *Transactions of the Illinois State Historical Society* (1906), 88–89, quoted in Hill and Oaks, *Carthage Conspiracy*, 20.

<sup>39</sup>William Hamilton concluded his letter to Walker, “This is a true statement of what occurred on that day, so far as the doings of the troops and killing of the Smiths. There are many facts and names of persons connected with that tragedy, which are now lost to the world—where it seems best to let them remain.” In Hallwas and Launius, *Cultures in Conflict*, 230–31.

<sup>40</sup>Roberts, *Life of John Taylor*, 143. Roberts’s quotation does not explain whether Taylor told him this account or gave him a written statement,

and “swore by all the oaths known to the damned that they would stand by him to the death,” as Roberts put it, within the hour they had fled from the city, like other citizens, fearing a reprisal attack from Nauvoo. It was only Willard Richards’s assurances that the Hamilton House would be a safe haven that convinced John Taylor to allow him to leave the jail. He later wrote, “I felt that he [Richards] was the only friend, the only person, that I could rely upon in that town.”<sup>41</sup> In turn, Willard Richards promised the Hamiltons that no harm would come to them if Taylor were in their home, while Alexander Williams proposes that Taylor might be held hostage in case of hostilities. However, I believe that Artois and Atta Hamilton may be credited with more charitable reasons for remaining in Carthage.<sup>42</sup>

John Taylor, who had no reason to trust anyone in Carthage, later wrote suspicions of the Hamiltons that became part of the Church’s official record: “I believe they were hostile to the Mormons and were glad that the murder had taken place, though they did not actually participate in it; and, feeling that I should be a protection to them they stayed. I lay from about 5 o’clock until two next morning without having my wounds dressed as there was scarcely any help of any kind in Carthage, and Brother Richards was busy with the dead bodies, preparing them for removal.”<sup>43</sup>

Richards had other duties, too. He attended the coroner’s inquest over Joseph and Hyrum Smith, held in the evening of the 27th at the Carthage Jail. Some indication of the jury’s composition and impartiality may be indicated by the fact that Robert Smith, captain of the Carthage Greys, was among their number. It ended with the unsurprising verdict that the Smith brothers had been shot by persons unknown. William R. Hamilton knew differently: “The murders were committed ‘by a respectable set of men.’”<sup>44</sup> Now Richards needed to

---

nor when he made it.

<sup>41</sup>Ibid.

<sup>42</sup>See Samuel W. Taylor, *Nightfall at Nauvoo* (New York: Avon Books, 1971), 288; see also Roberts, *Life of John Taylor*, 147.

<sup>43</sup>Roberts, *Comprehensive History*, 7:111; see also *History of the Church*, 6:625.

<sup>44</sup>Berry, “The Mormon Settlement in Illinois,” 97, quoted in Hill and

take care of the bloody and stiffening corpses.<sup>45</sup> Nauvoo, twenty-three miles away, was a journey that usually took about two hours by horseback and about six hours by wagon. Obviously it was too late to start that night. Once again, Richards looked to Artois Hamilton for help.

Hamilton drove a team and wagon to the jail, where he helped bring down Hyrum's body from the second story and lift Joseph's from the well-curbing outside. William Hamilton concurs: "The bodies of the Smiths, after the coroner's inquest, were taken by my father, Artois Hamilton, to his hotel."<sup>46</sup>

At the hotel that evening, Hamilton hammered together rough pine coffins for the bodies,<sup>47</sup> while Richards and Taylor consulted about the wording of the announcement that must be sent to Nauvoo. Willard Richards wrote the short document while John Taylor, despite his pain, added a postscript in his own hand:

Carthage Jail,  
8 o'clock 5 min P.M. June 27.

Joseph and Hyrum are dead. Taylor wounded, not badly. I am well. Our guard was forced as we believe, by a band of Missourians from 100 to 200. The job was done in an instant, and the party fled towards Nauvoo instantly. This is as I believe it. The citizens here are afraid of the "Mormons" attacking them; I promise them no.

W. RICHARDS.

---

Oaks, *Carthage Conspiracy*, 22.

<sup>45</sup>James Woods was apparently also at the coroner's inquest for "I received the effects from the body of Joe Smith and turned them over to his widow upon her giving me the following receipt: 'Received, Nauvoo, Ill., July 2, 1844, of James W. Woods, \$135.50 in gold and silver and the receipt for shroud, one gold finger ring, one pen and pencil case, one pen knife and case, one pair of tweezers, one silk and one leather purse, one small pocket wallet containing a note on John P. Green for \$50, and the receipt of Heber C. Kimball for a note of hand on Ellen M. Saunders for one thousand dollars, as the property of Joseph Smith (Signed) Emma Smith.'" In Stiles, *Recollections and Sketches*, 271.

<sup>46</sup>William Hamilton, Letter to Walker, quoted in Hallwas and Launius, *Cultures in Conflict*, 230.

<sup>47</sup>The hotel register is extant. There is no evidence that Hamilton was paid for constructing the pine boxes.

N.B.—The citizens promise us protection. Alarm guns have been fired.

JOHN TAYLOR.<sup>48</sup>

Willard Richard first entrusted this note to John and William Barnes. Fearing to go to Nauvoo, they carried it to Arza Adams, who finally delivered it to Nauvoo.<sup>49</sup>

#### THE NEXT DAY: JUNE 28, 1844

B. H. Roberts wrote solemnly: “The marvel of that morning was—as it has been the marvel ever since, and will be in all the generations to come—that the ‘Mormons’ at Nauvoo did not wreak vengeance upon the inhabitants of Carthage . . . for the murder of their Prophet and Patriarch.”<sup>50</sup>

No one has recorded the scene at the hotel. How much sleep did the Hamilton family receive as they tried to care for the wounded John Taylor, make the coffins, and deal with the rumors of a feared counter-attack from Nauvoo? Samuel Smith, riding desperately from Nauvoo, made it through to Carthage that night as well, despite attempted attacks on him. Perhaps they caught a few hours of sleep before dawn; but about 8:00 A.M., “the body of Joseph was placed in one wagon and that of Hiram [sic] in father’s wagon,” wrote William.<sup>51</sup> Prairie hay, blankets, and bushes were placed atop the pine boxes to shade them from the hot summer sun. Willard Richards, Samuel Smith, James W. Woods, the three Hamiltons (Artois, Marvin, and William) “with a guard of eight soldiers detailed by General Miner R. Deming, commander of the Hancock County militia,” began the solemn journey to Nauvoo.<sup>52</sup> John Taylor stayed behind in the care of Atta Hamilton.

Moving at cortege speed, the journey took more than six hours.

---

<sup>48</sup>Roberts, *Comprehensive History*, 2:289–90; see also Taylor, *Nightfall at Nauvoo*, 288–89.

<sup>49</sup>Roberts, *A Comprehensive History of the Church*, 2:290.

<sup>50</sup>Roberts, *Comprehensive History*, 2:288.

<sup>51</sup>William Hamilton, Letter to Walker, quoted in Hallwas and Launius, *Cultures in Conflict*, 230. The owner of the second wagon has not been identified.

<sup>52</sup>Samuel Taylor, *Nightfall at Nauvoo*, 289, credits William Hamilton as stating that he and Marvin accompanied their father, but William does not mention this detail in his letter to Foster.

Willard Richards saw anxious mourners gathered about a mile east of Nauvoo. James Woods reported, "There was a great crowd to meet us formed in lines said to have been two miles long."<sup>53</sup> Between 2:30 and 3:00 P.M. the procession passed slowly up Mulholland Street where the assembled Nauvoo Legion, city council, and thousands of mourners vented their sorrow.<sup>54</sup>

"Oh, the sorrowful scene to be seen in Nauvoo that day!" Dan Jones, a Welsh convert, descriptively penned. "There has never been nor will there ever be anything like it; everyone sad along the streets, all the shops closed and every business forgotten."<sup>55</sup> The procession proceeded down Main Street to the Mansion House, where the bodies were taken into the dining room and the door closed.

#### A SYMPATHETIC OR COERCED PARTICIPANT?

The mourners fervently thanked Artois Hamilton for his kindness, use of the hotel, and especially for conveying Hyrum's body back to his people. Several came forward and offered substantial tokens of their gratitude. He declined any remuneration and returned to the hotel that same day.

John Taylor's wife, Leonora Cannon Taylor, who had heard the dreadful news during the night, and Dr. Samuel Bennett had left Nauvoo early that morning and reached the Hamilton House before Artois and his sons returned. One bullet had been extracted from John Taylor's wrist the night before with a pen knife. Now Bennett extracted a second ball, from Taylor's left thigh but felt that it would be too dangerous to extract the two remaining in Taylor's right hip and leg. Elder Taylor later recorded: "My wife, Leonora, went into an adjoining room to pray for me, that I might be sustained during the operation. While on her knees at prayer, a Mrs. Bedell, an old lady of the Methodist association, entered, and, patting Mrs. Taylor on her back with her hand, said, 'There's a good lady, pray for God to forgive your sins; pray that you may be converted, and the Lord may have mercy on your soul.' The scene was so ludicrous that Mrs. Taylor knew not whether to laugh or be angry."<sup>56</sup>

In addition to this outrageous inappropriateness, not to men-

<sup>53</sup>In Stiles, *Recollections and Sketches*, 270.

<sup>54</sup>*History of the Church*, 6:626.

<sup>55</sup>"I Shall Ever Remember My Feelings," translated from the Welsh by Ronald D. Dennis, *Church News*, June 24, 1984, 11.

<sup>56</sup>In *History of the Church*, 7:112. Samuel Bennett was a medical doc-

tion the interruption of her prayers, Leonora must have been beside herself with anxiety for her husband and continuing fears about their safety. According to John's later account, "Mrs. Taylor informed me that Mr. [Gad] Hamilton, the father of the Hamilton who kept the house, rejoiced at the murder [of Joseph and Hyrum Smith], and said in company that 'it was done up in the best possible style, and showed good generalship.'" It is not clear whether Leonora personally heard the elderly Gad Hamilton make this statement or whether it was a second-hand and possibly exaggerated statement, but John Taylor continued: "She [Leonora] farther [sic] believed that the other branches of the family sanctioned it [the murders of the Smiths]."<sup>57</sup>

After recuperating for "three or four days," as Taylor remembers, he felt strong enough to be transported to Nauvoo. By this time, Governor Ford had advised those in Carthage to disperse, then he and his party promptly fled, not considering themselves safe until they reached Augusta. Joseph and Hyrum were buried in Nauvoo on Saturday, June 29. Some of Carthage's citizens were starting to return, but some stayed away as long as a week. Although John does not complain of any kind of negligence or threat while he stayed in the shelter of the Hamiltons, it seems that the family would have been as relieved to have them out of the tense town as Leonora and John would have been to be once more among their people. Accompanied by William Marks, James Allred, a Dr. Ells, "and a number of others" who had come from Nauvoo on horseback, the Taylors left Carthage for Nauvoo, a journey that took most of the day and, despite the care of Taylor's attendants, was an agonizing ordeal. Still, despite his bodily sufferings, Taylor's dominant memory was a strong feeling of relief: "Never shall I forget the differences of feeling that I experienced between the place that I had left and the one that I had now arrived at. I had left a lot of reckless, blood-thirsty murderers, and had come to the city of the Saints, the people of the living God."<sup>58</sup>

Was Hamilton one of the "reckless, bloodthirsty murderers"? John Taylor accurately states that he was not in the mob who

---

tor, market inspector, and associate justice of the Nauvoo Municipal Court. In October 1840, he headed a branch of the Church in Cincinnati, Ohio.

<sup>57</sup>Ibid., 7:112.

<sup>58</sup>Roberts, *The Life of John Taylor*, 149.

stormed the jail. But was Hamilton sympathetic to the murderous intent and action of the mob? Leonora and John definitely thought so. Willard Richards's account contains no speculations about the Hamiltons' motives. There is circumstantial evidence that, probably in February 1846, Brigham Young gave Hamilton sixteen keys to the interior doors of the Nauvoo Temple for "safe keeping, and in appreciation for the tender care Mr. Hamilton gave the bodies of Joseph and Hyrum Smith."<sup>59</sup>

During the Battle of Nauvoo in September 1846, a six-pound iron cannon that had once belonged to an artillery company in Carthage found itself ownerless. When Hamilton heard that "Jo [sic] Backenstos, a 'Jack Mormon' leader, was coming to take away the cannon, [he] unlimbered the gun and hid it in a cornfield." The anonymous author of this 1894 local history suggests that, by hiding the cannon, Hamilton hoped to prevent further atrocities against the Mormons, but it is also possible that Hamilton did not want the weapon to fall into Mormon hands.<sup>60</sup>

---

<sup>59</sup>Phil Germann, Historical Society of Quincy and Adams County, quoted in Carrie A. Moore, "Museum in Illinois Town Has a Set of 16 Keys to First Nauvoo Temple," *Deseret News*, June 26, 2002. Peter Shirts, an LDS resident of Nauvoo, is believed to have made the Nauvoo Temple keys. Germann explained: "It's interesting to speculate why they were given to Hamilton. I think it was possible that Brigham Young thought they would be coming back, but we don't know." The keys are inscribed: "Keys to the Old Mormon Temple." These keys were presented to the Historical Society of Quincy and Adams County in the 1940s by E. Bentley Hamilton and Mrs. Allan F. Ayers, grandchildren of Artois Hamilton. "They have been housed there ever since," said Germann. Glen Leonard, director of the Museum of Church History and Art, was unable to "verify whether they were actually keys to the temple."

<sup>60</sup>The cannon remained in the cornfield until the state forces arrived and Hamilton gave it to them. *Portrait and Biographical Record of Hancock, McDonough and Henderson Counties, Illinois, Containing Biographical Sketches of Prominent and Representative Citizens of the County, Together with Biographies and Portraits of All the Presidents of the United States* (Chicago: Lake City Publishing Co., 1894), 258. "Jo Backenstos" was actually Jacob B. Backenstos, born in 1811 in Dauphin County, Pennsylvania. His only brother, William, married Emma Smith's niece, Clara M. Wasson, on October 3, 1843. Jacob,

## THE REST OF THE STORY

By the winter of 1846-47, Nauvoo's Mormon population consisted only of a handful of people, like Emma Smith and her sons, who had decided not to follow Brigham Young west. The vivid and painful Mormon period of Hancock County's history was already receding into the past. The 1850 census reveals that Hamilton, now age fifty-four, was still keeping his hotel in Carthage, although he was also busily engaged in improving five or six quarter sections in the vicinity of the hotel. The *History of Hancock County* explains that "close attention to his accumulating interests and prudent management soon made Mr. Hamilton the wealthiest man in the county."<sup>61</sup> Still living with their parents were twenty-one-year-old Marvin, twenty-year-old William, eighteen-year-old Amelia Ann, seventeen-year-old John D., fourteen-year-old Mary B., and eleven-year-old Elisha B.<sup>62</sup>

This picture of prosperity and family cohesiveness changed drastically within a year. In July 1851, a great calamity—cholera—befell the Hamilton household. Some say the scourge came with a "Circus and Menagerie" that exhibited in Carthage on Monday, July 14, 1851, most of whom lodged at the Hamilton House. Others point to land sales being held at the county courthouse that same day. Buyers and sellers from Quincy, Peoria, and surrounding towns were also staying at the hotel.<sup>63</sup>

Either or both could have provided the vector of the disease, but the first victim, on July 16, was Amelia Ann. When Dr. D. M. Geiger, John Mack, Thomas L. Barns, and George W. Hall were summoned to her bedside, they "agreed without hesitation that the disease was the severest form of Asiatic cholera" but could do nothing to help.

---

a staunch Democrat, was appointed clerk of the Hancock County court in 1841 by Stephen A. Douglas and became sheriff of Hancock County in 1844. He was never a Mormon, but he tried strenuously to defend Mormon rights as the county descended into social chaos after the assassinations. Omer (Greg) W. Whitman and James L. Varner, "Sheriff Jacob B. Backenstos," *Journal of Mormon History* 29, no. 1 (Spring 2003): 150-78.

<sup>61</sup>Gregg, *History of Hancock County*, 715.

<sup>62</sup>Patricia Jewell Ballowe, Violet Michaelis Jewell, and Carol Watkins Lundgren, *1850 Census of Illinois: Hancock County* (Richland, Wash.: Locust Grove Press, 1977), 5.

<sup>63</sup>"A Reminiscence: The Cholera Epidemic in Carthage in July 1851," *Carthage Republican*, September 11, 1938, 3.



Customers still at the hotel immediately scattered to other lodgings. None save the sick and their attendants remained while five died in the Hamilton family. Cholera was a speedy killer. Another woman, Miss Orinda Chapin, died the same day as Amelia. Atta followed two days later on the 18th. Marvin succumbed on the 19th, and Artois's sister, the unmarried Lavina, died on the 23rd.<sup>64</sup> Artois contracted the disease but survived.

Although the scourge sparked panic in Carthage's inhabitants, it "had done its worst in the Hamilton household, and seemed content to cease there."<sup>65</sup> These multiple deaths, according to local accounts, changed forever his cheery demeanor.<sup>66</sup>

A year after the cholera epidemic, he sold the Hamilton House to C. S. Hamilton, a relative, though the exact relationship is not known. Artois then married a widow, Susan Smith, and built a second hotel, also named the Hamilton House, on the north side of the street.<sup>67</sup> The 1886 photograph that so often is used to illustrate the Hamilton House is of the second hotel, which lodged such prominent men as Abraham Lincoln, Stephen A. Douglas, Orville H. Browning, and Governor Thomas Ford. It is not now known how long Artois owned this second hotel. It functioned "under various names and by several proprietors until 1913."<sup>68</sup>

Four years later, Artois laid out and named the nearby town of Hamilton, Hancock County, Illinois, but never took up residence there.<sup>69</sup> By 1860, he was sixty-five years old and retired from public life. "It was said by some," noted a local historian, "that Mr. Hamilton never had but one hobby in his life, and that was the celebration of

<sup>64</sup>Ibid.

<sup>65</sup>Ibid.

<sup>66</sup>Ibid.

<sup>67</sup>Susan survived him and died in Carthage August 24, 1880. *Portrait and Biographical Records*, 258.

<sup>68</sup>*Historic Sites and Structures of Hancock County, Illinois* (Hancock County, Ill.: Historic Sites Committee, Hancock County Historical Society and the Hancock County Bicentennial Commission with the support of the Hancock County Board, 1979), 68.

<sup>69</sup>The town of Hamilton is located at "the end of Lock and Dam No. 19. . . . The first settler of the township was I. J. Waggoner, who also is believed to have been the first settler of Hancock County." Drury, *This Is Hancock County, Illinois*, 283. The town still exists and had an estimated popula-



*Hamilton, Illinois, the town Artois Hamilton laid out in 1856. John Drury, This Is Hancock County, Illinois (Chicago: Loree Company, 1955), 283.*

July 4.” He believed that this day should be “observed and honored in the ceremonies appropriate to its patriotic inspirations.”<sup>70</sup> For decades he was the leader of the Fourth of July celebrations in Carthage and spent the needed time and money to assure its success.

His most memorable July 4 celebration was 1873 when he was within a month of his seventy-eighth birthday. As usual, he arranged the program that included a military display and mock battle with three hundred boys wearing military hats and carrying wooden guns, whom he called the “Army of the Revolution.” After the program that year, the boys marched to his residence to stack their wooden arms. “Boys, you have done nobly today; you have acted like patriots and gentlemen, and I am proud of you,” said Hamilton. “This is the last Fourth of July I will ever celebrate, boys, and I want you to remember this. Mind your parents, and remember the Fourth of July, and you will make good men and be an honor to the country.”<sup>71</sup>

He then sat down on his porch, conversed with the relatives and

---

tion of 2,895 in 2003.

<sup>70</sup>*Portrait and Biographical Record*, 259.

<sup>71</sup>*Ibid.*

friends who were there for a few moments, then, mentioning that he felt sick, he went into his house and lay down. Then he closed his eyes and passed away. Family members believed that if he had “been permitted to select the hour of his death he would not have wished it different.”<sup>72</sup>

Four children survived him. William Ransom Hamilton was elected sheriff of Carthage on the Democratic ticket in 1858 and served a two-year term.<sup>73</sup> He then retired to his farm, where he successfully managed agricultural pursuits for more than two decades. In 1882 William sold the farm and made his way to the Pacific Northwest. After a few months, however, he returned to Hancock County and purchased a home in Carthage. William served as a judge in the community for ten years (1883–93) and as postmaster for four (1893–97).<sup>74</sup> He died in 1907 in Carthage.

His younger brother John D. served as a sergeant major in the 16th Illinois Infantry Volunteers in the Civil War and later as a clerk in the Illinois penitentiary located in Chester. He died on August 13, 1892, in Chester.<sup>75</sup>

Elisha Bentley Hamilton, the youngest child of Artois and Atta, graduated from Illinois College at Jacksonville, enlisted as a private in the 188th Infantry Volunteers during the Civil War, and was promoted, first to the rank of quartermaster sergeant and then to first lieutenant. After the war, he became a lawyer in Quincy, Adams County, Illinois. He served as an inspector general of the Illinois National Guard and as a member of the governor’s staff.<sup>76</sup> He died in 1902 in Quincy.

Little is known of the only surviving daughter Mary B. She may not have married and was living with Elisha in Quincy when she died in 1915.

### CONCLUSION

Was Hamilton a good man in Carthage? Many facts relevant to

---

<sup>72</sup>Ibid.

<sup>73</sup>“Kathryn Burkett and Donald Parker, *Hancock County Illinois, A Pictorial History* (Virginia Beach, Va.: Donning Company Publishers, 2000), 70.

<sup>74</sup>*Biographical Review of Hancock County, Illinois*, 683.

<sup>75</sup>*Portrait and Biographical Record*, 259.

<sup>76</sup>*History of Hancock County*, 717.

this conclusion have been presented. On the negative side are the testimonies of John and Leonora Taylor. On the positive are Hamilton's actions in sheltering the injured Taylor, retrieving and coffining the bodies, and helping to transport them to Nauvoo. Did Hamilton see Taylor's presence as some kind of safety guarantee for his own family or was he motivated by charity?

Similarly, were his respectful actions toward the assassinated Smith brothers a sign of compassion or were they motivated by the desire to remove the bodies from Carthage as quickly as possible? Were the tears he shed as he brought Stephen Markham his horse motivated by sorrow at the inevitability of the tragedy he could see unfolding or by terror of the possible consequences? Can a fair decision be reached by pitting the opinion of a wounded apostle and his grief-stricken and frightened wife against the documented actions of the hotel proprietor? Did he have sympathy for the fallen Mormon leaders or was he coerced into displaying a charitable demeanor?

The final decision, for or against the goodness of Artois Hamilton, a minor player in the tragedy that unfolded in Carthage on July 27, 1844, awaits either additional research findings or a persuasive re-interpretation of the available evidence.



*The distinctive turtle-shaped dome of the Mormon Tabernacle is visible behind the Salt Lake Temple in this overhead view looking west. Photo taken October 22, 1998, by Nathan D. Grow.*

# ONE MASTERPIECE, FOUR MASTERS: RECONSIDERING THE AUTHORSHIP OF THE SALT LAKE TABERNACLE

*Nathan D. Grow*

THE MORMON TABERNACLE ON TEMPLE SQUARE in Salt Lake City is a masterpiece without a master. Since the time it was first used for services of the Church of Jesus Christ of Latter-day Saints in October 1867, the Tabernacle has been praised by artists, architects, musicians, engineers and countless other visitors. This praise has not been universal,<sup>1</sup> but critical opinion seems to have settled more on the side of Frank Lloyd Wright, the twentieth-century American icon of architecture, who called it “one of the architectural masterpieces of the country and perhaps the world.”<sup>2</sup> From October 1867 until April 2000 when the Conference Center was inaugurated, the semi-annual April and October general conferences were held in this remarkable building. Now

---

NATHAN D. GROW {ndg2101@columbia.edu} is currently in his third year at Columbia University School of Law. He wrote this paper as an undergraduate at Brigham Young University for Eric Dursteler’s History 490 class. He expresses appreciation to Professor Dursteler for his guidance as well as to his parents, Michael and Leslie Grow, for sharing family stories about Henry Grow, his great-great grandfather.

<sup>1</sup>One Mormon commentator called the Tabernacle “the most uncomely edifice that was ever erected for a place of worship.” T. B. H. Stenhouse, *The Rocky Mountain Saints* (New York: D. Appleton and Co., 1873), 693. See Ronald W. Walker, “The Salt Lake Tabernacle in the Nineteenth Century: A Glimpse of Early Mormonism,” this issue, for an impressive range of nineteenth-century responses to the building.

<sup>2</sup>As quoted in Richard L. Evans, Speech, *Report of the Semi-Annual Con-*

closed for retrofitting, the Tabernacle, though no longer used for general conferences, will still play a role in the social and religious life of the Saints.

Its reputation as a great building is firmly established, but the identity of its architect remains a controversy. Even before it was completed, disagreements began over who would receive credit for the building's design. The four men who are commonly associated with its design and construction are Brigham Young, William H. Folsom, Henry Grow, and Truman O. Angell. Perhaps if these four had agreed on who was to be called the architect, it would not be such a mystery today.

On the back of Henry Grow's business card is the statement that he was the architect who planned the Tabernacle.<sup>3</sup> William Folsom once stated that "Henry Grow . . . has . . . claimed to be the designer and architect of the [Tabernacle] but such is not the case." Instead, he was himself the "architect of the Tabernacle and drew the plans for the same."<sup>4</sup> There is no record that Truman Angell ever called himself the Tabernacle architect, but Church Architect Joseph Don Carlos Young wrote, "Inasmuch as there has been some misapprehension in regard to who was the architect for the large Tabernacle in Salt Lake City, I desire to emphatically state that Truman O. Angell, Sr., was the designer and made the drawings for this building."<sup>5</sup> Both Grow and Folsom acknowledged that Brigham Young had given them the idea for the general design of the building. But according to one of Young's daughters, if Young were asked to identify the architect of the Tabernacle, he would reply: "God is the Supreme Architect. We owe all our inspiration, our love of beauty and the knowledge of how

---

*ference of the Church of Jesus Christ of Latter-day Saints*, (Salt Lake City: Church of Jesus Christ of Latter-day Saints, semi-annual), October 1967, 63.

<sup>3</sup>Henry Grow, "Business Card," Archives of the Family and Church History Department, Church of Jesus Christ of Latter-day Saints, Salt Lake City (hereafter LDS Church Archives).

<sup>4</sup>The holograph of William Folsom's statement is in the Bancroft Collection, University of California, Berkeley; quoted in Nina Folsom Moss, *A History of William Harrison Folsom* (Salt Lake City: William Harrison Folsom Family Organization, 1973), 45.

<sup>5</sup>Joseph Don Carlos Young, "Statement, November 12, 1934," 1, LDS Church Archives.

to express our views to the Father in Heaven.”<sup>6</sup>

These contradictory statements and others about the authorship of the Tabernacle have fueled a minor but long-lasting debate. Approximately two dozen combinations or variations of contributions have been used to associate these four men with the design and construction.<sup>7</sup> This article reviews the historical sources and concludes that all four men made essential contributions to the building’s design and construction.<sup>8</sup> All four were “architects” of the building, and all four should receive credit for contributing to its significance.

### DEFINITIONS OF AN ARCHITECT

Part of the difficulty in identifying the building’s architect, in addition to confusion among the sources, is the wide range of definitions of “architect” used by the various writers. The current Merriam-Webster’s Online Collegiate Dictionary defines *architect* as “a person who designs buildings and advises in their construction.” A contemporary architectural dictionary defines an architect as a “person capable of preparing the plans, elevations, and sections of the design of a sophisticated building with an aesthetic content and to supervise its construction in accordance with the drawings and specifications.”<sup>9</sup> However, since technology has dramatically changed architecture since the 1860s, it seems possible that the definition of *architect* might have also changed. But Webster’s 1861 dictionary gives basically the same definition: “A person skilled in the art of building; one who understands architecture, or makes it his occupation to form plans and designs of buildings, and superintend

---

<sup>6</sup>Susa Young Gates, *The Life Story of Brigham Young* (New York: Macmillan, 1930), 229.

<sup>7</sup>See Appendix. A few of these sources, written by descendants of the four men, manifest considerable bias in favor of their ancestors. Despite my inevitable partiality for my own ancestor, I have made every effort to approach this study without biasing my conclusion toward him.

<sup>8</sup>Kate Carter, *The Great Mormon Tabernacle* (Salt Lake City: Daughters of the Utah Pioneers, 1967), 7, also concluded that all four men should share equally in the credit for the Tabernacle. This article supports and elaborates on Carter’s conclusion.

<sup>9</sup>James Stevens Curl, *Dictionary of Architecture* (Oxford, Eng.: Oxford University Press, 1999), 32.



the artificers employed.”<sup>10</sup>

Though the dictionary definition has changed little, the job description has undergone significant alterations. In the nineteenth century, an architect commonly supervised and participated actively in the construction, while a contemporary architect, after drawing up the plans, frequently turns the project over to contractors. Another difference is that engineers may now be in charge of drawing plans for large portions of a building that must meet technical and structural demands while, in the 1860s, *engineer* often had a military meaning as “a person skilled in mathematics and mechanics, who forms plans of works for offense or defense, and marks out the ground for fortifications.”<sup>11</sup> The term also described civil engineers who built “public works, [such] as aqueducts and canals,” but it was not used to describe people who worked primarily on buildings.

An architect’s job, both now and then, essentially consisted of two tasks: design and supervision. But earlier definitions of *architect* had a broader application to those who contributed to a building’s creation. A 1902 architectural dictionary suggests the term’s flexibility:

Obviously, an architect may be charged with any part of this work, and may leave it to another at any state of the proceedings. The man is equally an architect who, having undertaken the task of carrying the whole building to a conclusion, dies after the lot is chosen, the drawings made, and the main lines are staked out upon the ground. Equally is he an architect who, taking charge of a building nearly finished, carries it to completion, including its decorations and final preparation for use. The term signifies nothing more than head workman or director of the workmen, and the exact duties of the architect vary with the epoch, the country, the kind of building, and the wishes of the owner.<sup>12</sup>

As this quotation implies, a given building may have more than one architect. The term can be applied to anyone who at any time has

---

<sup>10</sup>Noah Webster, *An American Dictionary of the English Language* (Springfield, Mass.: George and Charles Merriam, 1861), s.v., “architect.”

<sup>11</sup>*Ibid.*, s.v., “engineer.”

<sup>12</sup>Russell Sturgis, *A Dictionary of Architecture and Building*, 2 vols. (1902; reprinted, Detroit, Mich.: Gale Research Company, 1966), 1:122.

control over design or construction.<sup>13</sup>

To examine the question of who the Tabernacle's architect was, then, it is logical to ask who had control over the design and construction. But since this responsibility changed hands, to varying degrees, it is perhaps more historically significant to determine who contributed to the construction and how. This paper recounts the history of the building's construction chronologically, highlighting the significant yet different contributions that Brigham Young, William Folsom, Henry Grow, and Truman Angell each made to the design and construction at different times.

### BRIGHAM YOUNG AND THE TABERNACLE PLANS

Since Brigham Young saw the need for such a building, conceived its basic shape, and mobilized Church resources to cause its construction, he obviously played an essential role in the Tabernacle's construction. His situation also highlights the fact that receiving appropriate credit for the Tabernacle is not necessarily the equivalent of being the building's architect.<sup>14</sup>

Although he probably built very few buildings himself, Young was a carpenter and was involved in the planning of many important structures including the LDS temples in Nauvoo, St. George, Manti, Logan, and Salt Lake City. He took an active interest in the construction of numerous tabernacles besides that in Salt Lake City and certainly involved himself in the domestic architecture of his own two homes, the Lion House and the Beehive House, still important landmarks in downtown Salt Lake City. Young married Truman O. Angell's sister, Mary Ann, in 1834 and years later, married as plural

---

<sup>13</sup>This portion draws heavily on my interviews with S. Olani Durrant, October 18, 2002; Craig Wilkenson, October 21, 2002; and Timothy Maxwell, October 31, 2002. These three men are experts in the fields of architecture and engineering and have special interest in the Tabernacle. I express my appreciation for their assistance in helping me understand the various roles of an architect.

<sup>14</sup>For biographical information on Brigham Young, see Andrew Jensen, *Latter-day Saint Biographical Encyclopedia: A Compilation of Biographical Sketches of Prominent Men and Women in the Church of Jesus Christ of Latter-day Saints*, 4 vols. (1920; reprinted, Salt Lake City: Western Epics, 1971), 1:8–10; Leonard J. Arrington, *Brigham Young: American Moses* (New York: Alfred A. Knopf, 1985); and Gates, *The Life Story of Brigham Young*.

wives, Angell's widowed mother, another sister, and Folsom's daughter.

Young had also ordered and supervised the construction of a series of four temporary boweries and the "Old Tabernacle" on Temple Square, which all failed to adequately provide for the needs of the rapidly expanding church. In the early to mid-1850s Young began to consider erecting a much bigger building, but he was limited by scarce resources. At the time, Salt Lake City was about a thousand miles from the nearest railroad track, there was little access to metal, and the closest trees were miles away. Young's decision to erect a building of the Tabernacle's size required a leap of faith for that small community in the wilderness. No one else in Utah had the power or courage to propose such a large project and see it through to completion. In sum, the Tabernacle would have been impossible without Young's leadership.

Many oral traditions persist concerning Young's inspiration for the distinctive shape of the building: an "umbrella, or turtle back, or half an egg."<sup>15</sup> One of Young's daughters reportedly said he got the idea from the small elliptical portion on the back of the old Tabernacle which resembled a band shell.<sup>16</sup> Young may have originally wanted a circular building, but through consultation with others, it was determined that an oval design would maximize the interior space.<sup>17</sup> Most important, Young decided that the building should have a freestanding roof so that every person in attendance could have an unobstructed view of the speaker. This stipulation greatly influenced the design of the building.<sup>18</sup>

With a clear idea of what kind of building he wanted, Young consulted with William Folsom and Henry Grow. These two men translated Young's vision into a workable architectural plan. Though

---

<sup>15</sup>"William H. Folsom and Salt Lake Tabernacle," unpublished typescript with photograph, n.d., LDS Church Archives.

<sup>16</sup>Preston Nibley gathered this information from Young's daughter, Susa Young Gates. Stewart L. Grow, "A Historical Study of the Construction of the Salt Lake Tabernacle" (M.A. thesis, Brigham Young University, 1947), 143.

<sup>17</sup>Vern Melvin Brown and Legrand Haslem, "Engineering Investigation of the Great Mormon Tabernacle" (B.S. thesis, University of Utah, 1940), 1.

<sup>18</sup>Durrant, interview.

Young may not have designed any of the finer details of the building, he apparently had an active role in the planning, and it seems likely that he examined and approved of their plans, as he did later for Truman Angell's interior design. Angell's journal records that he showed Young all or most of the plans and drawings he made and that Young made changes and suggestions which Angell implemented even when he may not have agreed with them.<sup>19</sup>

Furthermore, Young materially aided the construction of the Tabernacle by mobilizing the workforce. Young arranged for the Church to pay the workers in tithing script, which they could exchange at the Tithing Office for goods that Church members donated. Although the workers' wages were lower than the going rate for other jobs in the territory, many came to work on the Tabernacle in response to Young's persistent public encouragement. During one talk, Young rebuked those motivated by monetary concerns: "We want the Tabernacle finished, and when a man is asked to go and work on it, do not make a wry face, and say . . . 'I will work for the devil as quick as for the Lord Jesus Christ.' Do not say that any more. The mechanics [workmen], by their conduct have said hitherto, 'We will build up hell as quick as we will heaven, if we can get sixpence more a day for doing it.'"<sup>20</sup> Such a bold speech was successful in motivating what amounted to a substantial contribution in free labor.

Young also spent some time on the construction site supervising the work that was being done.<sup>21</sup> A newspaper report in 1867 notes: "The work from beginning to end has been closely supervised by President Young, who in this, as in everything else of public character, 'has been in all and through all' and encouraged by his confidence all engaged in it."<sup>22</sup>

### WILLIAM FOLSOM AND EARLY CONSTRUCTION

Though Young authorized the specific shape of the Tabernacle and provided the leadership, financing, and workforce to build it, he needed the help of a trained architect. No single person in Utah at the

---

<sup>19</sup>Truman O. Angell, Journal, 1867-68, September 25, 1867, LDS Church Archives.

<sup>20</sup>Brigham Young, *Deseret News*, May 29, 1867.

<sup>21</sup>Truman Angell, Journal, June 14 and July 6, 1867, confirms Young's presence on the construction site.

<sup>22</sup>*Salt Lake Telegraph*, October 6, 1867.

time had the experience and training to design something as impressive as the Tabernacle. William Folsom, “perhaps the most skilled designer of his generation in Utah,” probably came the closest.<sup>23</sup> To Folsom goes the credit of drawing the only known plans of the greater structure and supervising the beginning stages of construction.

Folsom was born in Portsmouth, New Hampshire, on March 25, 1815. In 1842, he and his family converted to the LDS Church in Buffalo, New York, and moved to Nauvoo. Having been trained to work with his hands by his father, who was a contract builder on the docks around Lake Erie, Folsom worked as a carpenter and joiner on the Nauvoo Temple. Folsom remained behind in 1846 to finish the temple and did not come to Utah until 1860. During these intervening fourteen years, he moved to Iowa, to California during the gold rush, back to Buffalo, New York, and then to Nebraska before finally rejoining the Saints. Folsom’s travels exposed him to the latest styles of public architecture in the United States and he worked on various projects, designing, for example, the pillars for the territorial capitol building in Omaha, Nebraska. Though Folsom had never been formally trained, it was these observations and experiences that made him a capable architect.<sup>24</sup>

Once in Utah, Folsom worked on such projects as the Salt Lake Theatre, the Gardo House, and the ZCMI Building. He also advised on the design of the Salt Lake Temple and the construction of the St. George Temple. However, he is best known for designing the Manti Temple.<sup>25</sup> He remained involved in architecture and construction until his death in 1901.<sup>26</sup>

Brigham Young approached Folsom and Henry Grow for help with the Tabernacle project sometime before April 1863; however, it is unclear whom Young contacted first. Folsom had replaced Angell as Church Architect in October 1861 and was overseeing all of the Church’s building projects. Under Young’s direction, Folsom drew some preliminary plans,<sup>27</sup> which were probably the only plans ever made of the greater portion of the building. At this time, the building’s footprint was set at 250 feet long and 150 feet wide.

---

<sup>23</sup>Paul L. Anderson, “William Harrison Folsom: Pioneer Architect,” *Utah Historical Quarterly* 43 (Summer 1975): 241.

<sup>24</sup>*Ibid.*, 241–44.

<sup>25</sup>*Ibid.*, 251–53.

<sup>26</sup>“Death of William Folsom,” *Deseret Evening News*, March 10, 1901.

<sup>27</sup>Many sources agree that these plans were made, but their exact

At the April 1863 general conference, convened in the Old Tabernacle on Temple Square, Daniel H. Wells, a counselor in the First Presidency and director of public works, announced the Church's plan to build the new Tabernacle. During the conference, other Church leaders, including Young, stressed the need for this building. The members of the Church were urged to give their time and energy to help build the Tabernacle. Heber C. Kimball, Young's other counselor, even invited women to "pull off your jewels, take your ornaments out of your hair, your earrings" and give them to the Church to help fund the Tabernacle.<sup>28</sup>

On April 18, 1863, Folsom accompanied Jesse W. Fox to the "temple block" (Temple Square) to survey the Tabernacle site. Digging for the foundation began soon after. On June 3, the *Deseret News* reported that the excavation was almost complete and also provided a description, signed "William Folsom: Architect," of the future building. However, discrepancies emerge between Folsom's description and the actual building. He wrote that the height from the ground to the eaves of the cornice would be 45 feet, but it actually ended up being much less. According to Folsom, the roof was supposed to be "quarter pitch" (that is, pointed with straight, slanted sides); instead it is domed. He also described a large attic and a pair of octagonal ventilators which are nowhere to be found.<sup>29</sup>

While this June 1863 description no doubt followed Folsom's plans at that point, the design was obviously altered. Almost certainly, Henry Grow influenced these changes, since the changes to the roof design reflect Grow's knowledge of lattice wood construction. Furthermore, Young must have overseen and approved the changes to the design. The fact that Folsom's original design was changed does not make him any less an "architect" of the Tabernacle. Many aspects of his design remain in the building and he personally oversaw the

---

whereabouts are no longer known. There is also no way to know how detailed these plans were or how much they were used in the construction. Nina Folsom Moss, Folsom's granddaughter, *History of William Harrison Folsom*, 45, says that the plans were left in Folsom's house when it was sold and were later burned.

<sup>28</sup>*Journal of Discourses*, 26 vols. (London: Latter-day Saints Book Depot, 1854–86), 10:10. See also, Stewart L. Grow, *A Tabernacle in the Desert* (Salt Lake City: Deseret Book Company, 1958), 32.

<sup>29</sup>Grow, "A Historical Study," 69.

construction of the foundation and the pilasters.

Only a week after its first report, on June 10 the *Deseret News* reported that the foundations of the piers were mostly in place and some of the columns were being raised.<sup>30</sup> Folsom used sandstone from quarries in Red Butte Canyon for the forty-four columns around the building's perimeter. When the columns were finished, construction slowed, then halted. The cornerstone was placed sometime in 1864, but then hardly any progress was made until September 1865.

It is difficult to identify the reasons for this hiatus, since Church leaders continued to stress the need for a tabernacle in general conferences between October 1863 and April 1865. Possibly, even as a public works project, funding was inadequate or workmen found more remunerative employment or were assigned to other Church projects. Some workers may have left, believing that the design was too ambitious.<sup>31</sup> True, Young had ordered that the pillars should be left untouched for a year so that they could settle before anything was placed on top of them. But construction on the roof could have moved forward during that year because it was constructed first on the ground and then hoisted on top of the columns.

The delay was at least partly due to a growing conflict between the architects. Folsom supervised the initial stages of construction; but when work recommenced in September 1865, Grow was supervising the construction of the roof and perhaps construction in general. Young apparently replaced Folsom with Grow as construction supervisor.

There are many indications that Folsom fell out of favor with the other three architects at some point during the construction. Years after the construction, two of Grow's children claimed that Folsom became jealous when Young appointed Grow to superintend the work. Grow's daughter Nellie said that Folsom "spent much time watching the work and brought others to watch. To these people he would remark that 'when the supports are taken out the whole thing will collapse.'" According to this family story, Grow became so frustrated with this interference he involved Brigham Young, who told Folsom to stay away from the project.<sup>32</sup> However, Folsom's obituary read that "while others scouted the idea of the [Tabernacle] Folsom had faith in it," a view that does not support the Grow family's account of him as a

---

<sup>30</sup>*Deseret News*, June 10, 1863.

<sup>31</sup>Moss, *A History of William Harrison Folsom*, 75.

<sup>32</sup>Nellie Grow Forman, Midvale, Utah, Letter to John H. Taylor, Salt

doubter.<sup>33</sup>

In April 1867, Angell was again appointed Church Architect, but Folsom was retained as an assistant. Angell's biographer points out that Angell had initially resigned in 1861 because of illness but also because he was so frustrated with the job.<sup>34</sup> Folsom may have asked to be released as Church Architect for these same reasons. In addition to working as the Church Architect, he was serving on the Salt Lake High Council and co-partnering his own business. However, if he were really banished from the construction site (a point on which no independent corroboration has yet been found), then that may have prompted his release.

In any case, Folsom likely had little influence on the Tabernacle's construction after September 1865 and certainly nothing to do with the building after April 1867. Various entries in Angell's journal suggest that Folsom was elsewhere working on other projects through the spring and summer of 1867.<sup>35</sup> Angell indicated that, even though he felt overburdened, he did not want Folsom's help: "[H]e has his stile of work and I have mine. And I am shure mine would be rite for I make all the envestagions that come in the way and that is more then I know of his work for this reason I seek my way alone," he wrote.<sup>36</sup> Furthermore, instead of helping, Folsom was drawing away some of the best joiners (or carpenters) to work for him on other projects.<sup>37</sup>

Since Folsom was not part of the later stages of construction, some have argued that he should not be considered an architect.<sup>38</sup> But according to the definitions given earlier, an architect need not be involved in every aspect and stage of construction. Folsom was indeed an architect of the Tabernacle because he had a great impact on the design and supervised the beginning stages of construction. The

---

Lake City, May 27, 1943, typescript, LDS Church Archives.

<sup>33</sup>"Death of William Folsom," *Deseret Evening News*, March 10, 1901.

<sup>34</sup>Paul L. Anderson, "Truman O. Angell: Architect and Saint," in *Supporting Saints: Life Stories of Nineteenth-Century Mormons*, edited by Donald Q. Cannon and David J. Whittaker (Provo, Utah: Brigham Young University, Religious Studies Center, 1985), 160.

<sup>35</sup>Angell, Journal, May 3, 6, and 10, 1867.

<sup>36</sup>*Ibid.*, July 15, 1867.

<sup>37</sup>*Ibid.*, July 8, 1867.

<sup>38</sup>See, for example, Grow, *A Historical Study*, 148; and Anderson, "William Harrison Folsom," 248.



Tabernacle might not have ever been built if he had not helped the project get off the ground.

### HENRY GROW AND THE TABERNACLE ROOF

Folsom was the best equipped to draw the plans of the Tabernacle, but the huge, freestanding roof required special skills. After Young conceived the idea for the Tabernacle, he apparently consulted with bridge builder Henry Grow, hoping that Grow could build a large self-supporting wooden roof over the Tabernacle using bridge designs and techniques.<sup>39</sup> Grow's contribution to the Tabernacle was designing the roof and supervising construction from September 1865 until its completion in October 1867.

Grow was born on October 1, 1817, in Philadelphia and trained to build mills and bridges. By age twenty-five, he was the "superintendent of culverts and bridges on the Norristown and Germantown railroads."<sup>40</sup> In 1842, he became a Mormon and moved to Nauvoo, arriving at about the same time as Folsom. Like Folsom, he worked on finishing the Nauvoo Temple and stayed behind after the majority of Church members had left Illinois.

In 1851 Grow and his family crossed the plains to Utah and settled in Mound Fort, north of Ogden. When Young heard of Grow's experience in building bridges and mills, he called him to Salt Lake City and put him to work on various projects. Grow built a series of four sawmills in Big Cottonwood Canyon that were later used to saw wood for the Tabernacle. He also built bridges over the Weber and Jordan Rivers using the Remington patent of lattice woodwork. The owner of the patent had given Grow permission to use it in Utah.<sup>41</sup> Though he worked on a few large buildings, such as the Salt Lake Theatre that Folsom had designed, Grow had very little experience designing buildings, let alone one as large and complex as the Tabernacle. Later in his life, he was made superintendent of all the buildings and carpentry work for the Church and contributed to the construction of

---

<sup>39</sup>Forman, Letter to John H. Taylor, May 27, 1943.

<sup>40</sup>Preston Nibley, *Statuarts of Mormonism* (Salt Lake City: Deseret Book, 1954), 39.

<sup>41</sup>Clarissa Young Spencer, *Brigham Young at Home* (Salt Lake City: Deseret Book, 1961), 271.

the Salt Lake Temple.<sup>42</sup> He died in 1891.

Young consulted with Grow about the Tabernacle at about the same time he involved Folsom (before April 1863), but there is no way to know whom he consulted first. Young apparently made the decision to use the Remington patent to construct the roof. Since Grow was the only person in Utah who had the knowledge and the right to use the patent, his contribution became very important.

The roof was the major element of the construction. Over one million board-feet of lumber for the roof alone had to be cut and hauled down from the canyons to the construction site. Huge timbers were steamed and weighted on each end to make them curve to the desired angle. Since there was a scarcity of nails, wooden pegs were used to fasten the timbers together. The pegs were then split with wedges perpendicular to the grain of the timbers to make them more secure. Wherever the wood began to split, it was wrapped with rawhide which contracted as it dried. Over the years, the pegs and the rawhide have held, and very little work has been needed to keep the roof in good repair.<sup>43</sup>

At the highest point, the ceiling is sixty-eight feet above the floor with an interior space of nine feet between the ceiling and the roof. Nine large lattice arches span the width of the building. In bridge-building, Grow only had to construct two of these lattice arches, then connect them; but the Tabernacle roof was more complex and required greater creativity than any bridge Grow had ever built. The most difficult portions to design were the semi-circular ends of the building. Grow spent many nights pacing the floor trying to figure out how he could build radial trusses around the semi-circular ends of the building and bring them to a true common joint.<sup>44</sup> His solution was "an effective piece of homely ingenuity."<sup>45</sup>

Grow's design is especially impressive considering that he drew no plans for the roof and did not know how he would build the end

---

<sup>42</sup>"Henry Grow" in Jenson, *Latter-day Saint Biographical Encyclopedia*, 3:95-96. Although no year is mentioned for this appointment, it was during the presidency of John Taylor.

<sup>43</sup>For detailed descriptions of the roof, see Carter, *The Great Mormon Tabernacle*, 13-4; and Levi Edgar Young, *The Great Mormon Tabernacle with its World-Famed Organ and Choir* (Salt Lake City: Bureau of Information, 1917).

<sup>44</sup>Grow, *A Tabernacle in the Desert*, 41.

<sup>45</sup>Carl W. Condit, "The Mormon Tabernacle," *Progressive Architecture*

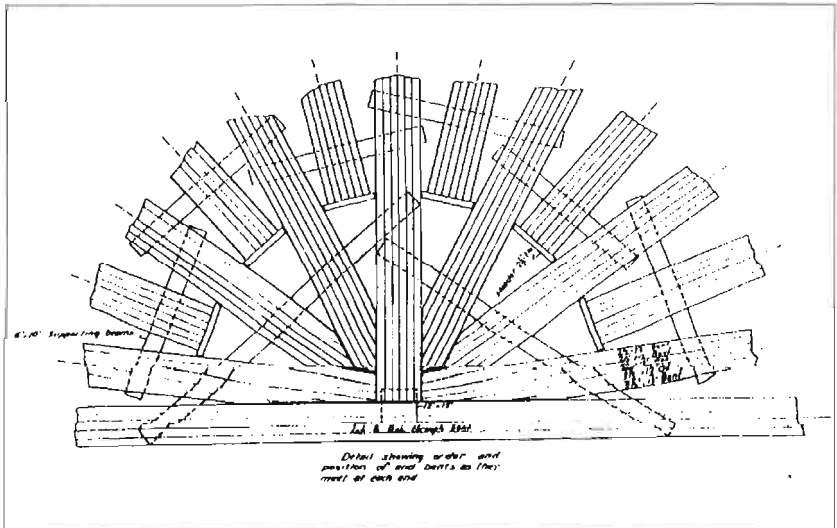

Grow's design to make the arches spring from the semicircular ends to meet at a common joint. According to Carl W. Condit, "The Mormon Tabernacle," *Progressive Architecture* 47 (November 1966): 160, "The center half-arch at each end abuts along its full depth and width against the crown of the last transverse arch, the two half-arches thus forming two quarter-ellipses. Three alternate half-arches in each quarter are wedge-shaped at the ends to abut against this joint. The remaining three arches in the quarter are brought up as close to the joint as possible without reducing the width of the truss, and the free ends [are] supported on supplementary beams disposed roughly in a triangular and a semicircular pattern." Drawing from Vern Melvin Brown and Legrand Haslam, "Engineering Investigation of the Great Mormon Tabernacle" (B.S. thesis, University of Utah, 1940), n.p.; used with permission of the J. Willard Marriott Library.

sections before he started on the main trusses. His son George said that Henry Grow "built it by details which he drew as he went along."<sup>46</sup> Attempting to build something as massive as the Tabernacle roof without complete plans was certainly unconventional, if not extremely risky. Some might see this act as one of great faith; others

47 (November 1966): 160.

<sup>46</sup>Quoted in Grow, "A Historical Study," 155.

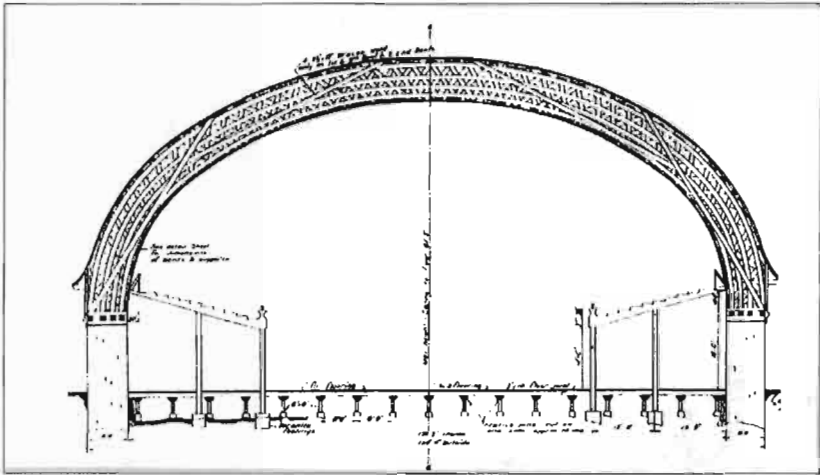

*Cross-section of the Tabernacle's width. Note the complex lattice woodwork in the roof, which can be attributed to Henry Grow. Drawing from Vern Melvin Brown and Legrand Haslam, "Engineering Investigation of the Great Mormon Tabernacle" (B.S. thesis, University of Utah, 1940), n.p.; used with permission of the J. Willard Marriott Library.*

might call it foolhardy.<sup>47</sup>

Newspaper articles from 1866 and 1867 indicate that Grow was in charge of construction on the Tabernacle during these years. Reporters sought him out for updates and information.<sup>48</sup> When the *Salt Lake Telegraph* published a lengthy feature on the Tabernacle on October 6, 1867, Grow provided the paper with the details of the construction. The article refers to Grow as the "designer and builder of the Tabernacle." But other evidence suggests that, as construction of the roof and the exterior neared completion, Angell may have supplanted Grow as supervisor. Various references in Angell's journal

<sup>47</sup>When Angell later became involved in the construction, he expressed his frustration with the earlier lack of planning. He believed the Tabernacle's design had "ben neglected" and complained that the construction was "advanced ahead of the detailed plan." Later he added, "I never saw a job more awkward to manage." Angell, Journal, April 28 and September 17, 1867.

<sup>48</sup>See, for example, *Deseret News*, March 29 and September 12, 1866.

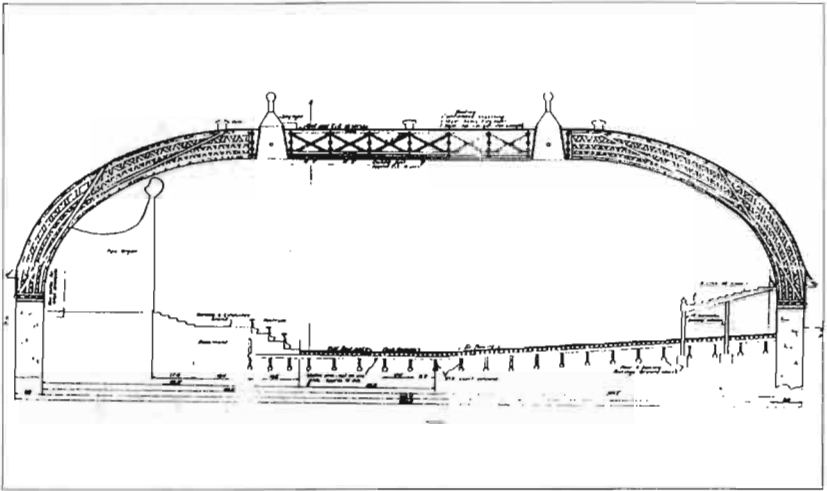

*Cross-section of the Tabernacle's length, including the nine lattice arch trusses that cross in its center. The speakers' stand is elevated and the floor is slanted to improve the audience's view. This was Brigham Young's desire, achieved by Truman Angell's interior design. Drawing from Vern Melvin Brown and Legrand Haslam, "Engineering Investigation of the Great Mormon Tabernacle" (B.S. thesis, University of Utah, 1940), n.p.; used with permission of the J. Willard Marriott Library.*

suggest that he was in charge of construction and that he gave orders to Grow rather than receiving orders from him.<sup>49</sup>

Angell also made a number of critical references to Grow in his journal. On two different occasions, Angell recorded that Grow had failed to complete assigned tasks: "Henry Grow is defishant for the task, and I feal driven to it,"<sup>50</sup> he wrote. When construction was nearing completion, Angell reflected, "Br. H. Grow has dun verry well indeed," but then added, "One of the principal faillieres with him is he does not watch his men work and show them how to do so as much as he watches to see if they are bussy at their work."<sup>51</sup> Angell obviously did not enjoy working with Grow. In a letter to Young, he called Grow's work sloppy and stated that he did not want his help on any fu-

<sup>49</sup>Angell, Journal, May 23, 28, and July 18, 1867.

<sup>50</sup>Ibid., August 22, 1867; see also September 27, 1867.

<sup>51</sup>Ibid., October 3, 1867.

ture projects.<sup>52</sup>

Although Angell cared little for Grow's style of work, contemporary historians gave him most of the credit for the Tabernacle in histories published soon after the building's completion. Orson F. Whitney called Grow the lone architect and Edward Tullidge said he "designed the shape, and planned, framed and put up and finished" the Tabernacle.<sup>53</sup> Only in more recent histories has the attribution of authorship been more confused and divided.

In 1934, Joseph Don Carlos Young, then Church Architect, argued that Grow should be considered an "engineer" on the Tabernacle project, but not the Tabernacle architect. He pointed out that while architects of large buildings often rely on steel engineers to design trusses or other support systems in the roof, such engineers are not considered architects.<sup>54</sup> Young based this redefinition on an assumption that architectural practice was the same in the 1860s as in the 1930s. However, as already pointed out, engineering and architecture were not such clearly differentiated *métiers* in the 1860s, and architects did not typically have engineers to aid them in design or construction.

Because Grow had control over the Tabernacle's roof design and supervised one stage of the construction, he should be recognized for his valuable contribution. The Tabernacle would be a very different structure without it.

#### TRUMAN ANGELL AND THE FINAL CONSTRUCTION STAGES

Truman Angell had no involvement in the Tabernacle's construction before 1866 but arrived on the scene in time to design the cornice and interior of the Tabernacle. He also supervised construction during the final stages.

Angell was born in North Providence, Rhode Island, in 1810. As a child he had a great interest in architecture, but his family lacked the funds to formally educate him. With other members of his family, he

---

<sup>52</sup>Truman O. Angell, Letter to Brigham Young, n.d., quoted in Charles Mark Hamilton, "Authorship and Architectural Influences on the Salt Lake Temple" (M.A. thesis, University of Utah, 1972), 87.

<sup>53</sup>Orson F. Whitney, *History of Utah*, 4 vols. (Salt Lake City: George Q. Cannon & Sons, 1893), 2:179; Edward W. Tullidge, *History of Salt Lake City* (Salt Lake City: Star Printing, 1886), 126.

<sup>54</sup>Joseph Don Carlos Young, "Statement," 1.

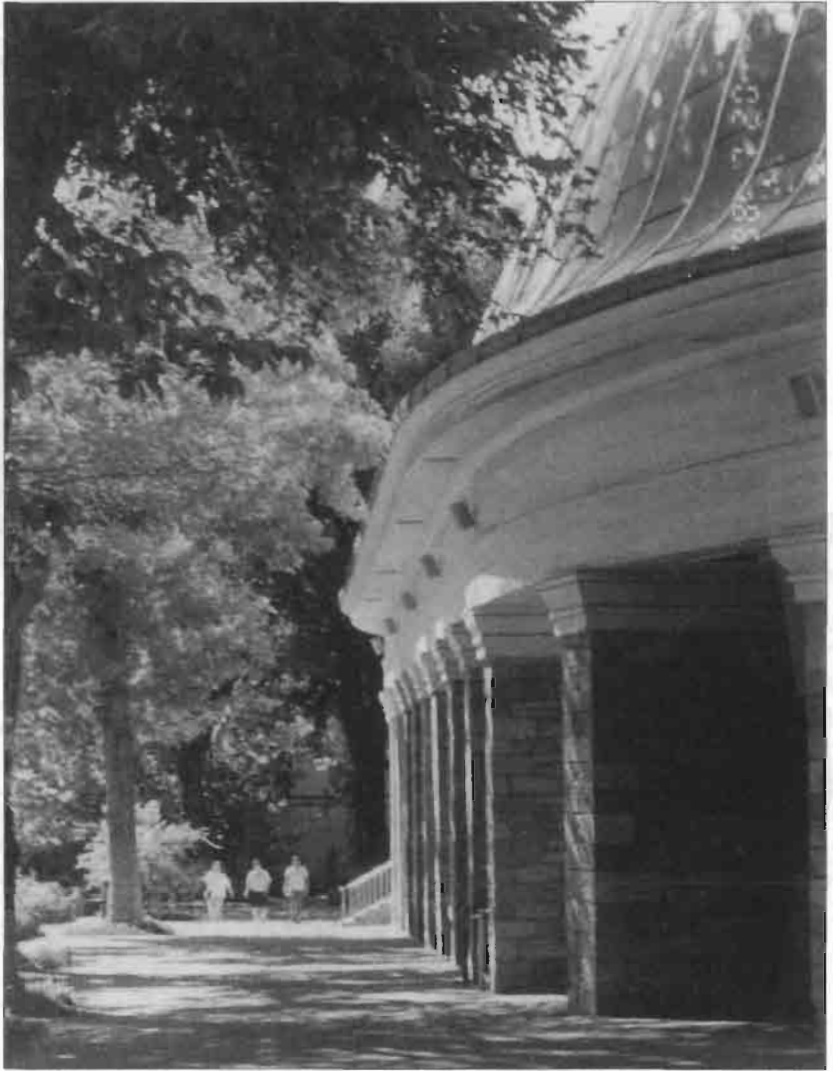

*The south side of the Tabernacle showing the huge sandstone pillars and Truman Angell's graceful cornice. Photo July 20, 1998, by Nathan D. Grow.*

converted to Mormonism in 1832 and learned his trade on numerous Church construction projects. As the only man to play a major role in the construction of the Kirtland, Nauvoo, and Salt Lake temples, Angell left his mark on early Mormon architecture. He was a joiner (carpenter) for the Kirtland temple, "superintendent of joiner work," for the Nauvoo Temple, and architect of the Salt Lake Temple.<sup>55</sup> Angell was also the architect of the Old Tabernacle, the Endowment House, and the Lion House.

Angell served for many years as the Church Architect even though he confessed to feeling under-qualified.<sup>56</sup> Other more talented architects had either left the Church or could not handle the stress and frustration that came with the job. Young tried to help him become better qualified by sending him on a mission to Europe to study architecture from 1856 to 1857. Though he was "obviously lacking in terms of certain architectural skills,"<sup>57</sup> Angell proved valuable to the Church because of his willingness and devotion to his work. When he died in 1887, he was probably the most beloved architect in Utah.

By the late summer and fall of 1866, Angell was tired of farming and decided to work as a joiner on the Tabernacle. But "the cold days of late fall sent me . . . back to the farm. Here I staid till spring or April conferrance, some 5 months and did not do a days work" on the Tabernacle.<sup>58</sup> In April, Angell was called out of retirement to take Folsom's place as Church Architect and Folsom was retained as his assistant.

During April 1866 general conference when Angell was sustained as Church Architect, Young set the goal of having the Tabernacle ready for use in time for October general conference. At that time, the building was probably less than half completed, and the deadline was obviously unrealistic; but it provided the psychological advantage of mobilizing energies and strengthening commitment. A large number of workers responded to the call for labor. At the height of con-

---

<sup>55</sup>Anderson, "Truman O. Angell," 137; Truman O. Angell, "Autobiography," LDS Church Archives. Hamilton, "Authorship and Architectural Influences," 89, disputes the scholarly consensus that Angell was the Salt Lake Temple architect.

<sup>56</sup>Angell, *Journal*, September 20, 1867.

<sup>57</sup>Hamilton, "Authorship and Architectural Influences," 73.

<sup>58</sup>Angell, *Journal*, April 18, 1867.



struction over the spring and summer of 1867, as many as 205 workers swarmed over the building. On July 7, 1867, the *Salt Lake Telegraph* printed a call for plasterers, masons, and laborers, a sign that the finishing work was beginning. As many as seventy men were employed at one time to plaster the ceiling. Cattle hair mixed with the plaster made it stronger and helped somewhat to reduce echoes. The doors and windows, also installed during this phase, used about 2,500 panes of glass.<sup>59</sup>

Apparently little thought had been given to the building's interior design before Angell was put in charge of the project. During this final rush, Angell made several interior drawings, half a dozen of which have survived. These are in fact the only original drawings of the Tabernacle still known to be in existence.<sup>60</sup> Angell also spent a good deal of time supervising and instructing the other workers. He wrote in his journal, "I am much called on all the time by Foreman Grow and the shop men."<sup>61</sup>

Construction continued right up until October 1867 general conference with the ceiling scaffolding being removed only on October 3, three days before the conference began. This moment of rejoicing was darkened by the death of Angell's son Franklin on October 2, but he recorded in his journal on October 4: "The house is ready for use." The famous Tabernacle organ was still under construction and benches from other meetinghouses had to be used since all of the new ones had not yet been made, but the historic first conference was held as scheduled.

Even though the Tabernacle was operational in 1867, it was not dedicated until 1875 when the organ and benches were installed and a gallery had been built, expanding the seating capacity to 10,000. Angell most likely designed the gallery, while Grow, Folsom, and Young probably had minimal roles in construction after 1867.

Because the Tabernacle was so large and sound amplification systems did not exist in the 1860s, the acoustics of the building were a concern during the construction. The overall design of the Tabernacle may have been planned with the idea of maximizing the reach of the speaker's voice, but the consideration of acoustical quality seems

---

<sup>59</sup>*Salt Lake Telegraph*, October 6, 1867.

<sup>60</sup>Truman O. Angell, "Drawings of the Salt Lake Tabernacle," LDS Church Archives.

<sup>61</sup>Angell, Journal, July 18, 1867.



*Tabernacle interior in 2002. Some of the original pine pipes, dating from the 1860s, were still in use. Truman Angell designed the U-shaped gallery that runs around the interior, terminating at the choir stand. Photo by Nathan D. Grow.*

to have been neglected.<sup>62</sup> As a result, many in attendance at that first general conference in October 1867 could not understand the speakers. The sound seemed to echo incessantly, muddling the speakers' words and amplifying even the quietest rustling among the audience. The gallery was constructed with the hope of improving the acoustics. Angell knew that, if he left a gap of thirty inches between the gallery and the wall, the acoustics would improve.

Ironically, the Tabernacle has since become renowned for its sensitive acoustical properties, and guides have enchanted visitors for decades by dropping a pin on the speaker's stand, to be heard clearly at a distance of over a hundred feet. During the 135 years that it has been home to the Mormon Tabernacle Choir and the famous organ, the Tabernacle has been associated in the public mind with excellent sound in its music. Weekly radio and/or TV musical broadcasts plus a sermonette have originated from the Tabernacle uninterrupted since 1929 in its renowned "Music and the Spoken Word" program. Richard Lyman, a representative from the American Society of Civil Engi-

<sup>62</sup>Condit, "The Mormon Tabernacle," 161.

neers, even went so far as to say, "The Tabernacle is popularly considered the most acoustically perfect structure of any magnitude in the world."<sup>63</sup> That is clearly an overstatement; the Tabernacle still has a few dead spots and its unusual sound reverberations have confused musicians and speakers alike. Nevertheless, Angell should receive credit for helping to make the Tabernacle unique for its acoustical properties.

Angell was the only man of the four "masters" to keep a regular diary of the project, and it records various complaints about the Tabernacle project. With obvious frustration, he wrote in 1867, "If I had charge of this building from the start it would ben my way to of found all the main troubles in a plan ahead of the work."<sup>64</sup> He also expressed what seems to be a somewhat petty concern about receiving credit for his efforts, although he is perhaps justified by the confusion that has since developed.<sup>65</sup> When a newspaper article gave most of the credit to Grow, an angry Angell discussed the issue with both Grow and the editor. A week later, another article reported that Angell had "draughted the whole of the interior portions of the building and detailed the same on the trustle [sic] board for practical execution and likewise superintended the workmanship thereof as chief foreman, until the opening of the building at Conference."<sup>66</sup>

Angell may have been overly hungry for recognition, but he honestly deserved it. He should be recognized for designing the interior, supervising construction during the final stages, and finishing the project nearly a decade after the first conference convened there in 1867.

#### CONCLUSION

Over the years, the Tabernacle has received a number of makeovers, but the primary elements of the building (the interior structure of the roof, the pillars and the basic interior design) have required minimal maintenance. Heating and electrical systems have been installed. The wooden shingles were replaced once with copper

---

<sup>63</sup>Richard R. Lyman, "The Mormon Tabernacle and Temple," Summer Meeting of the American Society of Civil Engineers, 1925, Salt Lake City.

<sup>64</sup>Angell, Journal, June 19, 1867.

<sup>65</sup>Ibid., April 27 and October 7, 1867.

<sup>66</sup>*Salt Lake Telegraph*, October 6 and 13, 1867.

sheeting around 1900 and then, in 1947, with aluminum. In 1968, a basement was added to facilitate radio and TV equipment. The Tabernacle was designated as a National Historic Landmark in 1970 and became the first building to be designated as a National Civil Engineering Landmark in 1971.<sup>67</sup> Until April 2000, the Church used the Tabernacle for general conferences and thereafter continued its use for concerts and other important civic events. The Church is currently in the midst of a major renovation of the Tabernacle in order to reinforce the sandstone pillars, secure the roof to the pillars, and bolster the foundation, retrofitting it to meet modern earthquake codes.<sup>68</sup>

Having considered the historical evidence, it is clear that Brigham Young, William Folsom, Henry Grow, and Truman Angell all contributed to the construction of the Tabernacle. Young provided the general shape of the building, Folsom drew the original plans, Grow designed the roof, and Angell took charge of the interior. Additionally, all four supervised the construction to varying degrees. Having each contributed significantly to the design and construction, they should all, in my view, be called the architects. The Tabernacle is a unique orchestration of the contributions of all four. If any part of the building were changed or subtracted, it would destroy its harmonious balance. Four masters were needed to create this masterpiece.

#### APPENDIX

##### SELECTED STATEMENTS ON THE TABERNACLE'S AUTHORSHIP

The following list of statements about the authorship of the Salt Lake Tabernacle is selected from various proponents of one or the other of the building's four architects. They are listed chronologically according to the date of writing.

"William H. Folsom and Salt Lake Tabernacle," Unpublished manuscript with photograph, n.d., LDS Church Archives: "[Brigham Young] said to Wm. H. Folsom, Architect of the Church, 'We must have a large place to assemble in, and I've been thinking of a building with a roof like this (raising his umbrella,) or turtle back, or half an egg, as a bowery for summer use, and

---

<sup>67</sup>Rex E. Cooper, "Tabernacle, Salt Lake City," *Encyclopedia of Mormonism*, 4 vols. (New York: Macmillan, 1992), 4:1434.

<sup>68</sup>Heather May, "Tabernacle Work Order: 'Be Careful,'" *Salt Lake Tribune*, October 2, 2004.

closed with doors for winter use. Can you plan and draw such a building?' 'I think so, and I will try.' In about three months, plans were submitted showing a design of elyptic arch of ancient lattice work on 44 piers, which pleased President Brigham Young, and he said, 'Brother Henry Grow understands lattice work, and we will have him build it.'"

Orson F. Whitney, *History of Utah*, 4 vols. (Salt Lake City: George Q. Cannon & Sons, 1893), 2:179: "The architect of the Tabernacle, under Brigham Young, was Henry Grow, who also had charge of its construction."

*Deseret Evening News*, March 10, 1901: "While it was the genius of the great Pioneer leader [Brigham Young] that conceived the wonderful Tabernacle it was William Folsom who took the suggestions of his chief and perfected the plans."

Susa Young Gates, *The Life Story of Brigham Young* (New York: Macmillan, 1930), 228: "Truman O. Angell was the architect, and William H. Folsom the assisting architect of this most unique structure. . . . Brigham Young planned it and his associates and friends built it. If he were asked, however, 'Who was the architect, the designer of the Tabernacle and the Temple?' he would answer at once and with solemn intonation, as he always did: 'God is the Supreme Architect. We owe all our inspiration, our love of beauty and the knowledge of how to express our views to the Father in Heaven who gives to His children what they ask for and what they need.'"

Joseph Don Carlos Young, "Statement, November 12, 1934," 1, LDS Church Archives: "Inasmuch as there has been some misapprehension in regard to who was the architect for the large Tabernacle in Salt Lake City, I desire to emphatically state that Truman O. Angel, Sr., was the designer and made the drawings for this building.

"As evidence of this fact, I find in the files of old drawings in the Church Architect's office, two sheets of the original drawings, both signed by T. O. Angel, Architect. . . .

"Before the Tabernacle was dedicated, Truman O. Angel resigned as Church Architect in order to go on a mission to Great Britain. William H. Folsom was sustained at that time as Church architect and was present when the building was dedicated, which no doubt led many to think that Folsom was the architect of the building.

"In regard to Henry Grow being the architect of the Tabernacle, this is entirely erroneous. However, he designed the roof trusses, which were similar to a truss he had designed for the old white bridge over the Jordan River, known as the Remington Patent Lattice Truss."

Andrew Jenson, *Encyclopedic History of the Church of Jesus Christ of Latter-day Saints* (Salt Lake City: Deseret News, 1941), 2:858: "The tabernacle was planned and erected under the direction of Pres. Brigham Young, with William H. Folsom as architect and Henry Grow as master mechanic."

Nellie Grow Forman, Midvale, Utah, Letter to John H. Taylor, Salt Lake City, May 27, 1943, typescript, LDS Church Archives: "[Brigham Young said:] 'There are so many Saints come we need a larger building to hold them all.' He turned to Father [Henry Grow] and said, 'Henry, can you build a big building?' Father said, 'I think I can.' President Young then said, 'Could you build one like this?' At the same time he placed his open umbrella on the ground to indicate the shape. Father said, 'No I couldn't.' 'Well, how large can you build one?' 'Two hundred and fifty feet wide and as long as you want it.' Brigham Young said, 'I would like a building so everybody could see and hear the speaker. Do you think you could build such a building?' Father said, 'Yes, I can.' 'Then you decide on the size, Henry. I'll see that you get all the men and materials you need and will turn it over to you. You go ahead with it.'"

Stewart L. Grow, "A Historical Study of the Construction of the Salt Lake Tabernacle" (M.A. thesis, Brigham Young University, 1947), 145: "In discussing the subject of this thesis with Mr. Gordon Hinckley, publicity official for the Latter Day Saints Church, the conversation turned to the question of who was the architect of the Salt Lake Tabernacle. He indicated that in his experience with publicity on the point, a compromise had been reached in which it was indicated that Henry Grow and Wm. Folsom cooperated on the design under the general instruction of Brigham Young. He added that so far as he knew there was no historical basis for the compromise, but that it had been arrived at as a result of family pressures and the lack of historical proof to the contrary."

Grow, "A Historical Study," 145-46: "Truman O. Angell was the architect of the interior of the building, including the stand, seating arrangement, doorways, stairways and other finishing details. This is evident from his journal entries. . . . The question remains then, who designed the exterior of the Tabernacle? There are two persons who are given credit for the design, Henry Grow and Wm. Folsom. The author has found no material which will make the claim of either of the men incontrovertible." [Stewart Grow goes on to explain why it is much more likely that Henry Grow was the architect of the exterior.]

(November 1966): 160: "The idea of a domed and vaulted roof enclosing the whole interior area without intermediate supports is attributed to Brigham Young himself, but it required a team of three designers to translate the concept into working plans. William H. Folsom was the architect in charge of the total project; Truman O. Angell, official architect of the Latter-Day Saints Church, planned the interior, and Henry Grow designed the roof structure and supervised its construction."

Kate B. Carter, *The Great Mormon Tabernacle* (Salt Lake City: Daughters of Utah Pioneers, 1967), 7: "Although through the years some dissension has existed as to which individual played the greater part in bringing into existence the magnificent Tabernacle on Temple Square, conscientious examination of the great mass of available information has led us to believe that four men should share equally in the laurels: Brigham Young for his foresight in realizing the need for such a building, and his genius in planning it; William H. Folsom for his masterful handling of the exterior; Henry Grow who directed the building of the unique and distinguished roof; and Truman O. Angell, who with great finesse completed the interior."

Charles Mark Hamilton, "Authorship and Architectural Influences on the Salt Lake Temple" (M.A. thesis, University of Utah, 1972), 87: "The design of the domed structure originated in a sketch by Brigham Young and was carried out by William Folsom, who was at the time acting church architect. Construction began the following year, under the direction of Henry Grow, a convert and accomplished bridge builder from Pennsylvania. . . . When the Large Tabernacle was dedicated on October 6, 1867, the acoustics of the structure proved inadequate. Brigham Young approached Truman Angell, Sr., who had just come out of retirement, and asked him to resolve the problem. Angell's innovative solution was equal to that of Grow's structural design for the dome: he constructed a thirty-foot-wide gallery and wall to help eliminate the problem of recurring echoes."

Nina Folsom Moss, *A History of William Harrison Folsom* (Salt Lake City: William Harrison Folsom Family Organization, 1973), 45: "[We should credit William Folsom for] his ability in translating President Young's vision into well-drawn plans and masterfully executing the architect's duties in seeing the vision properly interpreted in the building exterior." [Moss quotes Kate Carter, cited above, who credits all four architects, but she obviously believes that Folsom was the real architect.]

Paul L. Anderson, "William Harrison Folsom: Pioneer Architect," *Utah Historical Quarterly* 43 (Summer 1975): 248: "Folsom's work on the

building seems to have been limited to the preparation of general plans. Henry Grow, a bridge builder who had purchased the right to use the patented lattice truss before coming west was superintendent of construction on this project, and the exterior cornice and the interior finish of the building were the work of Truman Angell.”

Franklin T. Ferguson, “Architecture,” *Encyclopedia of Mormonism*, 4 vols. (New York: Macmillan, 1992), 1:64: “The Salt Lake Tabernacle, designed by Truman O. Angell assisted by William H. Folsom and Henry Grow, remains the ideal of architectural integrity and is the zenith of Mormon architecture.”

Craig Wilkenson, interviewed by Nathan Grow, October 21, 2002: “I would probably call William Folsom the architect and Henry Grow the structural engineer. . . . If somebody asked me who was the architect I would say William Folsom.”



# THE SALT LAKE TABERNACLE IN THE NINETEENTH CENTURY: A GLIMPSE OF EARLY MORMONISM

*Ronald W. Walker*

This decent, pious host  
Rises *en masse*, as the grand organ rolls,  
Praise to the Father, Son, and Holy Ghost!  
—H. Buss<sup>1</sup>

THE SALT LAKE TABERNACLE—that grand old dame of pioneer Utah—has a story to tell, if only we have enough curiosity to seek it. Set on a rolling slope at Church headquarters, during the nine-

---

RONALD W. WALKER {ronald\_walker@byu.edu}, a member of the History Department at Brigham Young University and a past president of the Mormon History Association, is the author of *Qualities That Count: Heber J. Grant as Businessman, Missionary and Apostle*, a special issue of *BYU Studies* 43, no. 1 (2004) and coauthor of a forthcoming study of the Mountain Meadows Massacre.

Acknowledgments: When preparing this article, I incurred debts to several research assistants: Steven Arrowsmith helped find many obscure sources dealing with the Tabernacle; Christine Edwards Allred researched and wrote a preliminary draft; and Bruce Lott helped to verify the text's many citations. Many of the travelers' quotations that appear in Allred's manuscript also appear in this article.

<sup>1</sup>H. Buss, *Wanderings in the West, During the Year 1870* (London: Printed for Private Circulation by Thomas Danks, 1871), 160.

teenth century it towered above the surrounding landscape, especially before the growth of trees and shrubs and other buildings closed off the view of it. Its presence was more than physical. The Tabernacle was, after all, the most important public building of the Church of Jesus Christ of Latter-day Saints in the last part of the nineteenth century. It was where the Saints came to worship each Sunday, weather permitting. It was also where thousands of outsiders came to see Mormons firsthand; and after their visits, they recorded details that Zion's own men and women often failed to mention. In short, the Tabernacle was where early Mormonism revealed itself to contemporaries—and now to historians, especially if we have a willingness to use such sources as tourists' accounts and old photographs as primary documents. The result can be fascinating social history and an important study of material culture on a grand scale.

Because the shape of the building was so odd, many people have given unusual reasons for its design. One tale says that a hard-boiled egg at President Brigham Young's breakfast inspired the roof. However, a building is best understood not by its lore but by its pedigree, and in the Tabernacle's case, its ancestry is not hard to trace. Before Joseph Smith's death, he commissioned a "tabernacle" to be built just west of the Nauvoo Temple. Smith envisioned a building perhaps 250 feet long and 125 feet wide, and his followers took steps toward a makeshift version of the project that required 4,000 yards of canvas, only to abandon their task when they were forced to evacuate their headquarters and move west.<sup>2</sup> However, the idea lingered. The Mormons were a precedent-minded people, especially when it came to Joseph Smith's ideas, and they later used the name "tabernacle," shape and approximate size, and layout (west of a temple) when building the Salt Lake Tabernacle. In fact, the later building's dimensions were almost identical to those of its predecessor, being only a few feet smaller in width.

The westward-migrating Mormons built tabernacles on their way to the Great Basin, including one at Kanesville, Iowa.<sup>3</sup> More significant were the makeshift pavilions built on Temple Square in Salt Lake City. These open-air halls were called bowers or "boweries" for

---

<sup>2</sup>Elden J. Watson, "The Nauvoo Tabernacle," *BYU Studies* 19 (Spring 1979): 416–21.

<sup>3</sup>Gail George Holmes, "The First Mormon Tabernacle Is Rebuilt in

the evergreen branches placed on poles to form a sort of roof. For seats, the settlers used pine benches, some backed and others unbacked, on which the better-off worshippers put hair or "cornshuck" cushions. Kerosene lamps furnished light. During the pioneer period, the settlers constructed five of these makeshift structures, including one built at their initial fort. The largest and most enduring, built in the early 1860s, may have held more than 8,000 people.<sup>4</sup> It had a speaking rostrum that resembled the stage of a "good-sized theatre." A somewhat forlorn-looking table, too small for the space surrounding it, served as a podium, behind which Church leaders sat in cane settees and chairs.<sup>5</sup>

Another forerunner to the Tabernacle was the "Old Tabernacle," built in 1851–52. The building occupied a location on Temple Square's southwest precinct, its longest side running north and south. "None of us had ever seen the like," said one startled Oregon emigrant, who saw it shortly after its construction.<sup>6</sup> Other travelers used words like "barn-like," "unpretending," and "commodious and cheap" to describe the meeting house.<sup>7</sup> Another traveler was less diplomatic. To him, it seemed "odd-looking" and had no "pretense evi-

---

Kanesville, Iowa," *Nauvoo Journal* 8, no. 2 (Fall 1996): 71–73.

<sup>4</sup>Melvin L. Bashore, "Historic Temple Block Buildings," unpublished LDS Historical Department memorandum, May 24, 1999. The 8,000 estimate for the capacity of the 1861 bowery is found in John Hyde, "Salt Lake and Its Rulers," *Harper's Weekly* 1 (July 11, 1857): 442. Mormon estimates were often higher, perhaps because they included infants and children as well as those unable to find a seat in the bowery but who stood "in and around" the structure. See "Fourth of July, 1855," *Deseret News*, July 4, 1855, Journal History of the Church of Jesus Christ of Latter-day Saints (chronology of typed entries and newspaper clippings, 1830–present), Archives, Family and Church History Department, Church of Jesus Christ of Latter-day Saints, Salt Lake City (hereafter LDS Church Archives).

<sup>5</sup>Bashore, "Historic Temple Block Buildings." Also see Hyde, "Salt Lake and Its Rulers," 442; "Fourth of July," *Deseret News*, "Journal History," July 4, 1855; and Fitz Hugh Ludlow, *Heart of the Continent* (New York: n. pub. 1870), 507.

<sup>6</sup>"From Lake Erie to the Pacific—An Overland Trip in 1850–51. . . [Reminiscence of an Overland Journey to Oregon via Salt Lake City]," manuscript, Huntington Library, San Marino, Calif.

<sup>7</sup>Samuel Bowles, *Our New West: Records of Travel between the Mississippi*

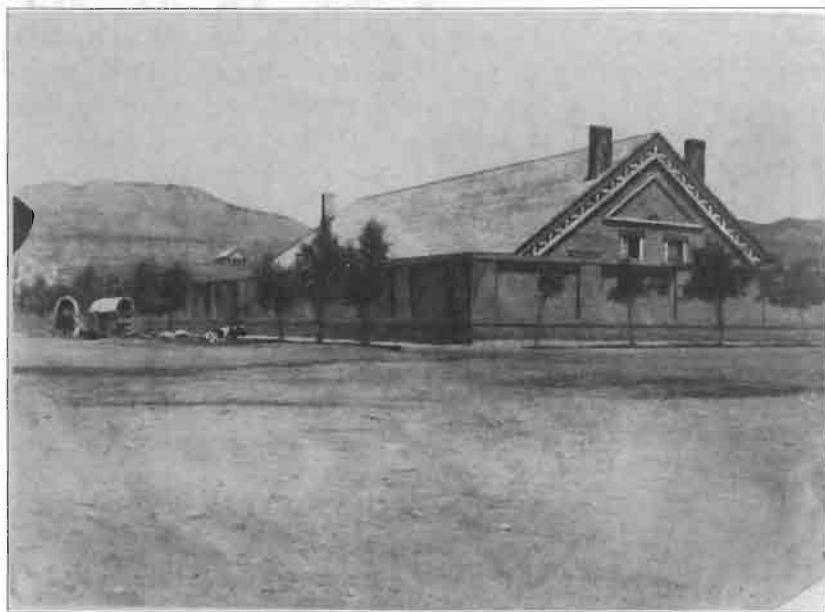

*The Old Tabernacle with Greek Revival-style trim on its end, mid-1850s. Photograph by David A. Burr (1838–1891), courtesy LDS Church Archives (PH676-3-8).*

dently to any of the known order of architecture.”<sup>8</sup> Mormons would not have argued the point. They had hastily built the Old Tabernacle as a stopgap measure until something larger and more lasting could be built. Brigham Young himself called the 66-by-166 foot building “plain” and “simple.”<sup>9</sup>

“In entering its steps descend,” said California emigrant Addi-

---

*and the Pacific Ocean* (Hartford, Conn.: Hartford Publishing Company, 1869), 220; Solomon Nunes Carvalho, *Incidents of Travel and Adventure in the West* (New York: Derby and Jackson, 1857), 208; and Henry Kendall, “A Week in ‘Great Salt Lake City,’” *Hours at Home* 1 (May 1856): 65.

<sup>8</sup>James F. Rusling, *Across America: or, The Great West and the Pacific Coast* (New York: Sheldon & Company, 1874), 165.

<sup>9</sup>Brigham Young, Sermon, October 7, 1852, unpublished manuscript, General Church Minutes, LDS Church Archives. For the building’s dimensions, see Brigham Young, Letter to John Murdock, April 2, 1852,

son Moses Crane.<sup>10</sup> Perhaps in a bid to cut costs and to insulate against the extremes of the Great Basin's weather, the Mormons designed much of the interior to be below ground level, including all of its seats. Thus, seen from the outside, the building had a squat appearance, its vertical rise disproportional to its length and width. The grayish-brown hue of its adobe siding further added to its drab aspect. However, the building had some ornamentation. Four large doors—two on the south and two on the north—provided visual interest. Above these doors were four rectangle windows, which, although one traveler thought them “prison-like,” could give off prisms of light on a sunny day.<sup>11</sup> Above the doors and windows, the cornice had a leaf-like design, under which, at least on the south facade, rested a carved yellow-orange sunburst. This motif was apparently a symbol of effulgent gospel rays.<sup>12</sup>

Whatever its outward quality, the Old Tabernacle was a minor engineering success, particularly its free-standing ceiling. Rather than support the ceiling with internal columns, Church architect Truman O. Angell designed a system of arching beams that held the roof in place by an attached network of trusses. I “found it uncommon[ly] strong,” Angell wrote in his diary after building a model to test his lattice truss design. It is “good to bear 8 or 10 times besides the weight of the roofing.”<sup>13</sup> As each of the eleven structural beams or bents was raised and placed, the settlers proclaimed the event as a matter of civic pride. When the last beam was positioned, a flag was hoisted on top of the new building to signal that “the timbers were up.” That evening, perhaps to celebrate, a noted bandmaster, “Professor Ballo,”

---

Draft Letterbook, Brigham Young Papers, LDS Church Archives. The smaller dimension of 60 by 120 feet is suggested in Brigham Young, Office Journal, December 16, 1851, LDS Church Archives, and in a notice published in the *Deseret News*, May 17, 1851, 261. During the building's construction, the dimensions were evidently modified and enlarged.

<sup>10</sup>Addison Moses Crane, “Journal of Trip from LaFayette, Indiana, to Volcano, California, via Fort Laramie, Salt Lake City, and the Humboldt River,” manuscript, Huntington Library.

<sup>11</sup>Rusling, *Across America*, 165.

<sup>12</sup>Isaac Foster, Letter, in Roxana Cheney Foster, *The Foster Family: California Pioneers* (Santa Barbara, Calif.: Schauer Printing Studio, 1925), 136.

<sup>13</sup>Truman O. Angell, Diary, December 15, 1851, LDS Church Archives.

hosted a grand military ball at the Bath House.<sup>14</sup> Six months later, the Mormons were still pleased with their achievement. "The whole [roof is] one entire arch sprung from the base," the First Presidency told Church members living outside Utah.<sup>15</sup> Outside the roof was pitched or peaked; inside it was a long, sloping oval, without any obstructing poles.

Those who liked the building were willing to look beyond its strangeness. California emigrant Lucy Rutledge Cooke, corresponding with her sister in the East, described the Old Tabernacle as "a beautiful large building very plain and neat but a better one for accommodating an audience of 2500 I never saw. There are four large doors one at each corner which makes a good breeze through. There are no galleries but the seats are all raised from the front up where the speakers are. I have been once on a Sunday. The singing is so nice. It is led by an English band [choir] who sings good old English tunes. The place is always full."<sup>16</sup>

It was precisely this last fact that made Brigham Young speak of the need for a larger meeting hall almost as soon as the Old Tabernacle was dedicated. According to Young's calculation, the building could hold only 2,260 adults (from 120 to 175 pounds each)—fewer than the many people who might wish to attend the city's weekly Sabbath service and far fewer than the number who attended the Church's general conference.<sup>17</sup> Another flaw was the Old Tabernacle's unbearable heat in the summer, if no breeze freshened the air. Because of these reasons, the Mormons continued to use their boweries in the middle 1850s and 1860s during the summers or for conferences. However, when conditions were wet or cooler, the Saints reverted to the Old Tabernacle.

In 1863 work was begun on a new tabernacle, which in time simply became known as the Tabernacle. The new building was as peculiar as its predecessors and, in fact, owed a debt to both the previous

---

<sup>14</sup>Journal History, December 12, 1851.

<sup>15</sup>"Seventh General Epistle of the Presidency of the Church of Jesus Christ of Latter-day Saints," April 18, 1852, in *Messages of the First Presidency of the Church of Jesus Christ of Latter-day Saints*, edited by James R. Clark, 6 vols. (Salt Lake City: Bookcraft, 1965-70), 2:92.

<sup>16</sup>Lucy Rutledge Cooke, Letter to unnamed sister, June 18, 1852, California Historical Society, Sacramento, Calif.

<sup>17</sup>Young, Sermon, April 7, 1852.

boweries and to the Old Tabernacle. As already noted, the Tabernacle was about the same size as the projected Nauvoo bowery, and its form and function were essentially those of a bowery, only built with permanent material and having a permanent roof. Once more, Young wanted no view-obstructing poles; and for a time, an Old Tabernacle-like pitched or peaked roof was considered, with three octagonal domes or ventilators. Church architect William H. Folsom drew the plans, although Young served in a general way as his own architect, as he reportedly claimed. "The form of the building was the design of President Brigham Young," wrote a newspaper correspondent, who inquired when the building was nearly finished. Young "was desirous that the lattice work principle should be introduced into the construction of this large edifice."<sup>18</sup>

It soon became apparent that the roof designed by Folsom would not easily work for a building so wide and low as the contemplated new hall. As a result, Church leaders decided on an innovative, self-supporting oval dome for the Tabernacle—essentially a rounded top placed upon a bowery. When building the Tabernacle's roof, workers used the Old Tabernacle precedent of arching "bents" or beams, but now the horizontal plane of the bents was greatly widened. Moreover, the crisscross lattice of supporting ties was multiplied to support the greater mass of the new roof. Fortunately, Utah had a man for such a job. Prior to coming west, Henry Grow had built bridges in Pennsylvania; and when he arrived in Utah, he claimed to have brought with him the right to use the patented Remington lattice technique.<sup>19</sup> Grow superintended the construction of the new roof and other parts of the building as well.

The Tabernacle's roof lattice was held together by well-greased

---

<sup>18</sup>*Salt Lake Daily Telegraph*, April 6, 1867, 1; Brigham Young, Office Journal, December 2, 1861, LDS Church Archives; Journal History, June 3, 1863, 1; and Paul L. Anderson, "William Harrison Folsom: Pioneer Architect," *Utah Historical Quarterly* 43 (Summer 1975): 248. See discussion on the Tabernacle's authorship in Nathan D. Grow, "One Masterpiece, Four Masters: Reconsidering the Authorship of the Salt Lake Tabernacle," this issue.

<sup>19</sup>Stewart L. Grow, *A Tabernacle in the Desert* (Salt Lake City: Deseret Book, 1958), 36. However, standard historical treatments of American bridge design and construction fail to mention the Remington technique or any patent associated with it. Grow's claim to have the right to such a proce-

wooden pins, about one-thirty-second of an inch larger than the holes they were meant to fill. These pins were then “driven home with sledges and wedged at each end.”<sup>20</sup> If the process split the beams, which it often did, workers wrapped the damaged lumber with strips of green rawhide, which, upon seasoning, shrank to hold the wood firmly in place. This resulting lattice (in some places nine feet thick) rested upon the beams extending from a series of red sandstone piers that ran along the sides of the building to provide footings. These piers were about twelve feet apart and three feet wide, nine feet long, and twenty feet high.<sup>21</sup> From a distance, they had the appearance of columns.

At first the Mormons covered the exterior with slate-colored wooden shingles, perhaps as many as 350,000.<sup>22</sup> These shingles were stained with a solution of lime, lamp black, tallow, and salt, which gave the building a dark aspect.<sup>23</sup> However, after the Tabernacle was nearly ignited by an 1883 explosion in a nearby wagon yard and, in 1887, by a spark from a fireworks display, the shingles were replaced by tin sheeting and still later by a series of metal roofs.<sup>24</sup>

Church leaders hoped to make short work of the building’s construction. But the piers had to settle, and seasoned lumber for the huge beams was not easy to come by. It was therefore not until 1867 that the Saints met in their new building, and then it was unfinished. Its eastern end doors still required work, and the congregation apparently did not have the comfort of new benches. The need to finish the building’s exterior and interior, including a sweeping gallery built in 1870, and perhaps most importantly, to complete the mammoth or-

---

ture may have been a marketing device to further his Utah reputation and business.

<sup>20</sup>Brigham Young, Letter to Frank Low, May 4, 1872, Brigham Young Letterbooks, LDS Church Archives. Grow’s *A Tabernacle in the Desert* details the construction of the new building.

<sup>21</sup>Young, Letter to Low, May 4, 1872.

<sup>22</sup>*Salt Lake Daily Telegraph*, October 6, 1867, 2; Levi Edgar Young, *Report of the Semi-Annual Conference of the Church of Jesus Christ of Latter-day Saints*, October 8, 1922 (Salt Lake City: Church of Jesus Christ of Latter-day Saints, semi-annual), 111 (hereafter cited as *Conference Report*).

<sup>23</sup>*Salt Lake Daily Telegraph*, May 23, 1867, 3.

<sup>24</sup>Wilford Woodruff, Diary, June 21, 1883, LDS Church Archives; *Deseret Evening News*, October 21, 1890, 204.





*The lattice-work beams of the Tabernacle roof in cross section. Note the wooden pegs in the beams and the rawhide strips around the upper plank over a crack. Photographer unknown. Courtesy LDS Church Archives.*

gan put off the dedication until 1875, when Elder John Taylor gave one of the Mormons' hallowing, down-to-the-last detail prayers, which defined the building's use. "We . . . dedicate and consecrate this house unto thee," Taylor intoned, "as a place of worship for thy Saints, wherein thy people may assemble from time to time, . . . to observe thy holy Sabbath, to partake of thy holy Sacrament of the Lord's supper, and wherein they may associate for the purpose of prayer, praise and thanksgiving, . . . and whatsoever purpose thy people shall assemble in thy name."<sup>25</sup> Twenty years had gone into the planning and construction, although most of the work had taken place during 1864–70.

The completed Tabernacle was 250 feet long, 150 feet wide, and 80 feet high at its apex and had a seating capacity much larger than

---

<sup>25</sup>"Semi-Annual Conference—Fourth Day," *Deseret Evening News*, October 9, 1875, 2.



*In about 1865, three complete spans of the lattice-work construction for the roof were in place, grounded on the sandstone pillars encircling the building. Photograph by Savage and Ottinger Photography Studio, LDS Church Archives (PH1404).*

the Old Tabernacle.<sup>26</sup> While estimates varied from 6,000 to 15,000, the Tabernacle's actual capacity depended on how numbers were tallied. Did figures include infants and children, usually a majority of the congregation? And did they include the people who packed the aisles and doors on special occasions? Even conceding that pioneer men and women were smaller than their modern counterparts and that women and not larger-framed men dominated early congregations, the Tabernacle's "comfortable" and "regular" seating capacity likely did not go much beyond 10,000.<sup>27</sup> A 1980 estimate put current

---

<sup>26</sup>Brigham Young, Letter to John Young, June 13, 1863, Brigham Young Letterbooks, LDS Church Archives.

<sup>27</sup>Mormons consistently put the building's capacity higher. One calculation shortly after the building's completion estimated that it could hold about 12,000, with another 2,000 to 3,000 able to stand in the outer aisles and doorways; "Fortieth Annual Conference," *Deseret News*, April 5, 1870, 2. Grow put the figure at 14,452, which included an estimate of 3,750 seats in the gallery that was completed in 1870. *Journal History*, September 4, 1877,



*The Salt Lake Tabernacle completed, about the time of the dedication in 1875, with granite blocks for the temple construction in the foreground. Courtesy LDS Church Archives (PH1060-2-1).*

seating for a modern audience at about 6,500.<sup>28</sup>

Everyone agreed that the building was big, especially for its time. Travelers to Salt Lake City used such words as “huge,” “extraordinary,” “immense,” and a “monster in size” to voice their awe.<sup>29</sup> Another visitor believed that the Tabernacle’s dome was “the largest self-supporting roof in the world,” although others held out New York City’s train depot or the military drill shed in St. Petersburg, Russia,

4.

<sup>28</sup>Hal White, Memo Prepared for the Operations and Maintenance Division of the Physical Facilities Department, August 8, 1980; photocopy in my possession.

<sup>29</sup>For “huge” and “extraordinary,” see Karl Baedeker, ed., *The U.S. with an Excursion into Mexico* (New York: Charles Scribner’s Sons, 1893), 426; “immense,” M. V. Moore, “The Great Salt Lake and Mormondom,” *Frank Leslie’s Popular Monthly* 39 (March 1895): 286; and “monster in size,” Raymond Hoyt Seeley, “The Mormons and Their Religion,” *Scribners* 3 (1872): 398.

as rivals and possible superiors to the title.<sup>30</sup> Nelson A. Miles, Commanding General, U.S. Army (1895–1903), saw the building’s vastness on his own terms; it seemed “sufficient to permit the drilling of a regiment of men.”<sup>31</sup> Still another used verse to describe the Mormon marvel’s amazing profile: “[O]’er the foliage thick / Oval in form—so high, for miles is seen / Colossal in its width as well as length.”<sup>32</sup> It was, in fact, one of the largest auditoriums in America when it was first built, and certainly was the largest without interior, supporting columns.<sup>33</sup>

Admiration for the building’s engineering and size did not necessarily translate into praise for its design. Those traveling to Utah in the late nineteenth century often were men and women of means and culture. They therefore were devoted to the reigning ideals of Victorian neo-Gothic architecture, with its detail and soaring mass. As a result, the Tabernacle’s unadorned practicality and nonconformity were upsetting, even offensive. Lady Mary McDowell Duffus Hardy, wife of Canada’s Governor-General, made no effort to restrain her scorn. “This far-famed structure strikes one as a huge monstrosity,” she wrote, “a tumour of bricks and mortar rising on the face of the earth. It is a perfectly plain egg-shaped building, studded with heavy entrance doors all around; there is not the slightest attempt at ornamentation of any kind; it is a mass of ugliness.”<sup>34</sup>

Lady Mary’s comment was part of a general chorus of complaint, as travelers tried to find the right words to express how deeply the Tabernacle’s eccentricity offended them. Accordingly, the building was dismissed as “rough-looking,” “destitute of beauty either in proportion or outline,” and “pure, unadulterated ugliness.”<sup>35</sup> The idea that President Young may have been religiously inspired to build the Tabernacle brought the rejoinder that the structure was not “the

---

<sup>30</sup>Samuel Phillips Day, *Life and Society in America* (London: Newman and Company, 1880), 244; William Wilson Ross, *10,000 Miles by Land and Sea* (Toronto, Canada: James Campbell & Son, 1876), 66–67.

<sup>31</sup>Nelson A. Miles, *Personal Recollections and Observations of General Nelson A. Miles* (Chicago: Werner Company, 1897), 368.

<sup>32</sup>Buss, *Wanderings in the West*, 160.

<sup>33</sup>Moore, “The Great Salt Lake and Mormonism,” 286.

<sup>34</sup>Mary McDowell Duffus Hardy, *Through Cities and Prairie Lands* (New York: R. Worthington, 1881), 120.

<sup>35</sup>The quotations come respectively from J. Aitkin, *From the Clyde to*

'stuff that dreams are made of.'"<sup>36</sup> In a similar vein, popular journalist and world traveler Maturin M. Ballou thought the structure had "no more architectural character . . . than . . . a prairie dog's hole,"<sup>37</sup> while Charles Marshall, writing for the influential *Frazer's Magazine*, was even more outspoken. Marshall believed that the building was "the most melancholy example of awkward architecture possible to [sic] the mind of man to conceive. . . . For my part, I decided that, so far as my experience goes, the oval tabernacle . . . is unsurpassed, even by its neighbouring preaching shanty [i.e., the Old Tabernacle] for oppressive ugliness among all the buildings now standing in the world."<sup>38</sup> In short, the building was a gigantic curio, something "strange" and "unique," to be talked or written about because of its outlandishness.<sup>39</sup> "We have never seen anything like it," said a British minister.<sup>40</sup>

The building was a frequent target for caricature. There were turtle images, which may have had their origin with Henry Grow and Apostle George A. Smith.<sup>41</sup> If so, visitors quickly picked up on the image and made it their own. There were many variations. The Taberna-

---

*California with Jottings by the Way* (Greenock, Scotland: William Johnson, 1882), 52; W. F. Rae, *Westward by Rail: The New Route to the East* (New York: D. Appleton & Company, 1871), 106; W. S. Turner, *Notes by a Wanderer from Demerara in the United States* (Demerara, [then British Guyana]: J. Thomson, 1885), 111.

<sup>36</sup>J. Allison, *Trans-Continental Letters, Written in Vacation* (Milwaukee, Wis.: Godfrey & Crandall's Steam Printing House, 1871), 3.

<sup>37</sup>Maturin M. Ballou, *Due West or Round the World in Ten Months* (Boston: Houghton, Mifflin, 1895), 6.

<sup>38</sup>Charles Marshall, "Salt Lake City and the Valley Settlement," *Frazer's Magazine* 83 (July 1871): 98.

<sup>39</sup>Elisha Butts, *An Epitomized History of the Life, Travels and Adventures of Elisha Butts* (Des Moines, Ia.: Kenyon Printing and Manufacturing, 1896), 102; Julian Street, "The Mormon Capital, American Ramblings, Observations and Adventures," *Collier's* 54 (November 28, 1914): 21; and Helena Maria Hunt Jackson, *Bits of Travel at Home* (Boston: Roberts Brothers, 1887), 19–20.

<sup>40</sup>Alfred Rowland, "Mormonism As It Is," *The Leisure Hour* 36 (1887): 37.

<sup>41</sup>Grow, "The New Tabernacle," *Salt Lake Daily Telegraph*, October 6, 1867, 2; Smith: Richard S. Van Wagoner and Steven C. Walker, *A Book of*

cle was “a squat brown turtle shell set hard upon countless red pillars”; “an immense turtle with its tail cut off”; “a huge land turtle standing motionless in its tracks”; “a prodigious tortoise that has lost its way, and is thinking which turn it shall take”; and “the Church of the Holy Turtle.”<sup>42</sup> Yet another popular image was the egg: “a prodigious egg-shell cut in two lengthwise”; “half of an eggshell set upon pillars”; “rounding up like a brown roc’s egg”; “the roof inside being what you would expect to see were you, yourself, an unhatched chicken”; “Gentiles say . . . [the Tabernacle] is a ‘bad egg.’”<sup>43</sup>

Or the Tabernacle might be compared to a culinary serving dish: “a Brobdingnag dish-cover”; “an enormous soup tureen wanting a handle”; “the cover of a chafing dish”; or a “large, oblong, bag pudding, placed upon a platter ready to be served to a goodly number of hungry harvest hands.”<sup>44</sup> Theodor Kirchhoff used a ponderous German image: “a giant butcher’s cauldron, overturned, after use by a Norse god of slaughter to carry a snack of a dozen roasted aurochs to

*Mormons* (Salt Lake City: Signature Books, 1982), 271.

<sup>42</sup>Respectively, Rollin Lynde Hartt, “The Mormons,” *Atlantic Monthly* 85 (February 1900): 262; Andrew Shiland, *From Ocean to Ocean: With Notes and Observations on the Way* (New York: American Tract Society, 1892), 6; Harvey Rice, *Letters from the Pacific Slope* (New York: D. Appleton & Company, 1870), 27–28; Henry W. Lucy, *East by West: A Journey in the Recess* (London: Richard Bentley and Son, 1885), 97; William G. Blaikie, *Summer Suns in the Far West* (New York: Thomas Nelson and Sons, 1890), 43.

<sup>43</sup>Respectively, Patrick Donan, *Utah: A Peep into a Mountain Walled Treasury of the Gods* (Buffalo, N.Y.: Matthews Northrup Co., 1891), 92; Frank G. Carpenter, *North America* (New York: American Book Company, [1898]), 286; Julian Ralph, “A Week with the Mormons,” *Harper’s Weekly*, April 8, 1893, 326; Theodora Grosvenor Guest, *A Round Trip in North America* (London: Edward Stanford, 1895), 81; and Benjamin F. Taylor, *Summer-Savory: Gleaned from Rural Nooks in Pleasant Weather* (Chicago: S. C. Griggs and Company, 1879), 20.

<sup>44</sup>Respectively, Hervey R. Jones, *To San Francisco and Back* (London: Society for Promoting Christian Knowledge, n.d.), 137, and Rae, *Westward by Rail*, 103; John Leng, *America in 1876* (Dundee, [Scotland]: Dundee Advertiser Office, 1877), 194; William Lawrence Humason, *From the Atlantic Surf to the Golden Gate* (Hartford, Conn.: Wm. C. Hutchings, 1869), 27; and Caroline M. Churchill, *Over the Purple Hills* (Denver: Mrs. C. M. Churchill, Publisher, 1884), 246.

Thor and Freye in Valhalla.”<sup>45</sup> Many Tabernacle images had to do with ships: an “inverted boat on a pedestal”; “a Dutch built craft, bottom up, no keel, and rounded stem and stern”; “Noah’s ark had it been capsized, and left high and dry on Ararat, keel upward”; and an “ocean liner turned upside down.”<sup>46</sup> Finally, other travelers likened the Tabernacle to balloons, bathtubs, bells, watermelons, a whale, and even mushrooms (“a huge blanc mange mold turned upside down and placed upon oblong pedestals”).<sup>47</sup> To be sure, many of these caricatures were offered in good fun, but the Mormons also understood that the humor often had an underlying malice, even prejudice.<sup>48</sup>

It was one thing to stand outside the Tabernacle and observe its oddity; it was another to enter its sanctum. It was here that visitors could better see that the Tabernacle did its tasks well. It was “admirably-arranged” and “useful,”<sup>49</sup> and it provided seats for the large Mormon congregation to see and hear.<sup>50</sup> The truss-built, arching ceiling allowed unobstructed views, at least until the completion of the gallery, which required supporting columns. It was here, too, that the vastness of the building was best seen, which to nineteenth-century eyes seemed almost overwhelming. Isabella Dinsmore, a Unitarian

---

<sup>45</sup>Frederic Trautmann, ed., “Salt Lake City Through a German’s Eyes: A Visit by Theodor Kirchhoff in 1867,” *Utah Historical Quarterly* 51, no. 1 (Winter 1983): 54–55.

<sup>46</sup>Respectively, Rose Lambart Price, *The Two Americas* (London: Sampson, Low, Marston, Searle, and Rivington, 1877), 259; H. Hussey Vivian, *Notes of a Tour in America* (London: Edwards Stanford, 1878), 107; Grace Greenwood, *New Life in New Lands: Notes of Travel* (New York: J. B. Ford and Company, 1873), 138; Trautmann, ed., “Salt Lake City through a German’s Eyes,” 54.

<sup>47</sup>Allison, *Trans-Continental Letters*, 3.

<sup>48</sup>Throughout this essay, I have drawn on the quotations compiled in Christine Edwards Allred’s unpublished essay, but never more so than in this listing of Tabernacle images. Allred, “A Huge and Hideous Edifice,” 11–16, unpublished manuscript, photocopy in my possession, used by permission.

<sup>49</sup>Charles Nordhoff, *California: For Health, Pleasure, and Residence* (New York: Harper & Brothers, Publishers, 1873), 41; William Morrison Bell, *Other Countries* (London: Chapman and Hall, 1872), 246.

<sup>50</sup>Shiland, *From Ocean to Ocean*, 6.

publicist, had “mingled feelings of solemnity, awe, and admiration” as she stepped into the expanse.<sup>51</sup> Other travelers commented on the “plain but smoothly plastered walls” and the building’s cool interior (“very welcome . . . after walking under the hot sun”).<sup>52</sup>

However, still others continued to look for Victorian warmth and richness and found none. “It is the dreariest of white-washed buildings inside,” said one Englishwoman. “Not even Henry Ward Beecher’s old Plymouth Church is more plain and bare,” said another traveler who was familiar with the famous preacher’s spiritual redoubt.<sup>53</sup> In fact, Lady Mary felt unsettled and perhaps a little alarmed by the Tabernacle’s interior. “The inside is vast, dreary, and strikes one with a chill,” she said. It was like “entering a vault.”<sup>54</sup>

For once, the travelers’ anti-Mormon bias had a basis in fact. Early photographs show a bare and gloomy interior, and the Mormons themselves described the building’s first days as ones of “rough lumber and scanty paint.”<sup>55</sup> This dark effect was compounded by the “astonishing number of plain pine seats” that filled the interior—a “battalion of pews,” said one observer.<sup>56</sup> These marched from one end of the building to the other, almost dizzying in repetitious and colorless magnitude. Further adding to the starkness, the building was seventeen years old before it received its first system of artificial lights. Until then, light entered from the panels of windows along the sides of the building, and then only if the sun’s position were right.<sup>57</sup> While the newly installed gas lights of the middle 1880s brightened the building, they were also “the source of much trouble in the matter

---

<sup>51</sup>Isabella Kimball Dinsmore, *Trips and Travel: Letters to the Unitarian Alliance* (Belfast, Maine: n. pub., 1929), 98.

<sup>52</sup>James Ross and George Gary, *From Wisconsin to California and Return* (Madison, Wis.: Atwood & Rublee, 1869), 30.

<sup>53</sup>Ethel Gwendoline Vincent, *Forty Thousand Miles over Land and Water* (London: Sampson Low, Marston, Searle & Rivington, 1886), 61; Julian Ralph, *Our Great West* (New York: Harper & Brothers, 1893), 397.

<sup>54</sup>Hardy, *Through Cities and Prairie Lands*, 120.

<sup>55</sup>“It Looks like New,” *Deseret Evening News*, September 28, 1895, 8.

<sup>56</sup>John Erastus Lester, *The Atlantic to the Pacific* (London: Longmans, Green, and Company, 1873), 46; Julian Ralph, “A Week with the Mormons,” *Harper’s Weekly*, April 8, 1893, 326.

<sup>57</sup>“Improvements in the Tabernacle,” *Deseret News Weekly*, April 9, 1884, 184.



of cleanliness.”<sup>58</sup> They had a tendency to discolor the walls.

The building’s functional doors, positioned around the oval of the building, brought more favorable comment, mainly because of their usefulness but also, perhaps, because their uniqueness was still another element in the Tabernacle’s eccentricity. “Twenty-two double doors afford ample means of ingress and egress,” said the Wisconsin excursionist, William Ross. “The time taken in getting out by a congregation of 6,000, on an ordinary occasion, was six seconds less than three minutes.”<sup>59</sup> Since this enthusiastic and perhaps untrue report was repeated by other travelers, the source may have been the voluble Charles J. Thomas, once conductor of the Tabernacle Choir, who also reigned as the building’s custodian and host from the Tabernacle’s dedication to the first decade of the twentieth-century.<sup>60</sup> According to visitors, the ability of a Mormon congregation to gather into the building was equally impressive. Because of the many, wide-ranging doors, it was as though the Tabernacle was “a huge sponge absorbing the population of the Territory.”<sup>61</sup> The system, of course, was a carry-over from the Bowery’s open air, multiple-access design, only with the promise of better temperature control.<sup>62</sup>

The gallery built in 1870 added further interest, but not enough to please the aesthetic taste of the demanding Lady Mary. The new gallery, she complained, was supported by rows of “thin, helpless-looking pillars,” which, when added to the “wide expanse of empty benches, dreary and depressing to the wandering eye,” left “no pleasant spot” to dwell upon.<sup>63</sup> Actually, the Tabernacle did have some decorative accouterments, although they could be overwhelmed by the general plainness of the interior. On the west end of the building was a multi-tiered, rising speaker’s stand. The lowest level was occupied by the bishops’ table, where officiators prepared and blessed the emblems of the Lord’s Supper. This long, narrow ta-

---

<sup>58</sup>“It Looks like New,” *Deseret Evening News*, September 28, 1895, 8.

<sup>59</sup>Ross, *10,000 Miles by Land and Sea*, 67.

<sup>60</sup>Preston Nibley, “Early Guide of Temple Square,” *Improvement Era* 66 (March 1963): 166–67, 202–5; Charles John Thomas, “Names of Visitors to the Tabernacle 1875–1917,” autograph book, LDS Church Archives.

<sup>61</sup>Ernest Ingersoll, “Salt Lake City,” *Harper’s New Monthly Magazine* 69 (June–November, 1884): 397.

<sup>62</sup>“The New Tabernacle,” *Journal History*, June 3, 1863, 1.

<sup>63</sup>Hardy, *Through Cities and Prairie Lands*, 120.

ble was flanked by two large covered barrels containing the sacramental water, "brought from the highest hills."<sup>64</sup> Behind it were seated the men who administered the sacrament, perhaps LDS Presiding Bishop Edward Hunter, with three bishops on each side.<sup>65</sup> For some years, the bishops' table was covered by a red cloth, which set off an array of silver-colored, electro-plate baskets and an equal number of double-handled goblets. These "gorgeous" silver cups were of all shapes and sizes, "as though prepared for an unlimited christening party or an everlasting service libation to some heathen deity rather than to a Christian God," said the jaundiced Lady Mary.<sup>66</sup> They may have had their origin with the first services of the Old Tabernacle when \$149 in silver coin and several pounds of "watch cases, spoons, rings, and other silver ornaments" had been collected from the congregation to secure apt tokens for the sacrament.<sup>67</sup>

Three tiers of seats rose behind the sacrament table, each by the middle 1870s having its own crimson-velvet altar or speaker's podium. These seating-tiers and altars probably had their origin in the assembly rooms of the LDS temples built in Kirtland, Ohio, and Nauvoo, Illinois. Whatever their origin, the Mormons seldom said much about them, perhaps because they took them for granted. In contrast, Utah's visitors were fascinated by them and explained their meaning as hierarchal. According to one traveler, only Brigham Young used the top pulpit (other travelers said that Young's counselors also spoke behind it); the second was the "common pulpit" used by LDS apostles and other speakers, while the third was often used for

---

<sup>64</sup>Caroline H. Dall, *My First Holiday: Or Letters Home from Colorado, Utah, and California* (Boston: Roberts Brothers, 1881), 95.

<sup>65</sup>Eugene Russell Hendrix, *Around the World* (Nashville, Tenn.: A. H. Redford, 1878), 30.

<sup>66</sup>Lady [Mary McDowell Duffus] Hardy, "The Tabernacle, Salt Lake City," in *Historic Buildings of America as Seen and Described by Famous Writers*, edited by Esther Singleton (New York: Dodd, Mead & Company, 1907), 218. Other travelers reported that a white cloth covered the sacramental table. See E[mily] Catherine Bates, *A Year in the Great Republic*, 2 vols. (London: Ward & Downey, 1887), 2:221; and R. C. W. Reveley Mitford, *Orient and Occident: A Journey East from Lahore to Liverpool* (London: W. H. Allen & Company, 1888), 276.

<sup>67</sup>"Seventh General Epistle of the Presidency of the Church of Jesus Christ of Latter-day Saints," 2:97.

prayers and announcements and by the presidency of the Salt Lake Stake.<sup>68</sup> Likely these uses varied over time. By the late 1880s, the highest pulpit displayed a Bible and a Book of Mormon and had a lion statuary on each side of the pulpit.<sup>69</sup> Lions were a popular LDS decorative motif that reminded the Saints of President Young's soubriquet: "Lion of the Lord."

The seating on the three tiers also reflected the LDS hierarchy. The highest was reserved for the Mormon prophet and probably for his counselors; the second was used by the Church's second tier of leaders, the apostles; and the third provided seats for Seventies, high priests, and perhaps for some of the bishops not at the sacrament table, an arrangement that was generally confirmed by the building plans drawn in the 1860s.<sup>70</sup> After visiting the Tabernacle, American naturalist Ernest Ingersoll said he believed the use of the pulpits and seating procedures were not "very rigidly observed," and he was probably right.<sup>71</sup> At least one traveler asked to be seated in the hierarchical stand, and the obliging Mormons, after briefly hesitating, granted his request.<sup>72</sup> Moreover, seats could be filled on the basis of punctuality, not seniority: "As the seats do not admit of persons passing those who are seated," it was explained, "the first entering will have their places in the center and so on till the seats are filled."<sup>73</sup>

During the 1870s, "a long straight bench and a small semicircular

<sup>68</sup>Ross, *10,000 Miles by Land and Sea*, 68; and *Salt Lake Daily Telegraph*, April 6, 1867, 1. Also see George Robert Bird, *Tenderfoot Days in Territorial Utah* (Boston: Gorham Press, 1918), 41-42.

<sup>69</sup>Mitford, *Orient and Occident*, 276. Charles William Carter, "Funeral of John Taylor," photograph, July 29, 1887, PH 1284, LDS Church Archives.

<sup>70</sup>Architect's Office, "Drawing of Tabernacle Interior," signed by Richard W. Young, CR 679-6, LDS Church Archives. Although the budding but talented Young drew the plans, Church architect Truman O. Angell was responsible for their conception and detail. According to Young's plans, rising above the "communion table" were a bishops' stand, a seventies' stand, a stake presidents' stand (at the time apostles often occupied this office), and the First Presidency's stand.

<sup>71</sup>Ingersoll, "Salt Lake City," 397.

<sup>72</sup>John H. Church, *Diary of a Trip through Mexico and California* (Pittsfield, Mass.: Marcus H. Rogers, Printer, 1887), 61.

<sup>73</sup>"The New Tabernacle," *Salt Lake Daily Telegraph*, October 6, 1867,

one" served as seats for the lower two levels.<sup>74</sup> In contrast, the highest level had a well-worn blue sofa, perhaps reserved for First Presidency counselors and some of the apostles as well.<sup>75</sup> Next to the sofa immediately to the south was the president's chair, which unlike the other Church leaders' seats eschewed the crimson velvet. This chair appears to have gone through several iterations, from a wooden hardback piece of furniture to a "large, decorated, and comfortable chair" that seemed to have a scepter of office extending from one armrest.<sup>76</sup> The seat was covered by an old buffalo hide, which one traveler claimed was a sign of Brigham Young's "stern simplicity" and an attempt on his part to recall the rigor of his pioneer journey to Utah. More likely, the practical Young simply found the buffalo hide comfortable.<sup>77</sup>

American missionary Eugene Vetromile, after scanning the interior of the Tabernacle and finding no "religious emblems," withdrew, apparently offended. An Irish Catholic nun, Mary Carroll, also complained that "this temple of fanaticism" had "no sign of religion," apparently another allusion to the Tabernacle's lack of traditional Protestant or Roman Catholic images.<sup>78</sup> However, if only a visitor had an eye to search them out, the Tabernacle was full of symbols and im-

---

<sup>74</sup>Mrs. Frank Leslie, *California: A Pleasure Trip from Gotham to the Golden Gate* (New York: G. W. Carleton & Co., 1877), 93.

<sup>75</sup>Hardy, "The Tabernacle, Salt Lake City," 218; Leslie, *California: A Pleasure Trip*, 93; and George W. Romspert, *The Western Echo: A Description of the Western States and Territories of the United States as Gathered in a Tour by Wagon* (Dayton, Ohio: United Brethren Publishing House, 1881), 332.

<sup>76</sup>Romspert, *The Western Echo*, 332. Several photographs captured both the chair and the scepter. See Charles Roscoe Savage, "Organ in Tabernacle," three photographs of different views, ca. 1895, PH 2184, PH 2185, PH 2186, LDS Church Archives; Harry Shipler, "Temple Square, Salt Lake City, Utah," photograph, ca. 1902, PH 887-1-4, LDS Church Archives.

<sup>77</sup>William Minturn, *Travels West* (London: Samuel Tinsley, 1877), 139. Also see Benjamin Robbins Curtis, *Dottings Round the Circle* (Boston: James R. Osgood and Company, 1876), 20–21; B. Davenport, *Under the Gridiron: A Summer in the United States and the Far West* (London: Tinsley Brothers, 1876), 71.

<sup>78</sup>Eugene Vetromil, *A Tour in Both Hemispheres: or, Travels Around the World* (New York: D. & J. Sadlier & Company, 1880), 73; Mary Teresa Austin Carroll, *Essays Educational and Historic or X-Rays on Some Important Episodes* (New York: O'Shea & Company, 1899), 259.

ages—some implicit and others expressly tangible. Indeed, the name of the building itself told a great deal. Rather than call their building a “church” or a “chapel,” the Mormons invoked the Old Testament Mosaic image of the Lord’s tabernacle in which the faithful might receive comfort and instruction in their spiritual wandering and where God’s word might be revealed.<sup>79</sup> It was God’s holy altar.<sup>80</sup> Continuing this metaphor, the expanse of Tabernacle benches, which democratically gathered the community of Saints without the pretense of reserved or rented pews and placed them before their leaders’ hierarchical pulpits and seats, especially the Prophet’s chair, captured many elements of the Mormon religious ideal. Mormonism, after all, was an unusual blend of democracy (social and economic equality) and theocracy (institutional authority).

There were explicit symbols, too, almost lost in the Tabernacle’s vastness. Several months before the building’s dedication in 1875, “an immense blue banner emblazoned with a golden beehive” was hung on the rear wall of the building. Beneath was the legend: “By Industry We Thrive.”<sup>81</sup> It had been placed on the east end of the Tabernacle by the Church’s “Deseret Sunday School Union” to remind children of one of Utah’s cardinal virtues. It would be by work, Church leaders understood, that many Utahns would be lifted from the lower and middle social ranks to which they had been born.

On the opposite end of the building above the tier of Church authority seats, other Mormon images were displayed. By the 1890s, a great star dominated this area, with pendants of flowing artificial flowers.<sup>82</sup> Lady Mary dismissed the decoration as “a monstrous Jack-in-the-green turned upside down,” but the star had signifi-

---

<sup>79</sup>To Israelites, the Tabernacle is “the central place of worship, the shrine that houses the ark of the covenant, and frequently it is the location of revelation. It is presented in biblical narrative as the visible sign of Yahweh’s presence among the people.” Richard Elliott Friedman, “Tabernacle,” *Anchor Bible Dictionary*, edited by David Noel Freedman, 6 vols. (New York: Doubleday, 1992), 6:292.

<sup>80</sup>Levi Edgar Young, *Conference Report*, April 1939, 72.

<sup>81</sup>Charles R. Savage, “Deseret Sunday School Union Pioneer Day Jubilee,” photograph, July 1875, PH 2197, LDS Church Archives. See also Hardy, *Through Cities and Prairie Lands*, 121; Leslie, *California: A Pleasure Trip*, 92; and Moore, “The Great Salt Lake and Mormondom,” 286.

<sup>82</sup>Leslie, *California: A Pleasure Trip*, 92.

cance.<sup>83</sup> It may have represented Jesus Christ as the “Evening and Morning Star,” the same millennial tidings that the Mormons had used to name one of their early newspapers, or, more likely, it was a patriotic reminder of Utah’s statehood, since the star in early photographs usually appeared with the word, “Utah.” By the end of the century, the star and “Utah” were electrically illuminated.<sup>84</sup>

For a time, the organ pipes at the west end of the building carried the words, “In God we put our trust” and “Under the everlasting covenant God must and shall be glorified.”<sup>85</sup> Timothy Coop and Henry Exley, tourists to Salt Lake City in the 1880s, listed other items:

On the left-hand side of the great organ is a large collection of sage-brush, with small sun-flowers, and one small pine tree, and on a large calico strip, the figures 1847. This symbolizes that when the Mormons came to Utah, in that year, they found not a single blade of grass in the region; nothing but sagebrush, sunflowers and pine trees. On the right-hand side of the organ were sage-brush, sunflowers and every variety of flowers, to indicate that they had made the wilderness to blossom as the rose; and amongst them all, in great figures, 1880.<sup>86</sup>

These decorations had been placed in the Tabernacle to mark the Church’s fiftieth anniversary, and they celebrated Mormon pioneering, although perhaps not with Coop and Exley’s version of Utah’s natural, pre-Mormon environment. The Mormons in fact had chosen their “promised land” partly because of its rich, native grasses.

The Mormons used the Tabernacle repeatedly to express their patriotism. It was a point that the Saints, often accused of disloyalty to the United States, made repeatedly and with emphasis. An American

---

<sup>83</sup>Hardy, *Through Cities and Prairie Lands*, 121.

<sup>84</sup>Unidentified photographer, “Karl G. Maeser Funeral,” February 19, 1901, PH 876, LDS Church Archives; Johnson Photography Studio, “Wilford Woodruff’s Funeral Casket in the Tabernacle,” ca. 1897, PH 215; Unidentified photographer, “Views of the Temple, Annex(es), Tabernacle, and Other Buildings on the Square,” photograph, ca. 1900, PH 362; and Charles Owens, “Views of the Interior of the Salt Lake Tabernacle,” ca. 1905, PH 433, LDS Church Archives.

<sup>85</sup>Mitford, *Orient and Occident*, 276.

<sup>86</sup>Timothy Coop and Henry Exley, *A Trip around the World* (Cincinnati, Ohio: H. C. Hall & Company, 1882), 20.

flag flew from a “lofty” pole on top of the building.<sup>87</sup> Flags frequently decorated the interior as part of Pioneer Day and Independence Day celebrations, and these banners in turn were augmented by many smaller red, white, and blue flags and by extensive bunting. Once in place, these patriotic symbols were allowed to remain for months or even years after the festivals had been concluded.<sup>88</sup> More permanent was the American flag that usually was draped on the console of the organ, “to prove,” said British traveler John Mortimer Murphy “that the Mormons are a loyal people.”<sup>89</sup>

The largest American flag ever displayed in the Tabernacle was prepared in the ZCMI overall factory and exhibited in 1896 as part of Utah’s statehood celebration. This huge banner, said to be one of the largest American flags ever made, was 75 by 160 feet and was laid out on the Tabernacle’s benches before being attached to the ceiling. The space designating Utah’s “forty-fiftieth” star was cut from the banner to allow the placement of an electrically lighted star. Workers completed the effect by placing an American eagle over the organ pipes. During the ceremony, a thousand children waved small flags.<sup>90</sup>

During the nineteenth century, the Tabernacle also displayed several illustrations, perhaps in the rear of the building. These included several historical murals, one of which showed Joseph Smith receiving the Book of Mormon golden plates. After the turn of the century, the Mormons also hung a portrait of Smith, several times larger than life, between the Tabernacle organ’s biggest pipes. This

---

<sup>87</sup>Ross and Gary, *From Wisconsin to California and Return*, 30; William Robertson and W. F. Robertson, *Our American Tour: Being a Run of Ten Thousand Miles from the Atlantic to the Golden Gate in the Autumn of 1869* (Edinburgh: W. Burness, 1871), 73.

<sup>88</sup>Moore, “The Great Salt Lake and Mormondom,” 287; Fanny L. Rains, *By Land and Ocean* (London: Sampson Low, Marston, Searle, & Rivington, 1878), 227; and S. M. Lee, *Glimpses of Mexico and California* (Boston: Geo. H. Ellis, Printer, 1887), 110.

<sup>89</sup>John Mortimer Murphy, *Rambles in North-Western America: From the Pacific Ocean to the Rocky Mountains* (London: Chapman and Hall, 1879), 247.

<sup>90</sup>Robert C. Mitchell, “Desert Tortoise: The Mormon Tabernacle on Temple Square,” *Utah Historical Quarterly* 35, no. 4 (Fall 1967): 287; Linda Sillitoe, *A History of Salt Lake County* (Salt Lake City: Utah State Historical Society, 1996), 12.



*The Tabernacle stand draped in white for the funeral of Karl G. Maeser, February 19, 1901. The General Authorities are seated on the stand, and the portrait in the center is of Maeser. The object resembling a small plush-topped table in the center aisle is probably a radiator. Flambeau-style torches appear above the drapery at the foot of the organ. The star and "Utah" in electric lights had been put there in time for the celebration of Utah's admission to the Union in January 1896. Photographer unknown. Courtesy LDS Church Archives (PH876-1).*



portrait was set off by a festoon of white cloth. Inscriptions above and below the painting read: "Peace on earth good will to men" and "The glory of God is intelligence." Both were illuminated by electric lights.<sup>91</sup>

The Mormons, in fact, were fond of didacticism: The Tabernacle was a place where values were to be taught. Starting as early as 1868, the thirty-six spandrels above the arches supporting the galleries contained homilies, "partly Scriptural, partly political, and partly simply practical," which conveyed the values of the Mormon settlement.<sup>92</sup> One edition of these mottoes had nine that had to do with children or parenting; another nine urged reverence for Church leaders and Church authority; and a half dozen others suggested other ways that Mormon society could be built and refined:

OBEDIENCE IS BETTER THAN SACRIFICE. SUFFER LITTLE CHILDREN TO COME UNTO ME. WE THANK THEE, O GOD, FOR A PROPHET. KEEP YOUR ARMOR BRIGHT. GOD BLESS OUR TEACHERS. BE TEMPERATE IN ALL THINGS. IF YE LOVE ME, DO MY WILL. HOLINESS TO THE LORD. WHAT HATH GOD WROUGHT. OUR OWN MOUNTAIN HOME. UNITED WE STAND, DIVIDED WE FALL. HEIRS OF THE PRIESTHOOD. FEED MY LAMBS. DO WHAT IS RIGHT. OUR CRUCIFIED SAVIOR. THE MOTHERS IN ISRAEL. UNION IS STRENGTH. KNOWLEDGE IS POWER. THE DAUGHTERS OF ZION. OUR MARTYRED PROPHET. GOD AND OUR RIGHT. ZION IS GROWING. IN GOD WE TRUST. OUR LIVING ORACLES. THE KINGDOM IS OURS. THE HOLY PRIESTHOOD. UTAH'S BEST-CROP CHILDREN. BRIGHAM OUR LEADER AND FRIEND. HAIL TO OUR CHIEFTAIN. PROVIDENCE IS OVER ALL. CHILDREN, OBEY YOUR PARENTS. PRAISE THE LORD—HALLELUJAH! HONOR THY FATHER AND MOTHER. THE KINGDOM OF GOD

<sup>91</sup>Unidentified photographer, "Salt Lake Tabernacle Interior Draped and Decorated for the Joseph Smith Memorial Service," in Joseph Smith Memorial Dedication Trip," ca. 1905, PH 91-8-2, LDS Church Archives.

<sup>92</sup>"Celebration of the 4th July," *Deseret News*, July 6, 1868, 2; Curtis, *Dottings Round the Circle*, 21. For descriptions of these inscriptions, see also Davenport, *Under the Gridiron*, 72; Fredrick E. Shearer, ed., *The Pacific Tourist* (New York: Adams and Bishop, 1889), 149; and George F. Pierce, *Life and Times of George F. Pierce* (Nashville, Tenn.: Huhjter and Welburn, 1888), 592-93.

OR NOTHING. GLORY TO GOD IN THE HIGHEST. THE PIONEERS OF 1847.<sup>93</sup>

Perhaps the most curious of all the Tabernacle furnishings occupied the center of the main floor, about a dozen or so benches from the west-end rostrum. This was a white ornamental fountain that rose several feet above the adjoining benches and may have been twenty feet long on each side. From its base, which originally had live water lilies, the fountain lifted in a series of levels, each with a wave-like pattern. A “grateful spray” issued from its top.<sup>94</sup> Four large statuary lions, *en couchant*, were positioned at the corners of the ornamentation.<sup>95</sup> Non-Mormons did not know what to make of it. Seeking a religious explanation, Edwards Roberts thought it might serve as a baptismal font. Another visitor noted the fountain’s “flow of iced water” and believed it offered refreshment, even though large casks of water stood throughout the building for this very purpose. Or was it an attempt to cool the Tabernacle’s air? The fountain was unusual enough for one traveler to remove one of the granite stones from its base as a souvenir—a “gift from the temple,” he said.<sup>96</sup>

For the Mormons, the fountain was no mystery: it was a representation of the “living water” offered by Christ and his gospel. It had been placed in the Tabernacle in 1875 during one of the Mormons’ grand youth “jubilees.” At that time, four children sat at each corner of the fountain, dressed in costumes representing “the four quarters of the globe, Europe, Asia, Africa, and America,” two of which were

<sup>93</sup>Curtis, *Dollings Round the Circle*, 21–22.

<sup>94</sup>“The Jubilee,” *Deseret Evening News*, July 26, 1875, 3.

<sup>95</sup>Charles R. Savage, “Deseret Sunday School Union Pioneer Day Jubilee,” photographs, July 1875, PH 219 and PH 2578, LDS Church Archives; unidentified photographer, “Salt Lake Tabernacle Interior Draped and Decorated for the Joseph Smith Memorial Service,” in Joseph Smith Memorial Dedication Trip Collection, ca. 1905, PH 91-8-2; Johnson Photography Studio, “Tabernacle,” 1898-1902, PH-215, LDS Church Archives.

<sup>96</sup>Crouching lions: Hardy, *Through Cities and Prairie Lands*, 120; baptisms: Edwards Roberts, “A Glimpse of Utah,” *Overland Monthly* 5 (January 1885): 41; drinking water: James Aitken, *A Run through the States* (Greenock, Scotland: Greenock Herald Office, 1882), 52; water casks: Frederick J. Falding, *Notes of a Journey Round the World* (Sheffield, Eng.: Leader and Sons Printers, 1876), 202; and souvenir: Lanson Boyer, *From the Orient to the Occident* (New York: E. Wells Sackett & Bros., 1878), 62.

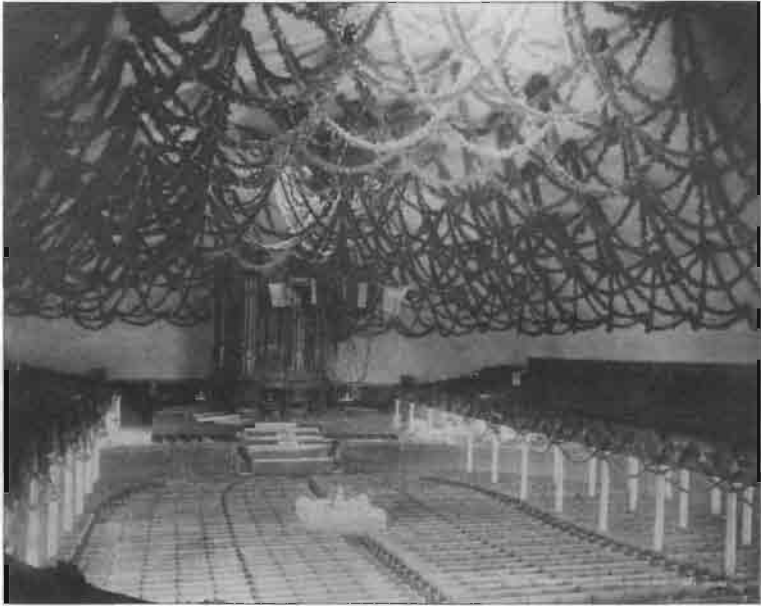

*The Tabernacle interior, its ceiling festooned with garlands in honor of an unspecified "Jubilee," ca. 1882. The white square structure in the center is a fountain which played streams of water on all four sides. Photograph by Charles Roscoe Savage, courtesy LDS Church Archives (PH217-2).*

described as "genuine specimens"—apparently Black and Native American children.<sup>97</sup> To complete the ensemble, a statuesque "Goddess of Liberty" also appeared. In her right hand, she held an American flag which she waved each time the youthful congregation sang the chorus to the hymn "Standard of Zion." In her left hand was the "Sword of State," a representation of the hope of peace.<sup>98</sup>

The 1875 jubilee also had a motif that would become familiar to twentieth-century Mormon temples. Above the organ, Mormons placed a "gilded and shaded figure" of a heavenly messenger, sounding the gospel trumpet to "every kindred, tongue and people."<sup>99</sup> It was, of course, the Angel Moroni. Nor was this all. According to one

<sup>97</sup>"The Jubilee," *Deseret News*, July 26, 1875, 3.

<sup>98</sup>*Ibid.*, 408–9.

<sup>99</sup>"The Jubilee," 3.

estimate, 750,000 artificial flowers and roses had been strung on three miles of cord for the event.<sup>100</sup> In addition, large centerpiece trees were hung from the ceiling and festoons of evergreens crisscrossed the roof and gallery. With 12,000 Sunday School children in the audience, Apostle Wilford Woodruff described the scene as “the grandest sight I Ever saw in my life.” Another observer called the pagant “simply magnificent.”<sup>101</sup>

Such elaborate festivals were not uncommon, for Church leaders saw the value of using the Tabernacle to instruct and inspire Mormon youth. And once the resplendent decorations were in place, they might remain on display long after the event—far too long, according to some fastidious visitors. These critics spoke of “faded evergreen wreaths and tawdry flags,” “old and withered” garlands, and shopworn Christmas wreaths and evergreens. “B. E. E.,” the author of *Wanderings in Distant Lands*, complained that one chandelier of “withered evergreens” bore the “dust of seven years.”<sup>102</sup> Cedar garlands and perhaps inverted trees were a part of the Tabernacle for a decade or more.

Why did the Mormons put up with their fading decorations for so long? Perhaps they were aware that their cavernous hall needed embellishment. Or perhaps it was a matter of acoustics. Soon after the building was finished, Truman Angell moved to different points of the interior to test its qualities. “The bustle and noise made by the people destroyed the words of the speaker or drowned them,” he observed.<sup>103</sup> The noise levels were especially bad in the center of the building near the speaker’s stand.<sup>104</sup>

The Tabernacle’s rounded surfaces were too sensitive to sound and produced disturbing echoes. “The other day,” reported journalist and essayist Grace Greenwood, “when one of the Mormon preachers . . . waxed bold and passionate, a clear, emphatic echo to each word seemed to come from somewhere away down be-

<sup>100</sup>Woodruff, Diary, July 24, 1875.

<sup>101</sup>Ibid.; “The Jubilee,” *Deseret News*, July 26, 1875, 3.

<sup>102</sup>Vincent, *Forty Thousand Miles over Land and Water*, 62; Lucy, *East by West*, 98; S. H. Jones-Parry, *My Journey Round the World* (London: Hurst and Blackett, 1881), 206; B. E. E., *Wanderings in Distant Lands* (England: n. pub., 1884), 20.

<sup>103</sup>Angell, Diary, October 6–7, 1867; also quoted in Grow, *A Tabernacle in the Desert*, 86–87.

<sup>104</sup>“Quiet in the Tabernacle,” *Deseret Evening News*, April 3, 1884, 2.



*The Tabernacle interior from the stand, facing east. It is decorated for the Deseret Sunday School Jubilee in 1875. Note the garlands and swags across the ceiling and along the bottom of the balcony, and the four-sided fountain in the center of the main floor. Photograph by Charles Roscoe Savage. Courtesy LDS Church Archives (PH217-1).*

low." It was as though "two distinct services" were being held "in full blast." Even Brigham Young admitted the trouble. "Every sound rings so much through the building that at some points it is a little difficult to distinguish what is said."<sup>105</sup>

In contrast, others found the building's acoustical qualities excellent. Visitors were amazed at how clearly they could hear when seated at the rear of the empty Tabernacle. Perhaps tourist guides might drop a pin or speak in a soft voice. After observing such a test, newspaperman Julian Ralph concluded "the only trick was in the building,"<sup>106</sup> and for once the Tabernacle triumphed over its Victorian rivals. "Its acoustic properties, unlike too many of our modern Gothic abominations, are excellent," said W. S. Turner, who voiced the refrain of many visitors. "Its acoustic properties are said to be the most perfect and wonderful of any building in the world," said another.<sup>107</sup>

When the famed operatic soprano Adelina Patti sang in the building in 1884, the Tabernacle performed remarkably. "The softest, sweetest strains of 'Home, Sweet Home' were distinctly heard in every part of the Tabernacle," wrote a *Deseret News* reporter. According to Patti's manager, Patti and the other singers "found it so easy to pour out their liquid melody, that they were afraid to give voice to their strongest notes lest the echoes should be found too powerful." Here was a lesson. "If the same quiet which prevailed at the Pattie [sic] concert were preserved in a Conference congregation," the newspaper editorialized, "we believe that most of the speakers would be distinctly heard in every part of the Tabernacle." During Church meetings, the Saints should "keep quiet" and preserve "perfect order," especially restraining children who "too often moved about the building without restraint."<sup>108</sup>

In short, the building's ability to reproduce sound was too good. "That which makes it good makes it bad," reported T. S. Hudson. "For every cough and rustling of dress is as distinctly heard as

---

<sup>105</sup>Greenwood [pseud. of Sarah Jane Clark], *New Life in New Lands*, 143; Brigham Young, Letter to George Nebeker, November 8, 1867, Brigham Young Letterbooks, LDS Church Archives.

<sup>106</sup>Ralph, *Our Great West*, 397-98.

<sup>107</sup>Turner, *Notes by a Wanderer*, 111; Butts, *An Epitomized History*, 110; Coop and Exley, *A Trip around the World*, 17.

<sup>108</sup>"Quiet in the Tabernacle," *Deseret Evening News*, April 3, 1884, 2.

the preacher's voice," which created a problem because many Mormons had the reputation for coming to meeting late, leaving early, and talking to neighbors or allowing their children to cry during a service.<sup>109</sup> However, the echoes were dampened by the gallery, which had a "wonderful effect."<sup>110</sup> Another factor was the musty and deteriorating evergreens, which explained their prominence and longevity. They "conquered the echo," said Alfred Rowland, "and the festoons still hang there, faded, but victorious."<sup>111</sup>

One of the building's most important fixtures was the great organ. Once the construction of the Tabernacle had begun, Brigham Young sought the help of Joseph Ridges, an English-born convert, who had built the Old Tabernacle's organ.<sup>112</sup> "Can we do this thing," Ridges remembered Young asking, who then answered his own question. "Yes, we can. . . . We can do anything we put our mind to." The task was Herculean. Huge quantities of glue were produced in on-site boiling vats, using local hides. Also necessary was a special, knot-free wood for the larger pipes, hauled from distant Pine Valley in southern Utah. Gears, keyboard pieces, and other mechanical parts were purchased in the East. Completing the instrument took almost ten years and an estimated \$70,000, an enormous sum for the time. Young pronounced it a "handsome specimen of art" and a "masterpiece."<sup>113</sup> It showed, of course, the

<sup>109</sup>*Deseret Evening News*, November 17, 1868, 2; Angell, *Diary*, October 7, 1867; Evan Stephens, "The Choir Returns," *Deseret Evening News*, September 13, 1893, 1.

<sup>110</sup>Brigham Young, Letter to Joseph W. Young, May 10, 1870, Brigham Young Letterbooks, LDS Church Archives.

<sup>111</sup>Rowland, "Mormonism As It Is," 37.

<sup>112</sup>George E. Carpenter, "Men Who Have Done Things: Joseph H. Ridges, the Man Who Built the Tabernacle Organ," *Western Monthly* 12, no. 3 (March 1911): 36–37.

<sup>113</sup>Young seeking Ridges's help: Brigham Young, Letter to Joseph Ridges, November 15, 1858, Brigham Young Letterbooks, LDS Church Archives; Ridges's memories of construction: G. Carpenter, "Men Who Have Done Things," 37–39; Pine Valley lumber: Brigham Young to W. S. Warren, June 1, 1863, Brigham Young Letterbooks; Eastern goods: Brigham Young, Letter to Feramor Little, June 5, 1863, Brigham Young Letterbooks; Tabernacle cost: Brigham Young, Letter to Frank Low, May 4, 1872, Brigham

importance that the Mormons put on devotional music.<sup>114</sup>

The organ was one feature of the Tabernacle—and Mormonism—that visitors praised. Its size alone compelled respect. “It is fifty-eight feet high, has fifty-seven stops, and contains two thousand six hundred and forty-eight pipes, some of them nearly as large as the chimneys of a Mississippi River steamboat,” claimed one author.<sup>115</sup> When first played, it was one of the half dozen largest organs in the world and perhaps the largest U.S.-built organ.<sup>116</sup> Other visitors were charmed by its “gilded pipes” and “massive pilasters of carved black walnut,” which made it “the only ornate object in the tabernacle.”<sup>117</sup>

At first the Tabernacle organ was powered by four men working bellows. Later, the power source was a water mechanism, which could be unreliable. Lady Theodora Grosvenor Guest remembered hearing only part of one projected recital: “The organist . . . stepped up to the organ and played very beautifully, but not long, for the organ suddenly ‘went out.’ So we went down, and were introduced and thanked him for what he had done; and he explained that the organ is blown by water-power, and that just now the people use so much for sprinkling their lawns and gardens, that the supply often falls short.”<sup>118</sup>

Ultimately it was not the great organ’s size, display, workmanship, or mechanics that won its reputation. Its success came from its sound, which softened even the jaundiced visitor. “Notwithstanding its immense size,” wrote one usually sharp-tongued observer, “it has not a single harsh or metallic sound; on the contrary, it is marvelously

Young Letterbooks; labor: Mitchell, “Deseret Tortoise,” 288–89; “Art and masterpiece”: Brigham Young, Letter to Albert Carrington, September 4, 1869, Brigham Young Letterbooks.

<sup>114</sup>J. Spencer Cornwall, *A Century of Singing: The Salt Lake Mormon Tabernacle Choir* (Salt Lake City: Deseret Book, 1958), 25.

<sup>115</sup>Donan, *Utah*, 92.

<sup>116</sup>D. Appleton, *Appleton’s Handbook of American Travel: Western Tour* (New York: D. Appleton & Co., 1872), 110; Nicholas Ball, *The Pioneers of ’49* . . . (Boston: Lee and Shepard Publishers, 1891), 214.

<sup>117</sup>J. W. Miller, *The Cincinnati Excursion to California* (Cincinnati, Ohio: Published for the Indianapolis, Cincinnati & Lafayette R. R., 1870), 34.

<sup>118</sup>Lady Theodora [Grosvenor] Guest, *A Round Trip in North America* (London: Edward Stanford, 1895), 82. For the organ’s hand power: Rains, *By Land and Ocean*, 227.



soft-toned; from the low flute-like wailing voice of the *vox humana* to the deep bass roll which stirs the air like a wave of melodious thunder, it has all the delicacy of the Aeolian harp, with the strength and power of its thousand brazen voices."<sup>119</sup>

The music of the great organ seemed ethereal, metaphysical. It sang of "faraway things you never thought anyone but yourself knew, the very secrets of your soul," said James B. Pond, booking agent for Ann Eliza Webb's anti-Mormon lectures and later a premier lecture agent on the national scene.<sup>120</sup> Harvey Rice, an educator and historian from the Western Reserve, described its tones as "heavy as the muttering thunders and yet as sweet as the music of the spheres," while Victorian poet and feminist Emily Pfeiffer thought that the instrument revealed the Mormon soul. Its strains were "mysterious" and "incommunicable," "sudden" and "almost overpowering." The great organ voice wailed "with all the tribulation and sorrow of this hunted community."<sup>121</sup>

The organ was enhanced by singing. Sometimes this meant the voices of the congregation, many thousands united "all in unison and perfectly good tune," which produced an "exceedingly grand" effect.<sup>122</sup> More often, travelers commented on the Tabernacle Choir, which again received the earnest support of Brigham Young. "I have a mission for you," he told one of the men chosen to lead the choir. "I want you to take the Tabernacle Choir . . . and lay a foundation for good music."<sup>123</sup> During the Tabernacle's first years, the choir's size for a Sunday service may have been around seventy-five voices, most of them women's. However, by 1883 the choir was large enough to justify the expansion of the loft to hold 200 singers. By the end of the century, the choir might swell to 350 and even 500 singers for a ses-

<sup>119</sup>Hardy, "The Tabernacle, Salt Lake City," 218.

<sup>120</sup>James B. Pond Papers, William L. Clements Library, University of Michigan, retrieved in September 2003 from [www.clements.umich.edu/Webguides/NP/Pond.html](http://www.clements.umich.edu/Webguides/NP/Pond.html).

<sup>121</sup>James B. Pond, "In the Homes of the Mormons," *Travel*, June 1915, 22; Rice, *Letters from the Pacific Slope*, 28; and Pfeiffer, *Flying Leaves from East and West*, 2d. ed. (London: Field and Tuer, 1885), 163.

<sup>122</sup>Winefred Howard, *Journal of a Tour in the United States, Canada and Mexico* (London: Sampson Low, Marston & Company, 1897), 59.

<sup>123</sup>Quoted in Cornwall, *A Century of Singing*, 352.

sion of the Church's general conference.<sup>124</sup>

"I never heard such enchanting music. It seemed grand and inspiring beyond power to express," said Andrew Shiland, a Presbyterian Church excursionist, after hearing the choir's rendition of Handel's Hallelujah Chorus.<sup>125</sup> George Romspert, another denominational tourist, thought that he had never heard "sweeter music," while Major William Bell of the British Army liked the "general and powerful harmony" that was "unequaled" in his experience of enjoying church music.<sup>126</sup> It was not just the technical excellence of the choir that was so appealing. Mormon music had emotion. "It has a prairie weirdness about it which mellows your feelings rather than excites them," said William Myers, a Lutheran minister and popular writer. Others described Mormon singing as "heavy" or "slow and drawling like Methodists or Presbyterians." If James Cox's observation was correct, the Mormon singers particularly liked the minor keys; and as a result, "a strain of plaintiveness mingles with all its majesty and power." Lady Winefred Howard of Glossop, England, thought that Mormon singing seemed "a little in the [sentimental] 'Salvation style,'" and she was probably right.<sup>127</sup>

Yet even the Tabernacle Choir and its music could not escape censure. Travelers found it difficult to separate Mormon music from their settled conviction about Mormonism. Thus, John S. Spaulding thought that while the Tabernacle's music was "ren-

<sup>124</sup>Size of the choir and women: Rowland, "Mormonism As It is," 94; enough singers: Cornwall, *A Century of Singing*, 257; loft expansion: "The Tabernacle," *Deseret Evening News*, September 29, 1883, E-5; voices at conference: Cornwall, *A Century of Singing*, 161; Dinsmore, *Trips and Travel*, 103; and Shiland, *From Ocean to Ocean*, 5.

<sup>125</sup>Shiland, *From Ocean to Ocean*, 5.

<sup>126</sup>Romspert, *The Western Echo*, 332; and Bell, *Other Countries*, 247. Also see William H. Myers, *Through Wonderland to Alaska* (Reading: Eng. Reading Times Print, 1895), 180-81.

<sup>127</sup>Peculiar: Myers, *Through Wonderland to Alaska*, 180-81; heavy: J. M. Peebles, *Around the World* (Boston: Colby and Rich, 1875), 8; slow: Russell J. Colman, Letter to Mother, August 26, 1885, in Russell James Colman, *Trifles from a Tourist* (Norwich [Eng.]: Fletcher and Son, 1887), 36; drawling: Bates, *A Year in the Great Republic*, 220; plaintive: James Cox, *My Native Land* (St. Louis: Blair Publishing Company, 1895), 98; and salvational: Howard, *Journal of a Tour*, 59.

dered with skill and pathos," still, it was a "cruel mockery." Such music should have been reserved for "a more exalted and sacred purpose." William Ross admitted that the choir lifted him "into a higher life," despite flowing from a "dread delusion." However, no traveler struggled with more ambivalence than Elisha Butt, who, writing published letters to his daughter, frankly admitted the allure of the Tabernacle Choir's sacrilege: "The attention was still fixed on the great organ and that wondrous choir, and in spite of a prejudice [against Mormonism] the seeds of which were sown in early boyhood, so grand, so magnificent, so superior [was the Mormon music] to any else of its kind I had ever heard before was it, that I admire, I praise, I do them homage even had they sang praises to Satan himself."<sup>128</sup>

Mormon music was only one element of Tabernacle worship, which was community worship. Each Sunday every Saint in the city was invited to "go to meeting" on Temple Square. Although perhaps fewer than one in seven or eight visited the Tabernacle on a particular Sunday (bad weather made percentages worse), the practice expressed the Mormon hope for unity and togetherness. There was a general pattern: The morning two-hour service was occupied by only one or two speakers, perhaps Church leaders. The afternoon meetings often had briefer sermons delivered by men in the congregation, who might volunteer or be called upon to speak. Whether in the morning or afternoon, speakers were expected to follow the scriptural ideal by taking no forethought for their remarks but to speak by the Holy Spirit's prompting (Matt. 10:19; Mark 13:11). In practice, this meant that speakers avoided prepared texts, dialogued with the congregation, issued reproof and correction, and even amused the Saints with stories and good humor. The atmosphere was informal (one traveler said the congregation might react with "giggles, nods, winks, itchings, and shuffling feet"<sup>129</sup>) and democratic. The Mormons did not have rented pews and places reserved for the well-to-do, "all people being served alike, the banker and day laborer seating themselves

---

<sup>128</sup>Ross, *10,000 Miles by Land and Sea*, 69; John A. Spaulding, *From New England to the Pacific* (Hartford, Conn.: Press of the Case, Lockwood & Brainard Company, 1884), 182–83; Butts, *An Epitomized History*, 113.

<sup>129</sup>Ross, *10,000 Miles by Land and Sea*, 70.

side by side.”<sup>130</sup> Each service ended as it began—with a prayer and a hymn, usually sung by the choir. The Saints then quickly moved to the doors and fresh air, crowding the nearby streets like evening “showtime” in other U.S. cities.<sup>131</sup>

Zion’s tourists, many wealthy and used to formal ritual, were unimpressed. They saw Mormon worship as disappointingly simple and commonplace, perhaps like the meetings of the Campbellites, Presbyterians, or Methodists of an earlier generation.<sup>132</sup> English visitors labeled Mormon services as Non-Conformist.<sup>133</sup> Many were put off by the style of LDS preaching. For instance, New York *Tribune* editor Horace Greeley protested that “this mortal life is too short and precious to be wasted in listening to rambling, loose-jointed harangues.” Greeley recommended that Mormon speeches be “boiled down and clarified” to a half an hour each.<sup>134</sup> Yet another visitor thought Mormon preaching was “speech gone to seed”; Tabernacle preachers gave only “husks of the harvest” and words without much meaning.<sup>135</sup>

Others complained about the range of Mormon topics. Tabernacle sermons might include advice on “the best manure for cabbages, the perseverance of the Saints, the wickedness of skimming milk before its sale, on bedbug poison, teething in children, worms in dried peaches, and any possible thing which can be imagined.” World traveler Margaretha Weppner called Mormon preaching a “grotesque *pot-pouri* [sic] of religion, . . . a most indigestible dish.”<sup>136</sup> While such comments overstated Tabernacle reality, Brigham Young affirmed their general truth: “Moses took the Children of Israel out

<sup>130</sup>Dinsmore, *Trips and Travel*, 97.

<sup>131</sup>Bird, *Tenderfoot Days in Territorial Utah*, 44.

<sup>132</sup>Samuel Bowles, *Across the Continent: A Summer’s Journey to the Rocky Mountains, the Mormons, and the Pacific States, with Speaker Colfax* (Springfield, Mass.: Samuel Bowles & Company, 1866), 117–18; Boyer, *From the Orient to the Occident*, 64; Aitken, *From the Clyde to California*, 53–54.

<sup>133</sup>Daniel Pidgeon, *An Engineer’s Holiday* (London: K. Paul, Trench, and Company, 1882), 248.

<sup>134</sup>Horace Greeley, *An Overland Journey: From New York to San Francisco* (New York: C. M. Saxton, Barker & Co., 1860), 220.

<sup>135</sup>Bird, *Tenderfoot Days in Territorial Utah*, 43.

<sup>136</sup>R. Spice, *The Wanderings of the Hermit of Westminster: Between New York and San Francisco* (London: Metchim and Son, 1882), 22–23;

of Egypt into the wilderness and there taught them the principles of there Every day life. It is so with the Saints Here.”<sup>137</sup> Young’s Zion (and Tabernacle preaching) was practical, down-to-earth, here-and-now.

Another item of complaint was Mormon exclusiveness—claims that the Mormon religion was the “only true Church” and that the Saints were “God’s peculiar, chosen, beloved people.” Such a scheme put the rest of mankind “out of the ark of safety and floundering in heathen darkness.”<sup>138</sup> After one visitor heard such remarks, she decided to leave the Tabernacle immediately, having personal chagrin added to her outrage. “When . . . [the preacher] said ‘God and his angels are with us, and only the devil and those who are influenced by the devil are against us,’ we thought it about time to leave, especially as we had been twice taken for Mormons by strangers who sat behind us.”<sup>139</sup>

For many years, the Mormon congregation was divided by gender. “The men come into this [Old] Tabernacle at one end door, and the women at the other,” Hannah Clapp, on her way to a distinguished career as a Nevada educator, explained in 1859.<sup>140</sup> The reason was simple: The Mormons did not want their women mixing with Gentiles, especially with U.S. soldiers who had arrived in the territory after the Utah War. Church leaders therefore ran a barrier through the center of the Old Tabernacle and put the women on the north side and the men on the south.<sup>141</sup> The practice continued after the Tabernacle was built. “The men and women were mostly but not strictly separated,” reported Salt Lake resident R. A. N. Harvey. At first the women were assigned the seats directly in front of the podium, while the gentlemen occupied the side seats. While the arrangement was later changed, gender seating revealed an interesting fact: two-thirds

---

Margaretha Weppner, *The North Star and the Southern Cross*, 2 vols. (London: Sampson Low, Marston Low, and Searle, 1876), 1:135.

<sup>137</sup>Quoted in Woodruff, Diary, June 8, 1862.

<sup>138</sup>Greeley, *An Overland Journey*, 220.

<sup>139</sup>Ellen G. Hodges, *Surprise Land: A Girl’s Letters from the West* (Boston: Cupples, Upham & Colk, 1887), 109.

<sup>140</sup>Hannah Keziah Clapp, “A Salt Lake City Stopover, July 1859,” in *Covered Wagon Women: Diaries and Letters from the Western Trails, 1840–1890*, edited and compiled by Kenneth L. Holmes, 11 vols. (Glendale, Calif.: Arthur H. Clark, 1983–1993), 7:247.

<sup>141</sup>Woodruff, Diary, January 2, 1859.

of the adults attending a Tabernacle service were often women. "The inference to be drawn from this circumstance . . . is self-evident," said English traveler Samuel Day knowingly. He was of course invoking polygamy as the explanation.<sup>142</sup>

There was another characteristic of the Tabernacle's congregation: the "most striking thing" about a Mormon audience was the over-abundance of infants and children. "Certainly every second . . . [woman] had a child with her," said one visitor, and these young Mormons had a way of making themselves known. Even before the organ and choir ended their preliminaries, "the babies began, squall answering to squall throughout the vast edifice," said Henry Lucy, another English traveler. It was a common complaint, as the "superior lung capacity of hungry and uncomfortable children" could easily drown out a speaker's voice in the sound-sensitive building. To quiet their infants, many women breast-fed them during meetings.<sup>143</sup>

What should be done? At times Church leaders advised against bringing infants and young children to the Tabernacle and on still other occasions attempted to still the noise by admonitions from the stand. After one stormy session, President John Taylor, Young's successor, mounted the platform above the speaker and with "threatening attitude and sharp glance" attempted to silence the children, or at least persuade their mothers to remove them from the congregation.<sup>144</sup> However, no remedy seemed to work. The women wanted to attend their meetings—and perhaps to show off their contribution to "Zion's best crop." And Church leaders were unwilling to do more than issue words of caution, which one visitor thought wise. "To make a wholesale raid upon . . . [the mothers and their babies] would have had as much appreciable effect as attempting to empty the Serpen-

---

<sup>142</sup>R. A. N. Harvey, *Life's Real Romance*, 2 vols. (Salt Lake City: J. C. Graham & Company, 1885), 2:66; "The New Tabernacle," *Salt Lake Telegraph*, October 6, 1867, 2; Day, *Life and Society in America* (London: Newman and Company, 1880), 244–45.

<sup>143</sup>Annie Morris, "A Week Among the Mormons," *Lippincott's Magazine* 6 (July 1870): 46; Lucy, *East by West*, 99; Susie Champney Clark, *The Round Trip from the Hub to the Golden Gate* (Boston: Lee and Shepard Publishers, 1890), 161–62.

<sup>144</sup>Olive Rand, *A Vacation Excursion: From Manchester Bay to Puget Sound* (Manchester, N.H.: Press of John B. Clarke, 1884), 191.

tine with a bucket. . . . The babies . . . remained and wailed.”<sup>145</sup>

Tabernacle seating deliberately accommodated visitors, a canny public relations gesture. Usually a Sunday afternoon congregation included over a hundred Gentile tourists, who were given the best seats in the center of the Tabernacle near the rostrum.<sup>146</sup> The Mormons’ graciousness probably had to do with the desire to offset the prevailing negative stereotypes about them and perhaps to proselytize. Could proximity bring better understanding? Of course, the outsiders had their own reasons for coming to the Tabernacle, too. They wanted to see Mormons close-up as part of their touring experience and, according to some reports, were not always well-mannered. Many took “no pains to hide their contempt for all about them and return the courtesy extended by smiles and sneers.”<sup>147</sup>

Another gauge of the visitors’ disdain was their impolite description of their hosts. “One could not but be struck with the plainness of their appearance,” said William Blaikie of the Tabernacle audience. Another traveler complained that he was “unable to pick out from those who sat near me a single *striking* face.” Likewise newspaperman Samuel Bowles found the Mormon congregation to be “as dreadfully commonplace as you can imagine the refuse of the English factory towns, with a sprinkling of the pleasantries of Germany, Finland, Sweden, Scotland, Norway, even Iceland, would be.”<sup>148</sup> In contrast, some visitors were able to look past Utah’s rawboned first generation, who lacked cosmetics and fashion finery, to see something sturdier. “I have seldom seen a more devout and intent assemblage,” said Horace Greeley.

I had been told that the Mormons were remarkably ignorant, superstitious, and brutalized; but the aspect of these congregations did not sustain that assertion. Very few rural congregations would exhibit more heads evincing decided ability; and I doubt whether any assemblage, so largely European in its composition, would make a better appearance. Not that Europeans are less intellectual or comely than

<sup>145</sup>Lucy, *East by West*, 106–7.

<sup>146</sup>Alexander Majors, quoted in Prentiss Ingraham, ed., *Seventy Years on the Frontier* (Columbus, Ohio: Long’s College Book, 1950), 60.

<sup>147</sup>Hubert Howe Bancroft, *History of Utah, 1540–1886* (San Francisco: History Company, 1890), 359.

<sup>148</sup>Blaikie, *Summer Suns in the Far West*, 48; Colman, *Trifles from a Tourist*, 37; Bowles, *Our New West*, 242.

Americans; but our emigrants are mainly of the poorer classes; and poverty, privation, and rugged toil, plow hard, forbidding lines in the human countenance elsewhere than in Utah.<sup>149</sup>

The Mormon celebration of the Lord's Supper, incorporated into the Sunday afternoon "sacrament meeting," was another item that brought comment. Because the Mormons offered the emblems widely and democratically, the logistics alone were impressive. To accomplish the task, the bishops began at the start of the meeting by breaking the stacked piles of bread on the bishops' table into small pieces. The officiator then signaled the speaker to pause for a prayer of blessing, which might be offered by one of the bishops, standing with both arms raised in supplication. After a small squad of men passed the bread to the congregation, a similar ceremony was completed for the sacramental water. Most of the two-hour meeting was required to complete the two ordinances.<sup>150</sup>

Once more visitors again found a chance to ridicule. American aristocrat Rose Pender complained that the bishops broke the bread slices "much as a kitchenmaid shells peas," and when the flagons of water were passed, she noticed a man take "a good pull" and then retrieve the goblet for another drink when his thirst remained.<sup>151</sup> It was a repeated theme: the Mormons seemed to regard the sacramental emblems too casually (President Young himself once cautioned his followers of the impropriety of partaking of the emblems with their hats and gloves on). However, by the close of the century, there were signs that the Mormons wished increased reverence for their ordinance, particularly its administration among outsiders who, while previously allowed to partake of the emblems, showed "by strong demonstration their scorn for the ordinance."<sup>152</sup> Hoping to "properly guard the sacredness of the ordinance," in 1894 Church leaders ended its performance at the Tabernacle and requested Church

---

<sup>149</sup>Greeley, *An Overland Journey*, 222-23.

<sup>150</sup>Joseph F. Smith, Sermon, July 16, 1893, in *Collected Discourses, 1886-1898*, edited by Brian H. Stuy, 5 vols. (Burbank, Calif.: B.H.S. Publishing, 1987-92), 3:308.

<sup>151</sup>Rose Pender, *A Lady's Experiences in the Wild West in 1883* (Lincoln: University of Nebraska Press, 1978), 48-49. Also see Pidgeon, *An Engineer's Holiday*, 248; Romspert, *The Western Echo*, 333.

<sup>152</sup>James Harris, ed., *The Essential James E. Talmage* (Salt Lake City: Signature Books, 1997), 51.



members to partake of the emblems at their neighborhood ward meetings.<sup>153</sup>

The decision was another in a long, step-by-step process. For forty years, Church leaders had slowly moved worship functions from the Tabernacle—once the primary meeting place in the Mormon settlement—to the almost two dozen local Salt Lake City congregations or wards. From the start, weather had been a factor. During winter, the several boweries and even the New Tabernacle—until the late 1880s—had been much too cold for meetings. Off and on, the Saints had tried to use the Old Tabernacle for winter worship; and when that dowdy building finally gave way to the construction of the gothic-inspired Assembly Hall in 1877, even this last building proved too small for community, winter worship. Ultimately, however, it was not the weather that did in the Tabernacle's community-wide services, but logistics: Salt Lake City had too many people and was spread too widely to gather Church members easily to a single location. Although Tabernacle Sunday afternoon services remained a fixture into the third decade of the twentieth century, these meetings mainly were for "out-of-towners," including curious outsiders who still wanted to get a view of Mormon belief and peculiarity.

For many Saints, the change from community to neighborhood worship was wrenching. It ended the chance to rub shoulders with friends and to renew ties on a citywide basis; sociability had always been a large part of the Saints' worship. There was, however, a bright side. The eclipse of community worship and community religious unity were an acceptable price to meet the demands of Mormon growth and success.

There were other changes at the Tabernacle, too. By the 1890s, the cedar festoons were long since removed, and a series of renovations improved and brightened the building. Workmen installed a more efficient heating system and expanded the rostrum once more (by the mid-twentieth century, the "stand" had been altered five times), while new window pulleys and sash lines made summer ventilation easier. On the exterior was a new coat of paint and the roof received new tin sheeting in the 1890s. Whitewash freshened the interior ceiling, and the adjoining walls now had a faint blue marbling. The benches, defaced by several decades of teenage pocket knives, were smoothed and cleaned or replaced, while the gallery columns

---

<sup>153</sup>Ibid.

became more stately with the coloring of a sienna pigment.<sup>154</sup>

The Tabernacle was outgrowing its gawky youth.

Although traces of the Tabernacle's early forms and practices remained in later years, it was in the nineteenth century that it best reflected pioneer culture. Its design had been creative, tradition-defying, and unconventional. It was also practical and simple—with the earlier LDS boweries and tabernacles serving as ties to its camp-meeting heritage. The Tabernacle's huge auditorium with its expanse of hard benches suggested Mormon togetherness—not to mention Mormon disdain for social and economic classes and pretense. It was here that the brothers and sisters in the gospel of Christ could gather in simplicity and oneness. And if pioneer Mormonism was socially and economically egalitarian and democratic, it was also a religious hierarchy, which the Tabernacle's rising, three-tiered, crimson-clothed rostrum symbolized. The prophet's chair was almost an *ex cathedra* element. Even the building's didactic adornments had meaning: mottoes and emblems urged social improvement, while flags and bunting bespoke patriotism. Too, the Tabernacle's practices had their own story. The building's emotional and fervent sermons taught shared feeling and group loyalty, while Tabernacle music expressed Mormon devotion and told the Saints that aesthetics were communal and not individual in their best expression.

The Tabernacle's congregation also conveyed something greater than itself. The men and women who sat in the hall lacked fashionable clothes and deep lines scored in their faces: This was a hard-working and striving society, gathered according to gospel ideal from Europe's toil and religious error. And what about the large number of women in the Tabernacle audience? Had Mormonism attracted a disproportionate number of women or, more likely, were LDS women simply more outward and deeper in their religious devotion? And could anything be more telling than the insistent presence of the Tabernacle's infants and children? Here was proof of the women's kingdom-building—how nineteenth-century Mormon women consciously and unconsciously showed their religious feeling. Finally, the Tabernacle had its Gentile visitors, whose reports were not only important in recording Tabernacle ways but also in revealing

---

<sup>154</sup>"It Looks like New," *Deseret Evening News*, September 28, 1895, 8; "Juvenile Delinquency Posed Problems for Utahns a Century Ago," *History Blazer*, June 1995, 12.

the uneasy and hostile cultural climate that confronted early Mormonism. Wary tension, even antagonism, beat heavily in Mormonism's most secure and public redoubt.

Today the Tabernacle is praised as a building beyond its times—an early, stunning expression of modern architecture requiring that function determine form. Equally, the emotional and sometimes hardy religious activity that once filled the oddly shaped Turtle of Deseret has flowered to become something quite beyond any expectation of its early detractors.

# KERSTINA NILSDOTTER: A STORY OF THE SWEDISH SAINTS

*Leslie Albrecht Huber*

BETWEEN 1850 AND 1905, more than thirty thousand Scandinavians joined the Church of Jesus Christ of Latter-day Saints and immigrated to America.<sup>1</sup> Kerstina (“Karsti”) Nilsdotter was one of them. There is nothing particularly distinctive known about Karsti, her life in Sweden, her conversion, or her journey to America. In fact, little is known about her at all. She did not come from a prominent family and did not leave a journal or autobiography. Accounts of others or local histories of the places in which she lived never mention her.<sup>2</sup> Yet this “averageness” is exactly what makes Karsti so important.

Although there are stories of the first converts, immigrants, and early missionaries that are extraordinary and mostly well documented, they are the exceptions. Karsti’s experiences, in contrast, represent a much larger group: ordinary Swedish Mormon converts who left the familiarity of home and country to come to a new world,

---

LESLIE ALBRECHT HUBER {lahuber@hotmail.com} is a freelance writer in Valencia, Spain. Her articles have appeared in several magazines dealing with family history, history, and other topics. She previously worked as a professional genealogist. Kerstina Nilsdotter is her great-great-great-grandmother.

<sup>1</sup>William Mulder, *Homeward to Zion: The Mormon Migration from Scandinavia* (Minneapolis: University of Minnesota Press, 2000), 102.

<sup>2</sup>The exception is a two-page sketch by Karsti’s daughter Chasty Margaret Harris Albrecht, “Autobiography,” ca. 1940; photocopy of typescript in my possession.

**TABLE 1**  
**KARSTI'S FAMILY OF ORIGIN**

**Nils Nilsson**, born October 12, 1786, Svinarp, Esarp, Malmohus, Sweden; died May 29, 1858, Vallby, Kyrkheddinge, Malmohus, Sweden; married (1) **Anna Jonsdotter** (born ca. 1788, Bonderup, Malmohus, Sweden; died April 6, 1823, Vallby, Kyrkheddinge, Malmohus, Sweden) in Bonderup, Malmohus, Sweden, November 29, 1817

**Children:** born in Vallby and christened in Kyrkheddinge

1. Marna, born October 4, 1818

2. Pehr, born April 4, 1821, died November 9, 1823

Married (2) **Lisbeth Nilsson** (born October 11, 1799, Everlov, Malmohus, Sweden; died January 10, 1847, Vallby, Kyrkheddinge, Malmohus, Sweden) in Kyrkheddinge, Malmohus, Sweden, November 2, 1823

**Children:** born in Vallby and christened in Kyrkheddinge

1. Anna, born December 20, 1824, died January 25, 1847

2. Nils, born May 14, 1826, married Karna Hansdotter February 15, 1856, died 1885

3. Pehr, born March 30, 1829, died January 2, 1833

4. Karna, born July 23, 1831, died January 13, 1847

5. Hanna, born December 26, 1834, married Lars Andersson in November 4, 1859

6. Elna, born February 25, 1839, married in 1861, spouse unknown

7. **Kerstina ("Karsti")**, born August 19, 1843, married Edmond Harris in 1862, died March 14, 1901

vastly different from what they knew. In learning about her, it soon becomes obvious that even the story of an “average” Swedish immigrant convert is nothing less than remarkable.

### VALLBY, SWEDEN

Understanding the magnitude of the changes faced by these converts requires understanding life in Sweden during this period. Kerstina Nilsson was born on August 19, 1843, in the village of Vallby in Skåne, the southern-most province of Sweden. Skåne was known as the “breadbasket of Sweden.” Southern Skåne, where Karsti lived, was made up of miles and miles of green, rich, rolling hills. In the area near Vallby, there was hardly a tree, let alone a mountain, to hinder one’s view. Not surprisingly, most people made their living by farming. Vallby was made up of fifteen farms, with up to five families living on each one.<sup>3</sup>

Karsti was the last of seven children born to Nils Nilsson and Lisbeth Nilsson. (See Table 1.) As a result of her father’s previous marriage and several early deaths in the family, when Karsti was born, the household was comprised of her parents, one half-sister, one brother, and four sisters. Karsti’s father was an *åbo* or tenant farmer, with lifetime and inheritance rights to his land. The family had a small farm, reported to be one-thirty-second of a *mantal*.<sup>4</sup> In this area, one-thirty-second of a *mantal* was probably less than ten acres.<sup>5</sup> People living near the Nilsson family owned farms of a similar size, show-

---

<sup>3</sup>Vallby Clerical Survey Records, Records of Kyrkheddinge Parish, Kyrkheddinge, Sweden, microfilm #145783, Family History Library, Church of Jesus Christ of Latter-day Saints, Salt Lake City (hereafter Family History Library). Although the families were considered to live on the same farm, each had an individual residence and address. Usually, the families were unrelated to one another. This arrangement had occurred over time as people had subdivided their land among heirs or sold pieces of it.

<sup>4</sup>Ibid.

<sup>5</sup>Martin Dribe, *Leaving Home in a Peasant Society: Economic Fluctuations, Household Dynamics, and Youth Migration in Southern Sweden, 1829–1866* (Södertälje, Sweden: Almqvist and Wiksell International, 2000), 27. Because of this, the size of a *mantal* varied from place to place, depending on local factors such as the quality of the land. The concept of a *mantal* had developed centuries earlier and was supposed to be the minimum amount of land a person needed to support his family. Although there

ing that the Nilsson's economic situation was typical.

Karsti's family fell into the category of "semilandless peasants," a group that included farmers who did not own enough land to support their families adequately. These people had to supplement their incomes by working on other people's land occasionally or by conducting a trade on the side. "Landed peasants," in contrast, included farmers with enough land to comfortably support their families (approximately one-sixteenth of a *mantal*). At the bottom of the social order were landless peasants who owned no land and subsisted as day laborers, working on other people's farms.<sup>6</sup> By the 1850s, factors such as the continued division of land among heirs had decreased the size of the average landholdings by common people. Thus, the semi-landless group to which the Nilsson family belonged was expanding rapidly, while the number of landed peasants was decreasing. This declining availability of land became one of the major impetuses behind emigration.

The Nilsson family, like nearly every other family in Sweden, belonged to the state Swedish Lutheran Church. People from Vallby and several other villages attended services in the nearby village of Kyrkheddinge. The local parish pastor represented one of the strongest authority figures in a family's life. Families were expected to attend church, follow regulations for Sunday behavior, and learn Luther's Catechisms. The parish pastor regularly visited the homes of all the families in his jurisdiction, testing their knowledge and understanding of the Catechisms. Church and civil regulations were bound together and rules were rigid, controlling many aspects of life such as freedom of expression and movement between places.<sup>7</sup>

Unlike religion, education was not an integral part of life. If Karsti received an education beyond the Bible and Luther's Cate-

---

were always poorer people who did not own much or any land, in early times most wealthy "landed peasants" did indeed own a *mantal* of land. As time passed, these land holdings were subdivided, particularly in the early to mid-nineteenth century when the population boomed. Fortunately, better cultivation techniques enabled peasants to support their families on less land. Thus, the meaning of a *mantal* changed over time.

<sup>6</sup>Ibid.

<sup>7</sup>Franklin D. Scott, *Sweden: The Nation's History* (Carbondale: Southern Illinois University Press, 1988), 195, 360. The norms and expectations are also evident through the text of the Catechisms themselves. Martin Lu-



*Kerstina Nilsson was christened in this Swedish Lutheran Church in Kyrkhedding, in 1843. All photos by Leslie Albrecht Huber.*

chisms, it was sparse. In 1842 the Riksdag (the Swedish parliament) passed a landmark act, requiring every parish to establish a common school. Before this, only about half of the parishes had schools and generally only boys attended them.<sup>8</sup> Although most people learned to read enough to study the Catechisms and Bible, writing for women was a less common skill. A year before her death, in the 1900 U.S. census, Karsti would report that although she could read, she could not write.<sup>9</sup>

Growing up in mid-nineteenth century Sweden meant that death always lurked around the corner. Nearly every family faced the premature deaths of children or the loss of parents. Karsti's family was no exception. In early 1847 when Karsti was only three, she lost her mother, Lisbeth, and two older sisters—Anna, twenty-four, and

---

ther, *Luther's Primary Works: Together with His Shorter and Larger Catechisms, with Theological and Historical Essays*, translated and edited by Henry Wace and C. A. Buchheim (London: Hodder and Stoughton, 1896).

<sup>8</sup>Scott, *Sweden*, 352.

<sup>9</sup>U.S. Bureau of the Census, 1900, Wayne County, microfilm, #124168, Family History Library.



Karna, fifteen—in a matter of weeks from typhoid fever.<sup>10</sup> Although most deaths occurred among the very old and the very young, Mother Lisbeth's age, forty-seven, was not far short of the normal life expectancy of the time.

While Karsti was still a child, changes in Sweden were occurring that would also impact her life. By 1853 after two unsuccessful attempts, the Church of Jesus Christ of Latter-day Saints had established a presence in Sweden. Membership reached 180 members by the year's end.<sup>11</sup> However, persecutions continued as local leaders arrested, jailed, and even exiled LDS missionaries. These leaders threatened to fine people who held religious meetings in their homes. For secrecy's sake, missionaries organized the first Swedish branch, located in Skönabäck, in the middle of the night. Within a few days, missionaries also set up branches in Malmö, Lomma, and Lund. They organized several more branches also in 1853, all in Skåne. One was in the Nilssons's hometown of Vallby.<sup>12</sup> In the 1854–58 Vallby clerical survey, in the column reserved for remarks, the parish pastor wrote "Mormon" by several names. Two of these individuals were working for Karsti's brother Nils.<sup>13</sup>

Also in about 1853, Karsti's sixty-seven-year-old father passed the farm on to Nils, age twenty-seven, gave up his position as åbo (farmer) and head of the household, and was listed thereafter simply

---

<sup>10</sup>Anna Nilsson, Karna Nilsson, and Lisbeth Nilsson, Burial Records, Kyrkheddinge Parish, Kyrkheddinge, Sweden, microfilm #145782, Family History Library. Unless otherwise noted, all translations of parish records are mine.

<sup>11</sup>Andrew Jenson, *History of the Scandinavian Mission* (New York: Arno Press, 1979), 535. Elder John E. Forsgren first attempted to introduce the LDS Church to Sweden in 1850, the same time at which it was introduced in Denmark. Although he baptized several people, he was soon arrested and exiled. The second attempt in 1852 had similar results. Anders Winberg, a native of Skåne, made the third attempt nearly simultaneously but in a different area. The LDS Church maintained a permanent presence after his efforts. The Church grew more slowly in Sweden than in Denmark or Norway because of Sweden's stricter religious laws. However, by the 1860s, restrictions in Sweden began to loosen; and by the 1880s, there were more baptisms in Sweden than in Denmark.

<sup>12</sup>*Ibid.*, 80–81.

<sup>13</sup>Vallby Clerical Survey Records.



*Although this farmhouse is not the original family home, it stands on the exact plot of land where Karsti's home once stood.*



*View of the farmland from Karsti's home.*

as “widower” in his son’s household, as was the custom. With relatively greater financial security, Nils Jr. married a couple of years later. About this time, Karsti’s two sisters, Elna and Hanna, who were in their late teens or early twenties, hired out to work on neighboring farms.<sup>14</sup> In this time period, young men and women often left home for six months to several years to work as farmhands or maidservants on neighboring farms. This practice eased the financial burden on their families, provided needed labor elsewhere, and gave them important opportunities to learn skills and meet other people. Farmers had the right to treat their employees as they saw fit, resulting in a large divergence in the circumstances and pleasantness of the experience for these young people.

On May 29, 1858, at age seventy-one, Karsti’s father died of “old age.”<sup>15</sup> Fourteen-year-old Karsti was an orphan. For the next two years, she remained in the family home with her brother and his growing family. By law, daughters inherited equally with sons. Karsti probably received title to part of the farm, which she “loaned” to Nils, who would have paid her for its value as he was able. Then in 1860, sixteen-year-old Karsti went to work as a maidservant in Orup, a nearby village, replacing Hanna, who had worked there the year before.

As a maidservant, Karsti likely performed tasks similar to those she had done at home. Workdays often began at daylight, which could be 4:00 A.M. in the summer, and lasted until nightfall. Women and children of all ages, except those of the wealthiest families, helped plant and harvest grain, the region’s major crop. In the winter, the maid servants would distill potatoes into a popular alcoholic drink, *brannvin*, that was consumed at nearly every meal. In the evenings, Karsti may have joined the other women and girls of the community as they worked at their spinning wheels. The women of the house also prepared meals, which commonly included barley porridge or some kind of soup, sausage, cheese, and sourdough bread spread with pork fat. Scandinavian peasants were known for being well fed and were often depicted as plump in illustrations of the time.<sup>16</sup>

With a branch of the LDS Church in Vallby, the teachings of the American church likely formed a lively topic of conversation for

---

<sup>14</sup>Ibid.

<sup>15</sup>Nils Nilsson, Burial Record, Records of Kyrkheddinge Parish.

<sup>16</sup>Allan Pred, *Place, Practice and Structure* (Totowa, N.J.: Barnes and Noble Books, 1986), 77–80.

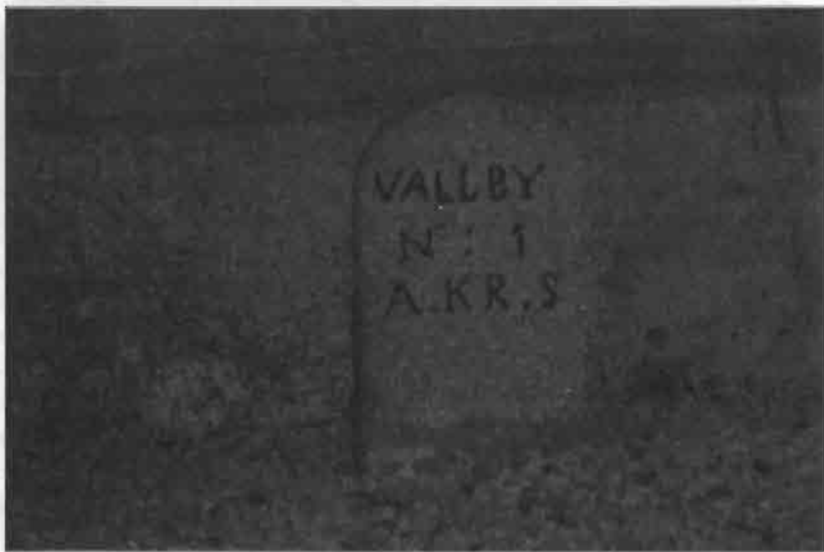

*This stone, engraved “No. 1 Vallby,” gives the address of Karsti’s family and once stood beside the road leading to their home.*

Karsti’s family and neighbors. Although Karsti left no record of her conversion experience, she may well have been surprised by LDS doctrines. As part of the political structure, the Swedish Lutheran Church emphasized authority, obedience, and conformity. As LDS historian Andrew Jenson wrote, this system left many of the peasants “panting for more liberty.”<sup>17</sup> A growing dissident movement in Sweden led to a “Religious Awakening” in the 1850s as people turned away from the formalities that dominated worship in the state church, searching for a more personal and emotional way to connect with God. The LDS Church offered much of what these dissidents sought as the LDS missionaries went from door to door, boldly announcing a new gospel filled with vitality, urgency, and individual involvement. Part of the Church’s success in Scandinavia was due to its reliance on native Scandinavians as missionaries. As historian William Mulder describes it, the gospel was largely preached by converts “baptized one day and sent on a mission nearly the next.” These enthusiastic converts had more credibility than foreigners and were able to relate

---

<sup>17</sup>Jenson, *History of the Scandinavian Mission*, 11.

to the people more naturally.<sup>18</sup>

Anti-Mormon literature also flourished in Vallby, which would have heightened both Karsti's interest in the new religion and the stakes of leaving the church of her childhood for it.<sup>19</sup> Although outright persecution was declining by 1860, prejudice and shunning still occurred regularly. Families sometimes did everything in their power to prevent relatives from joining. It was not uncommon for converts to find that their former friends avoided them. When one convert saw her former pastor in the street, he struck her with his cane.<sup>20</sup>

Baptism into the LDS Church was a consequential decision for another reason: It essentially included an agreement to "gather to Zion," meaning that the converts must immigrate to America. At this time, the "gathering" was a fundamental doctrine, a duty incumbent upon the faithful. The LDS Church offered financial assistance to travel to America as well as support for starting a new life, a dream otherwise out of reach for many Swedish peasants. The statistics testify both to the difficulty of the requirements before new converts and of their commitment. During the life of the Scandinavian Mission (until 1905), nearly a third of the Scandinavian converts apostatized or left the church. Two-thirds of those remaining immigrated to Utah, a number equaling more than thirty thousand people. About 32 percent were Swedes.<sup>21</sup>

Despite the obstacles, on September 5, 1860, Karsti was baptized into the Church of Jesus Christ of Latter-day Saints.<sup>22</sup> It was a decision that the seventeen-year-old made independently. Her brother Nils and his family joined the Church, but not until Karsti had immigrated to Utah. In fact, during the three-month quarter covering this time period, Karsti was the only person baptized in the little Vallby branch. Seldom more than a handful of baptisms occurred during

<sup>18</sup>Mulder, *Homeward to Zion*, 74, 78.

<sup>19</sup>Missionaries in Scandinavia relied extensively on pamphlets by apostles and mission leaders, although most were in Danish during the early time periods. The Book of Mormon was not printed in Swedish until 1878. Popular anti-Mormon materials were *Errors of Mormonism* and *Everyman's Aid in the Fight Against Mormonism*. Ibid., 91.

<sup>20</sup>Ibid., 118.

<sup>21</sup>Ibid., 102.

<sup>22</sup>Kerstina Nilsson, Baptismal Record, Vallby LDS Branch, microfilm #82947, Family History Library.

any quarter. Membership in the branch hovered between twenty and thirty during most of the branch's first ten years and consisted of only twenty-six members at the time of Karsti's baptism.<sup>23</sup>

Without any record or family tradition describing Karsti's feelings, her reasons for making this decision can only be guessed. On the one hand, Karsti had less to hold her back than many others, making the decision seem almost convenient. She was single and an orphan. She did not have a great deal of property to dispose of and had no dependents. All of her siblings except one had married and were establishing their own households. The LDS Church promised a welcoming community and family for her.

Yet at the same time, Karsti did not choose an easy path. Joining the LDS Church was an unpopular decision. Immigrating to America was a dangerous and uncertain undertaking, particularly for a young woman traveling alone who did not speak English. Karsti financed her own emigration, showing that finding an affordable way to get to America was not her motivation. Instead, it seems likely that she shared the feelings expressed by other Scandinavian converts. One convert wrote that upon joining, "I had more happiness than I ever had before."<sup>24</sup> Another explained an emotion that might have also overcome Karsti, "My only desire was . . . to come to Zion."<sup>25</sup>

### THE JOURNEY TO AMERICA

Soon after joining the Church, Karsti began making plans to emigrate.<sup>26</sup> The gathering of Swedish Saints to Zion was part of a much larger emigration that swept through Scandinavia and Europe. Partially due to the population increase, which surpassed the land's car-

---

<sup>23</sup>Skåne District, Swedish Mission, "General Minutes," Archives of the Family and Church History Department, Church of Jesus Christ of Latter-day Saints, Salt Lake City (hereafter LDS Church Archives).

<sup>24</sup>Hans Jensen Hals, "Autobiography," quoted in Mulder, *Homeward to Zion*, 124.

<sup>25</sup>Jens Nielsen, Letter to son Uriah, in Albert R. Lyman, "Sketch of Bishop Jens Nielsen," Utah State Historical Society, WPA Writers' Project Biographies; quoted in Mulder, *Homeward to Zion*, 125.

<sup>26</sup>Available records provide much more information about Karsti's life during her six-month journey to Utah than for any other time in her life. Articles, books, journals, and autobiographies of fellow travelers have described each phase of the route she would have traversed: the ocean voyage,

rying capacity, Sweden was particularly hard-hit by “American fever” and saw the outmigration of more than a million citizens between 1830 and 1930. By 1910, one in five Swedes lived in the United States.<sup>27</sup> Overall, a much higher percentage of people emigrated from northern Sweden, where economic conditions were harder. The Mormon emigration, in contrast, came largely from Skåne, which came to be known as the “cradle of Mormonism.”<sup>28</sup>

Prospective emigrants heard daunting warnings that the trip was long, exhausting, and fraught with dangers and risks. The greatest deterrent, however, was its cost, an insurmountable obstacle for many without assistance. A large number of emigrants relied on Church loans for at least part of the journey. Karsti, however, paid her entire way without help—the sum of between about \$75 and \$100.<sup>29</sup> Of the seventy-two emigrants who left the Skåne Conference at the same time as Karsti, she was one of only eleven who paid in advance.<sup>30</sup> She probably used the money from her share of her inheritance.

Once her finances were in order, Karsti began packing and making other preparations for the trip. She would have relied on the advice of the Mormon publication, *Skandinaviens Stjerne* (*Scandinavian Star*), whose pages were filled with tidbits of advice. The publication admonished travelers to pack lightly and convert valuables into cash to avoid excess freight charges. It also described what clothes, shoes, food, and utensils Karsti would need to bring or acquire in Liverpool.<sup>31</sup>

Despite difficulties ahead, on April 3, 1861, only seven months after joining the Church, Karsti left Sweden, not expecting to see her family again. She had the company of other Latter-day Saints. On that day in April, the parish register shows that six other unrelated

the arrival at Castle Gardens, the passage by train, and the overland trek to Utah. In order not to depart from her life story into a travel narrative, I have selected only some pertinent details to illuminate Karsti’s experiences.

<sup>27</sup>Herman Lindqvist, *A Journey through Swedish History*, translated by Alan Tapsell (Stockholm: Statens Historiska Museum 1994), 72.

<sup>28</sup>Jenson, *History of the Scandinavian Mission*, 54. The *Skandinaviens Stjerne* of July 15, 1861, for example, shows that of the 1,074 members of the LDS Church in Sweden, 557 of them were in the Skåne Conference.

<sup>29</sup>Mulder, *Homeward to Zion*, 146.

<sup>30</sup>Andrew Jenson, “Skåne District, Swedish Mission, Manuscript History and Historical Reports,” LDS Church Archives.

<sup>31</sup>Mulder, *Homeward to Zion*, 165–66.

people from the nearby area also left. In the column for remarks in the register, the pastor simply wrote "Mormon."<sup>32</sup>

The journey to America was a thrilling adventure for Karsti and her traveling companions who likely had never traveled far outside of the parish boundaries. The route took them first to Malmö, and then to Copenhagen. Here, on May 9, Karsti joined a group consisting of 373 Danes, 128 Swedes, and 61 Norwegians to travel to Germany, then across the rough North Sea to Liverpool. In Liverpool, they joined a larger group of 960 people representing ten nationalities to board the *Monarch of the Sea*, the largest sailing ship ever used by a Mormon company.<sup>33</sup>

Despite the excitement of traveling, the daily realities of ship-board life were often tedious and unpleasant. Space was cramped, privacy hard to come by. The living quarters were below deck with only a small door for fresh air and light to penetrate. Passengers slept on narrow bunks, lined up against the bulwarks. Seasickness afflicted many immigrants, and sometimes lasted throughout the voyage. The stench from the vomit and inadequate sanitary arrangements could become suffocating.<sup>34</sup>

The passengers had to prepare their own meals in cramped quarters and with little variety in food. The British Passenger Act (1852) required sailing ships to provide passengers with biscuits, wheat flour, oatmeal, rice, tea, sugar, and molasses. The LDS Church also supplemented these staples. One Scandinavian traveler remembered receiving "cheese, bacon, meat, rice, tea, sugar, potatoes, pepper, mustard and water."<sup>35</sup> In addition, "the sick were

---

<sup>32</sup>Karsti Nilsson, Moving Out Record, Records of Kyrkheddinge Parish, Kyrkheddinge, Sweden.

<sup>33</sup>The *Monarch of the Sea* carried another Mormon emigrant group in 1864. Its two companies were the largest Mormon groups to cross the seas. Conway B. Sonne, *Ships, Saints, and Mariners: A Maritime Encyclopedia of Mormon Migration, 1830-1890* (Salt Lake City: University of Utah Press, 1987), 146-47.

<sup>34</sup>David H. Pratt and Paul F. Smart, "Life on Board a Mormon Emigrant Ship," *World Conference on Records: Preserving Our Heritage*, August 12-15, 1980, vol. 5, series 418: 1-34, 7, Family History Library.

<sup>35</sup>Carl Eric Lindholm, "Diary," in *Our Pioneer Heritage*, compiled by Kate B. Carter, 20 vols. (Salt Lake City: Daughters of Utah Pioneers, 1969),



treated to wine and beer.”<sup>36</sup>

The organization of the LDS companies gave them great advantages over unattached emigrants. Immediately, Church leaders divided the passengers into wards, each with an appointed leader who helped maintain order, enforce standards of cleanliness, care for the sick, set up schedules, hold worship services, and ensure that good feelings prevailed. Church leaders also held prayer services every morning and evening, and taught classes on various topics.

Several passengers who sailed with Karsti wrote accounts of the voyage. One passenger noted, “The voyage was very rough. I can remember the chest sliding and banging from side to side across the wooden floor and all the other chests and trunks with it.”<sup>37</sup> Storms occurred frequently, rocking the boat violently as waves washed over the deck, frightening the passengers.<sup>38</sup> Despite the challenges, one man reported, “Great unity existed among the Saints.”<sup>39</sup>

On June 16, 1861, the *Monarch of the Sea* landed in New York. While Sweden had been at peace since 1814, this new land of liberty had just begun a bitter civil war. Evidence of the war surrounded Karsti’s group from the moment they landed. After disembarking from the ship, Karsti immediately saw “the military parading the streets of New York, and drumming up for volunteers to go and fight the south.”<sup>40</sup> They would travel in the shadow of the Civil War through much of their overland journey.<sup>41</sup>

The next phase of their trip included travel by train and boat and lasted a week and a half. Rail travel was no luxury, especially for

12:478.

<sup>36</sup>Jenson, *History of the Scandinavian Mission*, 155.

<sup>37</sup>Alma Elizabeth Mineer Felt, “Journal,” in *An Enduring Legacy*, 12 vols. (Salt Lake City: Daughters of the Utah Pioneers, 1984), 7:196, in *Mormon Immigration Index*, LDS Church Archives.

<sup>38</sup>Dean L. May, “Rites of Passage: The Gathering as Cultural Credo,” *Journal of Mormon History* 28 (Spring 2003): 28.

<sup>39</sup>Pedar Nielsen, Diary, June 4, 1861, translated by Orson B. West, typescript, LDS Church Archives.

<sup>40</sup>William Probert, Jr., “Autobiography,” in *Biography of William Riley and Hussler Ann Probert Stevens*, compiled and edited by Orvilla Ellred Stevens (N.p.: Privately printed, 1981), 56.

<sup>41</sup>Although the Civil War slowed immigration generally, it did not have this effect on the LDS immigration. In fact, in 1862 more Mormons

the Mormons, who almost always traveled in the cheapest cars, known fittingly as “emigrant cars.”

These crowded and uncomfortable train cars provided few eating and sleeping accommodations. The train cars usually lacked sanitary facilities and drinking water but had an abundance of noise, strong smells, dirt, lice, soot, and all sorts of jerking and jolting about; but the immigrants preferred those to sheep or cattle cars, which some emigrant companies had to use.<sup>42</sup>

After several stops, the group arrived in Quincy, Illinois. On June 26, Karsti and the others took the steamship *Blackhawk* about twenty miles down and across the Mississippi River to Hannibal, Missouri, where they boarded another train. One person commented about this phase of the trip, “The ride was very bad as the cars were terrible.”<sup>43</sup>

Travel across Missouri was particularly dangerous because of the residents’ conflicting sectional loyalties. Rather than let the Union control the railroads, southern sympathizers in Missouri tried to destroy them. This, combined with the general animosity of many Missourians toward Mormons, made the group nervous while traveling across the state. Often when crossing the war-ravaged country, the train-masters boarded over the windows and warned passengers to keep quiet.<sup>44</sup> In one place, a bridge had been burned and the train had to find an alternate route.<sup>45</sup> However, the group made it to St. Joseph, a town on the western border of Missouri, the next day without disaster. From here, they took another boat up the Missouri River to Florence (now part of Omaha, Nebraska).

---

crossed the plains to Utah than in any other previous year. This was partly due to the increased efficiency of the LDS emigration system. However, the Civil War itself also served as something of an impetus, increasing the urgency of many converts to reach Utah. Fred E. Woods, “East to West through North and South: Mormon Immigration during the Civil War,” *BYU Studies* 39, no. 1 (2000): 8.

<sup>42</sup>Stanley B. Kimball, “Sail and Rail Pioneers before 1869,” *BYU Studies* 35, no. 2 (1995): 30.

<sup>43</sup>Nielsen, Diary, June 26, 1861.

<sup>44</sup>John Staheli, “The Life of John and Barbara Staheli,” 2, *Mormon Immigration Index*, LDS Church Archives.

<sup>45</sup>Elizabeth Staheli Walker, “History of Barbara Sophia Haberli Staheli,” *Mormon Immigration Index*, LDS Church Archives.

At that time, Florence was the designated outfitting place for Mormons continuing across the plains by wagon to Utah. Temporary dwellings for the hundreds of people who poured in and out regularly filled the town. Florence also stockpiled large quantities of supplies needed for the westward trek, available for the Saints to purchase. Immediately upon arrival, Karsti and the others in her group began making preparations to continue their trip to Utah.

The Saints of 1861 were the first to participate in the “down and back” plan, designed to reduce the cost of wagon travel. This would provide opportunities to gather to Utah for the growing number of poor Saints unable to complete the journey, while avoiding the hardships of the handcart pioneers. Church leaders also hoped to stimulate the Utah economy. According to the plan, wagon train leaders would come from Utah to Florence early in the spring, bringing extra cattle and Utah grain and other goods to sell to the converts or in the East. They would also bring oxen and wagons borrowed from Saints in Utah. The poor Saints would use these, while those who could afford it would purchase the surplus Utah cattle and other needed goods. The Utah teamsters would then lead the wagon trains to Utah, making the round trip in one season.<sup>46</sup>

Since she was able to finance the journey herself, Karsti traveled in an independent company. Independent companies were composed of emigrants who could fund their own passage across the plains instead of relying on the Church teams. In 1861, eight of the twelve wagon trains (a total of 624 wagons) that left Florence for Utah were independent companies.<sup>47</sup> Karsti’s group, under the leadership of Samuel Woolley, consisted of 61 wagons and 338 people, most of them Scandinavian. Church leaders made an effort to group people of the same nationality for ease in communication and to make the trip more comfortable. On July 13, they set off toward Salt Lake City.

Their passage had only the usual problems and delays caused by bad weather, difficult roads, and runaway oxen. Woolley’s journal records their daily progress, usually about sixteen miles. At least two

---

<sup>46</sup>William G. Hartley, “The Great Florence Fitout of 1861,” *BYU Studies* 24 (Summer 1984): 346–47. See also his “Brigham Young’s Overland Trails Revolution: The Creation of the ‘Down-and-Back’ Wagon-Train System, 1860–61,” *Journal of Mormon History* 28, no. 1 (Spring 2002): 1–30.

<sup>47</sup>Hartley, “The Great Florence Fitout,” 347, 367.

**TABLE 2**  
**KARSTI'S HUSBAND AND CHILDREN**

**Edmond Harris**, born July 9, 1824, Long Crendon, Buckingham, England; married (1) Eliza Barrett; died September 23, 1886, in Gunnison, Sanpete County, Utah

**Married (2) Kerstina ("Karsti") Nilsson** (born August 19, 1843, died March 14, 1901 in Fremont, Wayne County, Utah) ca. early 1862

**Children:**

1. Mary Elisabeth, born December 31, 1862, in Millcreek, Salt Lake County; married Brigham Pierce July 6, 1887

2. Moroni Johns, born November 10, 1864, in Spring Lake Villa, Utah County; died December 10, 1921

3. Ephraim, born October 9, 1866, in Spring Lake Villa, Utah County

4. Chasty Margaret, born June 25, 1868, in Spring Lake Villa, Utah County; married John Albrecht November 27, 1885; died February 15, 1950

5. Rosanna, born July 19, 1870, in Spring Lake Villa; married Henry Albrecht in 1888; died March 15, 1952

6. Rachel Rebecca, born June 23, 1876, in Gunnison, Sanpete County; married Eli Curtis, died April 10, 1898

7. Joseph, born December 30, 1879, in Gunnison, Sanpete County; died June 1, 1884

8. Sarah Ellen, born June 15, 1881, in Gunnison, Sanpete County; married Brigham Pierce March 12, 1913; died November 28, 1941

emigrants died.<sup>48</sup> Another account describes encounters with friendly Indians as well as some minor disputes between travelers.<sup>49</sup>

Finally, on September 22, 1861, the group arrived in the Salt Lake Valley. Many converts felt relief and joy at being in "Zion," but some also felt distress at the harsh desert scene. A Swedish traveler who had also come on the *Monarch of the Sea* recorded her mother's reaction. "With tears streaming down her pale cheeks, she made this remark, 'Is this Zion, and are we at the end of this long weary journey?'" The writer concluded that the desert "must have been a heart-breaking contrast to the beautiful home she had left in Sweden."<sup>50</sup>

### KARSTI'S LIFE IN UTAH

Soon after arriving, probably in early 1862, Karsti married Edmond Harris, a widower nearly twenty years her senior.<sup>51</sup> For Edmond, this marriage was the beginning of a second family. Edmond, who worked as a "carman" (a poorly paid mover of merchandise with a horse-drawn cart) and his wife, Eliza Barrett Harris, a housemaid, had joined the LDS Church in January 1847. Rather than coming to Utah, they instead immigrated to Australia in 1849.<sup>52</sup> In 1855, the couple had accumulated enough money for Eliza to sail for

---

<sup>48</sup>Samuel Woolley, Journal, July-September 1861, microfilm of holograph, LDS Church Archives.

<sup>49</sup>Nielsen, Diary August 1861.

<sup>50</sup>Felt, "Journal," 200.

<sup>51</sup>No record exists of the original marriage, and their temple sealing occurred much later. Since Karsti did not arrive in Utah until September 1861 and their first child was born December 31, 1862, it seems likely that they married in early 1862.

<sup>52</sup>It is not known why Edmond and Eliza went to Australia. Australia's gold rush did not occur until after their arrival, so it could not have been a motive. Interestingly, another Mormon man (William Barratt) and a Mormon family (Andrew and Elizabeth Anderson and their children) immigrated to Australia from England. They had been instructed to preach the gospel in Australia, prior to the arrival of missionaries (1851). Possibly Edmond and Eliza had a similar responsibility. Marjorie Newton, *Southern Cross Saints: The Mormons in Australia* (Laie, Hawaii: Institute for Polynesian Studies, 1991), 23-27. Edmond and Eliza emigrated as part of a government-assisted program that underwrote the emigration to Australia for two-thirds of its 170,000 emigrants between 1831 and 1850. Ken Inglis, *Aus-*

Utah with a group of Mormon emigrants aboard the *Julia Ann* with their two children, Maria and Lister. Edmond planned to join them after he had saved more money.<sup>53</sup> The *Julia Ann*, however, was shipwrecked, and Eliza and Lister were among the five casualties. Although Maria survived, she has been lost to history, never appearing in any records with Edmond again. Edmond left Australia in 1857 aboard the *Lucas*. He landed in California and spent some time there before continuing on to Utah.<sup>54</sup>

Edmond and Karsti first resided briefly in Millcreek, south of Salt Lake, where their first child was born. By 1864, they had settled in Spring Lake Villa, a new settlement in Utah County, halfway between Payson and Santaquin. During their eleven-year stay in Spring Lake, Karsti and Edmond added at least three children to their family. (See Table 2.)<sup>55</sup> At the time, only a handful of families lived in Spring Lake. The Harris family probably built their new residence themselves, living in a small, temporary dwelling or dugout in the meantime.

Karsti had to adapt to new circumstances in Utah. Life in "Zion" was anything but easy. First, there was the challenge of learning another language. Almost immediately after joining the LDS Church in Sweden, Karsti likely began studying English, an attainment that was

---

*Australian Colonists: An Exploration of Social History 1788-1870* (Melbourne, Australia: Melbourne University Press, 1993), 21.

<sup>53</sup>John Devitry-Smith, "The Wreck of the *Julia Ann*," *BYU Studies* 29, no. 2 (Spring 1989): 3.

<sup>54</sup>The Australian Saints on board the *Lucas* headed immediately for San Bernardino, whose population was evacuated to Utah shortly after Edmond's arrival. According to the 1860 U.S. census, Edmond was likely living in San Francisco, perhaps looking for Maria, since her ship docked there. No records in Utah contain information about Edmond and Maria together. Maria probably died as a child in California or became integrated into another family.

<sup>55</sup>Likely the family had one or more additional children in Spring Lake, and perhaps also another child in Gunnison, who are not included on family group sheets. The spacing of the children shows gaps large enough to include additional births, especially between 1870 and 1876. According to the 1900 U.S. census, Karsti had eleven children, only five of them still living. Family records show only eight children.

heavily stressed for converts.<sup>56</sup> This effort continued during her voyage. Marrying an English-speaking spouse would have accelerated the process.

Making a living in Utah was also much different than in Sweden. In Utah frontier towns, in addition to using any skills they might possess to produce needed goods, nearly everyone farmed. This would have been an adjustment for the Harris family. Edmond, the son of a blacksmith, had never farmed before. Although Karsti grew up on a farm, Utah's arid land, which required irrigation, was nothing like the fertile plains of Skåne. Bad weather and thick swarms of grasshoppers periodically threatened the crops. Farmers in Spring Lake also grew a wider variety of crops than in southern Sweden: corn, sugarcane, potatoes, tobacco, and hemp among others.<sup>57</sup>

As in Sweden, Karsti likely labored in the fields. However, the isolation of their location in Utah required pioneers to obtain a level of self-sufficiency unknown in their former countries. Until the railroad was completed in 1869 providing a link to eastern goods, Utah residents had little choice but to make nearly every item they needed including clothing, furniture, and tools.

In addition, Karsti's "village" in Utah differed considerably from her Swedish village. She had fewer neighbors in the sparsely settled village; and in Spring Lake, she probably had more Indian than white neighbors. One was the famed Black Hawk, leader of the Ute Indians in the Black Hawk War. Spring Lake was his birthplace and would be his death place in 1870. When the Harris family first arrived, interactions between the Mormons and the Indians in Spring Lake were friendly. However, in 1865 when war broke out, relations began deteriorating. The Spring Lake residents chose not to follow advice from Brigham Young to move temporarily to Santaquin during the hostilities and instead stayed in a local home that they converted to a fort during the worst of the conflict.<sup>58</sup>

In 1874, Karsti and her family moved south to Gunnison, located in Sanpete County. Her brother, Nils, had been baptized in August 1862 and emigrated in early 1863 with his wife, Karna, and their

---

<sup>56</sup>Mulder, *Homeward to Zion*, 128.

<sup>57</sup>Spring Lake Branch, Utah Stake, "Manuscript History and Historical Reports," LDS Church Archives.

<sup>58</sup>Brigham Young, Letter to Benjamin F. Johnson, Spring Lake Villa, January 30, 1866, LDS Church Archives.

children, settling in nearby Mount Pleasant.<sup>59</sup> At this time, Sanpete County was known as “Little Denmark” because of its large Scandinavian population. Although much larger than Spring Lake, Gunnison was still only a small, rural community. In 1870, a few years before their arrival, a postmaster indicated where ninety families lived in the area and described the fields there as “barren and desolate.”<sup>60</sup>

As soon as they arrived, the Harris family, along with about three hundred other people, joined the newly organized effort at communal living known as the United Order.<sup>61</sup> Their contribution of “stock” was one ox, an indication of their straitened means.<sup>62</sup> For a short time, committees directed a range of activities including farming, herding, salt boiling, and harness making. The United Order also took over the gristmill and the cooperative store. Like most of the United Orders started at this time, the one in Gunnison was short-lived. Efforts at community building continued, though. While the Harris family lived in Gunnison, residents completed a Relief Society building and a tithing house, and also helped construct the Manti Temple.<sup>63</sup>

In Gunnison, the Harris family grew to include at least eight children, of whom at least one died. The family had to work hard just to survive. A local history reported, “In addition to caring for her family and helping with the hard work, each pioneer mother waged a con-

---

<sup>59</sup>Nils Nilsson, Baptismal Record, Vallby LDS Branch. They sailed on the *John J. Boyd*, which arrived in New York on June 1, 1863.

<sup>60</sup>Centennial Committee, eds., *Memory Book to Commemorate Gunnison Valley's Centennial, 1859-1959* (Gunnison, Utah: Gunnison Centennial Book Committee, 1959), 48.

<sup>61</sup>The United Order movement began under Brigham Young in 1874, drawing on earlier instructions and attempts under Joseph Smith. Participants devoted all their resources to the Church and were assigned a “stewardship” over which they had control. By the fall of 1874, two hundred separate community United Orders had been established, at least on paper. Because participation was voluntary, many barely functioned and only a few lasted more than a year. Dean L. May, “The United Order Movement,” *Utah History Encyclopedia*, retrieved on July 1, 2004, from <http://www.media.utah.edu/UHE/u/UNITEDORDER.html>.

<sup>62</sup>Gunnison Ward, Sanpete Stake, “Historical Record, 1874-1894,” LDS Church Archives.

<sup>63</sup>Centennial Committee, *Memory Book*, 49-51.



stant war on the lizards, snakes, and rodents that would share her dwelling in spite of all she could do.”<sup>64</sup> Chasty, the only one of Karsti’s daughters to write an autobiography, recalled: “I spent most of my time helping mother weave rag carpets. We were very poor and sometimes didn’t have all the dry bread we needed to eat. When I was twelve, I started to hire out anywhere I got a chance. I earned my own clothes and helped Mother and Father all I could.”<sup>65</sup>

Records in Utah reveal little about Karsti and her family, as most are sketchy during this early period, but all emphasize the hardscrabble life in rural Utah during this time. The other aspect of Karsti’s life revealed by the scanty surviving information is her continued commitment to the religion she embraced as a teenager. Ward records in Gunnison show the family’s continued involvement, including dates the family moved in and out of the ward, baptism dates for two of the children and a birth and blessing date for one child.<sup>66</sup> On August 28, 1875, Karsti received a patriarchal blessing, again an act that shows her faithfulness.<sup>67</sup> He advised her: “Listen to the councils [sic] of God’s servants and press forward to serve him and thou shalt wield an influence that shall be felt by all around thee for good.” In addition, many of Karsti’s descendants remained active members of the LDS Church, suggesting that they learned principles of the gospel in her home.

In 1886, after twelve years in Gunnison, Edmond died. Karsti moved farther south to Fremont, a new settlement in Wayne County, where her daughter (Chasty Harris Albrecht) and son-in-law (John Albrecht) lived with their family. Karsti died in Fremont on March 14, 1901, age fifty-seven.

### CONCLUSION

Today, little remains of Karsti’s life except her descendants.

---

<sup>64</sup>Ibid., 65.

<sup>65</sup>Albrecht, “Autobiography.”

<sup>66</sup>Harris Family, Moving In, Moving Out, Baptism and Burial Records, Gunnison Ward Records, microfilm #25977, Family History Library. The lack of baptismal or blessing information for other children does not necessarily indicate that these ordinances did not occur. The records are very incomplete.

<sup>67</sup>Karsti Nilsdotter, Patriarchal Blessing, photocopy in my possession.

Even the location of her grave is unknown.<sup>68</sup> The Swedish language, customs, and stories were lost to time, even among her family. No information about her personality traits or insights into her thoughts or feelings has survived. However, assumptions can be made about the kind of person Karsti was based on her life choices. Karsti must have been an independent thinker, willing to go against the norms and expectations around her. She must have possessed courage to make the decision to join the Church and immigrate to America at such a young age. Most of all, though, Karsti must have possessed deep reservoirs of perseverance to endure the arduous journey followed by the continual hard work and struggle for survival she faced throughout her life in Utah. Other Swedish immigrant converts likely possessed similar characteristics.

Karsti's legacy continues, both individually and as a part of a greater movement. The Scandinavian Saints made up an important component of the Mormon immigrant converts. By 1900, people of Scandinavian origin made up 16 percent of Utah's total population, giving Utah a "remarkably Nordic cast."<sup>69</sup> Karsti's story is the story of these people who left behind all that they knew to face the unknown in the unsettled West. Despite resistance in their home country, a perilous journey, and only the promise of building a home on the frontier desert, thousands like Karsti chose this path.

---

<sup>68</sup>Both the daughter and son-in-law with whom Karsti lived at the end of her life are buried in Fremont, but Karsti is not. Nor is she buried in Gunnison where Edmond lies.

<sup>69</sup>Mulder, *Homeward to Zion*, 102, 197.

## REVIEWS

John Sillito, ed. *History's Apprentice: The Diaries of B. H. Roberts, 1880-1898*. Salt Lake City: Signature Books in association with Smith Research Associates, 2004. xliii, 348 pp. Photographs, maps, index. Cloth: \$100; ISBN 1-56085-173-2

*Reviewed by Davis Bitton*

Diaries are usually utilized by family members, historians, and a few devotees. The general reader doesn't rush to purchase and read the diaries of anyone. Realizing these hard facts, the present publisher limits this edition to five hundred copies. These B. H. Roberts diaries thus join others in the same series. I applaud the effort.

There is much to commend in the patient editorial work of John Sillito, archivist and curator of Special Collections at Weber State University. He has carefully used brackets when inserting anything, even a punctuation mark, not found in Roberts's original handwriting. In a good decision, Sillito has standardized the dates of the individual entries, square brackets letting the reader know that this slight transformation is the work of the editor, not Roberts.

A tedious but necessary task for editors of diaries is identifying names. Again Sillito has done a workmanlike job. We cannot tell where he got the information for each separate name, but the introduction (xlii) lists his main sources.

A section of contemporary photographs, mostly portraits, and the five maps in another section are helpful features of this work, attractively presented. A photograph of Roberts and his missionary companion Joseph Ford in 1882 is thus identified, but with this addition in the caption: "Notice the string tie to Roberts's hat that has fallen across his forehead." Even with a magnifying glass, I see a small, unobtrusive line but not a "string tie." A portrait of Roberts and his wife Margaret in the 1920s is accompanied by these words: "Notice the clothes pin in Margaret's hat." I think it is a *hat* pin. These are slight matters.

With information drawn mainly from Gary Bergera's edition of Roberts's "autobiography" and from *Defender of the Faith* by Truman G. Madsen, Sillito's introduction provides an overview of Roberts's life. Much is left out, but this is, after all, a summary. To help those who may be unfamiliar with Mormon usage, a glossary discusses terminology (vi–ix). Only in the discussion of the "ward" do I find statements that seem wobbly.

Roberts, we are told, was "never far from alcohol" (xiv). But how serious was this drinking problem? Its roots are in a generation when total abstinence was encouraged but not insisted upon. How often did he imbibe and how much? On September 28, 1881, he wrote: "Spent the day in studying Scripture. I feel bad because my old weakness stil is not overcome" (13). The editor's footnote tells us: "Roberts likely refers to his life-long struggle with alcohol. At the same time, he struggled with depression and severe headaches, all of which may have been related—alcohol being a medication for headaches." Two years later on September 20, 1883, Roberts wrote: "I suffered much from headache, and at Knoxville I took a dram of Rye whiskey—the first I ever took while on a mission. It deadened the pain in my head" (142). To judge from the diaries, this problem was by no means a central obsession of his life. His record of industry and accomplishment year after year and his ability to preach in a way that inspired people should at least serve as a counterweight on the other side. Missionaries like Henry D. Taylor, who served under his direction, living in the same home and spending many hours in his company throughout the day, had enormous respect for him, suggesting that he kept the problem in check.

Sillito notes that missionary service in England brought Roberts "close to culture and ideas which were unavailable in Davis County." He and other missionaries obtained "a broader, if not always enlightened, world-view" (xvi). Isn't that "not always enlightened" a bit supercilious?

Roberts was a missionary in the South, but was not "enlightened" apparently, for our editor wishes that Roberts had "paid attention to the social conditions in Tennessee and elsewhere while he was laboring there" (xviii). Could it be that he saw things pretty much as all Caucasian Americans did at the time? Their own lives on the line, Mormon missionaries were often themselves the targets of the Ku Klux Klan.

My queries and quibbling notwithstanding, the introduction does a reasonably good job of what the editor wished to do.

But just how *significant* is this record? Ideally it would tell us a great deal about Roberts and about the Church of Jesus of Jesus Christ of Latter-day Saints during his lifetime. After all, he was a lively character, one of the Seven Presidents of Seventy from 1888 to his death in 1933, and personally involved in many of the larger events of his time.

In the interest of accurate billing, I must point out that these are not

the diaries of B. H. Roberts for the nineteen years from 1880 through 1898, as the book's title might suggest or as a prospective reader might presume. According to the table of contents, they are instead diaries for 1880-81, 1882, 1883, 1884, 1885, 1886-87, 1890, 1891-92, 1893, and 1898. There is nothing for 1888, 1889, 1894, 1895, 1896, or 1897, all important years for Roberts and the Church,

Even within the years here represented the coverage is limited. Entries for 1890 begin on November 3, leaving out the drumbeat of increasing pressures that led to the Woodruff Manifesto. Entries for 1893 end with June 24. Thus, we read of Roberts's preparing an article to deliver at the Columbian Exposition (303), its approval by the First Presidency (305), and his preparing a paper to be delivered by Emily S. Richards (307). But we miss out on Roberts's own frustrating experience in Chicago, where he attempted to have Mormonism included as a "world religion."<sup>1</sup>

The year 1898 is briefly touched upon, but coverage ends on February 5. Thus, we miss out on Roberts's election to the U.S. House of Representatives and the subsequent hearings that made him a national celebrity.<sup>2</sup>

No one can blame John Sillito for these gaps. He has edited and published the diaries available to him. I merely wish to underscore what is and what is not included.

Among the valuable inclusions are the following:

A wonderful entry on the grandeur of English scenery, August 8, 1887, ends: "I certainly hope the result will be to refine this rather cross grained nature of mine, which is sorely in need of such influences" (199).

The busy life of this young General Authority in 1890 shows him editing a newspaper, speaking at political rallies, writing on several projects at the same time, and commenting on other individuals. Introspection is found on November 8. Having failed to enjoy "liberty" in his preaching that day, Roberts blames the coldness and indifference of the people but worries that part of the fault might rest with him (206). On December 11, the last entry for the year, he writes a moving prayer, including these words: "Help thy servant to keep the path direct, neither turning to the right or left. And in as much as thou wilt enable me to sustain my family I will devote myself to the ministry to the extent that Thou wilt give the ability to do so. . . . Here is my

---

<sup>1</sup>See Davis Bitton, "B. H. Roberts at the World Parliament of Religions," *Sunstone* 7 (January/February 1982): 46-51.

<sup>2</sup>Davis Bitton, "The B. H. Roberts Case of 1898-1900," *Utah Historical Quarterly* 25 (January 1957): 27-46; revised in Bitton, *The Ritualization of Mormon History and Other Essays* (Urbana: University of Illinois Press, 1994), 150-70.

hand lead me wheresoever Thou wilt and I will gladly follow" (218).

The chapter for 1891–92 is a retrospective account of some events in those years (and some valuable paragraphs about 1890) written by Roberts in early 1893. At a stake conference on June 3, 1893, Roberts urged local leaders to make these meetings interesting and for the people to support them with faith. "Time will come," he continues, "when the work will be so extensive that Apostles will rarely be seen at Stake conferences" (303). A list of such examples could go on and on.

In short, despite gaps, these diaries preserve many details and valuable perspectives. As always, they should be supplemented and controlled by other primary source materials. Even as they stand, they tell much about B. H. Roberts and the years covered. Both John Sillito and his publisher deserve commendation.

DAVIS BITTON is emeritus professor of history at the University of Utah. He compiled *Guide to Mormon Diaries and Autobiographies* (Provo, Utah: Brigham Young University Press, 1977). His *George Q. Cannon: A Biography* (Salt Lake City: Deseret Book, 1999) received the Best Book Award from both the Utah State Historical Society and the Mormon History Association.

---

Martha Beck. *Leaving the Saints: How I Lost the Mormons and Found My Faith*. New York: Crown, 2005. 320 pp. Cloth: \$16.47; ISBN: 0-6096-0991-2

*Reviewed by Boyd Jay Petersen*

This memoir, which is packaged as a spiritual journey out of Mormonism and into faith, has created controversy because of the hotter topic of recovered memories of sexual abuse. It has relevance to those interested in Mormon history for three reasons: (1) The large body of literature created by former Mormons has been understudied, probably because much of it uses the forms of classic (and offensive) exposé; (2) Accounts of sexual abuse among Mormons, while not surprising, are still comparatively rare, and this book is the first to accuse a relatively well-known Mormon and find a national publisher; and (3) Mormon women's autobiography, which has roots going back to Lucy Mack Smith's family memoir dictated in 1844–45, is a respected part of the Mormon literary history.

All three contexts offer what I consider to be helpful interpretative backgrounds for appraising this work. The reader should also be aware that I am the biographer of the accused perpetrator, Hugh Nibley, and the brother-in-law of the author, Martha Beck, and must therefore make up his

or her own mind about how successful my effort is.

My lengthier response to *Leaving the Saints* focuses on specific issues of Beck's credibility.<sup>1</sup> Beck hypothesizes that her father suffered from unresolved issues of being sexually abused by his own mother (I found no evidence for this) and also from Post-Traumatic Stress Syndrome as a result of grisly experiences during World War II (I believe he did suffer from the trauma of war, but he obviously recovered by the time he began a family in 1946 because no family members witnessed any signs of PTS).

When the Joseph Smith papyri were acquired by the Church in 1967 and Nibley was expected to translate them, Beck then claims that he "went crazy" when faced with two equally unpalatable alternatives: He could admit that the papyri contained an Egyptian funerary document unrelated to the Book of Abraham and lose both position and social status, or he could "lie flat out" (148). (Beck fails to acknowledge the fact that it was Hugh Nibley who first pointed out that the papyri contained the Egyptian Book of Breathing rather than the Book of the Dead, as others believed.) It was while he was in this mentally unstable state, she suggests, when she was between ages three and five, that some fuzzily remembered memories/dreams of sexual abuse with ritualized elements occurred. None of the other seven Nibley siblings can recall either incidents of abuse or corroborating evidence of such. I take the unequivocal position that Hugh Nibley did not sexually abuse Martha and that her version of many other experiences is highly distorted.

My focus here, however, is more on issues of Mormon history. *Kirkus Review's* brief notice (December 15, 2004): 1174, specifically praises the book as "not a trashy exposé but a loving, sad account of coming home again." However, those familiar with the genre will find in this book the one-dimensional caricatures of Mormons, superficial portrayals of historical events, and the same standard motifs of nineteenth-century anti-Mormon exposés.

1. Joseph Smith's ability to impress the gullible with his forceful personality. Here Beck sees Joseph Smith's charisma primarily emanating from his "magical ability to translate ancient documents" which would "inject his followers with a fresh dose of enthusiasm and belief in their leader's prophetic powers" (155).

2. His claims as a "translator" that produced the Book of Mormon and the even stranger Book of Abraham. Beck states that the "contradictory evidence" to the Book of Mormon's claims brings out "apologists to rush in, like

---

<sup>1</sup>My "Response to Leaving the Saints" was initially posted on Sunstone's website and is currently posted on FAIR's website at <http://www.fairlds.org/Reviews/Rvw200504.html>.

white blood cells attacking a virus" (4). Beck dismisses the Book of Abraham as "kind of kooky," says its "Egyptian material" reads like "the graffiti from a psych-ward restroom," and calls the "Mormon beliefs spelled out in the Pearl of Great Price . . . as nutty as a Hickory Farms cheese log" (158–59, 170).

3. Joseph Smith's introduction of polygamy, ostensibly as a commandment from God as part of the "restoration of all things" but actually to provide greater variety in his sex life. "Historians quibble over how many women [Joseph] married," Martha opines, "but the number was probably somewhere in the forties—more than a grundle, less than a horde" (153).

4. The dictatorial nature of Church governance, which manifests itself in the late nineteenth-century context as oppression of women. "Men are to be pleased and protected," Beck advises, "both in fundamentalist Mormon homes and in blue-blood pioneer families, and women are to do what they're told. This includes excusing or ignoring sexual shenanigans on the part of the patriarch and siding with the male authority figure in any 'he said, she said' conflicts" (178–79).

5. The strange secrets of the temple endowment. Beck avoids giving specific details of the temple ritual because, as she quips, "I think maybe I agreed to have my entrails carved out if I ever did such a thing, and there's nothing like a blood oath to put the old kibosh on one's natural chattiness." She does devote an entire chapter to mocking the temple ceremony, describing a temple worker "hissing like a puff adder" when she "jammed the veil onto my head," her husband's temple clothes as making him look like the Pillsbury Dough Boy, and "an ancient, feeble male temple worker [leading the session] in much the same way aerobics classes are led" (14–17).

6. Fear of reprisal by Danites. In addition to Beck's reports of threatening notes, anonymous letters, threatening phone calls, (223, 237, 241), and a bugged telephone, she says that her friends warned that her life was in danger and feared that the "Strengthening the Membership Committee" [sic; actually "Strengthening Church Members Committee"] are recording their license plates if they came to visit (251, 236, 119, 259). While "Utah's lunatic fringe" (251) can be a realistic fear, Beck connects such fears explicitly with "murder . . . by temple-sanctioned methods," after which "the word that goes out on the Latter-day grapevine is *Danite*" (190).

By adding sexual abuse to this mix, Beck has simply continued one of the important functions of Victorian exposés of Mormonism first noted by Craig Foster: the presentation of eroticized material under the guise of scandalized morality.<sup>2</sup>

One detail reveals a great deal about the way this book is written.

<sup>2</sup>Craig L. Foster, "Victorian Pornographic Imagery in Anti-Mormon



When Beck visits a therapist to whom she assigns the pseudonym (“Let’s call her . . .”) Rachel Grant, then wonders to herself “if Dr. Grant was descended from . . . Heber J. Grant” (234). Readers of Mormon history will quickly recognize “Rachel Grant” as the name of Heber J. Grant’s mother, Rachel Ridgway Ivins Grant, and his daughter, Rachel Grant Taylor. Then Beck proceeds to recount an amusing family anecdote about how her grandfather, Alexander Nibley, accompanied the tone-deaf President Grant as sang his limited repertoire of hymns to illustrate the principle of persistence. The sly Alexander would change keys “in the middle of prophet’s performance,” excruciatingly obvious to the audience but not to Grant (234–35). From a historical perspective, this anecdote is distressing since the actual name of the therapist was Ruth Killpack, a family name shared by no General Authority—past or present—of whom I am aware. Beck combines fact with fiction to flesh out a good story.

A related issue is Beck’s portrayal of the environment at Brigham Young University in the early 1990s. It was admittedly a time of turmoil and emotional trauma, with Church authorities exerting more control over the BYU Women’s Conference, young scholars being fired, and two former BYU professors being excommunicated. However, Beck’s description of this milieu is hyperbolic. For example, she describes a trip to the BYU library to do research on Mormon dissident Sonia Johnson, where she assures us that “not a single reference to her showed up on the library’s retrieval system.” “The articles were simply missing” (83). Just by searching the library’s online catalogue, I discovered more than forty references for information on Sonia Johnson, and Johnson’s book *Housewife to Heretic* is located in both special collections and in the general stacks where any undergraduate can check it out.

Although Beck insists on her “love affair with evidence” (5) and reminds us many times of her credentials as a Harvard-trained sociologist, her work does not demonstrate an ability to deal with the genuine complexities that underlie the major events of Mormon history. The result is a simplistic summary of Mormon history and a badly skewed presentation of Mormon life in Provo, Utah, between the 1960s and 1990s. Beck presents herself as able to enjoy a richly affirming spiritual life because she has shed Mormonism. In so doing, she follows the well-worn path of the Victorian exposé writer who typically turns to “true religion” after escaping the horrors of Mormonism.

It is interesting to contrast this memoir with the more challenging and complex negotiations worked out by the six twentieth-century Mormon

women writers treated in Laura L. Bush's *Faithful Transgressions in the American West: Six Twentieth-Century Mormon Women's Autobiographical Acts* (Logan: Utah State University Press, 2004). Bush analyzes the life writings of women like Mary Ann Hafen, Annie Clark Tanner, Juanita Brooks, African American Wynetta Willis Martin, Terry Tempest Williams, and Phyllis Barber to show how they have found ways of simultaneously resisting, reinterpreting, and remaining attached to Mormonism. Martha Beck should be able to provide us with better than we get in *Leaving the Saints*. She is a gifted writer, the book is well-paced, the writing is lively, the description is vivid, the wit sparkles. But this book will take its place among other unreliable anti-Mormon exposés.

BOYD JAY PETERSEN {boyd.petersen@comcast.net} is the author of the prize-winning biography *Hugh W. Nibley: A Consecrated Life* (Salt Lake City: Greg Kofford Books, 2002). He and his wife, Zina, are the parents of four children. He currently teaches in the English Department at Utah Valley State College and is finishing a Ph.D. in comparative literature at the University of Utah.

---

Donald Q. Cannon, Richard O. Cowan, et al. *Unto Every Nation: Gospel Light Reaches Every Land*. Salt Lake City: Deseret Book, 2003. v, 598 pp. Illustrations, chronology, endnotes, index. Cloth: \$29.95; ISBN 1-57008-948-5

*Reviewed by Kahlile B. Mehr*

The purpose of the book is clearly stated and the tone plainly denoted in the preface. This volume will look at the "fascinating and inspiring events" of the Church in all areas of the world in order to "strengthen your testimony and inspire you to play your part in accomplishing God's purposes. . . ." Meant as a replacement for an outdated text on the international Church for Brigham Young University course work, it was nevertheless published by Deseret Book as an item of general interest for Church members. Authored by BYU professors of Church doctrine and history, it provides a perspective for the faithful on the international expansion of the Church which started fitfully in the nineteenth and continued more forcefully in the twentieth century.

The book is primarily a narrative of events. It recounts the struggles that accompany missionary work when the gospel is introduced into a new area. "In missionary work, the beginning stages are also generally the hardest" (66). It tracks country dedications, the creation of missions, stakes, temples, membership growth, and the calling of foreign leaders as General Au-

thorities. It traces the Lord's hand in preparing the way for the gospel in creating favorable circumstances. For instance, it suggests that the historical and cultural circumstances fostering quick growth in the Philippines were a positive attitude toward the United States, religious freedom, a cultural disposition of friendliness toward and cooperation with strangers, regard for family, and veneration of ancestors (362).

It relates miracles large and small that show divine assistance. The collapse of Communism is connected to the statement of President Spencer W. Kimball in 1974 that the Lord would open doors to countries only when the Church was prepared to enter. Hence, the demise of Communism shows that the Lord can make anything happen if his Church is ready to take advantage of it (115). Small miracles include, for example: the earthquake that unleashed the water supply to sustain the Mormon colonies in northern Mexico (242); the prayer that extended a roof beam to complete a chapel in Bolivia in time for its dedication by Elder Spencer W. Kimball (282); and Mission President Glenn Rudd's finding an investigator in Santiago, Dominican Republic, when he did not have an address or any way to contact her (473).

There is some overstatement. For instance, the book states that the growth and globalization of the Church between 1830 and 2000 is "truly astonishing" (v). The Church's growth is remarkable but, in truth, it is still primarily a western hemisphere Church. Its expansion has slowed in recent years despite an expanding missionary force. A similar statement is that "consistent growth in the face of obstacles [in western Europe] is not less than astonishing and remarkable" (112). In reality, growth there has been sporadic, is currently stagnant, and the active membership is even declining. A quick review of *Church Almanac* statistics shows that, during the last decade of the twentieth century, western Europe membership grew at a fourth the rate of the total Church; two countries lost membership, four grew by fewer than a thousand, four gained in the low thousands, and only Spain showed a substantial gain (8,000 members). In another overstatement, the book states that the baptism of ninety-six converts during the first five years of the Argentina mission was a "firm foundation." This is doubtful (266).

Yet there are soberer assessments such as the statement that, while the Church has made great strides in Hong Kong and Taiwan, its membership is but a "tiny fraction of the billion Chinese who are yet to be taught the gospel" (358). A summary assessment in the conclusion indicates that there are about five hundred people for every Latter-day Saint worldwide, showing that there is a long way to go before Daniel's prophecy is fulfilled (515).

The book does not omit discussion of significant problems that have hindered Church growth. For instance, it notes decades of inattention to many countries in the later nineteenth century after an initial missionary ef-

fort—such as the forty years when nothing happened in Australia (164). It points out that the concept of gathering applied in the Pacific has not been successful (186). It does not omit the embarrassing incident in Thailand when an elder had a companion photograph him atop a statue of Buddha, causing severe repercussions (370). It recounts external events such as when the legislative assembly of Tonga decided Mormons were undesirable (200), when other Christian churches opposed the Church in Singapore (374), or when the Indonesian government severely restricted visas in 1978 before denying them entirely from 1980 to 1993 (378–79).

While the book is heavily narrative, there are two summary chapters at its end on administering the worldwide Church and assessing how far we have come that provide some analysis and perspective on the narrative chapters. There is also a three-page assessment of the Church in the Pacific (227–29). Otherwise, the concluding statement for any particular narrative chapter is one to three paragraphs.

While the book has a comprehensive grasp of the challenges to Church growth, a few themes are insufficiently developed. One is the adaptation of the Church to cultures that differ greatly from that existing in North America. It is the focus of the introduction but is supported only superficially. Another for which there are numerous examples in the book, but no summary statement, is the common disposition of people to stick with what they have regardless of what religious message is proffered. The book states that: the Dutch tended to cling tightly to their traditions (64); there is a well-established Catholic tradition in Italy (107); families, friends, and the Catholic Church combine forces to oppose the Church in Spain (108); and in Thailand devotion to king, country, tradition, and religion form a seamless whole (368). Missionaries constantly ply through this majority to find the scattered few who are searching for something better.

There are some sloppy errors. The book states there are two missions in Czechoslovakia, but the situation is that one mission covers a country that split into two nations (120). The Mormon Tabernacle Choir did not sing in Hungary in 1982 but toured only in Scandinavia that year (120). In four instances, years were incorrectly stated: 1946 in place of 1846 (144), 1847 rather than 1857 (156), 1836 instead of 1936 (252), and 1978 when 1968 was correct (369). A surprising omission is any mention of the modern history of the Church in Armenia though it has the highest membership of any country in the Middle East (442).

This volume is the most comprehensive collection of information on the international Church. As such it fulfills an important role in the historiography of the Church but it is just a beginning in the attempt to understand and measure the success of the Church in fulfilling its divine mandate to present the gospel message in all nations.

KAHLILE B. MEHR {mehrkb@ldschurch.org} is a past council member of the Mormon History Association, currently a member of the *Journal of Mormon History* executive committee, and author of *Mormon Missionaries Enter Eastern Europe* (Salt Lake City: Deseret Book/Provo, Utah: BYU Press, 2002).

---

Scott H. Faulring, Kent P. Jackson, and Robert J. Matthews, eds. *Joseph Smith's New Translation of the Bible: Original Manuscripts*. Provo, Utah: Religious Studies Center, Brigham Young University, 2004. ix, 851 pp. Photographs, notes, tables. Cloth: \$99.95; ISBN 1-59038-328-1

*Reviewed by H. Michael Marquardt*

*Joseph Smith's New Translation of the Bible: Original Manuscripts* is a large scholarly book presenting for the first time a typographic transcription of the handwritten pages, notes, and markings of the original manuscripts of the revision of the King James Version of the Bible made by Joseph Smith in the early 1830s. The book includes two useful charts, one giving the dates when the Joseph Smith Translation was worked on and the other a page-by-page listing of the manuscripts and scribes. A number of color photographs are included to illustrate what some of the manuscript pages look like.

Joseph Smith did not have the opportunity to publish the new translation during his lifetime. It was first published in 1867 under the title *The Holy Scriptures, Translated and Corrected by the Spirit of Revelation, by Joseph Smith, Jr., the Seer* by the Church of Jesus Christ of Latter-Day Saints.<sup>1</sup> Members of the publication committee included Joseph Smith III (church president), Israel L. Rogers, and Ebenezer Robinson. This work is available only in the English language.

The subtitle "Inspired Version" is the term applied to the printing of the *Holy Scriptures* since 1936. "Inspired Version" is used throughout this book. When used in 1936, the term gave the impression that other versions could be considered less inspired. The 1979 LDS edition of the King James Bible refers to Joseph Smith's Bible revisions as the Joseph Smith Translation (JST). This King James edition is the official LDS English version. In addition to footnotes citing the JST, the 1979 edition contains a seventeen-page appendix with JST extracts to supplement the KJV text.

The book contains five essays before the actual manuscript transcrip-

---

<sup>1</sup>In 1872 this church was incorporated as the Reorganized Church of Jesus Christ of Latter Day Saints, its official and legal name, with a shortened name change in April 2001 to the Community of Christ.

tion. The first essay presents a historical overview and surveys the types of changes that occur in the Bible revision. The first paragraph mentions that the restoration of the gospel “included the restoration of biblical doctrine that had been either removed, distorted, or simply misinterpreted by a world that did not enjoy the fulness of the gospel” (3). The editors maintain that the Bible revision was a translation “though it did not involve creating a new rendering from Hebrew or Greek manuscripts” (8).

In explaining the different types of changes made in the JST, besides the possible restoration of original text (category 1), the editors state: “The changes identified in categories 2 through 5 are not restorations of original text but are wording that likely had never been in the Bible, had never been written in Hebrew or Greek, and had never been cast in the ancient literary style of Bible writers” (11). They continue, “Because some JST passages were perhaps never in the Bible, we would not expect to find evidence for them in ancient manuscripts, no matter how close in date those manuscripts are to the original biblical texts.” This type of reasoning may indicate that those who study the JST just need to embrace it and not worry about being able to pin down the text. But notice the tentative nature of “perhaps.” On the other hand, scholars have located and translated additional manuscripts and papyri, enabling us to identify more accurately the biblical text.

One problem with the idea that the JST contains material never written in the ancient manuscripts is that a person cannot “restore” words that were never in the text in the first place. The pattern of many of Joseph Smith’s additions is consistent with the Book of Mormon’s claim that many “plain and precious” teachings had been removed (LDS 1 Ne. 13:28; RLDS 3:171).

The second essay is on “The New Translation and Latter-day Saint Doctrine.” It goes into the doctrinal aspect of the revision. The editors claim that the JST has been “ignored by some LDS scripture scholars and historians” and that some students “have not regarded it as a translation at all, nor even as a serious biblical document” (17). This appears to be correct as it may have a non-scriptural status shared with such manuscripts as the Egyptian Alphabet and related papers produced in 1835. Those reluctant to accord it scriptural status may see his emendations as part of Joseph Smith’s theological and doctrinal development.

The third essay by Ronald E. Romig, Community of Christ Archivist, presents a concise history of the original manuscripts after Joseph Smith’s death in 1844. He also discusses the 1828 marked King James Bible that was the basis for the English text of the revision.

The fourth essay describes the various scribes: Oliver Cowdery, John Whitmer, Emma Smith, Sidney Rigdon, Frederick G. Williams, and an unknown scribe (Scribe A). Joseph Smith wrote on four pages in the Old Testa-

ment portion of the manuscript.

The fifth and final essay tells about the transcription methods the editors used in making the printed transcription from the original manuscripts. Good introductions are provided for each manuscript.

The handwriting of the manuscripts sometimes is hard to read. To the editors' credit, this book presents a reliable transcription. One possible error could be in Luke 6:26 where a word is transcribed as "evill" (381) but is probably "well."

The student should be aware that the manuscripts of the JST contain many misspelled words. Just because a word is misspelled does not mean that it is a purposeful revision. Matthew 15:2 (KJV) has "tradition of the elders" while New Testament (NT) 2 has "tradition of the elder." In this case the KJV and NT 1 should be followed.

Even in the original dictation, verses were omitted either by accident or on purpose when reading from the Bible. Sometimes a verse would be added back in when the manuscript was compared with the KJV and the missing verses were located. The language of the KJV was updated.

Joseph Smith started his revision with Genesis, then revised Matthew through Revelation. Afterward he returned to Genesis and worked through Malachi. Over a period of three years (1830–33), Joseph revised and reviewed the manuscripts. The editors show that the initial New Testament work was completed in July 1832. Afterward Joseph Smith had additional notes and revisions made as he reviewed the manuscript pages.

This revision shows Joseph Smith's theological understanding of the Bible in the early years of his ministry. It was his next major endeavor after the Book of Mormon. While the Old Testament (OT) revision began in New York, Smith did the majority of the work while he was living in Kirtland and Hiram, Ohio. The time frame corresponds to Joseph Smith's revelations and instructions contained in the Doctrine and Covenants (LDS D&C 20, 24–93, 95–96; RLDS D&C 17, 23–90, 92–93).

There are four main manuscripts of the JST, some containing copied material. New Testament manuscript 2 contains four gatherings or folios. Two folios start with page 1. The following chart shows the division of the original manuscripts from which the transcription was taken:

<i>Old Testament</i>	<i>New Testament</i>
OT 1 (61 pages)	NT 1 (63 pages)
OT 2 (119 pages)	NT 2, folio 1 (pages 1–49)
	NT 2, folio 2 (pages 1–48)
	NT 2, folio 3 (pages 49–42)
	NT 2, folio 4 (pages 93–154)

The manuscript for NT 2, folio 4, pages 115–54 (John 6 through Revelation 22) shows that Joseph Smith and his scribe developed a quicker method than writing out the complete text. Markings were made in the Bible to indicate where passages needed to be changed. Some of the crossed-out words or markings were to be used in connection with the handwritten manuscript while other corrected verses were to be made without reference to the manuscript text. The manuscript for OT 2 was written out in full for Genesis 1:1–24:67. The remaining chapters of Genesis through Malachi also used the short method of recording changes.

Unknown to the reader since its first publication in 1867 is that Joseph Smith considered a large portion of the Old Testament as correct. Out of 929 chapters in the Old Testament over 45 percent were listed as correct after making minor revisions in the marked Bible.

The 1867 Bible included entire chapters and books as though the text was contained in the original manuscripts. For example, Joseph Smith wrote on OT 2 “Correct” for Nehemiah 11–13, Esther 1–10, and Job 3–42 but crossed out words within those chapters on his printed Bible. The 1867 edition reproduced the KJV text with no notation that the manuscript indicated the chapters were correct. In addition, markings in the printed Bible were made in Ecclesiastes as proposed changes, although the name of the book was not recorded on OT 2.

Smith considered Ruth, Lamentations, Micah, Nahum, Habakkuk, Zephaniah, Haggai, and Malachi correct, but the reader of the 1867 Bible has no idea that this was the case. Besides chapters listed in the OT 2, other chapter numbers were simply omitted. For example, Proverbs 23–31 were not recorded on the manuscript. There is no indication that the omitted chapters should not be included in the revision. Also Ecclesiastes was not listed in OT 2, but the marked Bible contains proposed changes for the revision. This shows the incomplete nature of Old Testament revisions and problems using the 1867 and other printings of the JST. The transcription in *Joseph Smith’s New Translation of the Bible* has listed those books and chapters considered by Smith as correct.

*Joseph Smith’s New Translation of the Bible* includes small photographs of many KJV verses that contain crossed-out words or that were otherwise marked. The editors explain: “We have provided a photograph of each verse in Joseph Smith’s Bible for which he made a change on the manuscripts” (54; also 455, 668). They list a few exceptions including Psalms 119:127 (668, 780); John 8:6 (455, 458); and Acts 24:8 (455, 474). A footnote states, “We do not even know if all the lined-out italics found in the Bible today can be attributed to Joseph Smith” (423, footnote 7). Further examination shows that the marked passages of Job 2:3 and 6:29 are included (738) but photographs of some additional cross-outs were omitted—for example, Job 13:2; 18:12;



19:25–26. Joseph Smith worked on these chapters and they contain cross-outs but he or his scribe labeled them as “Correct” (741).

While having access to these photographs improves our understanding of how the short method was used, it is not complete. Photographs of many of the marked verses have been omitted from both the Old and New Testaments. In the Bible, sometimes italic words are crossed out and the text is then considered correct. When Joseph Smith wrote that a chapter was correct, sometimes minor hand-made corrections have been made in the KJV Bible. Stephen Knecht pointed this fact out many years ago, indicating that hundreds of marked changes in Joseph Smith’s KJV Bible have not been printed.<sup>2</sup> This is a large omission in the new book.

The first two essays by LDS scholars take the perspective that Joseph Smith was justified in altering the Holy Scriptures. (Romig’s essay does not address the topic.) They cite the “plain and precious” passage, thus virtually mandating additions (as “restorations”) to the Bible.

Joseph Smith’s revision of the Bible was continually being revised in the 1830s. Smith was always learning and projecting his views in everything he did. There seems to be a great push to elevate the JST to canonization. The editors suggest it when they write that Latter-day Saints “can embrace it as they do the Book of Mormon, the Doctrine and Covenants, and the Pearl of Great Price” (11; see also 13, 25). If this were to occur, it would give the Church more of Joseph Smith and less of biblical writers. It would also create a barrier to outsiders rather than act as a bridge to a common understanding of the Bible.

The additional material that Joseph Smith inserted into the text is not in any other English version of the Bible. There are no biblical manuscripts (either Hebrew or Greek) that include Smith’s additions. At present, the LDS Church’s position is that the JST “restore[s] truths to the Bible text that had become lost or changed since the original words were written.”<sup>3</sup>

*Joseph Smith’s New Translation of the Bible* does not discuss omitted verses. For example, in Mark 13 (KJV), four verses in a row (33–36) do not appear in the JST. The reason is that Joseph Smith did not alter this chapter but used his prior revision of Matthew 24 for the text. To their credit, the editors mention that the Matthew 24 revision was used in composing Mark 13:

<sup>2</sup>Stephen R. Knecht, *The Story of Joseph Smith’s Bible Translation: A Documented History* (Salt Lake City: Associated Research Consultants Publication, 1977), 57a, 58, 66, 213–32.

<sup>3</sup>“Joseph Smith Translation,” in “Study Aids,” *The Scriptures: CD-ROM Resource Edition* [2004]; also on the official LDS Church website at <http://scriptures.lds.org/jst/contents>.

In the Bible, Matthew's account of Jesus' great discourse to the Twelve on the Mount of Olives (Matthew 24) is much longer and more detailed than Mark's (Mark 13). Both were changed significantly in the Joseph Smith Translation.

A comparison of the Matthew and Mark accounts in the New Translation shows that when Joseph Smith and his scribe arrived at Mark 13, the Prophet decided to copy the corrected Matthew account from NT2.1 rather than to revise the existing verses in Mark. (303-4)

In a few cases, Joseph Smith used as his standard text Book of Mormon passages, not those from the Bible. For example, he added to Genesis 50 the passage about a latter-day seer and to Isaiah 29 the coming forth of the Book of Mormon. The editors' introduction to OT 2 suggest that a retranslation of Isaiah 29 was unnecessary: "It appears, therefore, that when Joseph Smith came to that chapter in his translation of the Bible, he copied it from Nephi's record in the printed Book of Mormon rather than providing a new translation. If this was the case, then Nephi's inspired recording of the chapter and Joseph Smith's inspired translation of it into English were sufficient for the Lord's purposes and made a retranslation unnecessary" (589-90).

In the NT 1 version of the Sermon on the Mount from Matthew, a portion of the wording also comes from the Book of Mormon.<sup>4</sup> The inclusion of Book of Mormon passages indicates how Smith perceived his work on the Bible.

There is a close relationship between the revelations in the Doctrine and Covenants and the revision. For example, the topic of the gathering of the Saints is included as an addition to Luke 17:37 (414). The Bible text was final unless further alterations were made at a later time. Also Joseph Smith's new translation appears to include his early view concerning God. For his revision of Luke 10:22, Smith dictated "that the son is the Father, and that the Father is the son" (393).

New information is included in *Joseph Smith's New Translation of the Bible* concerning the handwriting of the scribes. Frederick G. Williams inserted words in Genesis, John, Acts, Romans, and 1 Corinthians. Sidney Rigdon wrote a short revision of Jeremiah 18:8, 10, and 14. An unknown scribe's handwriting appears on part of NT 2, folio 4, pp. 136, 139-42, 147-49.

Oliver Cowdery changed and corrected the ages of patriarchs in Genesis after the original dictation making Adam and Methuselah a thousand

---

<sup>4</sup>Richard P. Howard, *Restoration Scriptures: A Study of Their Textual Development* (Independence: Herald Publishing House, 1969), 98; (2nd ed. rev. and enlarged, 1995), 84.

years old. This change does not appear in the copied OT 2 but rather in the dictated manuscript. Neither the book of Moses nor the JST contains these age changes. Notes pinned to manuscript pages are in the handwriting of Sidney Rigdon, Joseph Smith, and Frederick G. Williams. There are also changes on manuscript pages by other individuals. For example, the words “and worthy” are added above the line for Matthew 26:66 but without a footnote (309). According to an article co-authored by Kent Jackson the handwriting is that of Joseph Smith III.<sup>5</sup>

The manuscripts show interesting layers of reworking the text as Joseph Smith refined his perception on particular passages. The interested student of the text will need to make his or her own evaluation in studying the transcriptions. Having *Joseph Smith’s New Translation of the Bible* with its transcription of the original manuscripts is a step in the right direction in providing these writings to researchers and scholars of the Restoration movement. We should keep in mind that Joseph worked on the Bible in the earliest stage of his ministry but was unable to complete and publish the work as he planned.

Does it merit canonization? I lean toward the position of Kornelis (“Kees”) Compier, currently European Mission Center Financial Officer, Community of Christ, who wrote in the conclusion to his study of the Gospel of Mark: “Joseph’s New Translation should be considered a historical document representing its own time. Both the Reorganized Church of Jesus Christ of Latter Day Saints and other churches using Joseph’s New Translation should consider this document as representing a certain phase of their church history and move on to and recommend the use of newer and better translations of the Bible.”<sup>6</sup>

I agree that the JST should be recognized as Joseph Smith’s studied ideas about the KJV during 1830–33, made independently of biblical scholarship and during an early phase of his theological development. Many nineteenth- and twentieth-century biblical scholars have provided more accessible translations of the KJV for modern readers.

This new book is an important research tool and is a good step in providing scholars and interested persons with a readable, though not totally

---

<sup>5</sup>See Kent P. Jackson and Peter M. Jasinski, “The Process of Inspired Translation: Two Passages Translated Twice in the Joseph Smith Translation of the Bible,” *BYU Studies* 42, no. 2 (2003): 55.

<sup>6</sup>Kornelis Compier, “Joseph Smith’s ‘New Translation’ and Its Effect upon the Interpretation of the Text in the Gospel of Mark” (Thesis project, Iliff School of Theology, Denver, Colorado, 1988), 96; copy in Community of Christ Library-Archives.

---

comprehensive, transcription of these important manuscripts. I would recommend this book for those who are researching this aspect of Joseph Smith's ministry.

H. MICHAEL MARQUARDT {research@xmission.com}, an independent historian and research consultant, is the author of *The Joseph Smith Revelations: Text and Commentary* (Salt Lake City: Signature Books, 1999).

GUIDE AND INTERPRETER TO  
THE MORMON BATTALION

# SACAGAWEA'S CHILD

The Life and Times of  
Jean-Baptiste (Pomp) Charbonneau

BY SUSAN M. COLBY

With Lewis and Clark from birth, little "Pomp" journeyed to the Pacific in the arms of his mother, Sacagawea. In his sixty-one years, Jean-Baptiste Charbonneau successfully integrated the *voyageur* lifestyle of his father's people, the proud Native American heritage of his mother's people, and the great Jeffersonian traditions of his guardian, William Clark.

Jean-Baptiste remained at the forefront of western expansion his entire life—from his infancy with the Corps of Discovery to his years as a fur trader and Mountain Man. He later served as guide and interpreter to Philip St. George Cooke and the Mormon Battalion in their epic 1846 march to California, and went on to work in the gold country before dying in Oregon en route to Montana Territory. Here is a study of a unique American *métis* and the cultures and times that molded him.

*A handsome volume of 203 pages, containing a chronology, notes, biblio., appendix, and index. Embellished with 20 illustrations and maps. Bound in rich red linen cloth with foil-stamped spine and front cover. Western Frontiersmen Series, vol. 33.*

\$28.50

Library of Congress Control Number 2004027793 ISBN 0-87062-339-7

THE ARTHUR H. CLARK COMPANY  
info@ahclark.com · www.ahclark.com · (800) 842-9286

## The Mormon Colonies in Mexico

Thomas Cottam Romney

Unavailable since its original publication in 1938, this important document of a little-known chapter in Mormon history is now reprinted with a new introduction by Martha Sonntag Bradley.

"Romney's unique vantage point is the strongest draw of this narrative: Romney and his family lived much of their life in the Mexican Mormon colonies. But the narrative's value is much broader and deeper than just that. Romney's insights into Mexican politics and personalities, and his view of the course of history from inside rather than from outside, are fascinating, colorful and opinionated. He was clear about who he admired and why, and who he did not."

—from the Introduction



The Mormon Colonies in Mexico

Thomas Cottam Romney  
Reprinted by Standing Sentinel Press

14 photographs, 1 map  
Paper \$19.95

## Camp Floyd and the Mormons

The Utah War

Donald R. Moorman  
with Gene A. Sessions

First published in 1992, this reprint edition includes a new introduction by Gene Sessions in which he recounts Moorman's research adventures during the 1960s "in the bowels of the old Church Administration Building, where Joseph Fielding Smith and A. Will Lund watched over the contents of the archives like wide-eyed mother hens."

"Moorman's epic account of the federal army's march to Utah and its activities at Camp Floyd until the eve of the Civil War is a balanced study in the best tradition of good historical scholarship."

—Allan Kent Powell, Utah State Historical Society

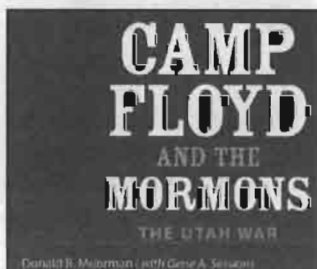

36 illustrations  
Paper \$19.95

The University of Utah Press

(800) 621-2736 ~ Order online from [www.UofUPress.com](http://www.UofUPress.com)

# Southern Utah University Press Acquires New Book

## Westward America

By Howard R. Driggs

Illustrated by William H. Jackson

Published in 1942

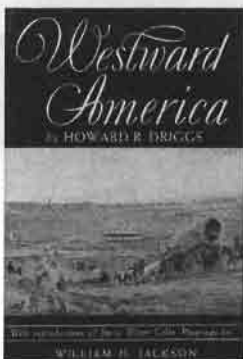

Forty full-page, full-color reproductions illustrate the forty stirring chapters of *Westward America*.

Limited copies of the original edition still in slipcase.

Collector's Edition - \$75

Deluxe Edition - \$125

## *Historical Topography: A New Look at Old Sites on Mountain Meadows* by Morris A Shirts and Frances Anne Smeath

This book sheds light on the physical location of the wagon train members: where they camped, where they were attacked, where they were killed, where they were buried and what marks their grave.

A must read for those interested in Mountain Meadows.  
\$15.00 softbound



To purchase these and other books check online at  
[http://proxy.li.suu.edu/CFIDE/suupress/browse\\_books.cfm](http://proxy.li.suu.edu/CFIDE/suupress/browse_books.cfm)  
or send your check to

SUU Press at the Sherratt Library

351 W. University Blvd. Cedar City, UT 84720

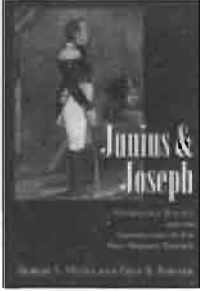

## Junius and Joseph

*Presidential Politics and the Assassination of the First Mormon Prophet*

ROBERT S. WICKS and FRED R. FOISTER

A thorough reexamination of Joseph Smith Jr.'s presidential candidacy, his murder at Carthage, and the possible connections between them.

\$24.95 paper; \$45.95 cloth

## Women in Utah History

*Paradigm or Paradox?*

EDITED BY LINDA THATCHER and  
PATRICIA LYN SCOTT

A project of the Utah Women's History Association providing the first thorough survey of the complex history of Utah's diverse women.

\$26.95 paper; \$48.95 cloth



## The Mormon Vanguard Brigade of 1847

*Norton Jacob's Record*

EDITED BY RONALD O. BARNEY

Widely regarded as one of the most detailed and valuable eyewitness accounts, Norton Jacob's record tells the story of Brigham Young's pioneer company from the perspective of a rank and file member.

\$22.95 paper; \$44.95 cloth

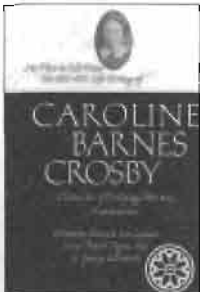

## Life Writings of Frontier Women, Volume Seven

### No Place to Call Home

*The 1807-1857 Life Writings of Caroline Barnes Crosby, Chronicler of Outlying Mormon Communities*

EDITED BY EDWARD LEO LYMAN,  
SUSAN WARD PAYNE, and  
S. GEORGE ELLSWORTH

\$32.95 cloth



**UTAH STATE UNIVERSITY PRESS**

7800 OLD MAIN HILL • LOGAN, UTAH 84322

WWW.USU.EDU/USUPRESS • 1.800.621.2736



# The Rise of Mormonism: 1816–1844

By H. Michael Marquardt

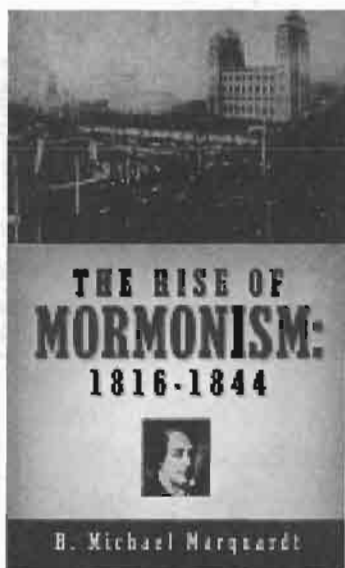

Here is an open, honest, and refreshing history of the foundational years of the Latter-day Saints restoration movement. You may have heard that Joseph Smith was the prophet of Mormonism. But do you know the story behind the gold plates? This book examines the background, evolution, conflicts, and sacrifices made by church members. Primary sources are used cover a twenty-five-year period of history. This book covers before the establishment of the church and during Joseph Smith's fourteen-year ministry. If you want to know the history and basis for every church whose teachings go back to the *Book of Mormon* this is the book. Read from the records of the day.

**H. MICHAEL MARQUARDT** is an independent historian and a longtime research consultant of the Latter-day Saints (Mormons). He has been publishing on Mormonism for more than thirty years. He is the author of *The Joseph Smith Revelations: Text and Commentary* (Salt Lake City: Signature Books, 1999).

History/Comparative Religions  
Footnotes, Bibliography, Index  
6x9 696 pages  
Xulon Press

Editions:	ISBN:	US Price:
Paperback	1597814709	\$29.99
Hardcover	1597814717	\$43.99

To order in US call toll free 1-866-909-2665 or visit  
[www.xulonpress.com](http://www.xulonpress.com)



### **GOLD RUSH SAINTS**

CALIFORNIA MORMONS AND THE  
GREAT RUSH FOR RICHES

By Kenneth N. Owens

In *Gold Rush Saints*, Kenneth N. Owens presents first-person accounts of pioneer Mormons, both men and women, to offer new perspectives on the myths and realities of gold rush California.

\$19.95 PAPER | 0-8061-3681-2 | 400 PAGES



### **THE OATMAN MASSACRE**

A TALE OF DESERT CAPTIVITY AND SURVIVAL

By Brian McGinty

Following a prophecy, Roys Oatman, a dissident Mormon, led his family and a few others on a journey west. Brian McGinty explores the background, developments, and aftermath of the Oatman massacre, one of the most famous and dramatic captivity stories of the Southwest.

\$27.95 CLOTH | 0-8061-3667-7 | 288 PAGES



### **BLOOD OF THE PROPHETS**

BRIGHAM YOUNG AND THE MASSACRE AT  
MOUNTAIN MEADOWS

By Will Bagley

This controversial book delves deep into the massacre at Mountain Meadows in Utah on September 11, 1857—the single most violent act to occur on the overland trails—and uncovers divisive findings about the Mormons and their leader, Brigham Young.

\$24.95 PAPER | 0-8061-3639-1 | 544 PAGES



UNIVERSITY OF OKLAHOMA PRESS

2800 VENTURE DRIVE • NORMAN, OKLAHOMA 73069-8216

TEL 800 627 7377 • FAX 800 735 0476 • OUPRESS.COM









MORMON HISTORY ASSOCIATION  
C/O LARRY AND ALENE KING  
581 SOUTH 630 EAST  
OREM, UTAH 84097

NON-PROFIT  
U.S. POSTAGE PAID  
SALT LAKE CITY  
UTAH 84119  
PERMIT NO 993

ISSN 0094-7342