

## REPORT No. 451

### THE DRAG OF TWO STREAMLINE BODIES AS AFFECTED BY PROTUBERANCES AND APPENDAGES

By IRA H. ABBOTT

#### SUMMARY

*Two airship models were tested in the N. A. C. A. variable-density wind tunnel to determine the drag coefficients at zero pitch, and the effect of fins and cars and of flat and streamline protuberances located at various positions along the hull. During the investigation the stern of one model was rounded off to produce a blunter shape. The extreme range of the Reynolds Number based on the over-all length of the models was from 1,300,000 to 33,000,000.*

*At large values of the Reynolds Number the streamline protuberance affected the drag very little, and the additional drag caused by the flat protuberance was less than the calculated drag of the protuberance alone. The fins and cars together increased the bare-hull drag about 20 per cent.*

#### INTRODUCTION

The National Advisory Committee for Aeronautics is conducting in the variable-density wind tunnel an extensive investigation of aerodynamic interference. The investigation deals in part with the effects of protuberances from the surfaces of otherwise streamline bodies. Tests have been made (reference 1) to study the effects on the characteristics of wings and airfoil sections of protuberances from the surface of an airfoil. The part of the investigation dealt with in this report is the study of the interference of protuberances from the surfaces of streamline bodies of revolution.

The desirability of making such interference tests in the variable-density wind tunnel where large values of the Reynolds Number may be obtained is apparent from consideration of the boundary-layer theory. (Reference 2.) If wind-tunnel tests of airship models are made in the usual range of relatively small Reynolds Numbers where neither the laminar nor the turbulent condition of the boundary layer is predominant, the type of flow existing in the boundary layer over a large portion of the surface is dependent upon the turbulence of the air stream. The drag coefficients thus obtained have no simple relation to the full-scale coefficients; in fact, those obtained for the same model at the same Reynolds Number but in different wind tunnels vary greatly. (References 2 to 6.) If a

protuberance is attached to a model tested in this range of Reynolds Numbers, the additional turbulence created by the protuberance may cause the line of transition between the laminar and turbulent boundary layers to move upstream with a resulting increase in the drag coefficient. The nature of the interference between the body and the protuberance in this case is obviously different than that which occurs when the boundary layer is almost completely turbulent. The data obtained at large values of the Reynolds Number in this investigation are accordingly expected to be more applicable than those previously obtained at small values of the Reynolds Number to the solution of design problems, such as the determination of the drag of fittings, radiators, water-recovery apparatus, and other objects projecting from fuselages and airship hulls.

A study of the effects of protuberances was planned to be made during a previous investigation of the aerodynamic characteristics of airship models. (Reference 4.) The drag of the models, however, was found to vary with the surface roughness which, with the wooden models used in the investigation, could not be maintained constant under the conditions of temperature and pressure in the variable-density wind tunnel.

An attempt to measure the relatively small differences in drag due to protuberances was accordingly considered inadvisable. To obviate the difficulty the Goodyear-Zeppelin Corporation furnished a simplified metal model of the U. S. airship *Akron*. The tests on this model were delayed by extensive alterations of the variable-density wind tunnel. Meanwhile the U. S. Army Air Corps requested tests of a model of a proposed metal-clad airship. The two models were tested in January, 1931. The drag coefficients at zero pitch, and the additional drag due to flat and streamline protuberances, and to fins and cars were determined. The extreme range of Reynolds Numbers obtained in these tests was from about 1,300,000 to 33,000,000.

#### APPARATUS AND METHOD

The two airship models of aluminum alloy used in this investigation are designated models A and M, respectively.

Model A was a simplified model of the U. S. airship *Akron* with circular cross sections. The length of this model was 37.39 inches and the fineness ratio was 5.9. The measured ordinates are given in Table I. The surface of this model was very smooth. No fins and cars were furnished. During the investigation the stern of this model was altered to a blunter shape, the

During the course of the investigation the surface of this model was polished for a distance of 6 inches aft of the bow, and later was polished all over. This model was equipped with one control and four motor cars, and with two sets of tail surfaces, one set having six and the other eight fins. The arrangements of the fins and cars are shown in Figures 2a and 2b.

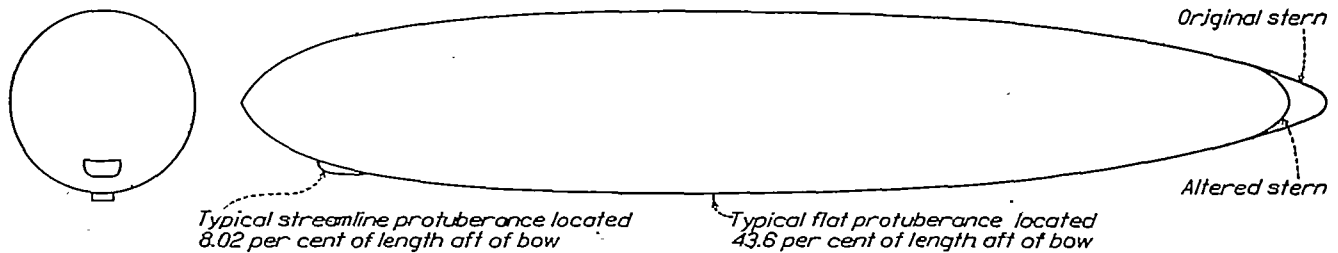
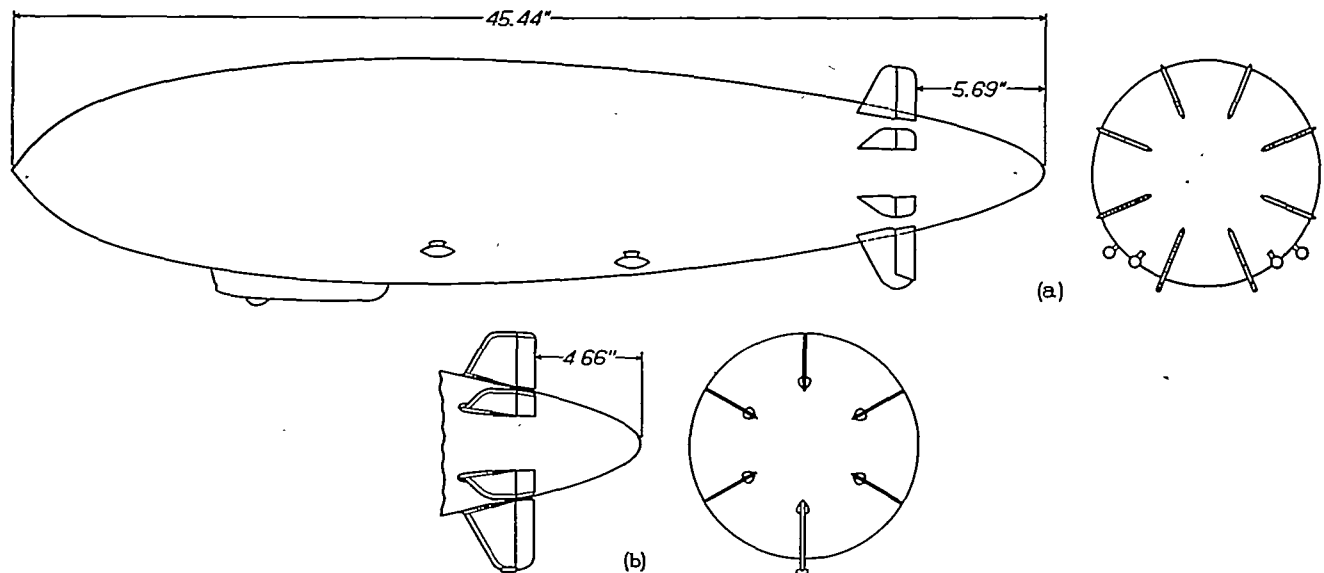

FIGURE 1.—Outlines of model A with original and altered sterns showing typical flat and streamline protuberances

ordinates of which are given in Table I. Figure 1 is an outline drawing of the model showing the two sterns.

Model A was tested with a flat-plate protuberance having a width of 11.8 per cent and extending 3.9 per cent of the maximum diameter of the model from the surface. This protuberance was successively attached to the model perpendicular to the surface at 8.02, 17.4, 30.7, 43.6 (near maximum ordinate), 63.5, and 82.2 per cent of the length of the model aft of the bow. Further tests were made with the flat protuberance faired to

The tests were made in the variable-density wind tunnel, which is described in reference 7. The mounting of the model on the auxiliary drag balance was similar to that described in reference 3, except that four partly shielded round wires were used to support the model instead of three streamline wires, and that a 45° linkage was used instead of a bell crank to transmit the force of a counterweight. Figure 3 is a photograph of model M mounted in the tunnel. The distances from the downstream edge of the entrance



FIGURES 2 a and b.—Outline of model M showing arrangement of fins and cars (a) 8 fins (b) 6 fins

form a streamline protuberance located successively at 8.02, 30.7, and 63.5 per cent of the length aft of the bow. The outlines of the protuberances in typical positions on the hull are shown in Figure 1.

Model M was a model of a proposed metal-clad airship. The length of this model was 45.44 inches and the fineness ratio was 4.5. The ordinates are given in Table II. This model had a machined surface showing very small circumferential tool or finishing marks.

cone to the bows of models A and M when mounted for tests were 12 and 10 inches, respectively.

The results were corrected for the drag of the support wires, the effect of the static pressure gradient along the axis of the tunnel, and the effect of the tunnel walls. The wire drag was computed (reference 8), and was checked by testing model A successively with two sizes of wires. The interference between the rear support wires and the fins of model M was found to be

negligible by testing this model with the rear support wires in two positions. The static pressure gradients were measured at all tank pressures (reference 7) for the determination of the horizontal buoyancy correction, which was computed for each pressure by a process of graphical integration. As this correction showed small inconsistent variations with tank pressure, an average correction was used for all pressures. The tunnel-wall correction was computed from the formulas given in reference 9.

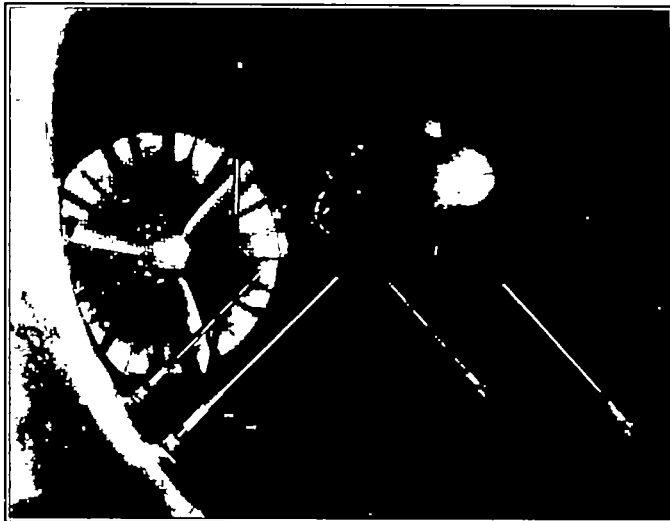

FIGURE 3.—Photograph of model M with fins and cars mounted for test in the variable-density wind tunnel

PRECISION

The variation in check points indicates the accidental error of the gross force measurements to be about ±1 per cent of the net bare-hull drag. The error of the balance calibration may be as large as ±2 per cent at the small Reynolds Numbers and ±1 per cent at the large ones.

The drag coefficients of model A as determined from successive tests with support wires 0.0155 and 0.0240 inch in diameter were the same within the accuracy of the tests. The precision of the tare-drag correction is accordingly believed to be within ±3 per cent of the net bare-hull drag. No reliable estimate of the error in the horizontal buoyancy correction can be made, but the result of this error is believed to be small because this correction was only about 5 and 10 per cent, respectively, of the net bare-hull drags of models A and M. The tunnel-wall correction was very small and the error in this correction is believed to be negligible.

Disregarding the error in the horizontal buoyancy correction, the possible error in the results is ±6 per cent. As the inaccuracies of corrections do not affect the precision of the values obtained for the additional drags of protuberances and appendages, these values

are believed to be precise to about ±1 per cent of the net bare-hull drags.

RESULTS AND DISCUSSION

The results are presented in the form of drag coefficients which are defined as  $C_D = \frac{D}{q(Vol.)^{\frac{2}{3}}}$  and are

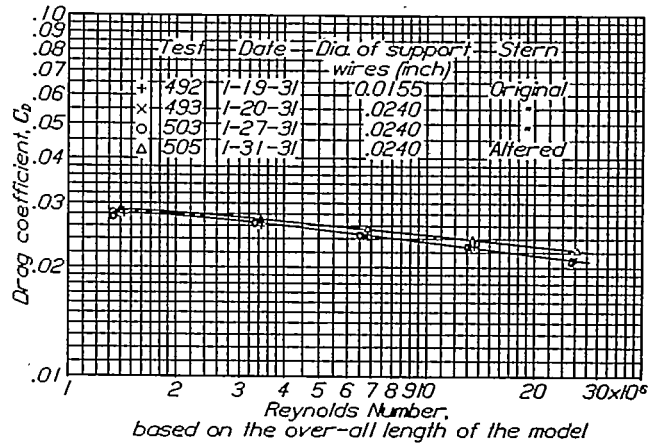

FIGURE 4.—Drag coefficients of model A

Tested in the N. A. C. A. variable-density wind tunnel. Volume=0.472 cu. ft. (Vol.)<sup>2/3</sup>=0.606 sq. ft. Length=37.39 in. Bare hull with original and altered sterns. Drag coefficient and Reynolds Number of altered model based on original volume and length. Results corrected for wire drag, horizontal buoyancy, and tunnel-wall effect.

plotted as functions of Reynolds Number. The Reynolds Numbers are based on the lengths of the models.

Bare-hull drags.—The bare-hull drags of models A and M are presented in Figures 4 and 5. The figures show that the curves of drag coefficients are nearly straight lines when plotted on logarithmic scales

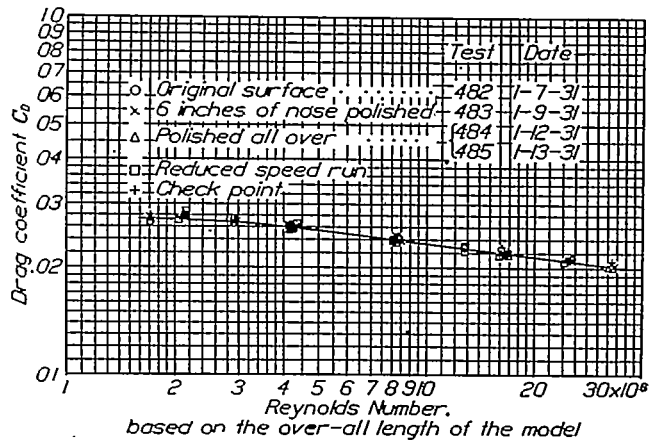

FIGURE 5.—Drag coefficients of model M

Tested in the N. A. O. A. variable-density wind tunnel. Bare hull. Volume=1.291 cu. ft. (Vol.)<sup>2/3</sup>=1.186 sq. ft. Length=45.44 in. Support wires=0.0240 in. dia. Results corrected for wire drag, horizontal buoyancy, and tunnel-wall effect.

against the Reynolds Number. It will be seen from Figure 5 that the drag coefficient of model M is the same, within the accuracy of the tests, at a given value

of the Reynolds Number irrespective of the combination of air speed and density used to give that Reynolds Number. A comparison of the results obtained for model A with those obtained for different models of the same airship in different tunnels is given in reference 10.

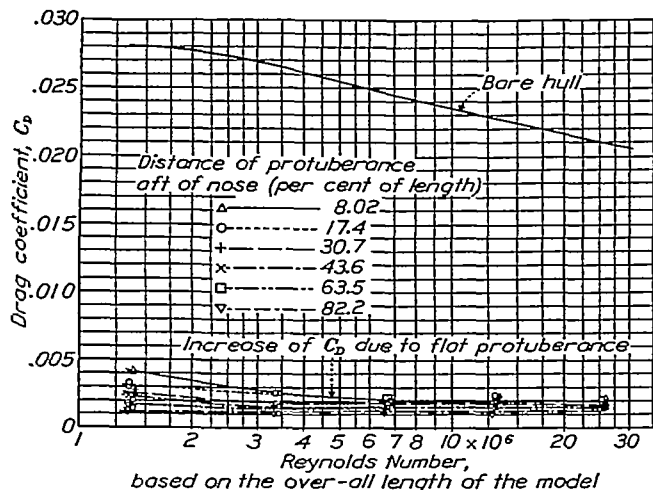

FIGURE 6.—The increase of drag coefficient of model A resulting from a flat protuberance located in various positions along the hull

**Effect of blunt stern.**—The drag coefficients of model A with the altered stern, which was considerably blunter than the original one (fig. 1), are presented in Figure 4. At the highest values of the Reynolds Number the drag is about 5 per cent higher with the altered stern than with the original one. It will be noticed that the rate of decrease of the drag coefficient with increasing values of the Reynolds Number is less for the model with the altered stern than for the original model.

**Effect of flat protuberances.**—The additional drag coefficients due to a flat protuberance located at various positions along the hull of model A are plotted against the Reynolds Number in Figure 6. At the highest values of the Reynolds Number the additional drag due to the protuberance in any position is less than the drag of the protuberance alone as calculated from flat-plate data. (Reference 11.) This fact indicates that at large values of the Reynolds Number any increase of drag resulting from the effect of the protuberance on the flow over the hull need not be considered.

Figure 6 shows a fairly consistent decrease in the additional drag due to the protuberance as its position varies from bow to stern. This variation is in the direction that would be expected, since the protuberance when located near the stern may be in a region of lower velocity than when located near the bow. It is interesting to note how well this effect can be predicted from boundary-layer and pressure-distribution data.

The apparent drag coefficients of the protuberance as located in the various positions have been calculated using the measured additional drags due to the protuberance, and the average dynamic pressures of the air streams in which the protuberance was placed. These average dynamic pressures were determined graphically from pressure-distribution and boundary-layer data obtained at a Reynolds Number of 18,000,000. (Reference 12.) The calculated drag coefficients of the protuberance are tabulated in Table III. As expected, these calculated coefficients show less variation with the position of the protuberance than the measured additional drags. The calculated drag coefficients of the protuberance are much lower than the usual flat-plate coefficients (reference 11), indicating the presence of favorable additional interference that was not considered in the above calculations. The values of the calculated drag coefficients of the protuberance apply directly only to flat-plate protuberances in contact with the hull, and may be considerably different from coefficients similarly obtained for flat plates near, but not in contact with, the hull.

**Effect of streamline protuberances.**—The additional drag coefficients due to streamline protuberances are plotted against the Reynolds Number in Figure 7 for three positions along the hull of model A. It will be noted that the additional drag due to these protuber-

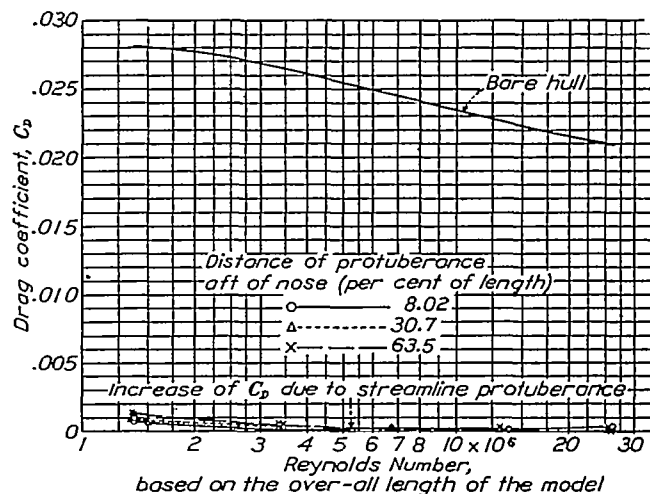

FIGURE 7.—The increase of drag coefficient of model A resulting from a streamline protuberance located in various positions along the hull

ances is very small at the high values of the Reynolds Number.

**Effect of fins and cars.**—The additional drag coefficients for each group of fins and of fins and cars on model M are plotted against the Reynolds Number in Figure 8. The increase of drag coefficients due to the six and eight fin groups is about 8 and 11 per cent, respectively, of the bare-hull drag. The low drag of the six-fin group was originally thought to be due to

interference between the fins and the rear support wires, which were located nearly in the planes of two of the fins. The tests were therefore repeated with the rear support wires moved, but the results checked those previously obtained.

No data are available to permit the computation of the average dynamic pressure of the flow over the fins; therefore the drag coefficients of the fins have been computed using the measured additional drag due to them, the dynamic pressure of the stream with no model present, and the fin areas. These drag coeffi-

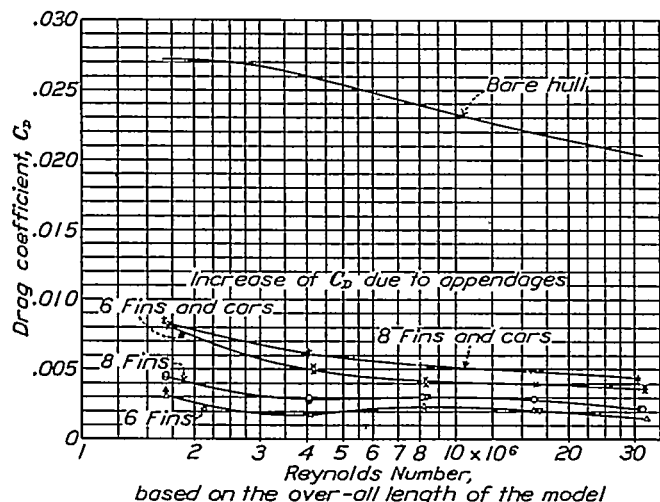

FIGURE 8.—The increase of drag coefficient of model M resulting from fins and cars

icients were found to be 0.0073 and 0.0088 for the six and eight fin groups, respectively, at the highest value of the Reynolds Number obtained. These values are approximately the same as the minimum drag coefficients of thin symmetrical airfoils. (Reference 13.) The fin sections, however, were not of good streamline form, and hence it is probable that there was a favorable interference effect.

The additional drag due to the cars with either set of fins at the highest values of the Reynolds Number was equal to about 10 per cent of the bare-hull drag. The drag coefficient of the cars based on the sum of their maximum cross-sectional areas and the dynamic pressure of the air stream with no model present has been computed from the measured additional drag due to the cars. This drag coefficient was about 0.12 at the largest values of the Reynolds Number obtained which were about 1,200,000 and 5,600,000 for the motor and control cars, respectively. This drag coefficient is about 50 per cent larger than that for good streamline bodies at the same Reynolds Numbers. (Reference 4.) Part of this difference may be due to interference between the hull and cars, but it is probable that the relatively poor streamline forms of the

cars as compared with the airship models of reference 4 accounts for most of the difference. It will be noted that there is an apparent error in the test at the lowest value of the Reynolds Number (fig. 8), because the results of this test show an appreciable difference in the additional drag due to the cars with the different sets of fins.

Effect of surface roughness.—The drag coefficients obtained for model M with its original surface, with the surface polished for a distance of 6 inches aft of the bow, and with the surface polished all over are plotted in Figure 5. The drag coefficients agree within the accuracy of the tests. The previous tests which showed large effects of surface roughness on the drag coefficient were made with models whose surfaces were much rougher than those of the present tests. (Reference 4.)

### CONCLUSIONS

The results reported in this paper are significant in showing that the addition to a streamline body of revolution of flat and streamline protuberances of the size tested does not result in adverse interference effects at large values of the Reynolds Number. Accordingly, no large adverse interference effects would be expected to result from variations of the shape of the protuberance. It is probable, however, that the removal of the protuberance from the hull to form a body or plate separated from the hull by a small gap would modify the interference to an appreciable extent.

LANGLEY MEMORIAL AERONAUTICAL LABORATORY,  
NATIONAL ADVISORY COMMITTEE FOR AERONAUTICS,  
LANGLEY FIELD, VA., September 26, 1932.

### REFERENCES

1. Jacobs, Eastman N.: Airfoil Section Characteristics as Affected by Protuberances. T. R. No. 446, N. A. C. A., 1932.
2. Dryden, H. L., and Kuethé, A. M.: Effect of Turbulence in Wind Tunnel Measurements. T. R. No. 342, N. A. C. A., 1930.
3. Higgins, George J.: Tests of the N. P. L. Airship Models in the Variable Density Wind Tunnel. T. N. No. 264, N. A. C. A., 1927.
4. Abbott, Ira H.: Airship Model Tests in the Variable Density Wind Tunnel. T. R. No. 394, N. A. C. A., 1931.
5. Millikan, Clark B.: The Boundary Layer and Skin Friction for a Figure of Revolution. Trans. A. S. M. E., Jan. 30, 1932, pp. 29-43.
6. Ower, E.: Interference. Jour. R. A. S., July, 1932, pp. 531-77.

7. Jacobs, Eastman N., and Abbott, Ira H.: The N. A. C. A. Variable-Density Wind Tunnel. T. R. No. 416, N. A. C. A., 1932.
8. De Foe, George L.: Resistance of Streamline Wires. T. N. No. 279, N. A. C. A., 1928.
9. Lock, C. N. H.: The Interference of a Wind Tunnel on a Symmetrical Body. R. & M. No. 1275, British A. R. C., 1929.
10. Freeman, Hugh B.: Force Measurements on a 1/40-Scale Model of the U. S. Airship Akron. T. R. No. 432, N. A. C. A., 1932.
11. Warner, Edward P.: Airplane Design, Aerodynamics. McGraw-Hill Book Co., 1927.
12. Freeman, Hugh B.; Measurements of Flow in the Boundary Layer of a 1/40-Scale Model of the U. S. Airship Akron. T. R. No. 430, N. A. C. A., 1932.
13. Jacobs, Eastman N.: Tests of Six Symmetrical Airfoils in the Variable Density Wind Tunnel. T. N. No. 385, N. A. C. A., 1931.

TABLE I

MEASURED ORDINATES OF MODEL A

Station, measured from bow	Ordinates	
	With original stern	With altered stern
Inches	Inches	Inches
0.000	0.000	0.000
.250	.414	.414
.500	.728	.728
1.000	1.167	1.167
2.000	1.752	1.752
4.000	2.394	2.394
6.000	2.744	2.744
8.000	2.963	2.963
10.000	3.083	3.083
14.000	3.187	3.187
18.000	3.179	3.179
22.000	3.071	3.071
26.000	2.826	2.826
30.000	2.304	2.304
32.500	-----	1.830
33.000	-----	1.717
33.500	-----	1.598
34.000	1.476	1.473
34.500	-----	1.344
34.750	-----	1.297
35.000	-----	1.173
35.250	-----	1.055
35.500	-----	.905
35.750	-----	.651
36.000	-----	.314
36.180	-----	.000
36.600	.658	-----
37.100	.421	-----
37.350	.204	-----
37.390	.000	-----

TABLE II  
MEASURED ORDINATES OF MODEL M

Station, measured from bow	Ordinates
Inches	Inches
0.000	0.000
.250	.402
.500	.728
1.000	1.201
2.000	2.123
4.000	3.123
6.000	3.745
8.000	4.194
10.000	4.513
12.000	4.738
14.000	4.838
18.000	4.992
22.000	4.907
26.000	4.654
30.000	4.239
34.000	3.679
38.000	3.336
38.000	2.949
40.000	2.496
42.000	1.966
43.000	1.643
44.000	1.258
44.500	1.002
44.750	.856
45.000	.691
45.250	.455
45.433	.000

TABLE III

DRAG COEFFICIENTS OF FLAT PROTUBERANCES ON MODEL A

$$C_{D_p} = \frac{D_p}{q_a S}$$

Where  $q_a$  is the average local dynamic pressure and  $S$  is the area of the protuberance  
Reynolds Number of model A based on the over-all length of the model, 18,000,000

Location of protuberance, per cent of length of model A aft of nose	$C_{D_p}$
8.02	0.83
8.02	.84
17.4	.84
17.4	.84
30.7	.75
30.7	.75
43.6	.75
43.6	.70
63.5	.79
63.5	.79
63.5	.70
63.5	.75
82.2	.75
82.2	.75