

The effect of alternative fuels on gaseous and particulate matter (PM) emission performance in an auxiliary power unit (APU)

B. Khandelwal, J. Cronly, I.S. Ahmed, C.J. Wijesinghe and C. Lewis

Low Carbon Combustion Center
The University of Sheffield
UK

ABSTRACT

There is a growing interest in the use of alternative fuels in gas turbine engines to reduce emissions. Testing of alternative fuels is expensive when done on a large-scale gas turbine engine. In this study, a re-commissioned small gas turbine auxiliary power unit (APU) has been used to test various blends of Jet A-1, synthetic paraffinic kerosene (SPK) and diesel with as well as eight other novel fuels. A detailed analysis of performance, gaseous emissions and particulate emissions has been presented in this study. It is observed that aromatic content in general as well as the particular chemical composition of the aromatic compound plays a vital role in particulate emissions generation. SPK fuel shows substantially lower particulate emissions with respect to Jet A. However, not all the species of aromatics negatively impact particulate emissions. Gaseous emissions measured are comparable for all the fuels tested in this study.

Keywords: Emissions, Gas Turbines, Particulates, Fuel

1.0 INTRODUCTION

There is a growing interest in decreasing the net emissions produced by gas turbines. This has led to research and development towards operating gas turbines using alternative fuels. The driving factors for this increased interest towards alternative fuels and decreasing emissions comes from rising fuel cost⁽¹⁾, decreasing crude oil resources and increasing environmental consideration^(2–4). There is also a growing concern about local air quality around airports, and steps are being taken by industry to reduce emissions. The aviation industry is growing at a rate of approximately 4% each year and is predicted to rise at this rate for decades to come⁽¹⁾. It is estimated that aviation currently accounts for about 3% of total global warming gases produced and is therefore continuously rising due to growth in the aviation industry. Alternative fuels derived by the Fischer-Tropsch (F-T) process from biomass, coal and gas draw an interest by researchers and industry due to their drop-in capability i.e. no engine

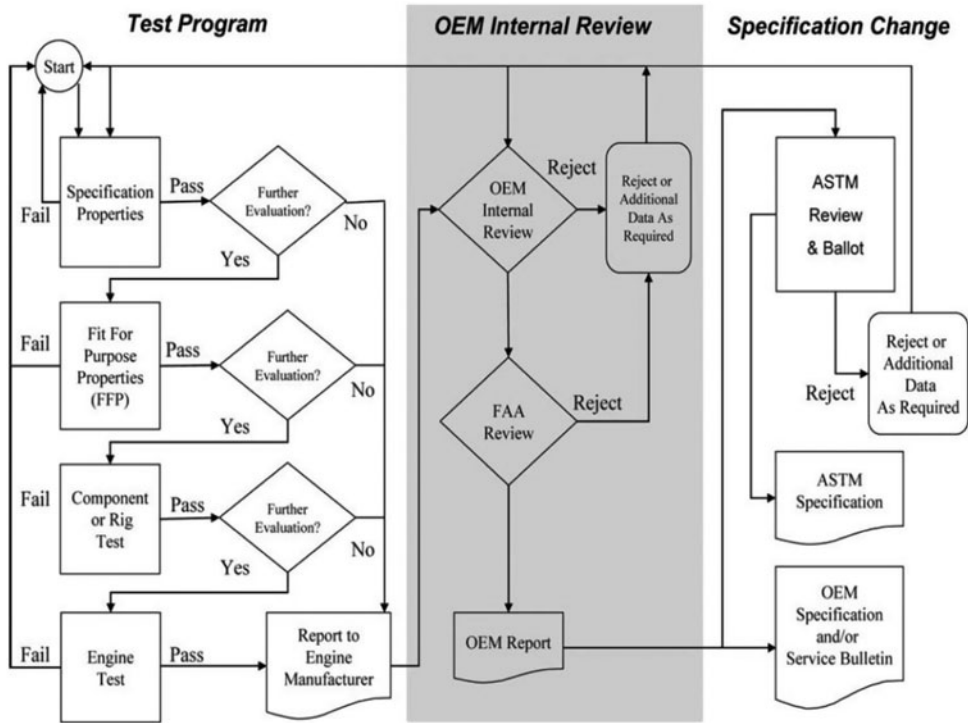

Figure 1. Flowchart of the approval process for new aviation turbine fuels⁽¹¹⁾.

modification required⁽⁵⁾. Another reason for this interest is to improve the security of energy supply as alternative fuel sources can be obtained domestically.

While oil shale and F-T fuels offer increased energy security, bio-derived fuels are renewable and claimed to reduce carbon emissions in their life cycle⁽⁶⁾. F-T fuels can be derived from a wide range of feedstocks such as natural gas, used cooking oil (UCO), fuel crops, coal, etc. F-T fuels have the potential to provide better combustion properties and lower emissions. Fuel derived from oil shale, gas and coal are non-renewable sources of fuels, but are readily available and viable as these are obtained using existing technologies. Commercial production of fuel from shale, gas and coal has been accomplished in several countries to date. In 1999, Sasol produced a semi-synthetic jet fuel (SSJF), which was a blend of up to 50% of synthetic fuel made from coal by F-T synthesis and conventional jet fuel. From that time onwards SSJF has been supplied to the Johannesburg Airport, South Africa, for use for gas turbines⁽⁷⁾.

According to present regulations, restrictions placed on commercial flights on the use of alternative fuels are stringent. This is due to economic and logistic issues and partly to provide safe and reliable fuel that can perform in the arduous conditions in which gas turbines work⁽⁸⁾. Since the aviation industry tends to keep its assets for around 40 years⁽⁹⁾. The ability of alternative fuels to be used as a drop-in fuel in legacy aircraft is very important along with their ability to meet future fuel standards. The present aviation fuel specifications are laid out in the American Society for Testing and Materials (ASTM) D 1655⁽¹⁰⁾. Any new fuel has to meet the specifications and has to go through a rigorous approval process as shown in Fig. 1⁽¹¹⁾. Any new alternate fuel development program must consider all other aspects of airframe, fuel handling and fuel processing as well⁽¹²⁾.

In recent years, several commercial aircrafts have performed flight demonstrations burning various blends of novel alternative fuels and conventional jet fuels. The ASTM has approved blends of up to 50% synthetic blend stocks to be used with conventional jet fuel⁽¹³⁾. Researchers have done various studies on the use of alternative fuels in gas turbines, both for military and commercial aviation^(14–26). It has also been observed in various studies that there is an advantage in using alternative blends for gas turbines as the use of paraffinic alternative fuels aids in reducing the net carbon footprint, particulate and smoke emissions^(27–32). This can also contribute to improving the local air quality^(14,15,19–25). Rye and Wilson⁽²⁷⁾ studied the effect of alternative fuel composition on gas turbine ignition performance. Lobo et al.⁽²⁸⁾ studied the effect of fuels derived from alternative sources on non-volatile particulate matter (PM) emissions. In recent years, studies have presented results on vibrational and noise production while using alternative fuels^(29,30,33).

There are various studies in the literature regarding the overall environmental impact, global warming potential and the use of alternative fuels in gas turbines^(26,28–31,34–47). Recent studies by Christie et al.⁽⁴⁷⁾ and Brem et al.⁽²⁶⁾ show the impact of hydrogen content in the fuel on PM emissions. Results of experimental tests related to the impact of gas turbine engines on the environment are not evident in the literature and not fully explored. One of the reasons for fewer studies and tests on the use of alternative fuels with gas turbines is the high cost and fuel requirement for a gas turbine engine for completing these tests. APUs, however, are well suited to perform studies and critical evaluations of alternative fuels for use in gas turbines.

This paper reports the results of an experimental campaign to evaluate the gaseous and PM emissions characteristics of an aircraft APU burning various blends of synthetic fuels with Jet A-1 and several other alternative fuels. The study was partially conducted by the FAA CLEEN project at the University of Sheffield's Low Carbon Combustion Centre and involved teams from the University of Sheffield, British Airways and Rolls-Royce. Gas phase emissions and PM emissions were measured at the engine exit plane.

2.0 PROPERTIES OF FUELS TESTED

Properties and a list of the fuels tested in this study are presented in Table 1. The blending was carried out using grade A glassware. The uncertainty in the volumetric blending was calculated to be approximately $\pm 1\%$. For ease of data representation, the fuels have been named fuels 1 to 6 and fuel A to H as shown in Table 1. Fuels 1 to 4 are different blends of SPK and Baseline Jet A-1, whereas fuels A to D are different ASTM-approved novel jet fuels to be blended with conventional jet fuel sourced from different companies. Fuel 5 is commercially available diesel, and fuels E-H are novel fuels from different sources not currently approved under ASTM.

2.1 Experimental set-up

A re-commissioned APU gas turbine (Honeywell GTCP85 APU engine) has been used in this study to examine the effect of different fuel blends on emissions and performance. Figure 2 shows a schematic of the experimental set-up used in this study. Real-time data acquisition system and control mechanisms have been used for conducting these experiments. Performance parameters including exhaust gas temperatures, bleed air flow, fuel flow, inlet air flow, engine RPM, pressure and temperature at various core locations have been measured and examined. This APU gas turbine has a two-stage centrifugal compressor. The compressed

Table 1
Pertinent properties of fuels used

Fuel	Representation Name	Density (g/l)	Energy Content (MJ/kg)	Fuel Aromatic Content (% vol)
Baseline Jet A-1	Fuel 1	801.9	43.23	17.3
50% Jet A-1 and 50% SPK	Fuel 2	781.9	43.66	8.6
25% Jet A-1 and 75% SPK	Fuel 3	771.8	43.88	4.4
SPK	Fuel 4	761.7	44.10	0.1
Diesel	Fuel 5	832.0	45.0	23.6
Straight Run Jet A	Fuel 6			
Novel Fuel 1	Fuel A	791.0	43.57	9.4
Novel Fuel 2	Fuel B	756.2	43.67	13.4
Novel Fuel 3	Fuel C	756.2	43.47	19.7
Novel Fuel 4	Fuel D	804.4	43.26	15.8
Novel Fuel 5	Fuel E			
Novel Fuel 6	Fuel F			
Novel Fuel 7	Fuel G			
Novel Fuel 8	Fuel H			

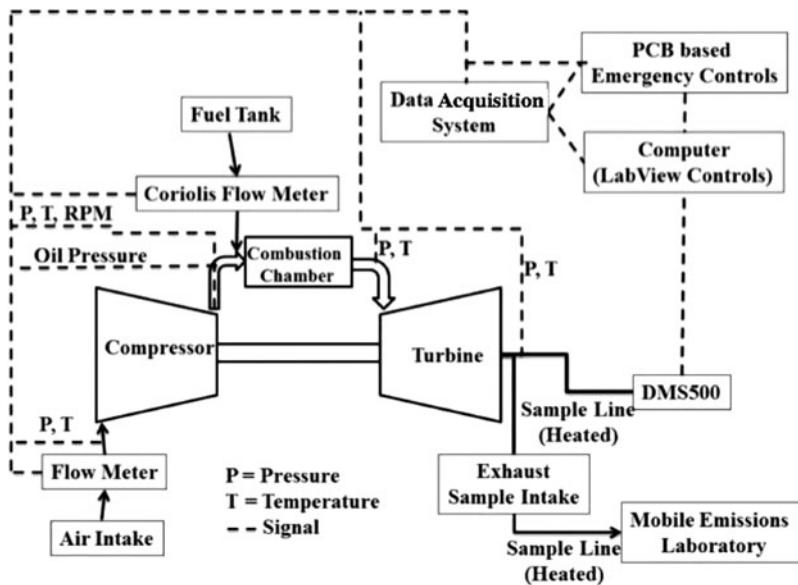

Figure 2. Experimental set-up.

air mixed with fuel and ignited drives a radial inward-flow turbine wheel. The rotating shaft power of the turbine wheel drives the compressor, which also provides bleed air, and generator.

The APU control panel is used to change the bleed flow rate to a predefined value for reaching a set operating condition. Figure 3 shows an actual picture of the APU, inlet

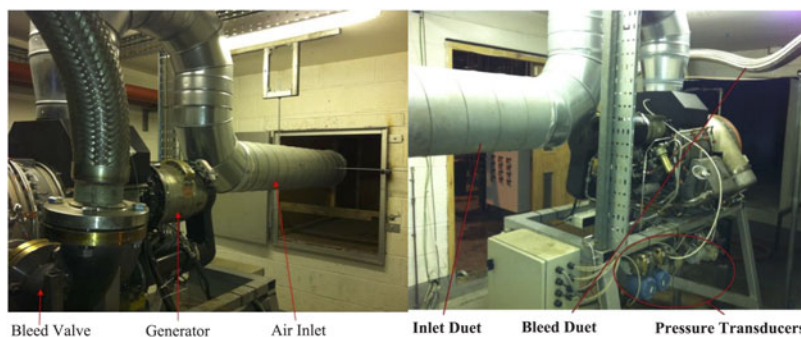

Figure 3. Gas turbine experimental set-up.

duct, generator, transducers and bleed valve mounted on the test bed. All the relevant performance parameters are measured with the help of pressure transducers, flow meters and thermocouples fixed on the engine bed and engine. The bleed duct is connected to a variable solenoid-operated valve before the exhaust to control the flow of bleed air, as bleed air is used for loading the APU (changing operating conditions). This APU also houses a 32 Kilowatt (KW) generator, which is conventionally used to control the operating conditions of the APU. The generator on the APU is not able to change the operating conditions of the engine, since power generated by the APU is substantially higher than that of the generator and no noticeable change in fuel flow and exhaust gas temperature is observed when the generator is fully loaded or when the load on the generator load is changed. Calibration of all the transducers used in the experimental set-up has been carried out regularly to maintain measurement accuracy. The operation panel (PCB-based control panel) is used to monitor exhaust gas temperature, engine operating speed (rpm) and bleed flow rate. This is installed to act as a safety control mechanism in case the more complex control software based on LabVIEW stops responding. The operation panel also provides control of fuel solenoid, starter motor and ignition system. The starter motor is used to spool the engine to 50% speed of engine RPM (maximum) before being cut off. The ignition system is cut off when the engine RPM reaches 95% speed of engine RPM. This is done to avoid any damage to the igniter. Boolean data on the status of the ignition, fuel and oil systems are also fed from the APU to the operation panel for the purpose of operator feedback and emergency shutdown.

Continuous sampling and measurement of gaseous emission have been carried out as per Society of Automotive Engineers (SAE) ARP1256D testing standards. The University of Sheffield's Mobile Emissions Laboratory has been set up to comply with the SAE ARP1256D standard⁽⁴¹⁾, and has been used to take measurements in this study. The same laboratory has also been used for measuring emissions in various other test campaigns available in literature^(19,27-31).

A stainless-steel sampling probe is fixed in place with bolts behind the APU for extractive sampling of exhaust gases. The probes themselves do not conform to the previously mentioned ARP standard. A cross-section traverse of the engine exhaust has been done, and it was found that two locations where these probes were placed had the same AFR and PM. The conditioned exhaust sample is drawn through a 1/4 inch heated sample line into the Mobile Emissions Laboratory for analysis. The sample lines are maintained at $160 \pm 5^\circ\text{C}$ per ARP1256D⁽⁴¹⁾ with a minimum bend radius of $10 \times$ the line diameter. A constant sampling flow rate (and system pressure) was maintained in the gaseous analysis equipment by using a metal bellows pump, with excess sample flow being exhausted through a back-pressure



Figure 4. Sampling probe.

regulator. Gaseous emissions (unburnt hydrocarbon ‘UHC’, Total Hydrocarbon (THC), carbon monoxide ‘CO’ and nitrous oxide ‘NO_x’) were measured per ARP1256D⁽⁴¹⁾. A flame ionization detector (FID), namely a Signal 3000HM hydrocarbon analyser, was used to measure unburned hydrocarbons in the exhaust stream. The concentration of CO and CO₂ emissions in the exhaust stream was characterized using a Rosemount Binos 1000 analyser. The unit is a dual channel Non-Dispersive Infrared Analyzer (NDIR), the principle of which is based on the absorption of infrared radiation in the CO and CO₂ frequency band. In order to reduce the interference effect of water in the exhaust sample, a chiller was installed upstream of the NDIR analyser to dry the sample. Figure 4 shows the location of sampling probes with reference to the exhaust of engine.

An Eco Physics chemiluminescence (CLA EL ht) analyser was used to record NO_x in this experiment. Oxygen levels in the exhaust sample were also monitored as a redundant measurement to assess data quality. The analysers were zeroed and then spanned using appropriate gas concentrations just prior to the beginning of each experiment, with the zero and span drift established at engine shutdown. The span gas cylinders were accurate to $\pm 2\%$. Instrument linearity and interference effects were assessed and corrected for as per the aerospace recommended practices⁽⁴²⁾. The experimental error associated with the measurement of gaseous emissions is estimated to be approximately $\pm 4\%$ of the reading.

A separate sampling probe was fixed in close proximity to the gaseous emissions sampling probe for measurement of particulates by DMS500. Smoke emissions were measured using the gaseous emissions probe. PM size distribution and mass were tested using a DMS 500 supplied by Cambustion. A separate sampling line heated at $160 \pm 5^\circ\text{C}$ was used to supply exhaust gases to the DMS 500. For uniformity with gaseous emission sample lines, the line was fabricated with a minimum bend radius of $10 \times$ the line diameter in the sampling line for both DMS 500 and gas sampling line to avoid any error in the readings taken. The DMS500 analysers use electrical mobility measurements to produce particle size/number spectra between 5 nanometres and 1,000 nanometres. Since the classification of particles according to their differing electrical mobility takes place in parallel (rather than in series as in a scanning instrument), the DMS series is able to offer the fastest available size/number spectral measurement of its type. The DMS500 uses a high sample flow rate (8 litres per minute) and unique multiple sheath flows in the charger, resulting in low diffusion losses even of small particles. Figure 5

Table 2
Details of measurement instruments

Species Measured	Analyser	Detection Range
Unburned Hydrocarbon	Signal 3000HM FID Hydrocarbon Analyzer	0–100 ppm
NO, NO ₂ , NO _x	EcoPhysics CLA 700 EL ht	0–100 ppm
CO	NDIR Rosemount Binos 1000	0–1,500 ppm
CO ₂	NDIR Rosemount Binos 1000	0–5%
O ₂	MAG	0–100%
SMOKE	Richard Oliver smoke meter (SAE Smoke number)	0–100
Particulate	Cambustion DMS500	5–1,000 nm

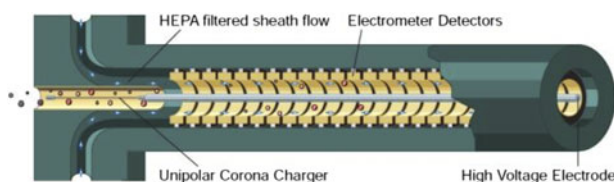

Figure 5. Principle of particulate emission measurement instrument (DMS 500)⁽⁴³⁾.

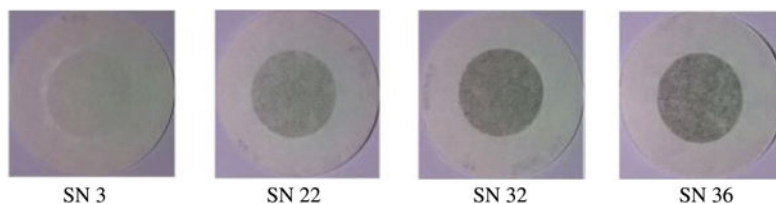

Figure 6. Actual pictures of Whatman no. 4 filter paper with varying SAE smoke number.

shows the schematic of the particulate measurement instrument principle. Particles are introduced in the instrument from the left hand side of the tube; particulates are provided a charge by a Unipolar Corona Charger and passed through tube of electrometer detectors to detect the size, weight and number of particulate emissions.

The SAE smoke number was established using a Richard Oliver smoke meter, Whatman no. 4 filter paper and a reflectometer (EEL43M Smokestain Reflectometer, Diffusion Systems Ltd.) per ARP1179c⁽⁴⁴⁾. The technique involves passing a set volume of sample through the conditioned filter paper and measuring the change in the absolute reflectance of the filter paper due to the PM collected. Figure 6 shows four different filter papers with varying SAE smoke numbers for representation purpose. Details of measurement instruments deployed in this study are shown in Table 2.

Three different test windows were selected to determine the performance of the APU for a range of conditions. Sampling at the selected test condition was conducted over a six-minute experimental window once the APU had appeared to stabilize. Figure 7 shows the exhaust temperature profile measured at the exit of the gas turbine with time. One test window is at full RPM when the engine is without any load at an EGT of $300 \pm 10^\circ\text{C}$ and AFR of 130 ± 2 , the second is with the bleed on at EGT of $445 \pm 10^\circ\text{C}$ and AFR of 75 ± 2 and the third with the

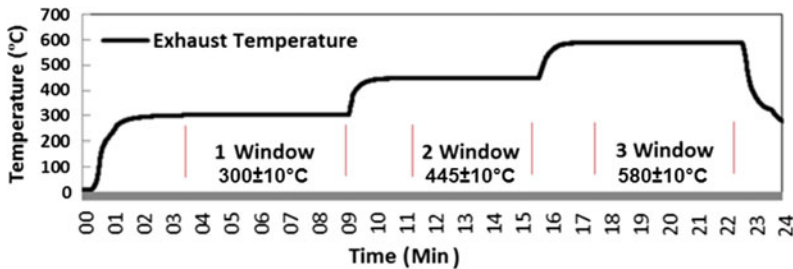

Figure 7. Exhaust temperature profile for illustration of engine test windows.

bleed on at EGT of $580\pm 10^{\circ}\text{C}$ and AFR of 50 ± 2 test windows before returning the engine to a full power condition prior to shut down. Full RPM window is stable when EGT remains constant at $300\pm 5^{\circ}\text{C}$ for three minutes. The second and third windows are stable when EGT remains constant at $445\pm 10^{\circ}\text{C}$ and $580\pm 10^{\circ}\text{C}$, respectively, in addition to the bleed mass flow for three minutes.

3.0 RESULTS AND DISCUSSION

Emissions data concentrations have been converted into emission indices to aid in the quantification of emissions per kilogram of fuel burned. The conversion to emission indices is done as per standard calculation methods^(19,42).

3.1 Gaseous emissions analysis

Table 3 shows gaseous emissions data collected at maximum RPM with EGT of $300\pm 10^{\circ}\text{C}$ and AFR of 130 ± 2 for different fuels. CO_2 , CO, NO_x and NO emissions are represented in the form of an emission index (EI), whereas NO_2 , THC is represented as PPM.

It is observed that all the fuels give similar range of emissions. Table 4 represents gaseous emissions data collected at EGT of $450\pm 10^{\circ}\text{C}$ and AFR of 75 ± 2 for different fuels.

Table 5 represents gaseous emissions data collected at EGT of $580\pm 10^{\circ}\text{C}$ and AFR of 50 ± 2 for different fuels. Gaseous emissions analysis (CO, CO_2 , NO, NO_x and THC) conducted on fuels studied in this work showed similar performance for all fuels and were within the uncertainty of instruments. It can be seen that for all fuels, NO_x remains relatively the same hovering around 4 ppm and also does not appear to change with the engine condition. Moreover, it can be seen that THC for Fuel 6 is extremely high with respect to the other fuels in the first two conditions. Even though total NO_x remains relatively constant with respect to engine condition, the amount of NO increases with engine condition. The amount of NO_2 also increases as engine condition increases. This phenomenon can be attributed to the higher engine peak flame temperatures reached as more power is extracted from the engine.

3.2 Smoke number

SAE smoke numbers for all the fuels tested in this study are presented in Fig. 8. The accepted accuracy of the method is ± 3 smoke numbers, and average of three different samples is presented in Fig. 8. It is observed that fuels 1 to 4 produce substantially lower smoke as compared to fuels with Jet A. Fuel 5 has the highest smoke number of all for all three conditions; this can be expected as fuel 5 is diesel and has the highest aromatic content as compared to the other fuels tested in this study. Diesel's higher smoke results are in line with other published

Table 3
Gaseous emissions data at condition 1

	Uncertainty	Fuel 1⁽⁴⁵⁾	Fuel 2⁽⁴⁵⁾	Fuel 3⁽⁴⁵⁾	Fuel 4⁽⁴⁵⁾	Fuel 5	Fuel 6	Fuel A⁽⁴⁵⁾	Fuel B⁽⁴⁵⁾	Fuel C⁽⁴⁵⁾	Fuel D⁽⁴⁵⁾	Fuel G	Fuel H
CO ₂ (EI)	± 10.0	3,171.0	3,178.0	3,182.0	3,182.0	3,165.0	3,175.0	3,188.0	3,192.0	3,189.0	3,189.0	3,201.0	3,185.0
CO (EI)	± 2.0	34.1	33.2	31.9	31.6	37.5	33.8	33.6	30.5	33.0	33.3	30.2	35.4
NO _x (EI)	± 0.1	4.0	4.1	4.2	4.2	3.9	4.0	4.0	4.0	3.9	4.0	4.2	4.1
NO (EI)	± 0.1	1.5	1.6	1.6	1.5	2.0	1.7	1.5	1.6	1.7	1.6	1.6	1.8
NO ₂ (PPM)	± 0.1	7.0	7.5	7.4	6.9	10.0	8.1	7.0	7.4	7.9	7.2	7.3	8.8
THC (PPM)	± 3.0	25.0	23.0	21.0	22.0	72.4	8.0	10.0	6.0	1.0	5.0	3.0	6.0
Oxygen (%)	± 0.2	18.4	18.4	18.4	18.5	18.3	18.4	18.4	18.4	18.4	18.4	18.5	18.4

Table 4
Gaseous emissions data at condition 2

	Uncertainty	Fuel 1⁽⁴⁵⁾	Fuel 2⁽⁴⁵⁾	Fuel 3⁽⁴⁵⁾	Fuel 4⁽⁴⁵⁾	Fuel 5	Fuel 6	Fuel A⁽⁴⁵⁾	Fuel B⁽⁴⁵⁾	Fuel C⁽⁴⁵⁾	Fuel D⁽⁴⁵⁾	Fuel G	Fuel H
CO ₂ (EI)	± 10	3,169.0	3,172.0	3,172.0	3,174.0	3,162.0	3,170.0	3,171.0	3,171.0	3,170.0	3,170.0	3,172.0	3,162.0
CO (EI)	± 2.0	23.9	22.9	21.3	22.1	26.3	22.8	23.2	21.5	23.5	23.7	21.4	24.3
NO _x (EI)	± 0.1	4.0	4.1	4.2	4.2	4.0	4.0	4.0	4.0	3.9	4.1	4.0	3.9
NO (EI)	± 0.1	2.0	2.1	2.2	2.1	2.5	2.2	2.1	2.2	2.1	2.1	2.1	2.2
NO ₂ (PPM)	± 0.1	16.4	16.8	18.1	16.2	21.0	18.8	16.5	17.7	17.2	16.7	16.6	17.0
THC (PPM)	± 3.0	1.0	0.0	0.0	0.0	3.0	48.0	3.0	2.0	0.0	1.0	25.0	55.0
Oxygen (%)	± 0.2	16.7	16.8	16.7	16.9	16.5	16.7	16.7	16.8	16.7	16.8	16.9	16.7

Table 5
Gaseous emissions data at condition 3

	Uncertainty	Fuel 1⁽⁴⁵⁾	Fuel 2⁽⁴⁵⁾	Fuel 3⁽⁴⁵⁾	Fuel 4⁽⁴⁵⁾	Fuel 5	Fuel 6	Fuel A⁽⁴⁵⁾	Fuel B⁽⁴⁵⁾	Fuel C⁽⁴⁵⁾	Fuel D⁽⁴⁵⁾	Fuel G	Fuel H
CO ₂ (EI)	± 10.0	3,169.0	3,171.0	3,172.0	3,172.0	3,164.0	3,171.0	3,170.0	3,171.0	3,170.0	3,171.0	3,173.0	3,169.0
CO (EI)	± 2.0	14.1	13.4	13.0	12.8	17.4	14.1	14.0	13.0	14.0	13.9	12.7	14.4
NO _x (EI)	± 0.1	4.1	4.2	4.2	4.2	4.1	4.1	4.4	4.1	4.0	4.2	4.1	4.0
NO (EI)	± 0.1	2.9	2.9	3.0	2.9	3.0	3.0	2.8	2.9	2.8	2.9	2.9	2.8
NO ₂ (PPM)	± 0.1	34.1	33.4	33.6	47.9	35.0	33.2	32.4	33.2	32.3	33.3	33.1	33.4
THC (PPM)	± 3.0	0.0	0.0	0.0	0.0	0.0	0.0	1.0	1.0	0.0	0.0	0.0	0.0
Oxygen (%)	± 0.2	14.9	15.1	15.1	15.2	14.9	15.2	15.1	15.2	15.0	15.1	15.2	15.0

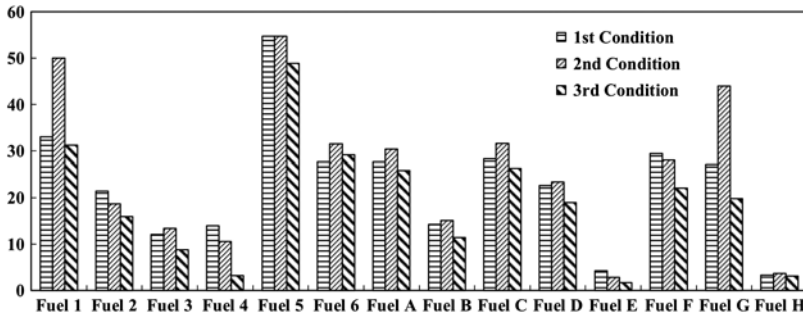

Figure 8. SAE smoke number distribution for all fuels and conditions. Fuels 1-4 and A-D⁽⁴⁵⁾.

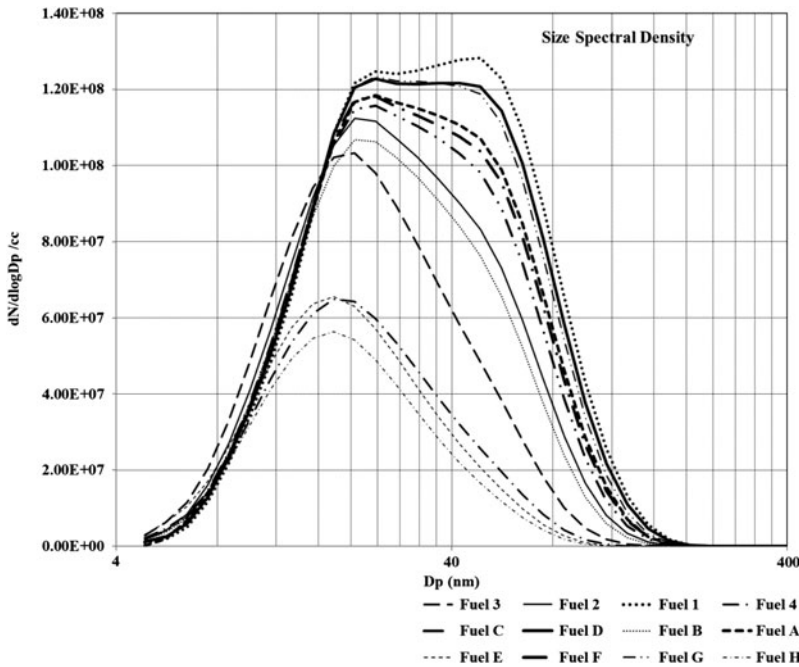

Figure 9. Number and size distribution of particulates measured for 1st condition.

literature. Fuels E and H have the lowest smoke number of all the fuels tested. Fuel A, B, C and D have significantly lower smoke as compared to Jet A-1. It can be observed from the figure that as the third-power condition smoke emissions go down, this could be due to thermophoretic losses.

3.3 PM emissions

Figure 9 shows size spectral density comparison for first, second and third conditions for all fuels considered in this study. It can be clearly observed from the figure that particulates emissions decrease with a decline in aromatic content from Fuel 1 to 4. This is consistent with the smoke measurements as shown in Fig. 9. Fuels A, B, C and D follow a trend similar to that of Baseline Jet-A1 fuel. Overall, similar trends are observed at engine operating conditions 2 and 3 as shown in Figs. 10 and 11. It is also observed that at condition 1, fuels with higher

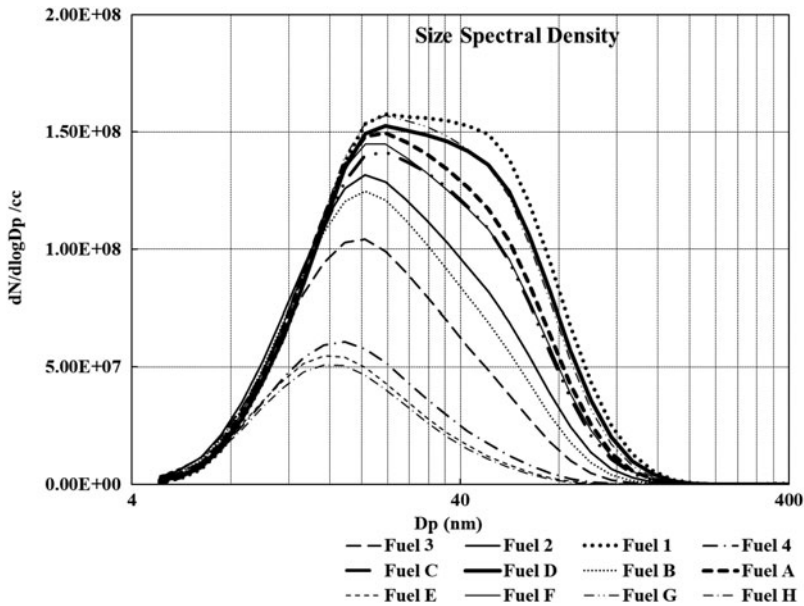

Figure 10. Number and size distribution of particulates measured for 2nd condition.

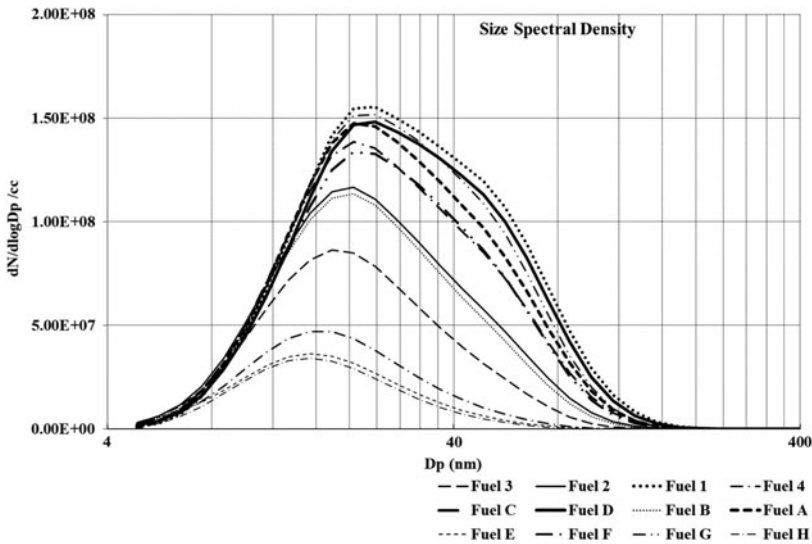

Figure 11. Number and size distribution of particulates measured for 3rd condition.

aromatic content produce substantially larger particulates as compared to fuels with a lower proportion of aromatics.

Figure 12 shows the distribution of particulate mass for all the fuels and conditions tested in this study. To calculate the mass of the particulates coming out of the test engine, effective density of baseline Jet A-1 fuel was used⁽⁴⁶⁾. It can be clearly observed that particulate mass follows the same trend as particulate numbers when aromatics are decreased from Fuel 1 to 4 (shown in Figs. 10–12). Fuel 1 and Fuel B have 24.6% and 21.7% aromatic content by weight,

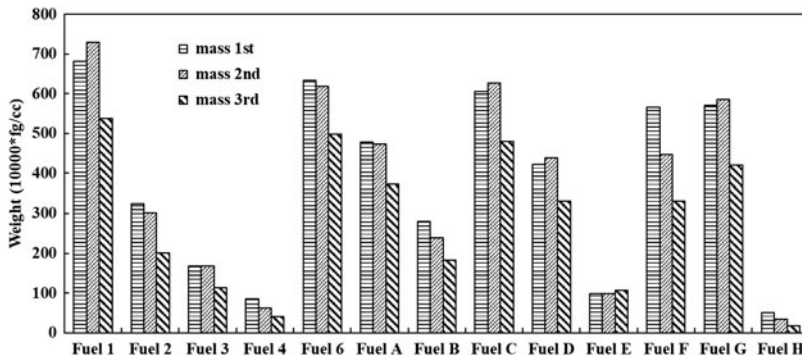

Figure 12. Particulates measured for fuels at size of ~ 27 nm.

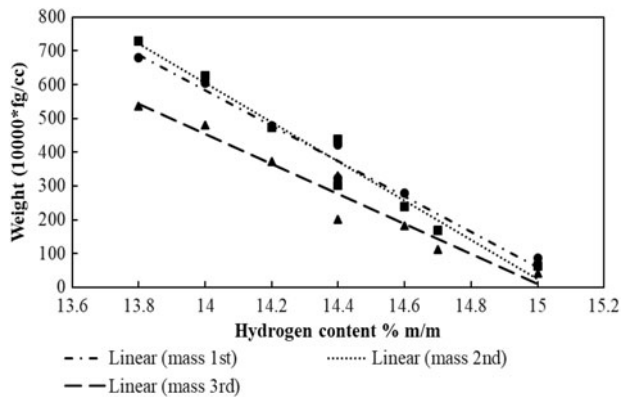

Figure 13. Particulate mass concentration against hydrogen contents of fuels.

respectively, whereas their mass and particulate size distribution differ substantially. Fuel B gave a substantially better performance in terms of particulate mass and size emissions. The probable reason for the reduction in particulate emissions in the case of Fuel B is due to its aromatic content composition. This result is in line with one of our other studies that found that different aromatic composition behaves in a different manner when it interacts with seals and produces different PM^(22,41). It is to be noted that seals could lead to production of a small number of volatiles in the exhaust and this aspect has not been covered in this study. Decreasing the number of aromatics in the fuel would lead to reduction in energy density per litre of the fuel, which could eventually lead to reduction in range of the aircraft. Not all aromatics have a direct effect on smoke and particulate emissions; it is just that the right aromatic species need to be selected for reduction in particulate emissions and appropriate seal swell.

Figure 13 above shows the particulate mass concentration against the hydrogen content (mass percentage % m/m). It can be observed from Fig. 13 that the particulate concentration is reduced as the hydrogen content is increased. This can be fundamentally explained by the fact that the more the hydrogen content is, the less the number of carbon-carbon bonds present in the fuel. This observation is in line with other literature such as Christie et al.⁽⁴⁷⁾ and Brem et al.⁽²⁶⁾.

Figure 14 shows the particulate mean gravimetric diameter against the hydrogen content (mass percentage % m/m). It can be observed from the figure that the gravimetric diameter of

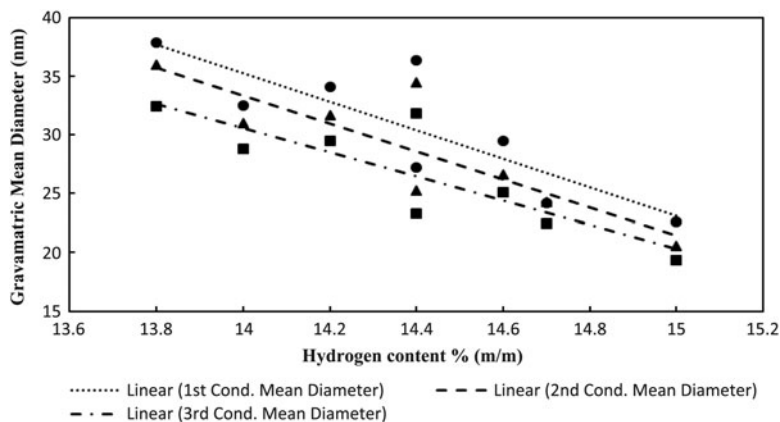

Figure 14. Particulate mean gravimetric diameter against hydrogen content of fuels tested.

particulates is reduced as the hydrogen content is increased. These findings are corroborated in studies by Christie et al.⁽⁴⁷⁾ and Brem et al.⁽²⁶⁾.

4.0 CONCLUSIONS

Gaseous emissions analysis (CO , CO_2 , NO , NO_x and THC) conducted on fuels studied in this paper showed similar performance and results were within the uncertainty of instruments. The smoke and particulate emissions of the SPK fuel were substantially lower than other fuels tested in this study. It is observed from the results that smoke and particulate emissions are decreased with a reduction in aromatic content of the fuel. It has also been observed that PM emissions also depend on the hydrogen content of the fuel. Particulate mass emissions of Fuel B are substantially lower than other comparative fuels, due to different types of aromatics, even though fuel B contains more aromatic content by volume than Fuel A. Further study is required to evaluate the effect of different types of aromatics on particulate emissions. Some investigation into the composition of aromatics and their specific impact on emissions has been studied by Corporan et al.⁽²²⁾.

ACKNOWLEDGEMENTS

The Honeywell GTCP85 APU used in this test campaign was kindly donated by British Airways. Part of this work was funded by the US Federal Aviation Administration (FAA) Office of Environment and Energy as a part of CLEEN Program under FAA Award Number: DTFWA-10-C-00006. Any opinions, findings, and conclusions or recommendations expressed in this material are those of the authors and do not necessarily reflect the views of the FAA or other CLEEN Sponsors.

REFERENCES

1. AIRBUS Global Market Forecast 2012–2031 – The Air Blog. . . , Air Blog. 2013. <http://theairblog.weebly.com/pilot-blog/airbus-global-market-forecast-2012-2031> (accessed 13 February, 2019).

2. ŽARNOVSKÝ, J., PETKOVÁ, V., DRLIČKA, R. and DOBRÁNSKY, J. Air quality improvement by reduction of gas turbines emissions, *Appl Mech Mater*, 2013, 308, pp 159–164. doi:10.4028/www.scientific.net/AMM.308.159.
3. SCHUMANN, U., SCHLAGER, H., ARNOLD, F., OVARLEZ, J., KELDER, H., HOV, Ø., HAYMAN, G., ISAKSEN, I.S.A., STAEHELIN, J. and WHITEFIELD, P.D. Pollution from aircraft emissions in the North Atlantic flight corridor: Overview on the POLINAT projects, *J Geophys Res Atmos*, 2000, 105, pp 3605–3631. doi:10.1029/1999JD900941.
4. ROGERS, H.L., LEE, D.S., RAPER, D.W., FOSTER, P.M.D.F., WILSON, C.W. and NEWTON, P.J. The impacts of aviation on the atmosphere, *Aeronaut J*, 2002, 106, pp 521–546. doi:10.1017/S0001924000018157.
5. BLAKEY, S., RYE, L. and WILSON, C.W. Aviation gas turbine alternative fuels: A review, *Proc Combust Inst*, 2011, 33, pp 2863–2885. doi:10.1016/j.proci.2010.09.011.
6. MURUGESAN, A., UMARANI, C., SUBRAMANIAN, R. and NEDUNCHEZHIAN, N. Bio-diesel as an alternative fuel for diesel engines—A review, *Renew Sustain Energy Rev*, 2009, 13, pp 653–662. doi:10.1016/J.RSER.2007.10.007.
7. HEMIGHAUS, G., BOVAL, T., BOSLEY, C., ORGAN, R., LIND, J., BROUETTE, R., THOMPSON, T., LYNCH, J. and JONES, J. Alternative jet fuels a supplement to Chevron's aviation fuels technical review, Chevron, 2006. <https://skybrary.aero/bookshelf/books/2479.pdf> (accessed 13 February, 2019).
8. YILDIRIM, U. and ABANTERIBA, S. Manufacture, qualification and approval of new aviation turbine fuels and additives, *Procedia Eng*, 2012, 49, pp 310–315. doi:10.1016/j.proeng.2012.10.142.
9. PARKER, R. and LATHOUD, M. Green aero-engines: Technology to mitigate aviation impact on environment, *Proc Inst Mech Eng Part C J Mech Eng Sci*, 2010, 224, pp 529–538. doi:10.1243/09544062jmes1515.
10. ASTM, ASTM D1655 18a standard specification for aviation turbine fuels, 2018.
11. ASTM, ASTM D4054 standard practice for evaluation of new aviation turbine fuels and fuel additives, 2017.
12. BLAZOWSKI, W.S. Combustion considerations for future jet fuels, *Symp Combust*, 1977, 16, pp 1631–1639. doi:10.1016/S0082-0784(77)80442-6.
13. ASTM, D7566–17a standard specification for aviation turbine fuel containing synthesized hydrocarbons 1, 2017. doi:10.1520/D7566-17A.
14. CORPORAN, E., DEWITT, M.J., BELOVICH, V., PAWLK, R., LYNCH, A.C., GORD, J.R. and MEYER, T.R. Emissions characteristics of a turbine engine and research combustor burning a Fischer-Tropsch jet fuel, *Energy Fuels*, 2007, 21, pp 2615–2626. doi:10.1021/ef070015j.
15. ANDERSON, B.E., BEYERSDORF, A.J., HUDGINS, C.H., PLANT, J.V., THORNHILL, K.L., WINSTEAD, E.L., ZIEMBA, L.D., WHITEFIELD, P.D., HAGEN, D., LOBO, P., HOWARD, R., KNIGHTON, W.B., BULZAN, D., TACINA, K., WEY, C., CORPORAN, E., VANDER WAL, R., MIAKE-LYE, R.C., HERNDON, S.C., BHARGAVA, A., DODDS, W., KINSEY, J., LEE, B., SANTORI, G. and LISCINSKY, D.S. Alternative Aviation Fuel Experiment (AAFEX), 2011. <http://www.sti.nasa.gov> (accessed 14 February, 2019).
16. MOORE, R.H., SHOOK, M., BEYERSDORF, A., CORR, C., HERNDON, S., KNIGHTON, W.B., MIAKE-LYE, R., THORNHILL, K.L., WINSTEAD, E.L., YU, Z., ZIEMBA, L.D. and ANDERSON, B.E. Influence of jet fuel composition on aircraft engine emissions: A synthesis of aerosol emissions data from the NASA APEX, AAFEX, and ACCESS missions, *Energy Fuels*, 2015, 29, pp 2591–2600. doi:10.1021/ef502618w.
17. MOORE, R.H., THORNHILL, K.L., WEINZIERL, B., SAUER, D., D'ASCOLI, E., KIM, J., LICHTENSTERN, M., SCHEIBE, M., BEATON, B., BEYERSDORF, J., BARRICK, J., BULZAN, D., CORR, C.A., CROSBIE, E., JURKAT, T., MARTIN, R., RIDDICK, D., SHOOK, M., SLOVER, G., VOIGT, C., WHITE, R., WINSTEAD, E., YASKY, R., ZIEMBA, L.D., BROWN, A., SCHLAGER, H. and ANDERSON, B.E. Biofuel blending reduces particle emissions from aircraft engines at cruise conditions, *Nature*, 2017, 543, pp 411–415. doi:10.1038/nature21420.
18. ZHENG, L., LING, C., UBOGU, E.A., CRONLY, J., AHMED, I., ZHANG, Y. and KHANDELWAL, B. Effects of alternative fuel properties on particulate matter produced in a gas turbine combustor, *Energy Fuels*, 2018, 32, pp 9883–9897. doi:10.1021/acs.energyfuels.8b01442.
19. LOBO, P., HAGEN, D.E. and WHITEFIELD, P.D. Comparison of PM emissions from a commercial jet engine burning conventional, biomass, and Fischer-Tropsch fuels, *Environ Sci Technol*, 2011, 45, pp 10744–10749. doi:10.1021/es201902e.
20. WILLIAMS, P.I., ALLAN, J.D., LOBO, P., COE, H., CHRISTIE, S., WILSON, C., HAGEN, D., WHITEFIELD, P., RAPER, D. and RYE, L. Impact of alternative fuels on emissions characteristics of a gas turbine

- engine – Part 2: Volatile and semivolatile particulate matter emissions, *Environ Sci Technol*, 2012, 46, pp 10812–10819. doi:10.1021/es301899s.
21. LOBO, P., RYE, L., WILLIAMS, P.I., CHRISTIE, S., URYGA-BUGAJSKA, I., WILSON, C.W., HAGEN, D.E., WHITEFIELD, P.D., BLAKEY, S., COE, H., RAPER, D. and POURKASHANIAN, M. Impact of alternative fuels on emissions characteristics of a gas turbine engine – Part 1: Gaseous and particulate matter emissions, *Environ Sci Technol*, 2012, 46, pp 10805–10811. doi:10.1021/es301898u.
 22. CORPORAN, E., EDWARDS, T., SHAFER, L., DEWITT, M.J., KLINGSHIRN, C., ZABARNICK, S., WEST, Z., STRIEBICH, R., GRAHAM, J. and KLEIN, J. Chemical, thermal stability, seal swell, and emissions studies of alternative jet fuels, *Energy Fuels*, 2011, 25, pp 955–966. doi:10.1021/ef101520v.
 23. CHRISTIE, S., RAPER, D., LEE, D.S., WILLIAMS, P.I., RYE, L., BLAKEY, S., WILSON, C.W., LOBO, P., HAGEN, D. and WHITEFIELD, P.D. Polycyclic aromatic hydrocarbon emissions from the combustion of alternative fuels in a gas turbine engine, *Environ Sci Technol*, 2012, 46, pp 6393–6400. doi:10.1021/es300301k.
 24. LOBO, P., HAGEN, D.E. and WHITEFIELD, P.D. Measurement and analysis of aircraft engine PM emissions downwind of an active runway at the Oakland International Airport, *Atmos Environ*, 2012, 61, pp 114–123. doi:10.1016/j.atmosenv.2012.07.028.
 25. LEE, B.H., SANTONI, G.W., WOOD, E.C., HERNDON, S.C., MIAKE-LYE, R.C., ZAHNISR, M.S., WOFSY, S.C. and MUNGER, J.W. Measurements of nitrous acid in commercial aircraft exhaust at the Alternative Aviation Fuel Experiment, *Environ Sci Technol*, 2011, 45, pp 7648–7654. doi:10.1021/es200921t.
 26. BREM, B.T., DURDINA, L., SIEGERIST, F., BEYERLE, P., BRUDERER, K., RINDLISBACHER, T., ROCCI-DENIS, S., ANDAC, M.G., ZELINA, J., PENANHOAT, O. and WANG, J. Effects of fuel aromatic content on non-volatile particulate emissions of an in-production aircraft gas turbine, *Environ Sci Technol*, 2015, 49, pp 13149–13157. doi:10.1021/acs.est.5b04167.
 27. RYE, L. and WILSON, C. The influence of alternative fuel composition on gas turbine ignition performance, *Fuel*, 2012, 96, pp 277–283. doi:10.1016/j.fuel.2011.12.047.
 28. LOBO, P., CHRISTIE, S., KHANDELWAL, B., BLAKEY, S.G. and RAPER, D.W. Evaluation of non-volatile particulate matter emission characteristics of an aircraft auxiliary power unit with varying alternative jet fuel blend ratios, *Energy & Fuels*, 2015, 29, pp 7705–7711. doi:10.1021/acs.energyfuels.5b01758.
 29. KHANDELWAL, B., ROY, S., LORD, C. and BLAKEY, S. Comparison of vibrations and emissions of conventional jet fuel with stressed 100% SPK and fully formulated synthetic jet fuel, *Aerospace*, 2014, 1, pp 52–66. doi:10.3390/aerospace1020052.
 30. KHANDELWAL, B., ROY, S. and LORD, C. Effect of novel alternative fuels and compositions on vibrations of a gas turbine engine, 50th AIAA/ASME/SAE/ASEE Joint Propulsion Conference, American Institute of Aeronautics and Astronautics, Reston, Virginia, 2014. doi:10.2514/6.2014-3410.
 31. RUSLAN, M., AHMED, I. and KHANDELWAL, B. Evaluating effects of fuel properties on smoke emissions, Volume 4A: Combustion, Fuels and Emissions – Proceedings, 2016. p. V04AT04A046. doi:10.1115/GT2016-56791.
 32. KHANDELWAL, B., WIJESINGHE, C.J. and SRIRAMAN, S. Effect of alternative fuels on emissions and engine compatibility, 540492782in Runchal, A.K., Gupta, A.K., Kushari, A., De, A. and Aggarwal, S.K. (Eds.), *Energy for propulsion – A sustainable technologies approach*, Springer Singapore, Singapore, 2018. pp 27–50. doi:10.1007/978-981-10-7473-8_2.
 33. WIJESINGHE, C.J. and KHANDELWAL, B. Impact of alternative fuel on gas turbine noise, vibration and instability, AIAA Scitech 2019 Forum, American Institute of Aeronautics and Astronautics, 2019. doi:10.2514/6.2019-0240.
 34. BLAKEY, S., WILSON, C.W., FARMERY, M. and MIDGLEY, R. Fuel effects on range versus payload for modern jet aircraft, *Aeronaut J*, 2011, 115, 627–634. doi:10.1017/S000192400000631X.
 35. ROY, S. and KHANDELWAL, B. Comparison of gaseous emissions between jet A-1 and severely hydro-processed jet fuel from conventional sources, 13th International Energy Conversion Engineering Conference, American Institute of Aeronautics and Astronautics, Reston, Virginia, 2015. doi:10.2514/6.2015-4014.
 36. URYGA-BUGAJSKA, I., POURKASHANIAN, M., BORMAN, D., CATALANOTTI, E. and WILSON, C.W. Theoretical investigation of the performance of alternative aviation fuels in an aero-engine combustion chamber, *Proc Inst Mech Eng Part G J Aerosp Eng*, 2011, 225, 874–885. doi:10.1177/0954410011402277.

37. HAGEN, D.E., WHITEFIELD, P.D. and SCHLAGER, H. Particulate emissions in the exhaust plume from commercial jet aircraft under cruise conditions, *J Geophys Res*, 1996, 101, 19551. doi:10.1029/95JD03276.
38. WEY, C.C., ANDERSON, B.A., WEY, C., MIAKE-LYE, R.C., WHITEFIELD, P. and HOWARD, R. Overview on the Aircraft Particle Emissions Experiment (APEX), *J Propuls Power*, 2007, 23, 898–905. doi:10.2514/1.26406.
39. KHANDELWAL, B., UBOGU, E., AKRAM, M., BLAKEY, S. and WILSON, C.W. Experimental analysis on emission production and performance of stressed 100% SPK, stressed fully formulated synthetic jet fuel, Jet A-1 in a small gas turbine engine, 11th International Energy Conversion Engineering Conference, American Institute of Aeronautics and Astronautics, Reston, Virginia, 2013. doi:10.2514/6.2013-3936.
40. SHANKAR, V.S.B. and KHANDELWAL, B. Comparison of jet fuel produced by nonconventional sources: Manufacturing, emission and performance, 11th International Energy Conversion Engineering Conference, American Institute of Aeronautics and Astronautics, Reston, Virginia, 2013. doi:10.2514/6.2013-3937.
41. SAE, ARP1256 procedure for the continuous sampling and measurement of gaseous emissions from aircraft turbine engines, 1971. doi:10.4271/ARP1256.
42. SAE, ARP1533A procedure for the analysis and evaluation of gaseous emissions from aircraft engines, 2004. doi: 10.4271/ARP1533A.
43. Cambustion, DMS instrument principle cambustion, n.d. <https://www.cambustion.com/products/dms> (accessed 15 February, 2019).
44. SAE, ARP1179C aircraft gas turbine engine exhaust smoke measurement, 1997. doi:10.4271/ARP1179C.
45. Rolls-Royce, FAA, Rolls-Royce Alternative Fuels Program-Final Report (CLEEN), 2015.
46. JOHNSON, T.J., OLFERT, J.S., SYMONDS, J.P.R., JOHNSON, M., RINDLISBACHER, T., SWANSON, J.J., BOIES, A.M., THOMSON, K., SMALLWOOD, G., WALTERS, D., SEVCENCO, Y., CRAYFORD, A., DASTANPOUR, R., ROGAK, S.N., DURDINA, L., BAHK, Y.K., BREM, B. and WANG, J. Effective density and mass-mobility exponent of aircraft turbine particulate matter, *J Propuls Power*, 2015, 31, pp 573–582. doi:10.2514/1.B35367.
47. CHRISTIE, S., LOBO, P., LEE, D. and RAPER, D. Gas turbine engine nonvolatile particulate matter mass emissions: Correlation with smoke number for conventional and alternative fuel blends, *Environ Sci Technol*, 2017, 51, pp 988–996. doi:10.1021/acs.est.6b03766.