



UNIVERSITY OF LEEDS

This is a repository copy of *The Effect of Ambient Temperature on Cold Start Urban Traffic Emissions for a Real World SI Car* .

White Rose Research Online URL for this paper:
<http://eprints.whiterose.ac.uk/2526/>

Conference or Workshop Item:

Andrews, G.E., Zhu, G., Li, H. et al. (4 more authors) (2004) The Effect of Ambient Temperature on Cold Start Urban Traffic Emissions for a Real World SI Car. In: SAE 2004 Powertrain & Fluid Systems, October 2004, Tampa, Florida, USA.

Reuse

See Attached

Takedown

If you consider content in White Rose Research Online to be in breach of UK law, please notify us by emailing eprints@whiterose.ac.uk including the URL of the record and the reason for the withdrawal request.



eprints@whiterose.ac.uk
<https://eprints.whiterose.ac.uk/>



White Rose
university consortium
Universities of Leeds, Sheffield & York

White Rose Research Online

<http://eprints.whiterose.ac.uk/>

ITS

[Institute of Transport Studies](#)

University of Leeds

The following paper is published on this website with permission from SAE International. As a user of this website, you are permitted to view this paper on-line, download the pdf file and print one copy of this SAE paper at no cost for your use only. The downloaded pdf file and printout of this SAE paper may not be copied, distributed or forwarded to others or for the use of others. SAE Paper # 2004-01-2903 © 2004 SAE International.

White Rose Repository URL for this paper:

<http://eprints.whiterose.ac.uk/2526/>

Published paper

Andrews, G.E., Zhu, G., Li, H., Simpson, A., Wylie, J.A., Bell, M. and Tate, J.
(2004) *The Effect of Ambient Temperature on Cold Start Urban Traffic Emissions for a Real World SI Car* - Proceedings of SAE 2004 Powertrain & Fluid Systems Conference and Exhibition, October 2004, Tampa, FL, USA

The Effect of Ambient Temperature on Cold Start Urban Traffic Emissions for a Real World SI Car

Gordon E. Andrews, Grant Zhu, Hu Li, Alex Simpson and James A. Wylie

Energy and Resources Research Institute
School of Process, Environment and Materials Engineering
The University of Leeds, UK

Margaret Bell and James Tate

Institute of Transport Studies
The University of Leeds, UK

Reprinted From: **Emissions Measurement and Testing, Advanced Catalysts
and Substrates, and Diesel Gaseous Emissions
(SP-1899)**

SAE *International*[™]

**Powertrain & Fluid Systems
Conference and Exhibition
Tampa, Florida USA
October 25-28, 2004**

All rights reserved. No part of this publication may be reproduced, stored in a retrieval system, or transmitted, in any form or by any means, electronic, mechanical, photocopying, recording, or otherwise, without the prior written permission of SAE.

For permission and licensing requests contact:

SAE Permissions
400 Commonwealth Drive
Warrendale, PA 15096-0001-USA
Email: permissions@sae.org
Fax: 724-772-4891
Tel: 724-772-4028



For multiple print copies contact:

SAE Customer Service
Tel: 877-606-7323 (inside USA and Canada)
Tel: 724-776-4970 (outside USA)
Fax: 724-776-1615
Email: CustomerService@sae.org

ISBN 0-7680-1521-9
Copyright © 2004 SAE International

Positions and opinions advanced in this paper are those of the author(s) and not necessarily those of SAE. The author is solely responsible for the content of the paper. A process is available by which discussions will be printed with the paper if it is published in SAE Transactions.

Persons wishing to submit papers to be considered for presentation or publication by SAE should send the manuscript or a 300 word abstract of a proposed manuscript to: Secretary, Engineering Meetings Board, SAE.

Printed in USA

The Effect of Ambient Temperature on Cold Start Urban Traffic Emissions for a Real World SI Car

Gordon E. Andrews, Grant Zhu, Hu Li, Alex Simpson and James A. Wylie

Energy and Resources Research Institute
School of Process, Environment and Materials Engineering
The University of Leeds, UK

Margaret Bell and James Tate

Institute of Transport Studies
The University of Leeds, UK

Copyright © 2004 SAE International

ABSTRACT

The influence of ambient temperature on exhaust emissions for an instrumented Euro 1 SI car was determined. A real world test cycle was used, based on an urban drive cycle that was similar to the ECE urban drive cycle. It was based on four laps of a street circuit and an emissions sample bag was taken for each lap. The bag for the first lap was for the cold start emissions. An in-vehicle direct exhaust dual bag sampling technique was used to simultaneously collect exhaust samples upstream and downstream of the three-way catalyst (TWC). The cold start tests were conducted over a year, with ambient temperatures ranging from -2°C to 32°C . The exhaust system was instrumented with thermocouples so that the catalyst light off temperature could be determined. The results showed that CO emissions for the cold start were reduced by a factor of 8 downstream of catalyst when ambient temperature rose from -2°C to 32°C , the corresponding hydrocarbon emissions were reduced by a factor of 4. There was no clear relationship between NO_x emissions and ambient temperature. For subsequent laps of the test circuit the reduction of CO and HC emissions as a function of ambient temperature was lower. The time for catalyst light off increased by 50% as the ambient temperature was reduced. The results show that the vehicle used is unlikely to meet the new -7°C cold start CO emission regulations.

INTRODUCTION

In Europe, the USA and Japan passenger car emission regulations are for a cold start. However, this is defined at a summer's day temperature of 25°C and much lower temperatures are experienced in winter in many areas of the world. The impact on air quality of these lower cold start temperatures has led to the introduction of a -7°C cold start emissions test in Europe and the USA. In Europe all cities have to meet defined European air quality standards and must declare air quality management areas (AQMA) if they exceed these air quality standards. In an AQMA the city has to take action to determine the cause of the exceedence and has the power to introduce measures to reduce the emissions. In the UK nearly all cases where an AQMA has been declared has involved traffic pollution as the cause of the exceedence.

This project is part of a major study of real world emissions and the traffic control and road system impacts on real world vehicle emissions. In the present work the important influence of ambient temperature on urban passenger SI car emissions is investigated, as current data for legislated emission tests is all at 25°C , which is rarely seen in the UK. The present work uses a low traffic density city street drive cycle that is similar to the ECE Urban drive cycle and is used to show that the in vehicle emissions sampling system that was used

gives similar results to the ECE tests for a Euro 1 vehicle.

A Euro 1 vehicle was used as they are still a significant proportion of the UK vehicle fleet and hence major contributors to air pollution in cities. Future work will investigate Euro 2, 3 and 4 vehicles. It takes about 16 years for 90% of vehicles sold in any one year to be no longer in use (1) and this period are becoming longer for modern vehicles. Thus the work on Euro 1 vehicles has significance in terms of their current use in city driving and hence their impact on air quality. It will be at least 2013 before 90% of Euro 1 vehicles are not a significant proportion of city traffic. This work on Euro 1 vehicles will also be the basis for future work on the influence of ambient temperature and vehicles that meet subsequent lower emissions standards.

It is well known that a SI engine in cold conditions has much higher exhaust emissions than one that is fully warmed up (2-8). The new European passenger car emissions regulations has removed the first 40 seconds of idle period for the ECE driving cycle, in recognition of the importance of the cold start emissions. The new regulations also include -7°C tests for HC and CO emissions at cold start. It has to be addressed that Euro 1 cars were not developed to pass this cold test since developed prior to new -7°C regulation, and yet Euro 1 cars do cold starts at low temperatures in the real world. Extensive research had been undertaken in the past to investigate the influence of ambient temperature on exhaust emissions (2-8), normally using legislated test cycles and CVS test procedures. It was found that exhaust emissions could be drastically increased, relative to 25°C , at cold ambient conditions. For instance, the hydrocarbon emissions were found increase by 650% at -20°C and carbon monoxide emissions by 800% (8).

A cold start is very difficult to achieve at sub-zero ambient temperature conditions, especially when the vehicle is cold soaked overnight, as was done in the present work. The -7°C ECE test regulations do not allow the use of block heaters that are common in very cold climates (9). These are very effective and show that it is not the air temperature that is the main problem. The cold soak makes the oil, water, all metal surfaces and catalysts cold and it is the thermal energy required to heat these that is the main problem in cold starts (9-14).

A low ambient temperature reduces lubricating oil pumpability and increases the viscosity of lubricating oil (15-20). This results in higher mechanical losses and hence higher fuel consumption for an engine under cold start (15-21). The fuel vaporization at the inlet port injection location is deteriorated due to the poor volatility of fuel at low ambient temperatures. The lower the ambient temperature, the richer the air fuel mixture that

is required for a start up. The rich air fuel mixture results in incomplete combustion with excess fuel and thus increases carbon monoxide and hydrocarbon emissions, together with a further increase in the fuel consumption. The low ambient temperature also delays the light off of the catalyst, which is one of the most important reasons for high emissions at cold start.

The most convenient way to investigate the impact of the cold start and ambient temperature on exhaust emissions is to use an engine dynamometer test under specialized cold enclosure facilities. However, there are some limits for this sort of test, as they cannot represent the whole vehicle response to cold start, including gearbox and cold tyre effects. Although the legislated CVS test procedure can be included in a cold chamber, the cost of these is high and they are generally fully utilized for legislated test cycle work. Therefore, attention has been directed in this work on real world on road test in winter to complement dynamometer and CVS cold start tests (15). This work uses the variation of ambient temperature through the year to enable real world emissions for the same urban drive cycle to be determined as a function of ambient temperature.

This work is the initial phase of a major research project RETEMM (Real-world Traffic Measurement and Modeling), which is part of the LANTERN research programme (Leeds health Air quality, Noise, Traffic, Emissions Research Network). One of the purposes of the RETEMM project is to investigate the emissions characteristics under real world driving conditions, including the influence of ambient temperatures, driving cycles, traffic conditions, vehicle technologies etc. Vehicles with different emission compliances will be investigated such as pre-EURO1, EURO1, EURO 2, EURO 3 and EURO 4.

EXPERIMENTAL

TEST VEHICLE – A Ford Orion petrol car was used, fitted with a port fuel injected 1.8 litre Zetec spark ignition engine with DOHC 4 cylinders 16 valves. The car was instrumented with 27 thermocouples which measured the air inlet, engine cooling and lubricating oil temperatures. In addition the exhaust metal, gas and catalysts temperatures as well as the ambient temperature were also measured. All temperature measurements used grounded junction mineral insulated Type K thermocouples.

Table 1 identifies the thermocouples by number location and function. These numbers are used in the graphical presentation of the warm-up temperature results in real-world driving. Fig.1 shows the schematic view of the thermocouple locations on the test car and Fig.2 shows the outline of the data logging system that was used.

The total scan number was 480 during the 16 minutes of each test period, which was equivalent to one scan every two seconds. A Brantz International 2S Speed and Trip meter was used to measure vehicle's travel speed and distance, which was connected to a Daqbook/200 data logger along with all 28 thermocouples. The data logger was then connected to a Toshiba notebook PC.

Table 1 Thermocouple locations and functions

The number of thermocouple	The measuring target
1,2,3,4	Engine out gas temperatures from each cylinder.
5M,6M,7M,8M	Metal temperatures at four different locations on the manifold to monitor overall thermal profile on manifold
9, 10	Coolant water in and out from the engine
11W,12W,13W	Upstream TWC face temp. on left, right and centre positions.
14G,15G,16G	Gas temperature at the upstream (14), between the two catalyst bricks (15) and downstream of the TWC (16).
17W,18W,19W	Downstream TWC face temp. on left, right and centre positions
20,21	Engine oil in sump bottom (20) and dipstick top layer (21)
22M,23M,24M	Metal temperatures along the down-pipe
25G,26G,27G	Gas temperatures along the down-pipe
28 (not shown in graph)	Ambient temperature

Fig.2 On-board thermal data logging for Orion car

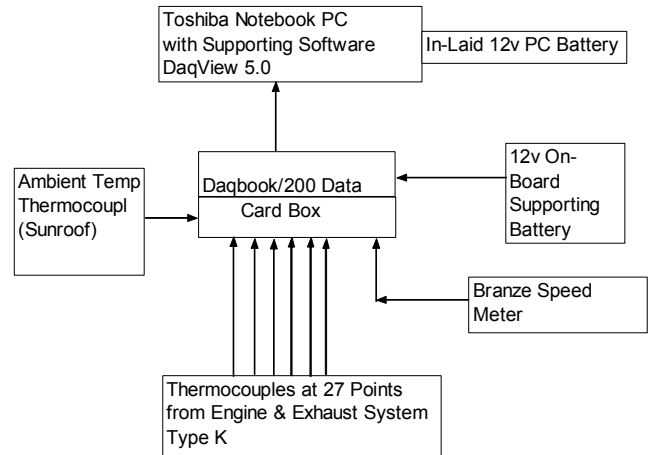

EXHAUST SAMPLING SYSTEM – Direct exhaust pipe samples were taken through unheated stainless steel tubes inserted just upstream and downstream of the TWC. The data by this direct exhaust sampling technique does not need correcting for background as there is no exhaust dilution. The layout of the gas sampling system is shown in Fig.3.

Fig.3 Schematic view of exhaust sampling system

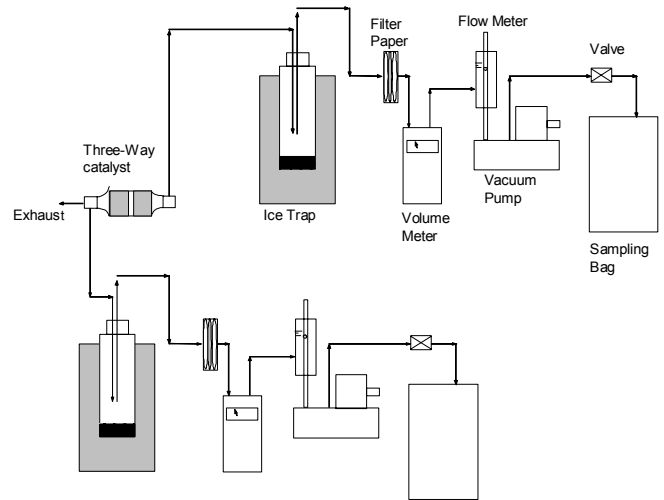
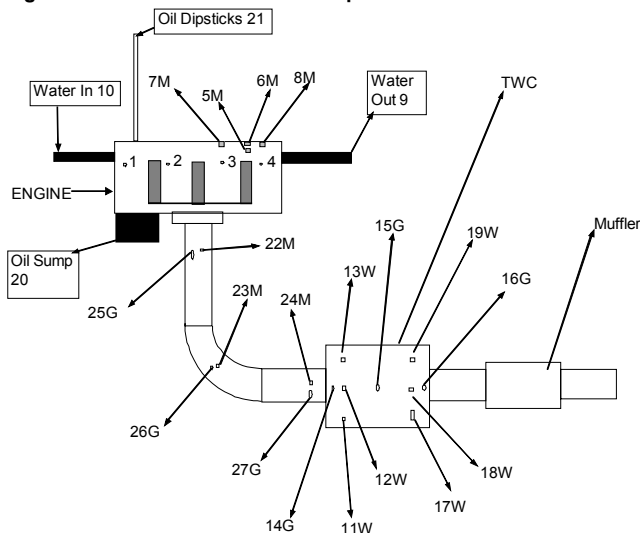

Fig.1 Schematic view of thermocouple locations



Exhaust gas samples were taken simultaneously from both gas sample points and the samples were fed through the floor of the vehicle and through an ice traps for water and unburned liquid fuel condensation. The condensate could be used to separate the 'liquid' unburned hydrocarbons from the gaseous unburned hydrocarbons that passed through to the bag sample. The sum of the two hydrocarbon measurements added together gives the total hydrocarbons. The analysis of this condensate is not reported here, but its detailed GC and GC-MS analysis will be reported separately. This condensate allows a 200+ speciation of the VOCs that are condensable at the ice bath temperature. This work showed that the gaseous bag sample contained typically 70% by mass of the total unburned hydrocarbons. GC

analysis of the bags was used to show that typically 10% of the bag hydrocarbons were methane.

After the ice bath water and hydrocarbon trap a particulate filter paper was mounted. This was used to provide a clean sample into the sample bags and also for particulate mass measurement and subsequent particulate analysis. The particulate analysis results using this system will be reported separately. Ahmad and Andrews (1998) have already used a similar system for SI particulate analysis on a Zetec engine on a dynamometer test bed.

After the particulate filter the dry clean exhaust sample was passed through a dry gas meter and then through a diaphragm pump to a 60 litre Tedlar (inert surface and light free) sample bag, where a gaseous sample for the whole sample period was collected. The sample diaphragm pump was not sensitive to exhaust gas pulsations so as to eliminate possible effect of exhaust pulsation during fuel cut off periods. The dry gas meter was required to quantify the filter paper mass in units of g/m^3 . Each bag was flushed out with nitrogen for about an hour. Test analysis showed that this procedure resulted in no residual gases that could be detected on the standard bag gas analysis equipment. The removal of water and condensable hydrocarbons in the ice bath condenser ensured that the high molecular weight hydrocarbons that often are difficult to remove from sample bags, did not reach the bags.

For each lap of the street test journey, a separate sample bag was collected upstream and downstream of the catalyst. For each cold start four laps of the street circuit was completed, changing the sample bags between each lap. For each cold start tests in the present work there were eight 60 litre gas sample bags that were immediately taken to the gas analysis system for conventional exhaust gas analysis.

It was a requirement of the present work that the impact of ambient temperature on the cold start phase of the emissions was resolved and this required that the emissions for the first kilometer of the cold start journey were determined in a separate bag. The gas analysis system required a sample flow rate of 20 litres per minute and it took a minute for all the analyzers to stabilize. The bag gases were then taken as the average of the gas analyzer outputs over the next minute. This resulted in a minimum requirement for a reliable bag gas analysis of 40 litres. It would be preferable if the bag sample could be collected by exhaust flow driven by the back pressure from the exhaust, as this would be proportionate exhaust gas sampling. Andrews et al (17,18) have shown that reliable results can be obtained for longer bus and truck journeys using the exhaust back pressure sampling method with no pump in the sample circuit. However, this was for journey times of typically

30 minutes and the desired sample period in the present work was about three minutes for each bag.

The use of the constant flow gas sample pump in the present work was to ensure that sufficient gas sample were collected in a short time, which was not possible using the back pressure gas sample technique. The bag constant sample flow rate was 9-10 l/min and the exhaust mass flow rate was varying throughout the test period. The bag sample was thus biased, with more samples from the low exhaust mass flow parts of the test cycle (low power) and less sample from the high exhaust mass flow parts of the test cycle. However, in city driving in speed limited street areas, only a small part of the engine power range was used and hence this sample bias was not as large as for journeys that would use a greater proportion of the engine power range. The net effect of the non-proportionate sampling was to increase the CO and HC emissions and decrease the NO_x emissions as these are generated more at low and high powers respectively. However, the results show that the HC, CO and NO_x emissions are as expected for a Euro 1 vehicle at 25°C cold start conditions. This indicates that the sample bias in this work did not have a major impact on the measurement of the ambient temperature effect under real world urban cold start driving.

At the time that this work was undertaken there were no commercially available reliable in-vehicle emissions analysis systems available. Such systems have recently been developed and two of these (FTIR and On Board analysis System) are currently in use for second by second analysis in this research group. Also in-vehicle emissions analysis systems have to be combined with an in-vehicle exhaust mass flow measurement system and these have only recently become available (21).

GAS ANALYSIS SYSTEM – The exhaust gas sample from the sample bags was analyzed using a conventional heated engine exhaust emissions analysis system using heated pumps and a heated FID at 180°C for total hydrocarbon analysis. A Chemiluminescence analyzer was used for NO and NO₂ analysis, a Servomex Paramagnetic analyzer for Oxygen analysis and a Hartman & Braun Uras 10E for CO, CO₂, CH₄ and N₂O analysis. As the bag sample was after a water and UC ice trap, all the samples were on a dry gas basis. All the concentrations were converted to a wet gas basis before conversion into mass emissions. The sample bag mean air/fuel ratio was also determined from the bag exhaust gas analysis by the carbon balance method. As this is a direct sampling technique and no exhaust dilution, data does not need correcting for background (Regulators do not allow any pollution entering the engine from ambient air to be deducted from the exhaust emissions).

MASS EMISSIONS – The sample bag emissions analysis was on a volumetric basis and this was converted into a mass basis using the conventional method for the computation of emission index (EI -g/kg fuel).

$$EI = K \times C \times (1 + A/F) \times 1000 \text{ g/kg fuel}$$

Where K is conversion coefficient, which is the ratio of molecular weight for a certain emission component to the whole emission sample gases

C is the concentration of a certain component of the emissions on a volume basis

A/F is the bag mean air/fuel ratio determined by carbon balance method based on wet gas analysis composition.

The gas concentrations were converted from a dry to wet basis prior to the calculation of the EI. The exhaust flow is not measured as not required by the calculation of the EI. If the concentration C was measured in ppm or % then the above equation has to be multiplied by 10^{-6} or 10^{-2} respectively. The MW of the sample gases is close to that of air and does not vary by more than 1% for gasoline as the fuel, irrespective of the A/F. Thus for each emission component, K is a constant and is 0.555 for methane (HC measured as methane equivalent), 0.971 for CO, 1.595 for NO₂ (all NO_x counted as NO₂), 1.526 for N₂O and 1.526 for CO₂.

The EI could be converted into emission units of g/km if the fuel consumption during the sample period was known. The accurate fuel consumption was not determined in this work for each bag sample, but the total fuel consumption over the four laps of the test circuit was determined by adding fuel to the tank to return it to the level at the start of the tests. All the test results are therefore presented in terms of an EI, as this was the measured mass emissions parameter. Comparison with the ECE emissions legislation levels will be made by converting these into an EI, using the published fuel consumption figures for the ECE test cycle for the Ford Orion. The results below show good agreement between the measured overall fuel consumption for the four laps of the test journey and those for the ECE test.

TEST ROUTE AND CYCLE – An urban driving cycle was designed and coded as LU-UDTC – The Leeds University Urban Driving Test Cycle. Fig.4 shows the route of the test cycle. Leeds metropolitan district has a high population density of around 1,300/km² and there is a network of roads with many 90° turns and the test street circuit in Fig.4 is typical of congested urban street layouts. The car was started from the authors' engine dynamometer laboratory, which is close to a public road. The car was parked outside the laboratory and cold soaked in the open overnight.

The cold start bag sample was started at the same time as the car by switching the sample pump on immediately after successful ignition of the engine had been achieved; the cranking phase of the cold start was not sampled. This is as close as possible to the new Euro 3 test procedures as could be achieved in real world cold start driving. The vehicle was first driven about 70m to the public road, where it was then driven around the street test circuit shown in Fig.4. This had a down hill and uphill portion in the top left part of the circuit in Fig.4, the rest of the circuit was flat. There were 7 90° turns in the circuit, 5 of them left hand turns.

At the end of each lap of the 1.45 km test circuit the vehicle was stopped in a car park and the sample bags were changed. Then the circuit was repeated. The first cold-start circuit was thus slightly different to the other three circuits. The main road to the right of Fig.4 was a very busy major road with one the highest traffic densities for an urban road in the UK. However, the traffic densities on the test circuit were much lower and the repeatability of each lap was not greatly influenced by differences in traffic loads.

The urban street test cycle was aimed at the simulation of the ECE15 urban driving cycle. Fig.5 shows the typical profile of the test cycle driving mode in comparison with the ECE15 mode. This shows that the urban test circuit was very close to the ECE urban test cycle in terms of the duration of each lap and the peak speed. Each of the four laps of the urban street test circuit was regarded as one phase of the test, similar to the four phases of the ECE test cycle. The first phase was under cold start conditions, as in the CE urban test cycle.

The distance traveled for each lap was 1.45 km, giving a total distance for the four laps of 5.8 km. It involved 18~21 gear changes for each lap, depending on the traffic conditions. The speed limit on these urban streets was 48 km/hr (30 mph) and the peak speed never exceeded this, as shown in Fig.5. Each section of the route involved acceleration from a 90° corner turn up to a peak speed close to the speed limit and then a deceleration to the next corner. Six or seven deceleration and acceleration modes were involved in each lap of the route. There were also short periods of idling between the laps due to traffic and changing the sampling bags.

Fig.4 Driving route of LU-UDTC

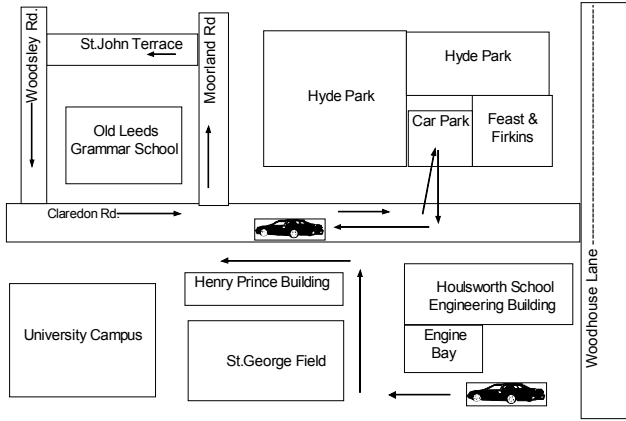

TEST PRECEDURE –The whole journey (4 laps) took about 14~16 minutes with cold start. Eight bags of exhaust samples were collected for each test, with two bags for each lap, one for upstream and one for downstream of the TWC.

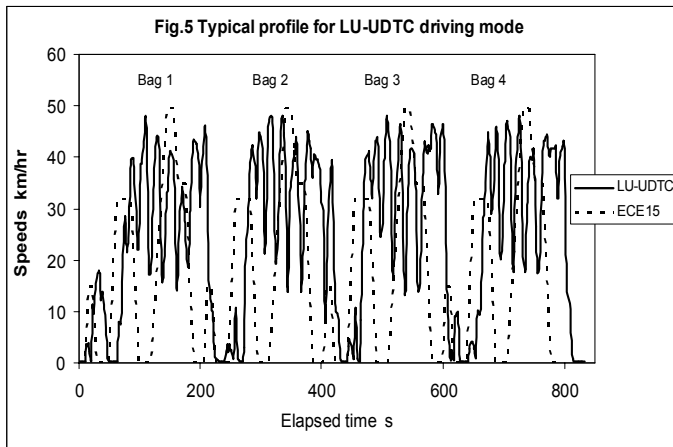

WARM-UP OF THE ENGINE AND EXHAUST SYSTEM

The engine out cold start influence on emissions is mainly due to the thermal inertia of the engine and the water and lubricating oil systems (9–12). The cold start influence on the catalyst performance is mainly due to the thermal inertia of the exhaust manifold, the downpipe and the underfloor catalyst. It was therefore important in this real world urban driving study of the influence of ambient temperature on cold start emissions, that the temperatures of the key engine and exhaust temperatures were recorded.

Two sets of typical results are presented below to show the comparison of engine and exhaust system between winter and summer. The coldest (-2°C) and hottest (31.5°C) ambient temperature test results are compared.

WARM UP OF COOLANT WATER AND ENGINE OIL - Figs.6-8 show the comparison of the warm up rate between winter and summer for the coolant water and engine lubricating oil. The results show that for LU-UDTC cycle in summer time the coolant water temperature reached the fully warmed-up value, when the thermostatic control valve opened, after four minutes. This was about five minutes earlier than that in winter. The lubricating oil temperature reached the full warmed-up value in ten minutes in summer, six minutes earlier than that in winter. The full warm up of the water was taken as when the temperature of the water outlet from the engine reached 88°C and the thermostatic valve opened. This caused the temperature to decrease as the cold water in the radiator was added to the cooling water circulation.

The warm up period of the lubricating oil was taken as when the lubricating oil reached 80°C. Two lubricating oil temperatures were measured (T20 and T21), one close to the surface of the lubricating oil (dipstick, T21) and one close to the bottom of the sump (T20). The top temperature is higher than the bottom as the oil from its circuit around the engine is heated and hence accumulates on the top of the sump oil level. The oil pump picks up cold oil from the bottom of the sump. Hence the true lube oil warm-up temperature is that for the bottom of the sump (T20).

The difference in these temperatures is shown in Figs. 7 and 8, which shows a much longer warm-up period for the oil at the bottom of the sump and a much greater difference in this temperature between winter and summer, than for the corresponding difference for the top of the sump oil temperature (T21). The comparison in Fig. 6 is for the top of the sump temperature (T21). This temperature difference between the top and bottom of the oil sump was also found in engine dynamometer warm-up tests (9-14).

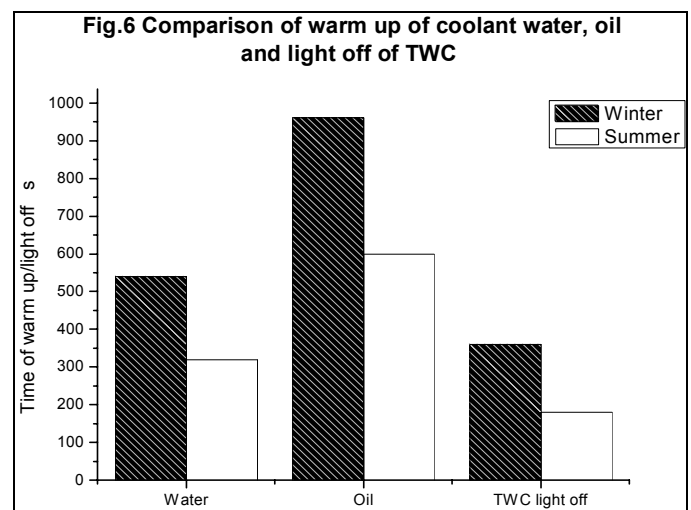

These results show that in summer the water is not warm until the middle of the second lap and in winter this

occurs in the middle of the third lap. For lubricating oil in summer the bottom of the sump oil warms-up at the end of the fourth lap and in winter it is not warmed-up by the end of the fourth lap. For the short urban journeys that are common in cities such as Leeds with a high population density (1,300/km²) these results show that the slow warm-up of the water and lubricating oil are a significant factor in the higher engine out emissions and fuel consumption under cold start, which are detailed below. Normally, the lube oil is unlikely to warm up in any short urban journey and this has a major impact on the higher fuel consumption in urban driving.

outlet metal temperatures. This shows that it takes 200s to reach 300°C at 31°C ambient temperature, by which time the exhaust port temperature is 600°C. This is roughly the time constant for the thermal inertia of the exhaust manifold.

The downpipe has further thermal inertia and Fig.9 shows that after 200s from the cold start the wall metal temperature upstream of the catalyst is only 170°C at 31°C ambient temperature and 130°C at -2°C. It is this slow heating of the exhaust system walls that extracts heat from the exhaust and causes the catalyst inlet temperature to be well below its light off temperature.

Figs.10 and 11 show for winter and summer conditions, the front face and rear face catalyst substrate temperatures on the center line and left hand side. The two temperatures were very similar for each face, although at the rear face when the catalyst was lit off one of the thermocouples was 50°C higher than the other, indicating a spatial non-uniformity in the activity of the catalyst. This occurred in the winter and summer tests. When the catalyst is active the heat release from the oxidation of hydrocarbons and CO increases the gas and substrate temperatures.

One method of determining the catalyst light off temperature is when the downstream catalyst substrate face temperature is greater than the front face temperature. Fig.6 shows that time that this occurs for the summer and winter test conditions. This time is approximately twice as long in winter as in summer. Comparison with Fig.5 shows that the catalyst light off occurs just at the end of the first cold-start street circuit and in winter it occurs at the end of the second street circuit or about 3km. Many journeys in urban areas such as Leeds are less than 3 km and under these conditions Euro 1 vehicles in winter have little catalytic exhaust emissions clean up.

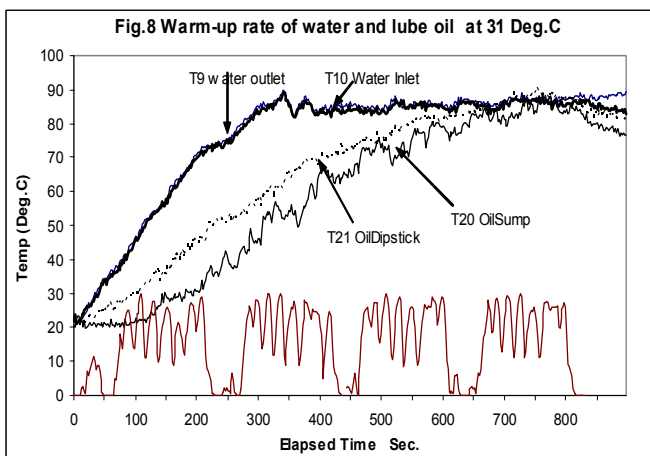
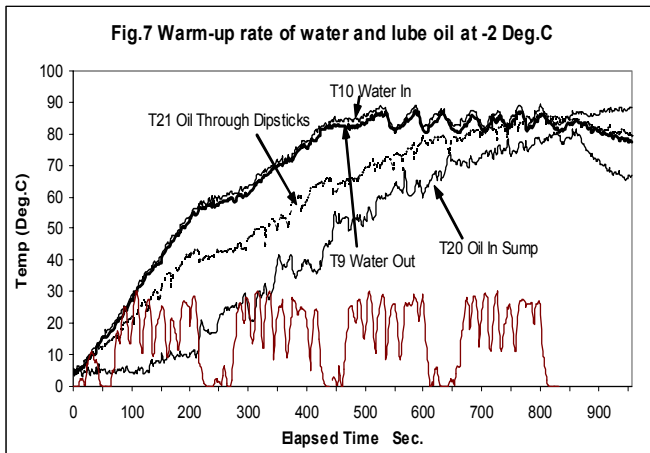

CATALYST INLET AND FACE TEMPERATURES AND LIGHT OFF – Fig.9 compares at 31 °C and -2°C ambient temperature the downpipe metal temperatures at the inlet (Tw22) and outlet (Tw24), which is just upstream of the catalyst connection flange. In these tests the engine exhaust port temperature was at least 350°C within 10s of the cold start and never dropped below 450°C after 60s from the -2°C cold start. All these exhaust port temperatures are above the light off temperature of a catalyst. The slow light off temperature of a catalyst in a Euro 1 vehicle is thus due to heat losses in the cold manifold and downpipe. The cold manifold heat losses dominate initially, as shown by the downpipe inlet metal temperatures in Fig.9, which are close to the manifold

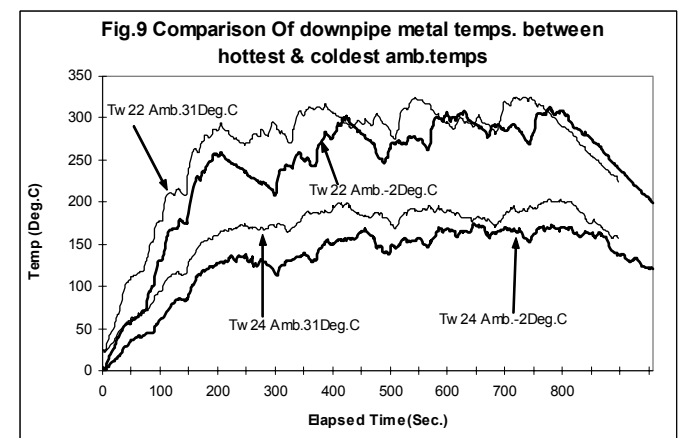

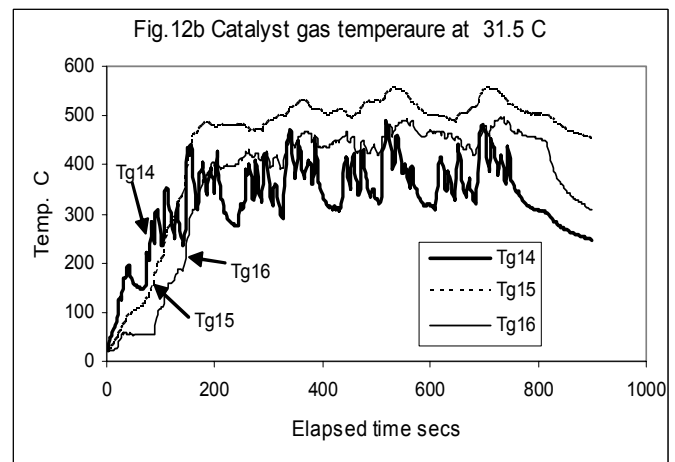
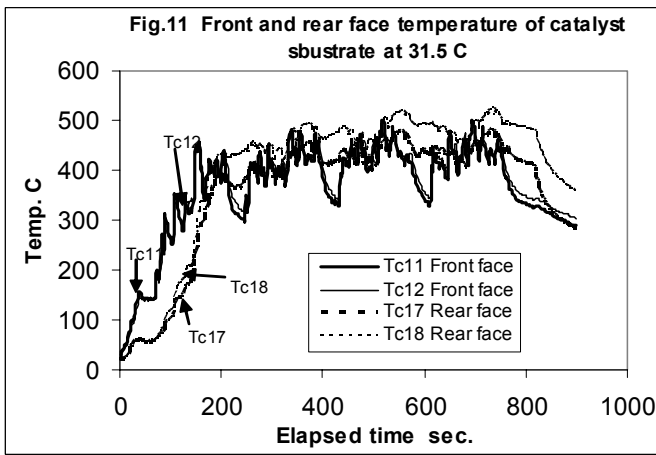
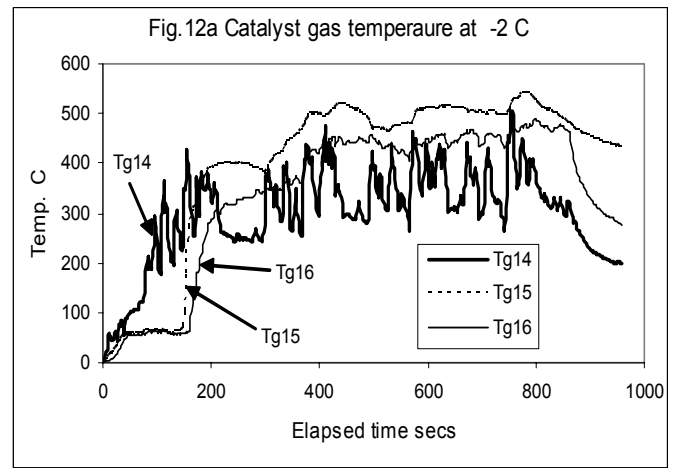
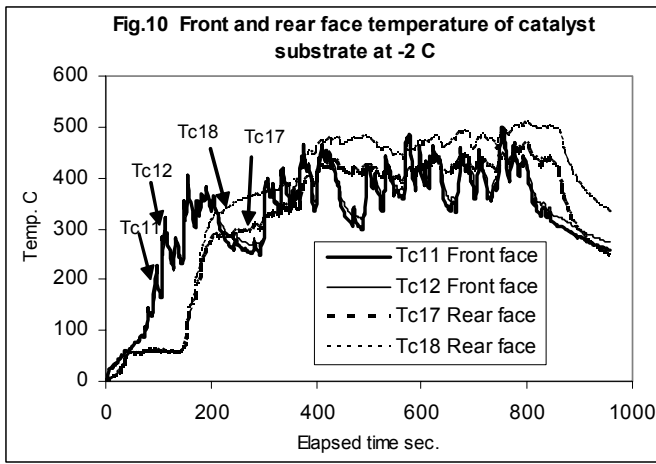

The gas temperatures were measured at the catalyst inlet (Tg14), between the two catalyst bricks (Tg15) and downstream of the catalyst (Tg16). The advantage of using these temperatures to determine the catalyst light off is that under cold start only the first catalyst brick is normally active, due to the lower exhaust mass flow rates at the low powers of the cold start urban cycles. Thus it is normally only the first brick that is heated in the first light off phase and hence the second brick acts as a thermal heat sink. This means that the downstream catalyst brick face may not be the best location to determine the catalyst light off. The centre thermocouple located between the two bricks is likely to be the best place to determine the catalyst light off using the temperature rise from catalytic activity.

The catalyst gas temperatures Tg14,15 and 16 are shown in Fig.12a and b for winter and summer conditions. These results confirm that the central temperature between the two bricks rises to the highest temperature and demonstrates a clear catalyst light off, when compared with the inlet gas temperature. This central temperature is higher than the downstream temperature for most of the test period, indicating the effect of the thermal inertia of the downstream brick.

The catalyst light off temperature was determined as the time at which the central gas temperature thermocouple T15 became hotter than the inlet gas temperature. The summer and winter light off times are compared in Fig.13. Comparison with Fig.6 show much lower light off times, by a factor close to 2. Also, there is a lower difference between summer and winter using the central gas thermocouple. Essentially, the light off time in Fig.13 is for the front brick and the light off time in Fig.6 is for the rear brick. This can also be shown by comparing the time at which the downstream gas temperature T16 is continuously hotter than the inlet. Figs.12a and 12b show that this is at 360s in winter and 200s in summer, in excellent agreement with the inlet and outlet catalyst face temperature light off times in Fig.6. For cold start emissions control it is the light off of the first brick that is important, but having both bricks active is important in terms of achieving the best catalyst conversion efficiency.

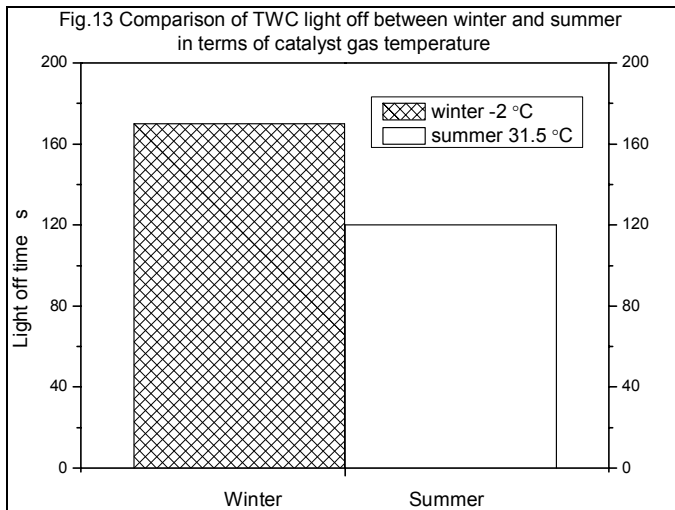

COMPARISON WITH EURO 3 REGULATIONS

The overall fuel consumption for the four laps of the Leeds urban drive cycle was 13.9 liters per 100 km under summer driving conditions. This measurement was not available for all tests as there was no accurate on board fuel consumption meter. It is considered that a comparison of the present emission results with the ECE test cycle standards should be done by converting the standards from units of g/km to g/kg fuel, using the test cycle fuel consumption for vehicles of this type. The fuel consumption for Ford vehicles with 1.8 litre Zetec engines are in the range 10.4 to 11.0 l/100 km, as shown in Table 3 below. An average value of 10.7 l/100 km will be used. Taking the fuel density to be 750 kg/m³ then the fuel consumption is 0.08025 kg/km. This is in reasonable agreement with the present measured value of 13.9 l/100 km, especially when it is taken into account that the EUDC cycle is not included in the present measurements. However, the greater number of acceleration and decelerations in the Leeds urban drive cycle is likely to increase the fuel consumption.

Table 2 presents the Euro 1, 3 and 4 emission limits converted into g/kg fuel. The Euro 1 legislation summed the HC and NOx, to get separate figures the Euro 3 HC/NOx ratio has been applied to the Euro 1 legislation and then converted into g/kg fuel using the above 0.08025 kg/km fuel consumption. It should be remembered that in the Euro1 test procedure the first 40s idle of the cold start was not sampled, whereas in the present tests all emissions after the first engine firing were sampled into the bag. This is why the present summer CO results are a little higher than would be expected for a Euro 1 vehicle.

Table 2 Comparisons with EURO 1, 3 & 4 legislation

	HC g/kg fuel	CO g/kg fuel	NOx g/kg fuel
Euro 1 g/km	0.97(HC+NOx) 0.55HC(Euro3 HC/NOx ratio)	2.72	0.42NOx(Euro3 HC/NOx ratio)
Euro 1 g/kgfuel	6.91	34	5.23
Euro 3 g/km	0.2	2.3	0.15
Euro 3 g/kgfuel	2.49	29	1.87
Euro 4 g/km	0.1	1.0	0.08
Euro 4 g/kgfuel	1.245	12.5	1.0
Leeds Average of 4 phases at -2 °C	11.61	181.7	3.04
Leeds phase 1 at -2 °C	34.11	519.7	3.15
Leeds phase 4 at -2 °C	1.37	10.6	2.40
Leeds average of 4 phases at 31.5°C	4.56	48.7	2.32
Leeds phase 1 at 31.5°C	11.76	146.6	3.14
Leeds phase 4 at 31.5°C	1.63	13.5	2.32

The mean of the 4 laps, i.e. the mean of the four bag samples, is most relevant for comparison with the ECE legislated emissions, as the ECE test procedures produce an average result for the first four urban cycles and also include an EUDC, which was not simulated in the Leeds urban street cycle. Only the samples downstream of the catalyst need to be compared. Table 2 shows that in summer the Leeds results for CO are higher than the standard but the HC and NOx results are lower. The lower NOx results are expected as the EUDC

part of the ECE test cycle was not simulated and significant NO_x is formed in this part of the test, but little CO and HC is usually formed here. The HC results would be a low because the sample system only measures HC that were gaseous after the ice bath condenser. The CO results were high because of the 40s ignored in the Euro 1 cold start test. Also, the constant flow rate sampling system would oversample the low power higher CO parts of the engine operation on the test cycle. In spite of these differences from the ECE test procedures the present in-vehicle real urban driving bag sample technique is showing good agreement with the legislated requirement for this vehicle.

A comparison with the Euro 3 and 4 legislations is made in Table 2 for the fully warmed up catalyst (Leeds Phase 4). This shows that without the cold start a Euro 1 vehicle will easily meet Euro 3 standards if the catalyst is hot. Even in winter the warmed up catalyst results in Table 2 meet the Euro 3 standard. Even Euro 4 standard is not very arduous for this Euro 1 vehicle, especially for CO emissions. Thus the difference between winter and summer conditions was entirely in the cold start phase and once the catalyst is hot the lower air inlet temperature in winter had no influence on HC and CO emissions. Essentially this is how Euro 3 standards have been met by manufacturers, using close coupled catalysts and engine management strategies to increase the exhaust temperature during cold-start.

REGULATED CO EMISSIONS AT -7 °C COLD START

In 2002 Europe introduced new regulations for low temperature tests, which cover -7°C cold start tests aimed at the determination of CO and HC emissions in the cold start phase. This is to promote the development of new technologies for further control of CO and HC emissions under winter cold start conditions. The new low temperature test is to be carried out at -7°C over 4 repeats of the urban driving cycle. The limits for CO and HC are 15 g/km and 1.8 g/km respectively for cars and light commercial vehicles (26). Similar regulations have also been introduced in the USA. These -7°C cold start regulations are converted into g/kg fuel in Table 3. To do this the published fuel consumption data over the ECE test cycle was used (27). Table 3 shows the fuel consumption data for a range of vehicles similar to the Ford Orion Euro 1 vehicle that was used in the present work. The data for 1.8 litre engine vehicles is most relevant for the present comparisons. However, it should be stated that Euro 1 vehicles were not designed and developed to pass the current -7°C cold start test.

In the present work the influence of ambient temperature on the first cold start was determined separately from

the influence over four cycles, as in the ECE cold start procedure. Thus the correct comparison with the new ECE cold start procedure is with the average of the four bags under cold ambient temperature conditions.

Table 3 Converted CO and HC European low temperature legislation for some FORD petrol cars

Car model	Fuel consumption litre/100km	Converted CO Limit at -7 °C g/kg fuel	Converted HC Limit at -7 °C g/kg fuel
Modeo1.4 L	6.6	303.03	36.36
Focus 1.6 L	6.7	298.51	35.82
Focus 1.8 L	10.4	192.31	23.08
Mondeo1.8L	11.0	181.82	21.82
Mondeo2.0L	11.5	173.91	20.87
Measured -7°C emission level		230	14.5

- N.B. 1. Fuel consumption data come from website of the Vehicle Certification Agency, UK.
 2. The fuel density is set as 750 kg/m³.
 3. The measured emissions for the Ford Orion on the Leeds urban cycle at -7°C cold start have been extrapolated from the cold start results as a function of temperature in the -2 to +15°C ambient temperature region where there is a linear dependence of CO and HC emissions an ambient temperature.

COMPARISON OF EMISSIONS BETWEEN SUMMER AND WINTER FOR WHOLE FOUR LAPS OF THE LEEDS URBAN TEST CYCLE

Each lap of the Leeds urban test cycle had an exhaust sample taken into a pair of bags. The composition of this represented the average emissions for that road journey. The detailed sampling procedures and their limitations have been discussed above. The emissions results are presented in the following graphs as a function of the number of the test cycles, from the cold start bag 1 through bags 2 and 3 to the last bag 4, which is normally representative of the emissions with a fully warmed up engine and catalyst. The simultaneous measurement of the engine and catalyst out emissions also enabled the catalyst efficiency to be determined for each lap of the urban test cycle.

The measured bag concentrations were converted to EI mass units, as discussed above. Crucial to this conversion is the bag air/fuel ratio, determined by carbon balance from the bag composition. Although in many tests the bag air/fuel was close to the stoichiometric value, it was normally leaner. This was due to two factors: firstly the engine management

involved fuel cut off during deceleration; secondly any small air leaks in the sampling system. The bag sampling system operated continuously and so sampled air when the engine was not fuelled. Also the condenser and filter unit were upstream of the sample pump and hence operated under negative pressure. This could result in small air leaks if the connections were not fully sealed, which could not be checked prior to the test apart from visual observation.

In either case the net result is that the bag sample is effectively diluted from the stoichiometric value that the engine management system tries to control the engine. This results in the leaner than stoichiometric mixtures in the bag samples. However, this simply dilutes the samples and in the conversion to mass this dilution is cancelled out by the air/fuel ratio term that increases linearly with any dilution. The bag samples were found to be overall leaner in summer than in winter. This was considered to be due to more fuel cut-off under warm conditions. However, this was not directly determined.

HYDROCARBON EMISSIONS - Fig.14 shows the comparison of HC emissions between summer and winter for upstream (dashed lines) and downstream (solid lines) of the TWC.

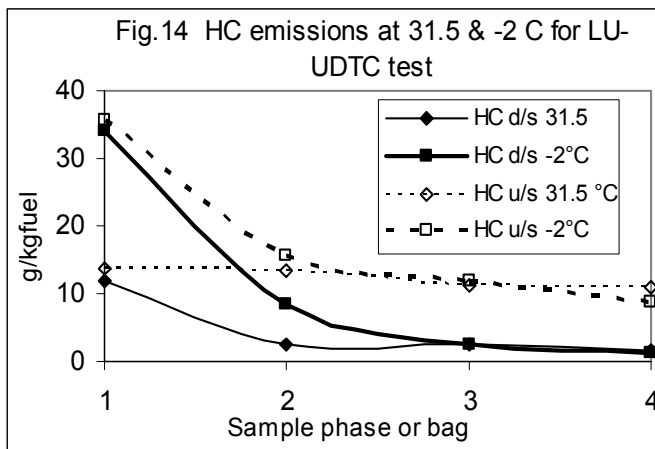

Fig.14 shows that under winter conditions there was a 60% in reduction in the engine out HC emissions between the cold-start first lap and the emissions during the second lap. This indicates the importance of engine water and lubricating oil warm up on the engine out cold-start emissions. A further reduction of 4.0 g/kgfuel in HC emissions occurred from the second phase to third phase of the test. For the summer test, the HC emissions decreased slowly from 13.9 to 11.0 g/kgfuel through four laps of the whole test cycle, showing a much lower influence of engine warm up.

Downstream of the TWC, there was a much stronger influence of the warm-up on HC emissions compared with that of the upstream emissions for the winter results. This was because of the additional influence of

the catalyst activity increasing with the warm-up time. The HC emissions decreased from 34.1 g/kgfuel in the first phase of the test to 8.5 g/kgfuel in the second phase of the test, a 75% in reduction in HC within the first 8 minutes. A further reduction of 6.1 g/kgfuel in HC emissions was seen from phase two to phase three of the test. The summer results a similar reduction of HC emissions in the first 8 minutes. The HC emissions decreased from 11.7 g/kg fuel of the phase 1 to 2.5 g/kg fuel of the phase 2, a 79% reduction.

The differences in the HC emissions between hot summer and cold winter were negligible from the third gas sample bag onwards. This shows that the ambient temperature effect on Euro 1 vehicle HC emission in urban driving is limited to the first 3 km. However, a very large proportion of the number of journeys in a congested compact city such as Leeds is less than this distance. Also all the morning and evening commuter journeys are under cold start conditions.

The catalyst conversion efficiencies for each lap of the Leeds urban drive cycle were evaluated from the simultaneously sampled bag samples. The results are shown in Fig.15. This shows the very poor conversion efficiencies during the first cold start lap with an increase in the efficiencies to 85% by the fourth lap. The difference between winter and summer is clearly shown by the lower efficiencies in winter with only the third lap showing 80% conversion efficiency.

The first bag HC -2°C cold start emissions downstream of the catalyst were 34.1 g/kg fuel and this is substantially higher than the new regulations allow for a -7°C cold start, as shown in Table 3. However, by the third lap the bag 3 results show that in winter or summer the HC emissions with a fully warmed up engine and catalyst were for this Euro 1 engine below the Euro 3 HC limits. The differences between Euro 1 and Euro 3 vehicles and winter and summer cold starts is all in the cold start phase of the test cycles and this has the greatest influence in real world driving in congested urban cities.

For the average of all four phases from the cold start, as in the ECE -7°C cold start the influence of the lower temperatures is much lower. The present results for average of the four phases has been extrapolated to -7°C using the normalization procedures discussed below, which is pessimistic as the temperature dependence is taken as that for the first phase. However, the results in Table 3 show that the predicted four phase average results at -7°C are higher than the -7°C standard for CO but similar for HC. Obviously the present Euro1 vehicle does not have the fast warm-up strategies used in Euro 3 vehicles, but the present results indicate that these -7°C cold start standards are not very arduous standards.

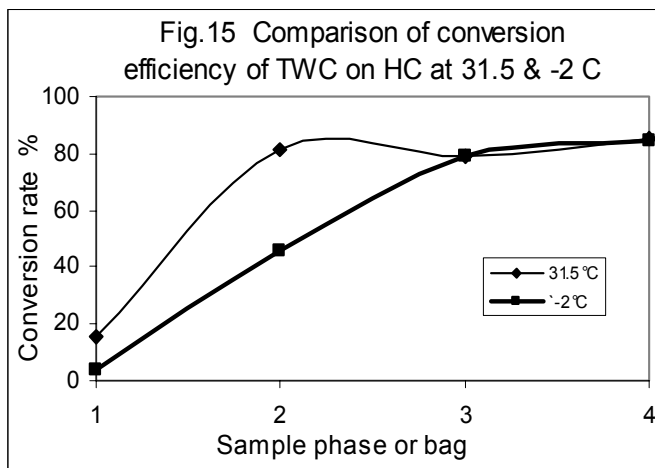

efficiency is a little higher. The main difference is in the bag 2 winter sample, where a lower conversion efficiency for CO was found.

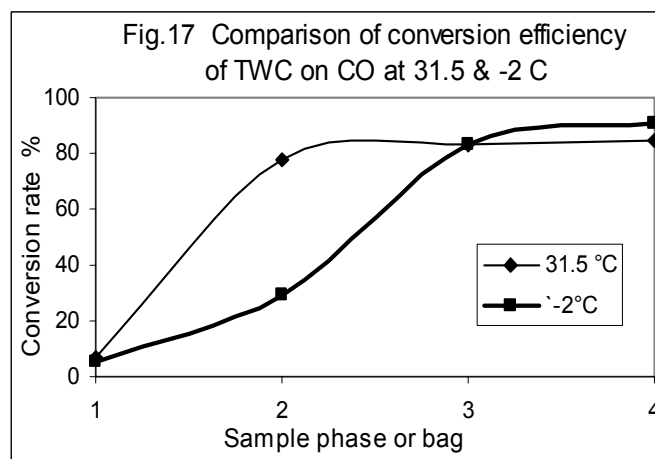

CO EMISSIONS – Fig.16 shows the comparison of the CO emissions for the Leeds urban drive cycle under winter and summer conditions. Upstream of the TWC for the winter test, CO emissions decreased from 551 g/kg fuel for the cold start phase to 249 g/kg fuel for the second lap, a reduction of 55% in the engine out CO emissions. A further reduction of 127 g/kgfuel (48%) occurred from the second phase to the third phase of the test. There was little change afterwards. For the summer test results, smaller changes in CO emissions were found. There was a decrease from 158 g/kg fuel for the cold start to 89 g/kg fuel for the second lap, a reduction of 44%. There were no further reductions in engine out CO emissions for the next two laps.

The -2°C cold start emissions for the first bag downstream of the catalyst were 520 g/kg fuel. This is well beyond the CO emissions regulation for -7°C cold start, as shown by comparison with the values in Table 3. This indicates that the new -7°C cold start HC and CO standard raised a problem with the present Euro 1 vehicle.

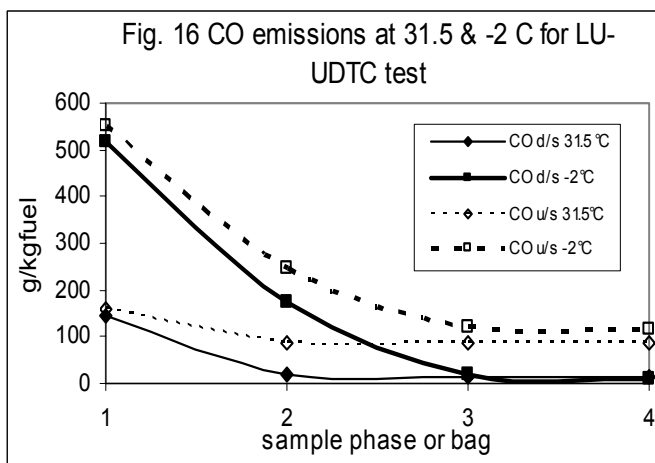

By the third lap of the Leeds urban drive cycle the results in Fig.16 show that the CO emissions downstream of the catalyst are very low at less than 25 g/kg fuel for both summer and winter cold start conditions. The results are shown in Table 2 to be well below those for the Euro 3 legislation. Hence, as concluded for the HC emissions, the problems of cold start and the influence of ambient temperature are eliminated once the engine and catalyst are warmed up. Also the differences between engine technologies for Euro 1 and Euro 3 are all connected with techniques to warm the catalyst up faster. Once the catalyst is hot a Euro 1 engine has a very similar emissions performance to a Euro 3 engine.

Downstream of the TWC, the winter results showed that CO emissions decreased continuously from the first phase to the third phase. The reductions were 344 g/kg fuel or 64% from the cold start lap one to lap two and a further 155 g/kg fuel or 88% from lap two to lap three.

Both summer and winter tests show similar trends in emissions. The data for lap 3 and 4 represent the emissions after warm up and are not affected by ambient temperatures. Very close HC and CO emissions for lap 3 and 4 between summer and winter tests could be used to illustrate that the repeatability of the tests is good.

Fig.17 shows the catalyst CO conversion efficiency determined from the simultaneously sampled upstream and downstream bag samples. The results are very similar to those for the hydrocarbon conversion efficiencies in Fig.15, although the final conversion

ENGINE OUT COMBUSTION INEFFICIENCY – Under cold start the engine out HC and CO emissions contain significant energy content and hence make a significant contribution to the fuel economy deterioration under cold start conditions. The CO and HC emissions have been converted from an emission index (g/kg fuel) into the equivalent energy content and then divided by the fuel energy input to generate the combustion inefficiency.

This is the combination of HC and CO mass emissions in energy terms. The results are shown as a comparison between winter and summer conditions in Fig.18.

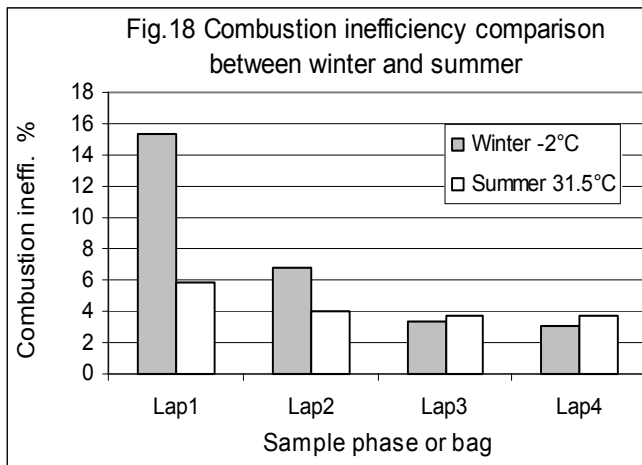
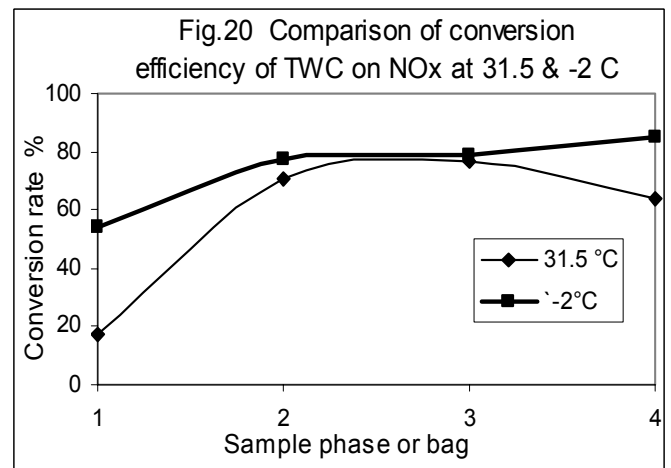
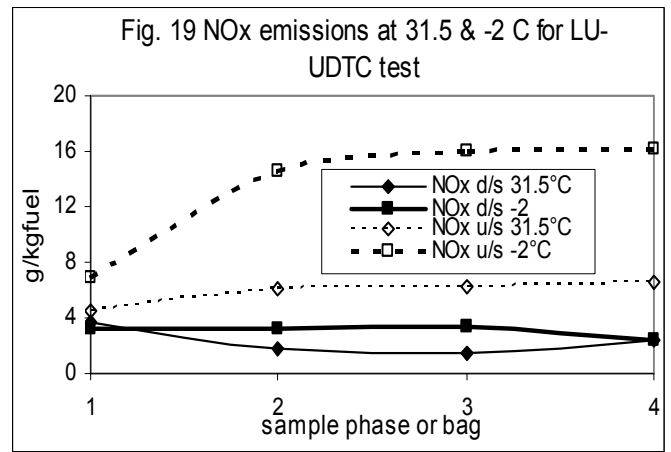

Fig.18 shows a major influence of the ambient temperature on the combustion inefficiency. 15% of the energy in the fuel is not released in the engine at -2°C cold start for the first lap of the Leeds urban street cycle. In summer this is down to 6%. Most of this inefficiency is due to the cold engine water, lubricating oil and piston temperatures during the first cold start. As shown above, in winter the water is hot by the end of phase 2 and the combustion inefficiency results show no further reduction for laps 3 and 4.

NOx EMISSIONS – Fig.19 shows the comparison of NOx emissions for the four laps for winter and summer tests. The catalyst upstream and downstream results are also shown. These results are quite different from the HC and CO results as engine out NOx emissions are reduced by cold starts. The lower air inlet temperatures and greater heat losses to cold surfaces both reduce the NOx emissions as they reduced the peak combustion temperatures. Thus the engine-out NOx emissions increase as the engine warms up. The increase was much greater in winter than in summer. It is considered that to overcome the higher engine friction with the colder lubricating oil, the throttle had to be further open and this would increase the NOx emissions relative to those under summer conditions.

Cold start catalyst efficiencies, shown in Fig.20, are also higher than for CO and HC. Euro 1 engines operate rich for a minute or so from cold start and the catalyst is active for NO reduction with rich mixtures at a lower temperature than for stoichiometric mixtures.



N₂O EMISSIONS – N₂O emissions are not currently regulated but they are a powerful greenhouse gas that is of the order of 200 times stronger in its effect than CO₂ for the same concentration. TWC catalysts are known to convert NOx into N₂O during the warm-up phase and this conversion is strong in the temperature region of 250 – 360°C.

Fig.21 shows the comparison of nitrous oxide (N₂O) emissions for the engine out and catalyst out samples under summer and winter conditions. It should be noted that the mass of N₂O is significant and of the same order as the fully warmed up NOx emissions after the catalyst.

For winter test, N₂O emissions showed a stable level at around 0.5 g/kg fuel upstream of the TWC. N₂O emissions downstream of the TWC doubled in the second phase of the test and then decreased again in the third and fourth phase of the test. The sudden increase in the phase two was due to the increase of engine out NOx emissions coupled with the catalyst being at the optimum temperature for N₂O formation. The decrease of N₂O afterwards was due to the increase of temperature of TWC, which was over 350 °C.

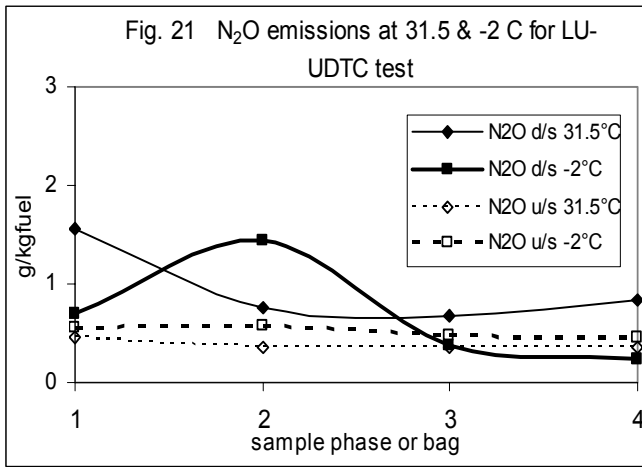

The results in the summer test showed no effect of the engine warm-up on the engine out N₂O emissions. After the catalyst the N₂O emissions were increased in the first cold start bag. This was because the catalyst was in the critical temperature range for N₂O formation during the first cold-start lap.

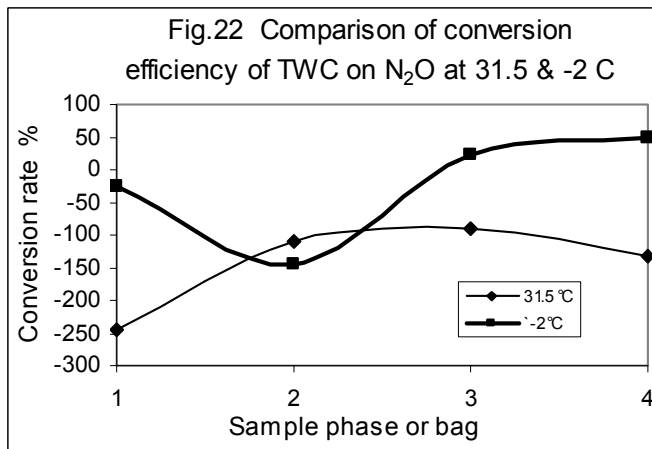

The formation of N₂O by the catalyst is seen as negative conversion efficiency when the results are expressed in terms of conventional conversion efficiency. These negative conversion efficiencies are shown in Fig.22. The N₂O formation problem is significant for the first 3 km in winter, but remained significant throughout the test period for summer conditions. The reasons for this are difficult to explain as the catalyst rear face temperatures in Fig. 11 is above 350°C during the later phases of the test and hence above the critical temperature for N₂O formation. However, it has been found in unpublished work by the authors that the N₂O formation is sensitive to the engine out NO/HC ratio and this is quite different under summer and winter conditions.

CO₂ EMISSIONS – The CO₂ emissions reflect the overall fuel consumption during the test cycles. The results in Fig.23 show that CO₂ emissions upstream of TWC in summer test was lower than that in winter test, indicating a lower fuel consumption. This was due to the

lower friction losses created by the higher lubricating oil temperatures in summer cold start conditions.

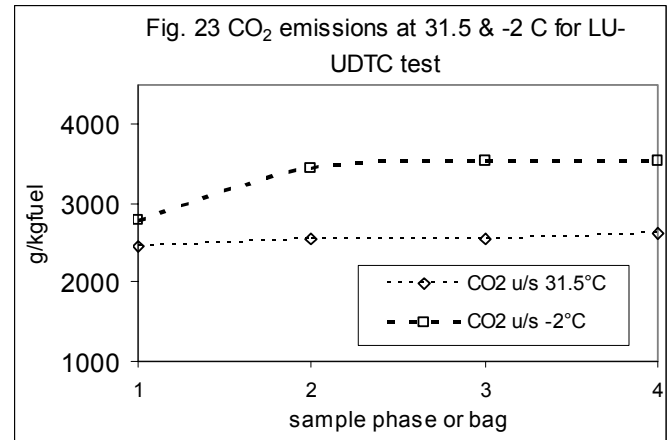

COLD START EMISSIONS AS A FUNCTION OF AMBIENT TEMPERATURE

The emissions in the first cold start lap of the Leeds urban test cycle had the highest catalyst out emissions for HC and CO, as discussed above. These cold start emissions were investigated as a function of ambient temperature. The trends of CO and HC emissions as a function of temperature will allow extrapolation so the –7°C cold start emissions can be predicted and compared with the standards in Table 3.

HC EMISSIONS - Fig.24 shows the hydrocarbon emissions as a function of ambient temperature for the cold start phase of the Leeds Urban test cycle. The curve fit results show a clear trend of hydrocarbon emissions in inverse proportion to ambient temperature over the temperature range from 15 to –2°C both upstream and downstream of the TWC. There was minimal catalytic activity and the trends are thus controlled with the engine out emissions and the factors that influence water and lubricating oil warm up.

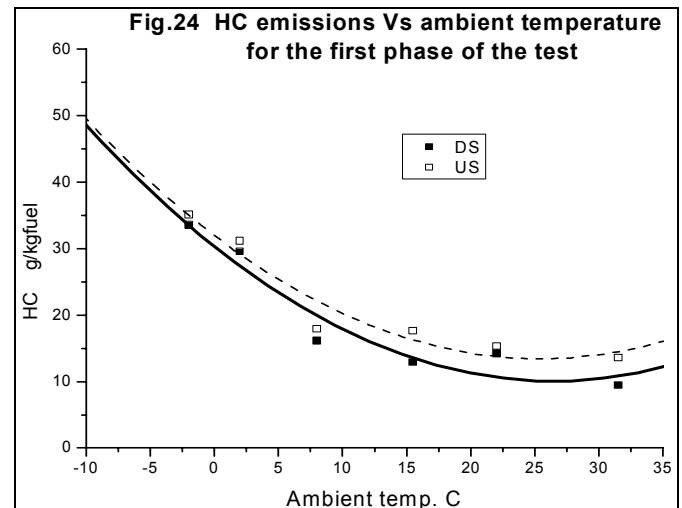

The HC emissions at -7°C can be predicted by extrapolation of curve fit in Fig.24 and the result is 45 g/kg fuel for HC. Comparison with Table 3 shows that this is well above the allowable -7°C cold start regulations. Euro 1 vehicles do not have to meet these regulations and the faster warm-up of the catalyst that is inherent in the design of Euro 3 compliant engines, should make the regulations in Table 3 easier to meet. However, these results show that in winter cold start hydrocarbon emissions will be a major problem as these HC emissions are 20 times the level for a Euro 1 engine with a fully warmed up catalyst. Hence, these cold start effects are only important in urban driving, where cold starts occur. Hence, they are very relevant to air quality concerns in congested cities such as Leeds.

CO EMISSIONS – The cold start CO emissions showed a similar trend with ambient temperature to that of the HC emissions as shown in Fig.25. The influence of ambient temperature on CO emissions was greater than that on HC emissions. This was due to the nature of combustion process in SI engines. CO is an equilibrium combustion product for rich mixtures and rich mixtures are used under cold start conditions in Euro 1 SI engines. Equilibrium CO emissions can be as high a 10% for mixtures that are 50% rich. The extent of the cold start over fuelling usually increases as the ambient temperature decreases. These equilibrium effects are in addition to any combustion inefficiency sources of CO emissions, which are related to the sources of HC emissions.

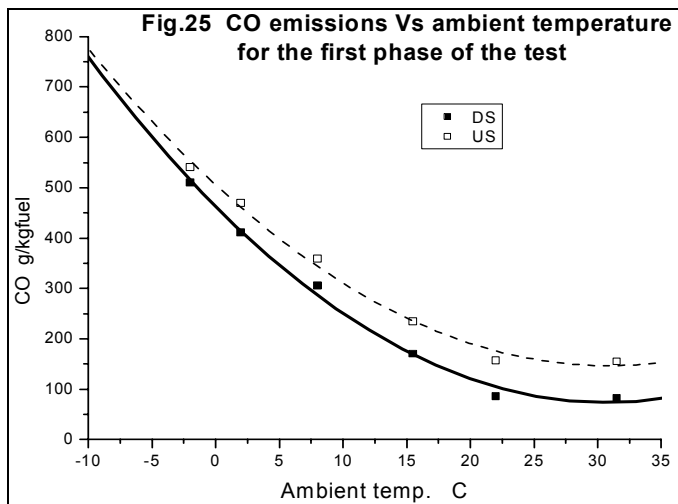

The cold start CO emissions as a function ambient temperature in Fig.25 may be extrapolated from curve fit to enable the emissions at -7°C to be determined. This is done in Fig.25 and the results are cold start CO emissions of 690 g/kg fuel. Comparison of this result with the legislated levels is made in Table 3 and this shows that these levels are well above the legislated levels by a factor of 4. Thus the new -7°C cold start CO standard is arduous to Euro 1 vehicles.

NOx EMISSIONS - Fig.26 shows the NOx emissions as a function of ambient temperature for the cold start phase of Leeds urban test cycle. The NOx emissions with curve fits showed a different trend to those for HC and CO emissions. There were no consistent trends with temperature for both engine out and catalyst out emissions. The reason was that engine out NOx emissions are reduced by cold conditions as the engine metal, water and lubrication oil temperatures are all cold and this cools the combustion, which decreases the NOx formation. Counteracting this trend is the increase in NOx due to the higher throttle angles required to overcome the increased friction losses as the ambient temperature becomes cooler. Set against these trends is the increase in the catalyst activity for the rich mixtures used in cold starts, as the catalyst is warmed-up.

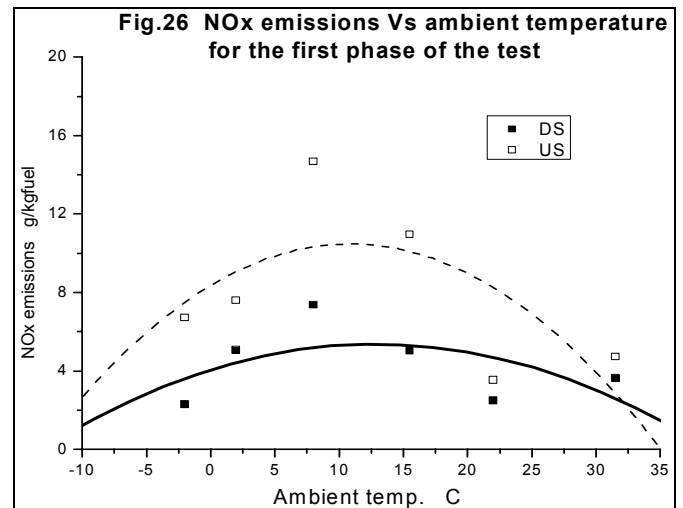

N₂O EMISSIONS - There were only small changes in N₂O emissions with ambient temperature upstream of catalyst. The curve fits shown indicate a small decrease in emissions as the ambient temperature increased, as shown in Fig.27. However, downstream of the catalyst there was a major impact of the ambient temperature on N₂O emissions. Increasing the ambient temperature resulted in the production of N₂O by the TWC, as shown in Fig.27. The N₂O emissions were more than doubled downstream of the catalyst for the most of ambient temperature conditions except -2°C . This was because as the ambient temperature increased under cold start conditions the temperature of catalyst was in the N₂O formation range ($250\text{--}350^{\circ}\text{C}$). At the -2°C cold start condition the catalyst was too cold in the first test and reached the critical temperature region for N₂O production during the second lap, as shown above.

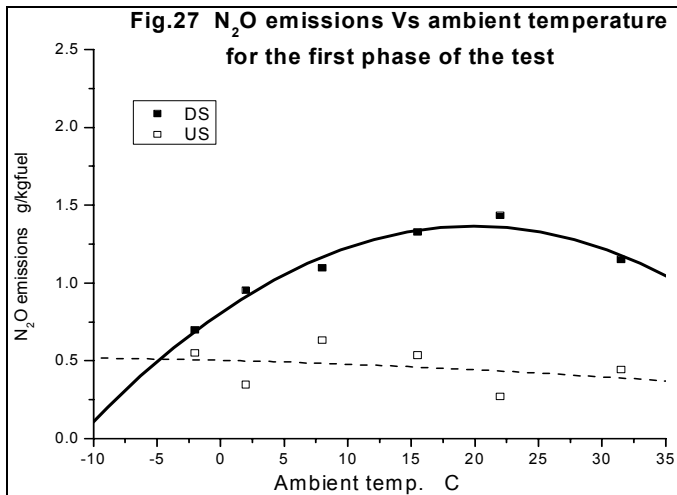

CO₂ EMISSIONS – Fig.28 shows the CO₂ emissions as a function of ambient temperature for the first phase of Leeds urban driving test cycle. The curve fit indicates that CO₂ emissions upstream of TWC were decreased slightly with the increase of ambient temperature, due to the better fuel economy in summer. This was mainly due to the lower friction as the lubricating oil heated up faster under higher ambient temperatures, as shown earlier.

CO₂ emissions downstream of TWC increased with the rise of ambient temperature as the time for the light-off of catalyst was shortened and the efficiency of catalyst was improved and thus more CO and HC were oxidized into CO₂.

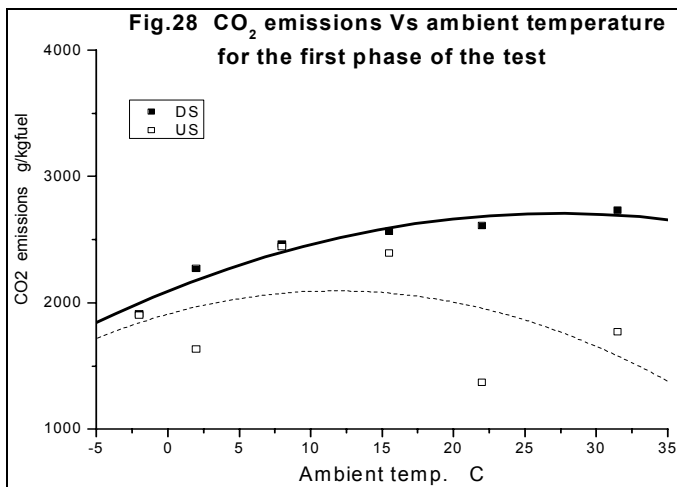

THE CONVERSION EFFICIENCY OF TWC – The catalyst conversion efficiency for HC, CO and NOx during the cold start phase of the Leeds urban driving test cycle was calculated by using upstream and downstream emission data. The results with curve fits are shown as a function of the ambient temperature in Fig. 29.

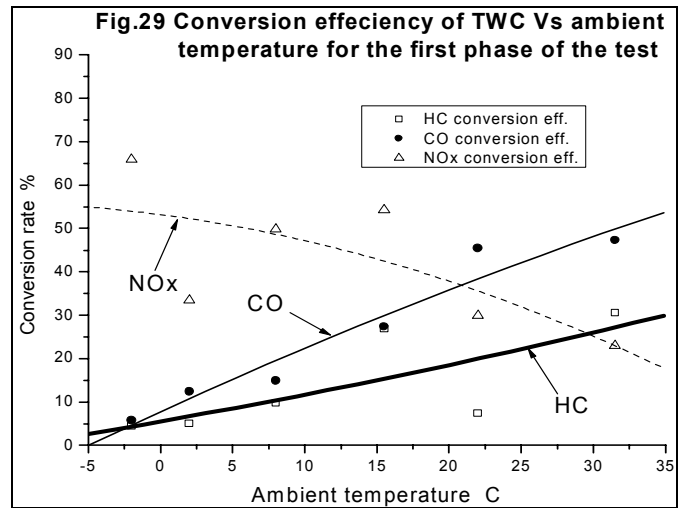

The catalyst conversion efficiency for HC and CO increased with increase in ambient temperature and the effect was stronger for CO. This was because the catalyst heated up faster as the ambient temperature increased. This was due to the reduction in temperature of the engine and exhaust metal components and the reduction in the coolant and lubricant temperatures as the ambient temperature decreased.

In contrast with the trend of HCs and CO, the conversion efficiency of the catalyst for NOx decreased with the increase of ambient temperature. When ambient temperature increased from sub-zero in cold winter to 30°C in hot summer, the conversion efficiency of NOx within the first four minutes of cold start was decreased from 50% to 20%. This was mainly due to the increase in engine out NOx at low temperatures due to the greater throttle angle necessary to overcome the higher friction losses with the cold lubricating oil.

To extend the prediction of CO and HC emissions at -7°C to other engines, the CO and HC emissions as a function of ambient temperature were normalized to the value at 25°C. Thus the CO and HC emissions at -7°C can be calculated from the values at 25°C, in which the emissions tests are normally conducted. Assuming that the influence of ambient temperature on emissions is the same relative effect as found in this work the emission for any vehicle could be predicted at lower ambient temperatures. The results with curve fits are shown in Fig.30. The HC emissions at -7°C are predicted to be nearly five times as high as those at 25°C. The CO emissions are predicted to be nine times as high as those at 25°C.

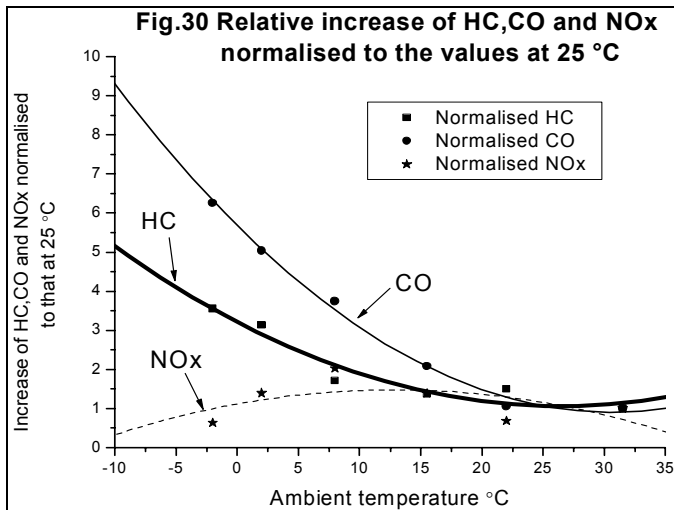

CONCLUSIONS

The Leeds urban street driving cycle test was similar to ECE15 urban cycle and yet represented real world driving patterns in the minor roads of congested cities.

1. The direct exhaust dry gas bag sampling technique was shown to give sensible mass emissions results and the performance of the tested Euro 1 vehicle under summer temperature test conditions was in agreement with the Euro standards.
2. The engine needed at least 5 minutes after cold start to reach full warmed up condition in terms of the coolant water temperature and 10 minutes in terms of engine oil. A decrease in the cold ambient temperature increased this period significantly.
3. The shortest time for the light off of the TWC was three minutes after a cold start in hot summer temperatures. The time required for the light off of TWC in cold winter was doubled.
4. Comparison of emissions between summer and winter tests showed that the first bag of gas samples (taken in the first 4 minutes after the cold start) had the highest emissions. This first cold start phase of urban driving test played a more important role on emissions than next three phases.
5. The significant differences of emissions between cold winter and hot summer were seen during the first and second phase of the test, particularly the first phase of the test. When the engine was fully warmed up there were little differences on HC, CO and NOx emissions between summer and winter conditions.
6. HC emissions were reduced by a factor of 5 downstream of the TWC during the cold start phase of the test when ambient temperature increased from -2 to 31.5°C.

7. CO emissions in the first phase of the test were reduced by a factor of 9 (downstream) when temperature rose from -2 to 31.5°C
8. There was no correlation between NOx emissions and ambient temperature
9. N₂O emissions upstream of TWC did not vary with ambient temperature during the engine cold start but were mainly affected by activity of TWC, which increased the N₂O emissions as the ambient temperature increased.
10. The conversion efficiency of the TWC during the cold start phase of the tests was increased by up to 50% for CO and 20% for HC when ambient temperature increased from sub zero to 30°C.
11. When this EURO 1 car was fully warmed up, the HC and CO emissions could meet the requirement of EURO 3 legislation on the Leeds urban driving test cycle.
12. This Euro 1 vehicle could meet the Euro 3 -7°C cold start legislation for HC emissions but not for CO emissions. This indicated that low temperature legislation at -7°C is very arduous for CO and HC emissions.

ACKNOWLEDGEMENTS

We would like to thank the UK EPSRC for a research grant, GR/M88167/01, for a JIF (Joint Infrastructure Fund) award for the LANTERN project (Leeds health Air quality, Noise, Traffic, Emissions Research Network). We would also like to thank the EPSRC for the research grant, GR/S31136/01, for the RETEMM (Real-world Traffic Emissions Measurement and Modeling) project award in support of this work. Grant Zhu would like to thank the University of Leeds for a research scholarship. James Wylie would like to thank the EPSRC for a studentship.

REFERENCES

1. Hans Peter and Christian Cozzarini: Emissions and Air Quality. SAE Reference book R-237.2000.
2. J.Laurikko, L. Erlandsson and R.Arbrahimsson; Exhaust in Cold Ambient Conditions: Considerations for a European Test Procedure. SAE Paper 95923.
3. J.Laurikko and P.Aakko: The Effect of Ambient Temperature on the Emissions of Some Nitrogen Compounds: A Comparative Study on Low-Medium and High Mileage Three-Way Catalyst Vehicles. SAE Paper 950933.

4. M.D.Gurney and J.R.Allsup: Predictability of Emissions from In-Use Vehicles at Low-Ambient Temperature and Alternate Driving Cycle Based on Standard Tests. SAE Paper 890625.
5. R.E.Larson: Vehicles Emissions Characteristics under Cold Ambient Condition. SAE Paper 890021.
6. G.W.R.Taylor and S Stewart: Cold start Impact on Vehicle Energy Use. SAE Paper 2001-01-0221.
7. J.Laurikko and N.Nylund: Regulated and Unregulated Emissions from Catalyst Vehicles at Low Ambient Temperature. SAE Paper 930946.
8. D.H.Jason and M.D.Checkel: Quantifying Vehicle Emission Factors for Various Ambient Conditions using an On-Road, Real-Time Emissions system. SAE Paper 2003-01-0301
9. G.E.Andrews, J.R.Harris and A.Ounzain: Transient Heating and Emissions of an SI Engine during the Warm-up period. SAE Paper 880264.
10. G.E.Andrews, J.R.Harris and A.Ounzain: SI Engine Warm-Up: Water and Lubricating Oil Temperature Influences. SAE Paper 892103.
11. G.E.Andrews, J.R.Harris and A.Ounzain: The Role of Cooling Water and Lubricating Oil Temperature on Transient Emissions during SI Engine Warm-up. I.Mech.E. 1989.
12. G.E.Andrews, J.R.Harris and A.Ounzain: Experimental Methods for Investigating the Transient Heating and Emissions of an SI Engine during the Warm-up Period. I.Mech.E. 1988.
13. G.E.Andrews, A.Ounzain, A.D.Al-fawaz, M.Ghazhikhani and P.H.Dyke: Catalyst Performance during the Warm-up period. 2nd British-Italian conference in Engine
14. G.E.Andrews, J.R.Harris and A.Ounzain: The Influence of External Heat Losses on the Transient SFC and Emissions during the Warm-up period of an SI Engine. IMechE 1990
15. B.Piotr and M. Jerzy: Cold Start Emissions Investigation at Different Temperature Conditions. SAE Paper 980401.
16. G.E.Andrews and F.M.Ahmad: The Composition of Spark Ignition Engine Steady State Particulate Emissions. SAE Paper 1999-01-1143.
17. G.E.Andrews, Hu Li, J.Hall, A.A.Rahman and P.Mawson: The Influence of an Oil Recycler on Emissions with Oil Age for a Refuse Truck in Service testing. SAE Paper 2001-01-0623.
18. G.E.Andrews, Hu Li, J.Hall, A.A.Rahman and P.Mawson: Impacts of an on Line Bypass Oil Recycler on Emissions with Oil Age for a Bus in Service testing. SAE Paper 2001-01-3677.
19. G.G.Zhu: Engine and Exhaust System Warm-up, Emissions and Catalyst Temperature Control. PhD thesis, Dept. of Fuel and Energy, The University of Leeds, 1999.
20. J.A.Wylie: Spark Ignition Engine Emissions during Cold Start under Real World Driving Conditions. MSc thesis. The University of Leeds, 2001.
21. Automotive Test Drive Cycles for Emission Measurement and Real-World Emission levels – A Review. Journal of Automobile Engineering, Vol.216, No.D7. Institution of Mechanical Engineers. London, 2002
22. Y.Ohyama: Mixture Formation during Cold Starting and Warm-up in Spark Ignition Engines. SAE Paper 960065.
23. P.Bielaczyc and J.Merkisz: Euro III/Euro IV Emissions – A Study of Cold Start and Warm Up Phases with a SI Engine. SAE Paper 1999-01-1073.
24. P.Bielaczyc and J.Merkisz: Exhaust Emission from Passenger Cars during Engine Cold Start and Warm-up. SAE Paper 970740.
25. P.Bielaczyc, J.Merkisz and J.Pielecha: Exhaust Emissions from Diesel Engine during Cold Start in Ambient Temperature Conditions. Paper presented at 2000 FISITA World Automotive Congress~Automotive Innovation for the New Millennium. Seoul, Korea, 2000
26. Spark Ignition Engine Emissions. Short course. Leeds University. 2003.
27. Website of Vehicle Certification Agency, UK. <http://www.vcacarfueldata.org.uk/>

ABBREVIATIONS

SI: Spark Ignition.

LU-UDTC: Leeds University Urban Driving Test Cycle.

TWC: Three Way Catalyst.

HC: Hydrocarbons.

CO: Carbon monoxide.

CO₂: Carbon dioxide.

N₂O: Nitrous oxide.