

 Open access • Journal Article • DOI:10.1086/133562

The keck low-resolution imaging spectrometer — Source link

J. B. Oke, Judith G. Cohen, Michael A. Carr, John Cromer ...+7 more authors

Institutions: National Research Council

Published on: 01 Apr 1995 - Publications of the Astronomical Society of the Pacific (IOP Publishing)

Topics: Imaging spectrometer, Spectrograph, Telescope, Cassegrain reflector and Field of view

Related papers:

- [Maps of Dust Infrared Emission for Use in Estimation of Reddening and Cosmic Microwave Background Radiation Foregrounds](#)
- [Maps of Dust IR Emission for Use in Estimation of Reddening and CMBR Foregrounds](#)
- [SExtractor: Software for source extraction](#)
- [The relationship between infrared, optical, and ultraviolet extinction](#)
- [UBVRI Photometric Standard Stars in the Magnitude Range \$11.5 < V < 16.0\$ Around the Celestial Equator](#)

Share this paper:    

View more about this paper here: <https://typeset.io/papers/the-keck-low-resolution-imaging-spectrometer-24etqsriiy>

The Keck Low-Resolution Imaging Spectrometer

J. B. OKE,¹ J. G. COHEN, M. CARR, J. CROMER, A. DINGIZIAN, F. H. HARRIS,² S. LABRECQUE,
 R. LUCINIO, AND W. SCHAAL

California Institute of Technology, Pasadena, California 91125
 Electronic mail: oke@dao.nrc.ca, jlc@astro.caltech.edu

H. EPPS AND J. MILLER

Lick Observatory, University of California, Santa Cruz, California 95064

Received 1994 November 16; accepted 1995 January 18

ABSTRACT. The Low Resolution Imaging Spectrometer (LRIS) for the Cassegrain focus of the Keck 10-m telescope on Mauna Kea is described. It has an imaging mode so it can also be used for taking direct images. The field of view in both spectrographic and imaging modes is 6 by 7.8 arcmin. It can be used with both conventional slits and custom-punched slit masks. The optical quality of the spectrograph is good enough to take full advantage of the excellent imaging properties of the telescope itself. The detector is a cooled back-illuminated Tektronics Inc. 2048×2048 CCD which gives a sampling rate of 4.685 pixels per arcsec. In the spectrographic mode the spectrograph has a maximum efficiency at the peak of the grating blaze of 32%–34% for the two lowest resolution gratings and 28% for the 1200 g mm⁻¹ grating. This efficiency includes the detector but not the telescope or the atmosphere.

1. INTRODUCTION

During 1988 a committee was set up to choose the first optical auxiliary instruments which would be built for the Keck 10-m telescope. Preliminary designs were developed for low-, medium-, and high-resolution spectrographs. When preliminary estimates of the cost of these instruments were obtained it was clear that only two of the instruments could be built. The Science Steering Committee decided that the low- and high-resolution spectrographs should be designed and built first. The initial design of the low-resolution instrument was supervised by Dr. J. Miller at Lick observatory. The final design and construction was done by the California Institute of Technology. It is this instrument, the Low Resolution Imaging Spectrometer (LRIS) that is described in this paper.

There were a number of design requirements and goals for the instrument. These include the following.

(a) The instrument should be capable of obtaining both low-resolution spectra and high-quality direct images since there was no plan initially for a Keck instrument devoted to imaging only.

(b) The instrument should be capable of making proper use of telescope images as small as 0.5 arcsec.

(c) The field of view should be as large as possible.

(d) At the lowest spectral resolution the instrument should be designed to work on very faint stars and galaxies. The noise should be dominated at all wavelengths by the sky background level.

(e) The highest spectral resolution should be sufficient to measure the velocity dispersion in unresolved star systems such as galactic nuclei.

(f) The spectral range of the instrument should be from 3100 to 10,000 Å.

(g) The instrument should have the minimum possible flexure.

(h) The instrument should have the maximum possible sensitivity and as little light loss as possible at the entrance slit.

(i) There should be as little vignetting as possible within the instrument.

(j) It should be possible to use a multislit or slit-mask technique to obtain many spectra simultaneously.

(k) There should be provision for a multifiber system.

(l) The instrument should operate at the Cassegrain focus rather than at the Nasmyth focus so that polarimetry and spectropolarimetry can be done efficiently.

(m) The instrument weight must conform to that allowed at the Cassegrain focus of the telescope. This is about 1400 kgm.

(n) There should be CCD cameras on the instrument for acquisition of and guiding on targets.

In order for the whole spectral range from 3100 to 10,000 Å to be observed simultaneously it was decided that the instrument should be a double instrument like the Double Spectrograph on the Hale 5-m telescope (Oke and Gunn 1982). The light from the object would be divided into blue and red components in the vicinity of 5500 Å using a dichroic mirror. The dichroic would reflect light below 5500 Å and transmit light above that wavelength. The two spectral regions would then be imaged with two cameras and two CCD detectors.

A double instrument has several advantages.

(a) The problem of overlapping orders is largely removed since the dichroic acts as an order-separating filter.

(b) The whole spectral region from 3100–11,000 Å can be covered in a single exposure.

(c) In the imaging mode two images at two different wavelengths can be taken simultaneously, which to a considerable extent avoids extinction problems when there is thin cirrus.

¹Now Visiting Astronomer, Dominion Astrophysical Observatory, 5071 W. Saanich Rd., Victoria, B.C. V8X 4M6.

²Now at Universities Space Research Association, U. S. Naval Observatory, Flagstaff Station, Flagstaff, AZ 86002.

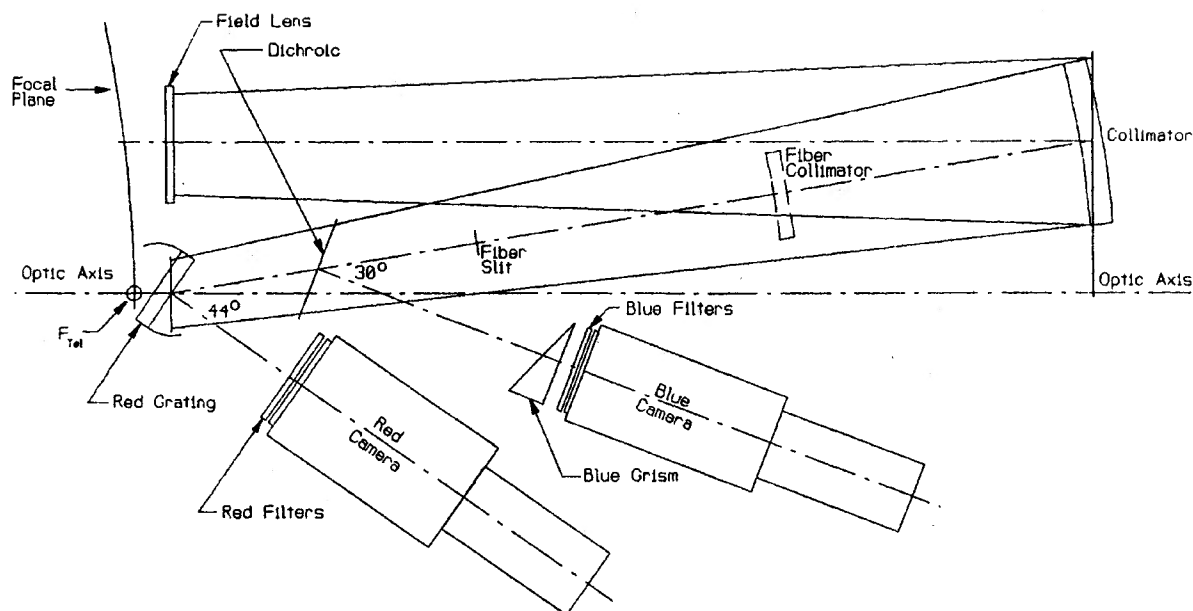

FIG. 1.—Schematic optical layout for the LRIS. The layout includes fiber-optic components, dichroic, and blue camera components which are not yet built. Note the location of the telescope optical axis relative to the LRIS field of view used. The collimator focal length is 2000 mm.

(d) The camera optics can have excellent antireflection coatings.

(e) The CCD detectors can be optimized for the limited wavelength coverage needed in each channel.

As the design of the spectrometer proceeded it became clear very quickly that the cost of the full instrument would exceed the allotted budget. It was therefore decided that there should be provision for the fiber system but it would not be implemented. It was also decided to carry out a preliminary design for the blue side of the instrument but not actually build it. Finally the decision was made that the detector would be a Tektronix 2048×2048 pixel back-illuminated CCD with 27 μm pixels even though such a device was still not available. This avoided the need to consider in detail mosaic CCD designs.

2. THE OPTICAL DESIGN

The Keck 10-m telescope is a Ritchey–Chrétien design. The Cassegrain focal length is 150 m so that the nominal focal ratio is $f/15$. The scale at the Cassegrain focus is 1.375 arcsec per mm. The radius of curvature of the focal plane is 2.180 m which presents serious problems for the spectrograph design. The field of view at the Cassegrain has a diameter of 20 arcmin or 0.873 m. Therefore any instrument with a field of 5 arcmin or more must have an entrance aperture of over 250 mm. Because the primary mirror is made of hexagonal segments the outer edge of the mirror is not round; the outer perimeter of the mirror has a diameter of 11 m which gives a real focal ratio of $f/13.7$. This faster focal ratio must be accommodated in the spectrograph design to avoid vignetting.

In order to maximize the throughput of the spectrograph and to keep the cost minimal, every effort was made to keep the spectrograph simple yet the performance excellent. The

design is shown in Fig. 1. The spectrograph employs a collimator, a dichroic mirror in the parallel beam, a grating on the red and a grism on the blue side, and a camera and CCD detector on each side. The mirror collimator reverses the light-travel direction and puts the parallel light onto a dichroic filter. The transmitted red and near-infrared light proceeds to a plane reflection grating which is located near the focal plane of the telescope. The diffracted light from the red grating comes off at a 44° angle to the incoming beam and goes through a lens camera. The blue light is reflected off the first surface of the dichroic and proceeds to a grism and a blue camera.

There are two additional optical elements in the design shown in Fig. 1. One is a field lens behind the entrance aperture which is discussed below. There is also provision for inserting filters in the parallel beams between the dispersing elements and the cameras. These are needed when the spectrograph is used for imaging and also when an order-separating filter is needed to limit the wavelength range in spectrographic observations.

The specifications and goals listed above along with the choice of CCD indicated that the beam size inside the instrument should be about 150 mm. The collimator focal length was then set at 2000 mm and the camera focal length at 305 mm. Since a field of 8 arcmin was desirable this meant that the collimator would have to have a diameter of about 500 mm. The only practical solution for the collimator was an off-axis parabolic reflector. The usual design for an off-axis parabolic collimator in which the focal plane is on the axis of the paraboloid was found to produce very bad images over the 6 by 8 arcmin field. An alternative design, where the axis of the parabolic collimator was coincident with that of the telescope and where the focal plane was off axis, was found to be excellent. This excellent performance is achieved at

A spectrographic lens is fundamentally different from the many varieties of photographic objectives (“camera lenses”) which are prevalent. The difference is that nearly all camera lenses contain an internal stop (where an iris is often placed) which creates a virtual entrance pupil. By contrast, the entrance pupil for a spectrographic lens is real and it is often located roughly one focal length or more ahead of the first lens element near the grating. This results in the need for relatively large lens-element diameters and it presents a unique aberration-control challenge. It might be said that the spectrographic lens is similar in its optical characteristics to a giant eyepiece used in reverse. However eyepieces never exhibit the fast focal ratio seen in the LRIS lens while at the same time their fields of view are almost always several times larger.

Approximately 67% of the positive power in the LRIS lens is contributed by the CaF_2 singlet. The relatively neutral triplet serves primarily to correct the chromatic aberrations of the singlet. It contributes only 10% negative power to the system. The doublet contributes about 59% of the positive power and partially corrects its own chromatic aberrations. Finally, the negative singlet serves primarily to reduce the Petzval sum and thus reduces the field curvature. However, by reason of its placement nearly an inch ahead of the focus, it contributes some 16% negative power and is thus not a “classical field flattener” although it will be referred to subsequently in this way. In practice the LRIS lens is not well corrected for third-order (von Seidel) aberrations. Its (under-filled) $f/1.56$ focal ratio requires these to be balanced against the higher-order aberrations in order to maximize the energy concentration in the images. The actual optimization of all the degrees of freedom, including the choice of glass types, was accomplished numerically by Epps.

In order to assess image quality, Run No. 1813 (4/05/89) was ray traced at infinite conjugate. The system was traced in 15 wavelengths at each of four field locations chosen to represent the on-axis point, 70% of the detector half-width, 100% of the detector half-width, and the full detector diagonal half-size. A 139.7×195.6 mm elliptical entrance pupil was used which represents the anticipated worst-case anamorphic grating magnification factor of 1.4. A back focal distance of 10.090 mm was maintained for all 15 wavelengths. This focal location was selected as the best average focus for the blue and visible portions of the spectrum. The upper portion of Fig. 3 shows the resulting rms image diameter (without refocus) as a function of wavelength for the four aforementioned field locations. It should be noticed that the color correction is somewhat undulatory which confirms the presence of first- and higher-order longitudinal chromatic aberration. However, the figure shows that at this particular focus, and under this extreme illumination condition, the camera produces images whose rms diameters are about $32 \mu\text{m}$ or less over the 3900–7000 Å chromatic interval.

The image quality evaluation is more severe than in reality because the anamorphic factor associated with a distribution of 3900–7000 Å light across the detector would be approximately 1.2 rather than the 1.4 value assumed for the calculation. If a higher-dispersion grating were used which produced an anamorphic factor of 1.4, the chromatic interval

across the detector would be less and a slight refocus could be employed to minimize the rms image diameters within the reduced chromatic range. Thus, one concludes that the camera’s image quality is adequate for spectroscopy within the 3900–7000 Å spectral region.

Passing to a redder chromatic range, the camera was refocused by moving the detector outward by 0.027 mm to a back-focal distance of 10.117 mm and the system was retraced at the previously mentioned wavelengths and field locations, with the 1.4 extreme anamorphic factor. The lower portion of Fig. 3 shows the resulting rms image diameter (without subsequent refocus) as a function of wavelength for the four field locations. In this case a broad 5200–10500 Å chromatic interval shows images whose rms diameters are less than about $32 \mu\text{m}$. The same considerations regarding the relationship between chromatic interval width, actual anamorphic factors, and refocus for chromatic subintervals at higher dispersion apply here as they did in the case of the 3900–7000 Å chromatic interval. One thus concludes that the camera has adequate image quality for spectroscopy in the 5200–10500 Å spectral region.

Lens elements for two nearly identical copies of the LRIS design were fabricated. These differ in minor detail from the nominal construction design, and from each other, in order to accommodate the specifics of “as-built” radii and thicknesses of the individual lens elements. The CaF_2 spherical elements were made by Janos Technology, Inc. using synthetic multicrystal boules grown by Optovac. The glass elements were made at the Lick Observatory Optical Laboratory using Ohara Corporation optical glass. The aspheric surfaces were polished by G. Pardeilhan and the precise optical figures were measured and confirmed using the Lick Observatory profilometer and data reduction system (Allen and Epps 1991).

The mounting of the lens components, shown in Fig. 4, is complicated because they are large and heavy and have different coefficients of thermal expansion. The CaF_2 elements are also very fragile. The barrel which holds the large singlet CaF_2 element was made of brass which has the same coefficient of thermal expansion as CaF_2 . The second barrel, which holds the triplet, is also made of brass to match the central CaF_2 element thermal-expansion coefficient. The small doublet barrel is made of steel. The small singlet double-concave field flattener is mounted in Delrin. The triplet and doublet components are optically coupled using Dow Corning Q2-3067 optical coupling grease. The thickness of the coupling layers is approximately $100 \mu\text{m}$. The individual components are centered at six points around the peripheral of each lens component. These six points are round fiberglass-filled teflon cylinders which are mounted in the slightly larger circular metal barrel in such a way that they are captured by the outer metal barrel. This arrangement keeps the lens components centered to about $25 \mu\text{m}$ which is adequate for the lens design. The singlet, triplet and doublet are defined absolutely in the axial direction on one of the front surfaces by a metal flange on the barrel. Between the metal flange and the glass is a washer of uncoated DuPont Kapton which is 0.076 mm thick. The other sides of the singlet, triplet, and doublet are held by a retaining ring. Be-

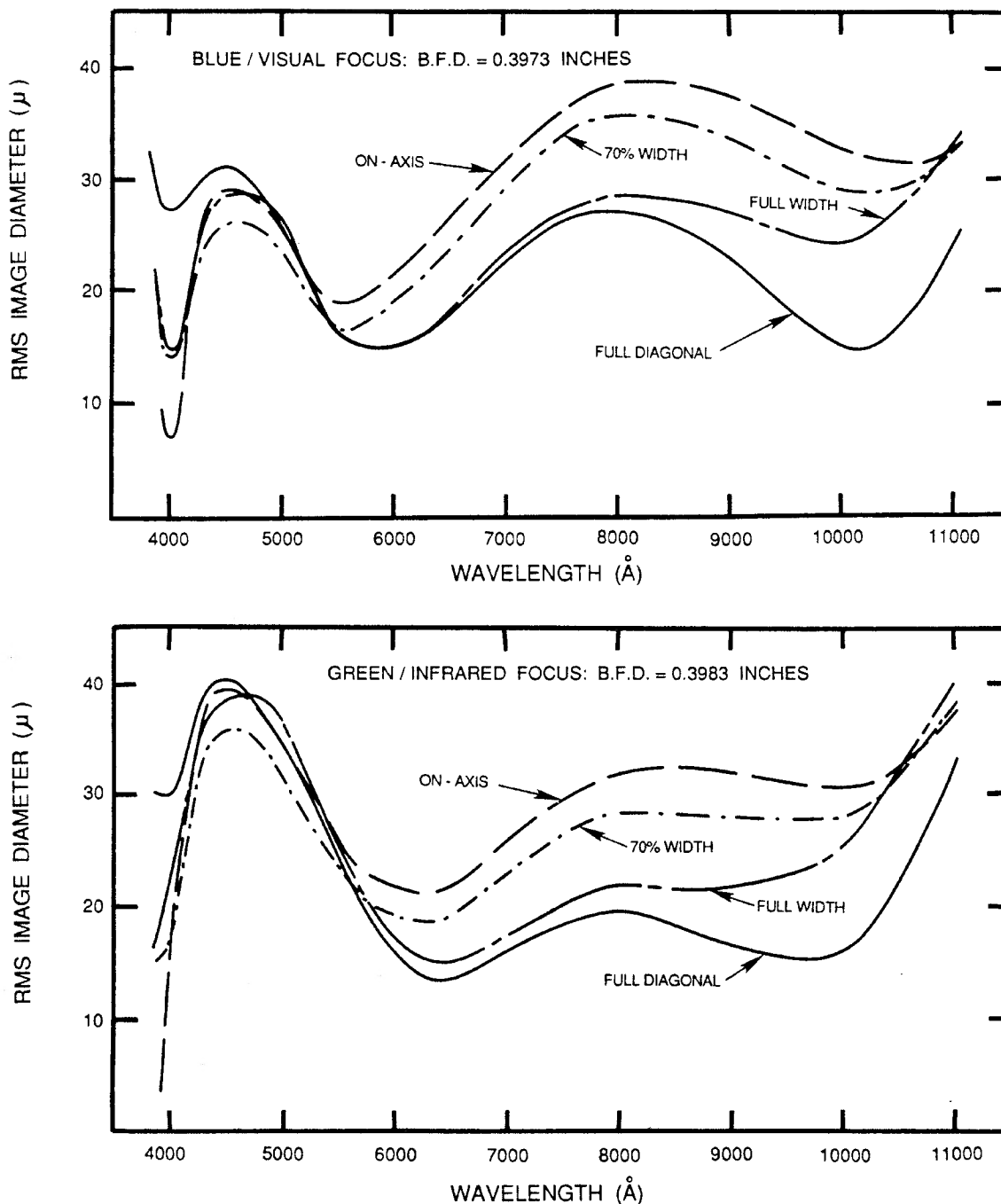

FIG. 3—Spectroscopic-image evaluation for the LRIS camera showing the expected rms image diameter as a function of wavelength for several representative field angles.

tween the retaining ring and the glass is a rubber o-ring of about 2.4 mm thickness. The spacing between the triplet and the doublet is defined by a long steel-spacer cylinder which produces the correct thermal-expansion coefficient. The doublet cell and steel spacer are held relative to the triplet cell by stiff springs. The various components of the lenses are mounted in an outer aluminum cylinder.

The remaining parts of the lens are the double concave 92

mm diameter field flattener and the 6.35 mm thick quartz Dewar window. An analysis of the thermal properties of the lens and mounting indicated that the small change in focus amounting to at most 0.1 mm due to temperature changes should be made between the doublet and the field flattener. Consequently the focus mechanism carries the field flattener and the Dewar with its vacuum window and CCD. The spectrograph shutter is also placed in front of the field flattener

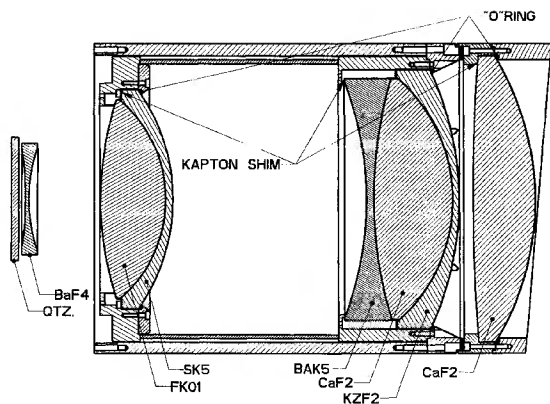

FIG. 4—The optics and mechanical mounting of the LRIS camera lens. The optical materials used are also shown. The quartz CCD Dewar window and field flattener shown on the left move relative to the remainder of the lens for final focus.

and on the part of the assembly which is moved for focusing.

The whole lens including coupling of the triplet and doublet was assembled in one day in California in an ambient temperature of about 20 °C. The lens has now been on the summit of Mauna Kea, where the ambient temperature is approximately 0 °C, for over one year. The only problem which has arisen is a minor separation in the coupling compound between one of the mated surfaces of the triplet which occurred during shipping, or more likely, upon arrival on Mauna Kea. Because such a problem was anticipated, the lens was shipped in a very well-insulated box with the intention that it would remain sealed in the box at the summit for several days to allow the lens to reach its new equilibrium temperature slowly. This schedule was not followed and the lens was exposed to the summit temperature abruptly. The separation is over a very limited area and is not enough to cause significant degradation in performance but it can be corrected by disassembling the lens and recoupling that surface. It should be noted that an identical lens made for the Norris Spectrograph at Palomar Mountain has performed completely satisfactorily for about two years even with the large summer-to-winter temperature excursions.

4. DICHROICS AND FILTERS

The dichroic mirrors, which have not yet been incorporated, are designed to reflect the blue and violet and transmit the red and near-infrared light. One potential problem is that a small fraction of the transmitted red light is reflected off the rear side of the dichroic substrate and returns through the dichroic layer into the blue camera chain. Because the beam going through the dichroic is parallel, this returned red light produces a ghost image or ghost spectrum which is exactly superposed on the blue image or spectrum provided that the two surfaces of the dichroic substrate are sufficiently parallel to each other. If this is so, there is no problem. In any case, the rear side of the dichroic substrate should have a multilayer antireflection coating put on it to keep the ghosts to no more than 1 percent. In the spectrographic mode the ghost image only exists at wavelengths where the dichroic is transmitting. This is at the extreme red end of the blue camera

spectrum. In the imaging mode the ghost image is absent provided that color filters are used that are properly blocked out to 11000 Å and provided that the dichroic crossover is not within a filter band.

Since filters are needed both for broadband imaging and possible order separation a decision had to be made where to put them. The first possibility was to put them near the CCD Dewar, probably just in front of the field flattening lens where there is some space available. The filters would have to be about 75 mm on a side. One problem would be the need to have all filters of the same optical thickness so that the lens design would not be compromised. This option was rejected because the available space for a changing mechanism would be too small. Filters could be put just behind the entrance aperture, but they would have to be 300×360 mm in size. This option was also rejected. The option which was adopted was to put the filters just in front of the camera lens. They would still have to be large, about 241 mm in diameter, and the optical quality would have to be excellent, but the thickness could be variable and the space for a filter changer was available.

A very large telescope with excellent image quality lends itself to direct imaging with narrow-band filters. These, however, must be placed in a nearly parallel beam. Therefore space was provided to allow such filters to be mounted directly behind the entrance aperture in the $f/15$ telescope beam at some future time. Such filters will, of necessity, be much smaller than the total available field and it may be possible to mount up to four such filters in a rotating wheel. The restriction of interference filter sizes is not a serious problem since narrow-band filter photometry on faint objects, which is a suitable operating mode for Keck, does not require a large field of view. This same space in the spectrograph is also being used for a spectropolarimeter (Goodrich et al. 1994).

5. OPTICAL COATINGS

The two mirrors in the spectrograph, the collimator and the mirror for direct imaging on the grating turret, are overcoated silver. They have reflectivities of about 98%. All transmitting optics have efficient multilayer coatings which typically transmit 99% of the light. These include the field lens behind the entrance aperture, all glass-air surfaces in the camera lens, the quartz CCD Dewar window, and the broadband filters. The CaF_2 singlet lens in the camera is coated but the efficiencies of the two coatings are not known.

6. THE CCD DETECTOR

After the spectrograph was designed and being fabricated Tektronix changed the pixel size of their CCDs to 24 μm instead of 27 μm . This means that the detector is slightly smaller than originally planned. As a result the field of view in the y direction is 7.8 arcmin instead of 8 arcmin as originally anticipated. In the other direction the CCD is oversized for direct imaging but is fully utilized in the spectroscopic mode. The somewhat smaller pixel size provides an improvement over the original design since the telescope image

quality and the seeing are better than originally anticipated. The actual scale at the CCD is 4.685 pixels per arcsec.

One of the problems with the thinned Tektronix CCD is that its sensitive surface is slightly curved with a radius of curvature of about 2000 mm (the center of the chip is higher than the edges). The curvature is somewhat different in perpendicular directions and is different for different CCDs. The change of focus over the chip would degrade the image quality significantly. To alleviate the problem the Dewar window has a spherical surface ground onto it to serve as a field flattener. Unfortunately this field-flattening correction is in the same direction as that built into the original Epps lens. Ideally the correction for the CCD curvature should have been incorporated into the original Epps lens design. Fortunately, the additional field flattener degrades the image quality only slightly. The camera design requires that the CCD imaging surface be 10 mm below the rear surface of the Dewar window.

The Dewar for the CCD is made up of two separate parts. The first is a Dewar base which holds the Dewar window, the CCD and its mounting structure supported on thin-walled stainless-steel tubes, some of the electronics on a round PC board, a 55-pin electrical-vacuum connector, and a window heater-wire connector. The other part of the Dewar is the LN_2 container made by Infrared Laboratories, Inc. The CCD is mounted in an aluminum box which holds the CCD firmly and which also encloses the custom-made CCD connector which is a thin frame which plugs onto the CCD pins directly. This box is gold plated and polished. Wires from the CCD to the circular PC board are made of thin constantin wire. A spring and copper strap connect the LN_2 container to the back of the CCD enclosure box to provide cooling. A transistor to monitor the temperature and a heater resistor mounted on the CCD mounting block regulate the CCD temperature to about 0.1 °C. The electronics and the CCD and its mounting block can be electrically isolated from the Dewar. The Dewar has a capacity of 2.5 l and when filled has a hold time of about 40 h. In practice, since the Dewar changes orientation on the telescope it is usually only half full.

7. MECHANICAL DESIGN OF THE SPECTROMETER

LRIS was designed to be mounted in the Keck Telescope standard Cassegrain module. This module is about 1 m long and has a diameter of just over 2 m. In the center of the module is a 2-m diameter circular bearing with a bolt circle which provides for instrument rotation about the optical axis of the telescope.

The LRIS is approximately a rectangular box structure with a length of 2.0 m, a breadth of 1.0 m and a depth of 0.5 m. Two main panels in the plane of the drawing in Fig. 1 are aluminum honeycomb structures with thicknesses of 45 mm. They have an excellent strength-to-weight ratio. The remaining panels on the other sides are 12.5 mm thick welded and machined aluminum plates. A strong rectangular cross-sectional ring made of steel mates with the steel bearing in the Cassegrain module. The roughly rectangular spectrograph body is suspended at the center of the circular ring

using 16 space-frame struts. The struts are located near the corners of the spectrograph and are located so that relative changes in dimensions between the steel ring and the aluminum spectrograph, caused by temperature differences, displace the struts only perpendicular to their lengths thus avoiding any stress on the spectrograph body itself.

Since the LRIS is designed to be mounted at the Cassegrain focus which is enveloped by the mirror cell support structure it is not feasible to have ready access to the instrument during observing. Furthermore the spectrometer is designed to be operated not only from the control room in the dome but also remotely from the Keck headquarters in Kamuela. Therefore all spectrograph functions are motorized and computer controlled.

The Focus Mechanism. As noted in the previous section this mechanism must move the Dewar, the field flattener, and the shutter mechanism, as a single unit. This motion must be strongly constrained so there is no lateral motion of the CCD relative to the image made by the lens. Furthermore, since the lens is very fast, the depth of focus is small and the focus travel must be accurate and reproducible to a few microns. The lateral motion is controlled by mounting the whole unit in four accurate recirculating ball slide mechanisms which have less than 1 μm of play. The focus motion is provided by a stepping motor which drives a preloaded micrometer-type screw. The travel is measured using an absolute encoder which is also driven by the stepping motor. The encoder reads to 1 μm and the repeatability is no worse than a few microns.

The Red Grating Turret and Grating Rotator. The red grating turret is a wheel nearly one meter in diameter which carries five gratings with their individual tilting mechanisms. The turret is rotated by a stepping motor and is locked in one of ten locations by a motor-driven wheel which falls into a large indent on the circumference of the turret itself. Five of the ten positions locate a grating at the appropriate place in the spectrograph beam. The other five locations place the gratings at an access door where the gratings in their cells can be readily changed. Each grating can be tilted by a stepping motor and worm drive. There is also a motor-actuated disk brake to clamp the grating once it is positioned. The grating tilt is measured by a Cannon incremental laser encoder with a zero-point fiducial mark. There is also an LED-photodiode pair to measure the approximate position of the encoder zero point and to provide a fail-safe indication that the grating is safely stowed before the turret can be rotated. The gratings can be set with an accuracy of 4 arcsec.

There are at present three gratings with 300, 600, and 1200 g/mm which provide dispersions, respectively, of 4.99, 2.55, and 1.31 Å per 48 μm (2 pixels on the CCD).

The Slit Mask Changer. The slit masks are made of 0.41-mm thick 6061 aluminum sheets which are mechanically punched to provide slits at any location on the mask. The mask, when inserted in the spectrograph, must be tilted in the x direction to fit the curvature of the telescope plane and also bent in the y direction to provide an adequate fit to the telescope focal plane. The arrangement is shown in Fig. 5. The tilt in the x direction is accomplished by mounting the slit-mask mechanism at approximately an eight degree angle

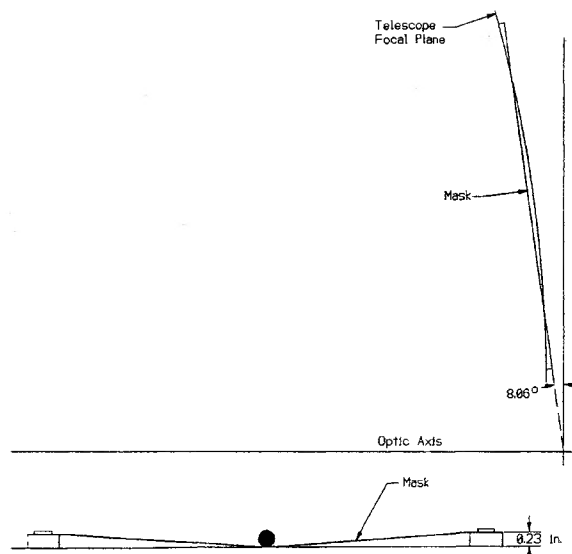

FIG. 5—The location of the slit mask relative to the curved telescope focal plane. The lower part of the figure shows the bending of the slit mask to fit the curved focal plane in the y direction.

to the on-axis focal plane. The bending in the y direction is accomplished by bending the mask into a roof shape by about 6 mm when it is clamped in the slit-mask frame which is about 7 mm thick. This is also shown in Fig. 5.

Since there is no access to the spectrograph when it is on the telescope it is desirable to store and have access to many masks in the spectrograph. This is done by having an enclosed rack attached to the spectrograph which holds ten mask frames. One end of the mask frame has a round hole about 13 mm in diameter. Two round 12 mm diameter keeper rods and a long rod with a 12 mm diameter ball are aligned so that all the slit-mask frames in the box are threaded on the two rods and the ball. The box can be moved back and forth. The ball is located on the end of a long draw rod. When a slit-mask frame is positioned so it has the ball in its circular hole, the rod can be withdrawn, pulling the mask frame out into a long slot in the telescope focal plane. The slit-mask frame is positioned accurately in all directions by spring-loaded rollers and one spring-loaded hard stop. To change masks frames the rod with the captured mask frame is driven back into the carriage box, the box is translated to line up another mask, and the rod is again withdrawn. Masks can be changed in about 1 min and are positioned with an accuracy of 0.05 arcsec.

A few of the slit-mask frames are made so that 5 arcmin long fixed slits with polished jaws can be installed. These are presently adjusted to be 0.5, 1.0, and 1.5 arcsec wide. The slit-viewing guider, described below, looks at the image reflected off these slits. One slit-mask frame must be clear for direct imaging.

Each location in the carriage box is specified by an absolute encoder position. Slit masks can be inserted or removed from the carriage box quickly when the spectrograph is not in the telescope.

The Red Filter Changer. The red filters are located imme-

diately in front of the first optical component of the red camera lens. This mechanism is a copy of the slit-mask changer except that dimensions are somewhat different. Only six filter positions are available and one of these must always be clear.

The Blue Filter Changer, Dichroic Changer, and Blue Grism Changer. These have not yet been built but will probably be copies of the slit-mask changer. The dichroic changer must position the dichroics very precise since for the blue side of the spectrograph the dichroic is a mirror. The grism changer must be very robust since the grisms will be very heavy and thick.

Dust Cover. The whole front of the instrument is encased in a sheet-metal shroud to keep light and dust out of the front of the instrument. The opening in the shroud, which permits light to enter the instrument, has a motorized dust cover which is driven by a stepping motor. The under side of this cover is painted flat white and can be illuminated by a variety of light sources.

Light Sources. Because the field of view is physically very large some care must be taken in illuminating the field or slits in the field. Internal lamps illuminate the under side of the dust cover which is about 12 in. in front of the large entrance aperture. The lamps are mounted, one on each side of the field, to help provide more uniform illumination. Lamps include Hg, Ne, Ar for wavelength calibration of the fixed slits and slit masks, and two quartz halogen lamps for general field illumination.

In the imaging mode flat fields must be obtained through the whole telescope optical train. Two pairs of overhead projectors, mounted on the main support ring of the telescope illuminate a 11-m diameter spot on the inside wall of the dome directly in front of the telescope. The dome wall is painted with aluminum paint and the surface is sufficiently irregular that the return beam into the telescope is quite uniform on a scale of several inches. One pair of projectors provides a high level of intensity while the other pair gives a low light level. During observing, dome flat fields are best obtained by leaving the telescope fixed and rotating the dome so the shutter opening is out of the field.

Guiders. There are two guiders for the spectrograph. These both use Photometrics, Inc. cameras with Thomson 384×288 23- μm pixel frame-transfer CCDs which are thermoelectrically cooled to -40°C . A reimaging system changes the telescope image scale to provide approximately 4 pixels per arcsec.

One camera is used to view the fixed reflecting slits and has a field of 73×93 arcsec. The other camera can be positioned along a 5 arcmin slot at one end of the spectrograph entrance aperture. It has facilities to change focus by nearly 50 mm because of the curvature of the telescope field. The field of view is 64×85 arcsec.

8. CONTROL OF THE SPECTROGRAPH

All the functions described above are computer controlled using a window environment. A cartoon of the spectrograph, illustrated in Fig. 6, shows all the devices in the optical train and the status of the devices. A second window, shown in

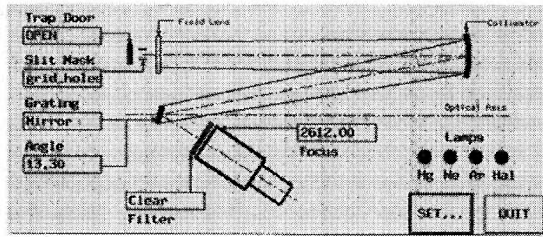

FIG. 6—The window (actually in color) with the LRIS cartoon showing the instrument status.

Fig. 7, provides boxes from which to select parameters or devices. All settings are made by clicking on menus or inserting numbers in small boxes. Exposure time is also controlled with a window as is the storage and archiving of data.

9. PERFORMANCE

Mechanism Speeds. The time it takes to change a filter or slit mask is about 100 s. Changing a grating angle also takes about 60 s and changing a grating and setting its angle takes up to 190 s.

CCD Performance. The CCD has two amplifiers which have clocking rates of $33 \mu\text{s}$ per pixel. It reads out in 70 s. There is a further 20 s required in overhead and storage of the picture onto disk. The picture is displayed as it reads out and is completely visible when the readout is complete. The two amplifiers have readout noise levels of 8.9 and 9.1 electrons, respectively. There is still a minor problem with the CCD readout which will be corrected in the near future. When this correction is made the readout noise should decrease to about 7 electrons. With a nominal gain of approximately 1.9 electrons per data number, the 16-bit digitization does not reach the CCD full well. Therefore, a gain of 3.8 electrons per data number can also be selected. The linearity of the CCD readout is still not well measured but is better than 2%. The CCD is operated at a temperature of -100°C and is regulated to 0.1° ; there is no significant dark current.

Throughput. By observing a standard flux-calibrated star using a wide slit where no loss of light occurs it is possible to measure the throughput of the spectrograph absolutely if the reflectivities of the primary and secondary are known and the atmospheric extinction calculated. The star HZ 4 (Oke 1990)

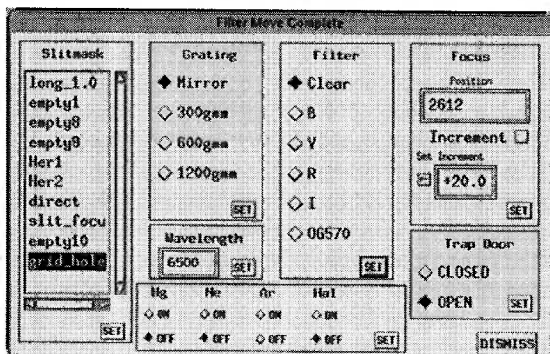

FIG. 7—The window with the various buttons that change the instrument configuration. Numbers are typed into the wavelength and two focus boxes.

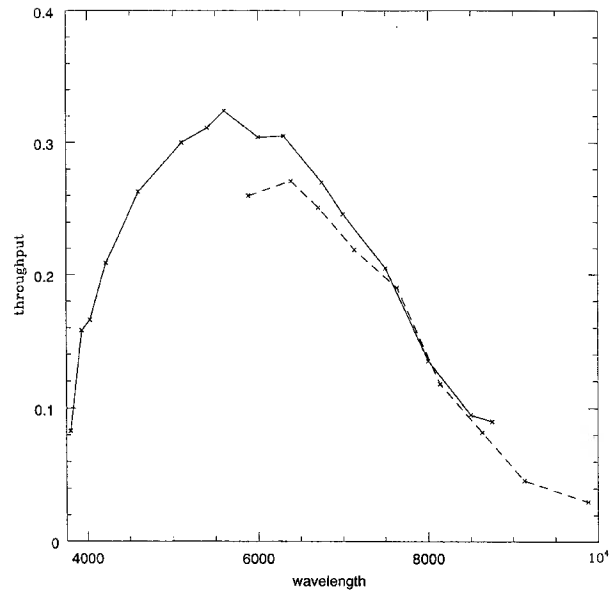

FIG. 8—Throughput of the spectrograph using a 300 g/mm grating. The solid curve was obtained with no order-separating filter while the dashed curve, obtained with a different grating angle, used an OG 570 order-separating filter.

was used as the standard. The area of the Keck telescope, allowing for the central obscuration, is 73.3 square meters. The reflectivities at visual wavelengths of the two telescope mirrors were known quite accurately at the time the measurements were made since they are monitored regularly. They were 0.86 for the primary and 0.88 for the secondary. Reflectivities at other wavelengths were obtained by scaling a standard aluminum reflectivity. A 4 arcsec wide slit was used so there would be essentially no loss of light at the slit. Observations were made with enough grating settings so that the whole spectral range from 3800–10000 \AA was covered. The throughput, defined as the ratio of the number of photons entering the spectrograph slit to the number of photoelectrons detected by the CCD, is shown in Fig. 8 for the 300 g/mm grating. The peak for the 600 g/mm grating is 34% and that for the 1200 g/mm grating is 28%. The efficiency of the spectrograph which reaches a maximum of 0.34 is somewhat lower than the design estimate of 0.38. The difference is probably attributable to the actual grating and coating efficiencies which have not been measured.

In the imaging mode, for a star with $V=15.00$ and $B-V=0.76$ imaged near the zenith, the numbers of photoelectrons detected by the CCD per second for the B , V , R , and I filters are respectively 71600, 160,000, 235,000, and 302,000.

Image Quality. Since the image quality is expected to be excellent it is difficult to produce small enough sources to measure the image quality accurately. In the spectrographic mode comparison spectra made with a narrow slit give the best measures. Comparison linewidths were measured on spectra taken with a 0.5-arcsec slit which, for the 1200 g/mm grating used, projects to 1.80 pixels on the CCD. The full width half maximum (FWHM) was found to be 2.8, 2.2, and

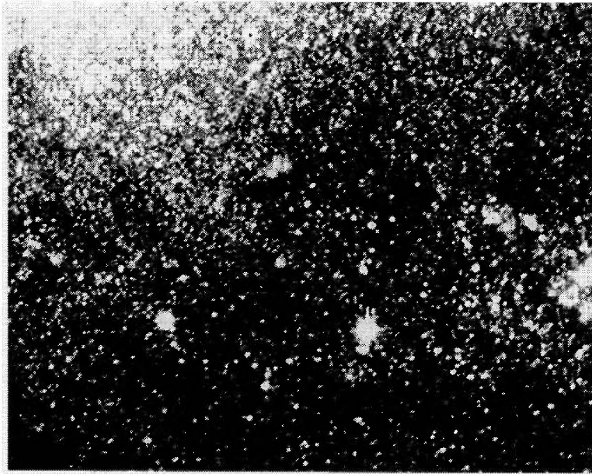

FIG. 9—Part of a 100 s LRIS red image of Messier 33. North is up and east is to the left. The image covers pixels 1048 to 1830 in x and 60 to 690 in y , where the full image goes from $x=228$ to $x=1866$ and $y=0$ to $y=2048$. The picture is to the southwest of the nucleus which is at $x=1107$ and $y=972$. The FWHM is 0.9 arcsec.

2.2 pixels at the left, center, and right edge of the CCD picture. Assuming the broadening functions can be combined as Gaussians, the leads to an instrumental FWHM of 1.5, 1.25, and 1.25 pixels. This is very close to the designed FWHM of the lens which is typically 1.2 pixels. In the direct imaging mode the performance of the spectrograph itself should be comparable with the numbers for the slit mode since there is no evidence that image quality is different in the x and y directions. Actual image quality depends also on the telescope mirror and the seeing. In Fig. 9 is reproduced part of an image of Messier 33. The picture was taken in 1993 July under moderate seeing conditions but while the primary mirror was still being worked on. Star images have a FWHM of 0.9 arcsec. More recently images with FWHM of 0.6 arcsec have been obtained.

Flexure. The goal for the overall flexure of the instrument was $10\ \mu\text{m}$ in the focal plane of the detector from the zenith to an altitude of 30° for any orientation of the spectrometer in its module. The actual flexure figure is about 110 to 140 μm for altitudes of 20° to 90° and for the ideal range in rotational angle of the spectrograph of 180° . There are several contributors to this flexure. First, the spectrograph body contributes about 20 μm of flexure. The red grating turret and the grating rotators each contribute about 40–50 μm . The telescope module in which the spectrograph is mounted bends and distorts the spectrograph producing flexure values up to 60 μm . The telescope module will be replaced sometime in the future. Reducing flexure in the grating turret and grating rotators will require major rebuilding. The flexure is much worse at low altitudes where observations are rarely made.

Flexure can introduce two problems. First, flexure during an exposure can broaden images or blur spectra. To check the effects of flexure changes in position between the start and end of a 60-min exposure, displacements were derived for a large sample of positions all over the sky above an altitude of

20° . In the x direction (along dispersion) the median motion is 0.5 pixels; for 90% of the sample the displacement is 1.2 pixels or less. In the y direction the corresponding numbers are 0.6 and 1.2 pixels. In 90% of 1-hr exposures a spectral line is broadened by only 11% when a 1 arcsec slit is used. This shift is large enough, however, so that a comparison spectrum should be taken at the beginning and end of an exposure if accurate velocities are needed. An alternative is to use night-sky lines for wavelength calibration. Perpendicular to the slit an image is broadened by 0.13 arcsec for 90% of observations. For direct imaging, exposure times of at most 30 min are likely in which case images are broadened by only 0.06 arcsec.

Second, flexure affects flat fielding of images or spectra. If flat fields are taken with the telescope at the same location and the instrument oriented in the same ways as half way through the exposure being flattened, then there should be no problem. On the other hand if flat fields are taken at some average location only, then shifts in x and y between the flat and the unknown frame may be as large as ± 2.5 pixels.

10. THE SLIT-MASK MAKING MACHINE

As noted above, the slit masks are 265 by 340 mm in size. Because of the large scale at the Cassegrain focus individual slits are large enough that a laser slit cutter such as that used at the CFHT (Di Biagio et al. 1990) would be inappropriate. Furthermore, again because of the large scale, machine-tool accuracy is satisfactory and one can use a mechanical slot cutter (Allington-Smith et al. 1994) or a punch. It was decided to use a punching machine. This was designed and built by Schober's Machine and Engineering of Alhambra, California. The machine has a very strong welded structure. The slits are punched with a punch and die which makes a slot 2.8-mm long by approximately 1-mm wide. Longer or wider slits are made by a step and repeat sequence. The punch and die set can be replaced fairly easily to change the slit width or to replace worn components. At present there are two sets which produce slit widths of 0.7 and 1.4 arcsec.

The machine has two orthogonal axes driven by stepping motors and accurate linear encoders. In the short direction of the mask, motion is accomplished by moving the punch and die mechanism. In the other direction the mask is translated in and out. Tests and actual use indicate that the slit positions are accurate to 0.07 mm (0.10 arcsec) over a distance of 140 mm which is the expected range in slit position in the slit-width direction. In the perpendicular direction the range is greater and the error scales accordingly. Some of the slit-position uncertainty is caused by a slight scale factor error; this can be corrected in software. Since the punch is used at an ambient temperature of 20°C and the spectrograph is near 0°C the slit mask changes size by an amount which corresponds to 0.1 arcsec. This can also be corrected in software. The slit width for the present punch and die is accurate to about 3%; this depends on the accuracy of the particular punch and die. The punching is controlled by a personal computer with the slit information provided to the computer as an ASCII table. A mask can be punched in about 10 minutes. The machine is located in the service building of the

Keck telescope on the summit so a rapid turn-around time is possible. It should be recalled that masks cannot be inserted into the spectrograph while it is in the telescope. This means that masks must be prepared a day in advance of observing.

11. SCIENTIFIC PROGRAMS

The LRIS field is such that about 40 objects can be obtained simultaneously with the 300 g/mm grating. With a 158 g/mm grating and a limited wavelength range, one could use two rows of slits and obtain about 80 spectra at one time. Because the field is only 6×8 arcmin, LRIS is best suited to observations of fairly densely distributed objects. With completion of the blue side of the instrument it will be possible to obtain spectra down to 3100 Å.

Projects which will probably be carried out with LRIS include: abundance and kinematic studies of globular clusters around Virgo-cluster and other galaxies; abundances in main-sequence and ascending giant-branch stars in globular clusters; searches for pulsar companions; studies of faint X-ray sources; abundances, dynamics, and evolution in very distant clusters of galaxies; deep redshift surveys; spectropolarimetry of high redshift radio galaxies, AGNs, and quasars; gravitational lens systems; searches for protogalaxies; the $L\alpha$ forest and other absorption lines in very faint high-redshift quasars.

Funds to build the LRIS were provided by the California Association for Research in Astronomy. We wish to thank D. Hilyard and G. Pardeilhans of the Lick Observatory Optical Laboratory who fabricated the glass lens components and did

the coupling of the optical surfaces. We wish to thank the Keck Observatory and particularly Dr. Tom Bida and the staff on the summit for providing generous and extensive help in testing the instrument. We also extend our thanks to Hal Petrie, Brad Butcher, Bill Douglas, Ernest Croner, Gaston Araya, and Caltech's Central Engineering Services for special assistance during the Commissioning phase. J.B.O. wishes to thank the Dominion Astrophysical Observatory for appointing him a Guest Worker and providing research support facilities.

REFERENCES

- Allen, S. L. and Epps, H. W. 1991, BAAS, 23, 1350
 Allington-Smith, J., et al. 1994, PASP, 106, 983
 Di Biagio, B., Le Coarer, E., and Lemaitre, G. 1990, SPIE, 1295, 422
 Epps, H. W., and Peters, P. J. 1973 Proceedings of a symposium held by Institute of Astronomy and Space Science, University of British Columbia, ed. J. W. Glaspey and G. A. Walker, May 1973, p. 415
 Epps, H. W. 1988, Proceedings of the ESO Conference on Very Large Telescopes and Their Instrumentation, ed. M.-H. Ulrich, p. 1157
 Epps, H. W. 1990, Proceedings SPIE, Instrumentation in Astronomy VII, ed. D. L. Crawford (Bellingham, WA, SPIE), Vol. 1235, p. 550
 Goodrich, R. W., Cohen, M. H., and Putney, A. 1994, PASP, 107, 179
 Hamilton, D., et al. 1993, PASP, 105, 1308
 Oke, J. B. 1990, AJ, 99, 1621
 Oke, J. B., and Gunn, J. E. 1982, PASP, 94, 586