

## The ocean–continent transition in the uniform lithospheric stretching model: role of partial melting in the mantle\*

BY J.-P. FOUCHER†, X. LE PICHON‡ AND J.-C. SIBUET†

† Centre Océanologique de Bretagne, B.P. 337, 29273 Brest cédex, France

‡ Université Pierre et Marie Curie, Laboratoire de Géologie dynamique,  
4 place Jussieu, 75230 Paris cédex 5, France

- The role of partial melting in the uniform lithospheric stretching model of continental margin formation is explored. It is shown that the transition from continental lithosphere stretching to oceanic accretion is most probably controlled by the production of a significant amount of partial melting in the asthenosphere immediately below the lithosphere, which requires stretching factors larger than 3. It is also shown that, at stretching factors exceeding 2, the law of subsidence is significantly changed by the presence of partial melt in the underlying asthenosphere. The implications for the existence of deep continental margin basins on thinned continental crusts are examined. The Armorican deep continental margin basin is taken as an example. —

### INTRODUCTION

A simple uniform stretching model of subsidence (McKenzie 1978*a, b*) has been applied at various continental margins (see, for example, Royden & Keen 1980; Royden *et al.* 1980; Cochran 1981; Le Pichon & Sibuet 1981). We use this model to discuss more specifically the nature and mode of transition from the stretched continental lithosphere to the accreted oceanic lithosphere. In particular, we examine whether the stretching model can account for the existence of deep continental margin basins. The Armorican deep continental margin basin is taken as an example.

The method proposed by Le Pichon *et al.* (1982) for the simple stretching model is adopted, which allows us to ignore the density stratification of the lithosphere. This is because, as a first approximation, the lithosphere is floating on top of the asthenosphere, and hence subsidence is controlled by the existence of two reference levels, one near 3.6 km and the other near 7.8 km water depth. These are the levels that would be reached by the asthenosphere in the absence of lithosphere and of formation of oceanic crust. The first one is for hot asthenosphere; the other one for asthenosphere cooled to thermal equilibrium. The instantaneous ( $Z_1$ ) as well as the total subsidence after an infinite time ( $Z_t$ ) can then be expressed simply as a function of the difference of elevation between the starting level and the 3.6 and 7.8 km reference levels, respectively. Thus confining ourselves for simplification to basins below water, we have

$$Z_1 = \gamma(3.6 - E)$$

and

$$Z_t = \gamma(7.8 - E)$$

where  $E$  is the starting water depth,  $\gamma = 1 - 1/\beta$  and  $\beta$  is the stretching factor (see figures 1 and 2).

In the continental margin model discussed by Le Pichon & Sibuet (1981) and Le Pichon *et al.* (1982), the amount of stretching increases from no stretching ( $\beta = 1$ ,  $\gamma = 0$ ) on the continental shelf to a maximum value,  $\beta_{\max}$ , beyond which oceanic lithosphere accretion starts. It was argued by Le Pichon & Sibuet (1981) that, although instantaneous subsidence can theoretically

reach a limit value of 3.6 km for infinite stretching, oceanic accretion will probably start much earlier and will be increasingly likely to occur once the water depth exceeds 2.5 km, which is the level reached by new oceanic crust at mid-ocean ridge crests. However, it was proposed that stretching may occasionally exceed the value corresponding to 2.5 km subsidence, thus producing stretched continental crust that is deeper than the adjacent oceanic crust. As a result, a deep continental margin basin will be created.

The amount of uniform stretching necessary to bring the surface of the lithosphere in isostatic equilibrium from sea level to 2.5 km water depth is 3.2 ( $\gamma = 0.69$ ; see figure 2). It has been shown by Le Pichon & Sibuet (1981) and Le Pichon *et al.* (1982) that such large values of stretching are

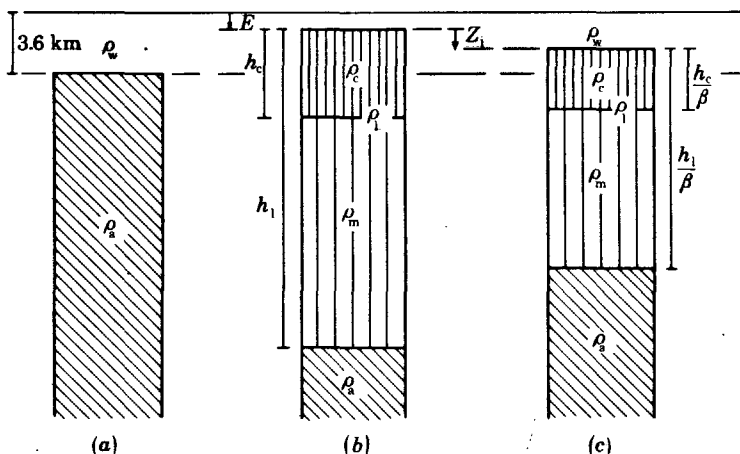

FIGURE 1. Initial stretching phase and isostatic equilibrium. Oblique hatched pattern, asthenosphere; vertical hatched pattern, lithosphere. Average densities are  $\rho_a$  (asthenosphere),  $\rho_m$  (mantle portion of lithosphere),  $\rho_c$  (crust),  $\rho_l$  (whole lithosphere),  $\rho_w$  (water). (a) Hypothetical column with lithosphere entirely replaced by asthenosphere (which is isostatically equivalent with  $\rho_a = \rho_l$ ). This enables definition of the reference levels (mantle geoid and asthenosphere geoid) at 3.6 and 7.8 km respectively. (b) Lithosphere before stretching:  $h_c$  and  $h_1$  are thicknesses of crust and lithosphere respectively.  $E$  is the starting water depth. (c) Lithosphere just after instantaneous stretching by a factor  $\beta$ . The subsidence relative to (b) is  $Z_1$ .

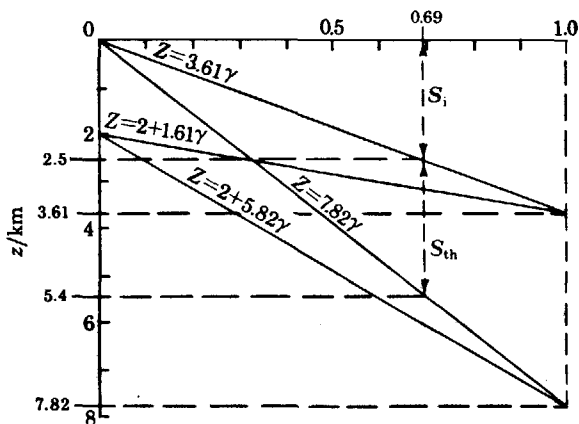

FIGURE 2. Initial instantaneous subsidence and total subsidence as a function of relative thinning of the lithosphere for two different starting elevations: 2 km above sea level and sea-level.  $S_i$  and  $S_{th}$  are the initial and thermal subsidences. The 2.5, 3.61 and 7.82 km levels are identified.

indeed measured on the deeper portion of the Armorican continental margin and that consequently the model could be accepted at least as a first approximation.

The reason why the transition from continental lithosphere stretching to oceanic accretion should occur for a given stretching factor  $\beta$  was, however, not discussed in detail by Le Pichon & Sibuet (1981). They did mention the probable role played by the increase in the amount of partial melting as the base of the lithosphere is raised by stretching but did not try to discuss it quantitatively. That this transition does not occur randomly at widely different stretching factor values is proved by the fact that the transition from stretched continental crust to oceanic crust, where this is documented, does not seem to be marked by a significant topographic step (see, for example, Montadert *et al.* 1971 *a, b*). Thus, it can be concluded that in general the stretched continental crust had reached a level within 500 m or less of the level of emplacement of early oceanic crust when this transition occurred. Such a coincidence is unlikely to be fortuitous and should be controlled by a physical mechanism. Small differences of 500 to 1000 m, when they occur, however, are geologically very significant since they control the existence of early deep continental margin basins. It is consequently necessary to examine the mechanisms that control the transition from the stretching mode to the accreting mode to be able to discuss possible variations at the origin of the basins. In the following, we briefly present the geology and geophysics of the Armorican deep continental margin basin, then we discuss how partial melting may be the mechanism playing the dominant role in provoking the transition from stretching to accretion. We show that taking into account this partial melting introduces significant modifications in the curves of figure 2. We then discuss the possible origin of deep continental margin basins based on this mechanism.

#### THE NORTHERN BAY OF BISCAY CONTINENTAL MARGIN

Over the past 10 years, a considerable number of data have been acquired including those of *Glomar Challenger* Legs 48 and 80. The structure of the northern Bay of Biscay margin is featured by a series of horsts, graben and tilted fault blocks buried beneath a thin sedimentary cover that has been only slightly affected by post-rifting tectonics (Roberts & Montadert 1980). The fault blocks parallel to the margin occupy the area between the shelf edge and the ocean-continent boundary. They affect either the Hercynian basement in the western part of the Celtic margin (Pautot *et al.* 1976) or a pre-existing continental basin as shown by the presence of reflectors within the blocks (Montadert *et al.* 1979 *a, b*) and the results of Hole 401 drilled in a tilted fault block (Montadert *et al.* 1979 *a*). The present structure of the margin is mainly the result of a tensional phase 20–40 Ma long occurring in a submarine environment during Lower Cretaceous time (Montadert *et al.* 1979 *b*; Sibuet & Ryan 1979). Le Pichon & Sibuet (1981) and Le Pichon *et al.* (1982) have shown that extensional values as large as 3 are calculated from the geometry of tilted fault blocks. The calculated amount of thinning for the brittle portion of the crust is comparable with the thinning of the whole continental crust deduced from seismic refraction measurements and required by the uniform stretching model for the whole lithosphere.

A deep margin basin, located on the thinned continental crust, is observed along the northern Bay of Biscay (figure 3) except in the western part of the Celtic margin, where the oceanic crust is directly in contact with the continental slope, a 0.5–1.0 km vertical offset being often observed. From refraction data (Avedik & Howard 1979) and density data from Leg 48, the interpreted profile of figure 3 is shown in figure 4. If the whole sedimentary cover, taken to be in local isostatic

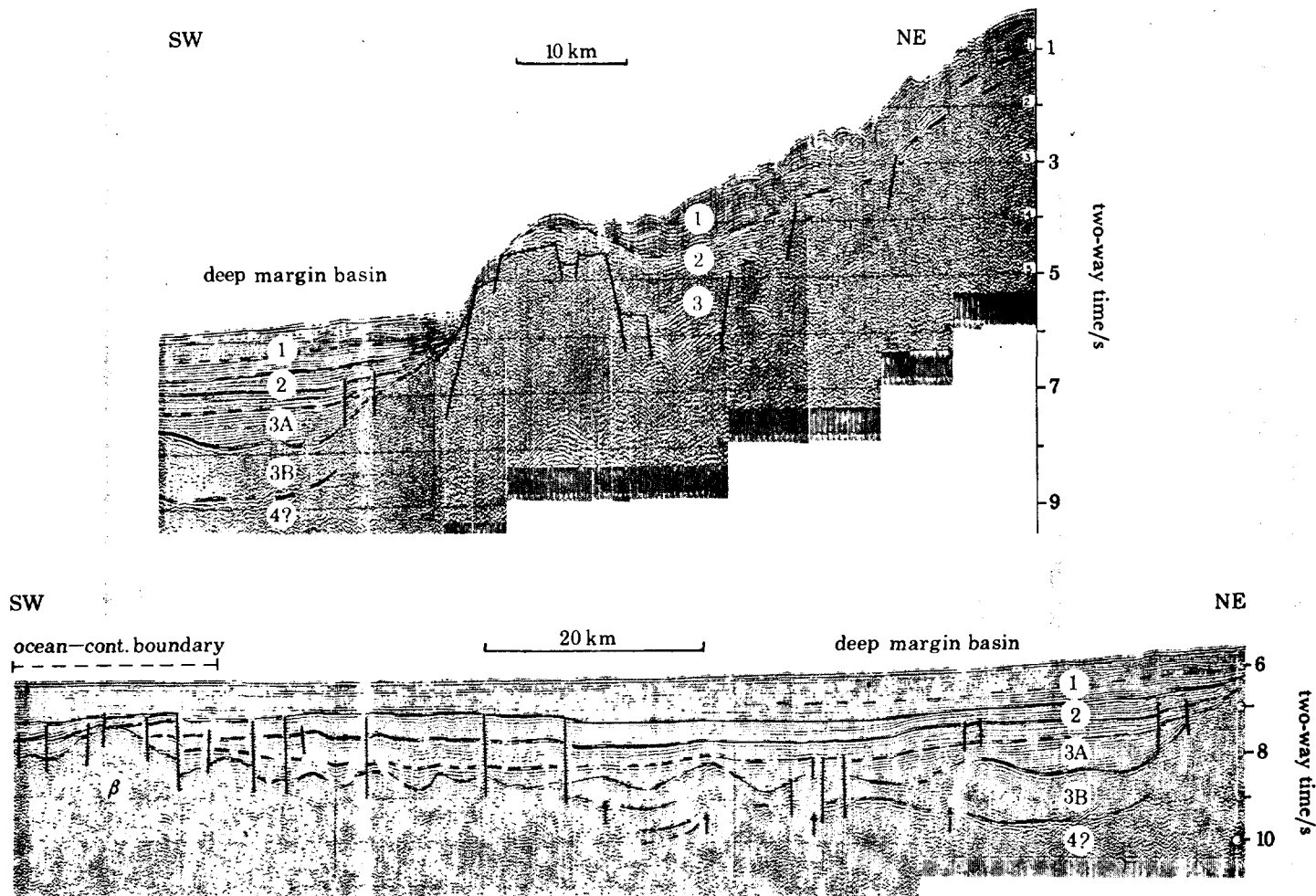

FIGURE 3. C.E.M. 017 seismic reflection section across the Armorican margin (from Montadert *et al.* 1971 *a, b*). The location of the seismic section is shown in the inset to figure 4. Note the rough topography of the reflector at the top of the lower sedimentary unit 3 B.

equilibrium, is removed, a slight deep-margin basin, about 0.5 km deep, remains on the thinned continental crust and is fringed by the oceanic crust or by a small dam generally less than 0.5 km high. Below the deep margin basin, the inferred thickness of the thinned continental crust, based on the interpretation of free-air anomalies in terms of local as well as regional isostatic equilibrium (Lalout 1980), is about 3 km. This value is in agreement with the interpretation of a refraction line shot in the deep margin basin about 50 km southwestwards of the seismic section of figure 3 (Limond *et al.* 1974). In summary, the deep margin basin, located on a greatly thinned continental crust about 3 km thick, is, in the absence of sediments, a slight geological feature 0.5 km or less deeper than the adjacent oceanic crust.

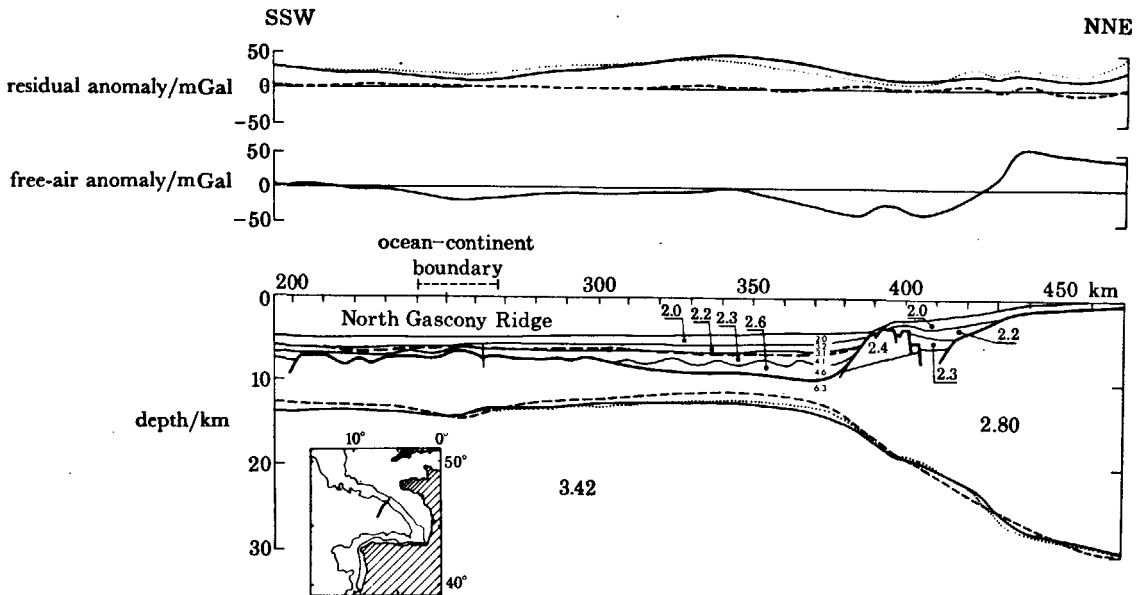

FIGURE 4. Free-air anomaly profile corresponding to the seismic refraction profile of figure 3. Densities in grams per cubic centimetre. Oblique numbers are seismic refraction velocities (Avedik & Howard 1979). The base of the crust is obtained assuming local (solid line) and regional (dotted line, with flexural parameter  $\alpha = 50$  km) isostatic equilibrium. The broken line corresponds to the best-fitting model. The position of the basement after correction for the effect of the sedimentary load is shown by a broken line.

#### PARTIAL MELTING IN THE UPPER MANTLE AT LARGE STRETCHING FACTORS

The base of the lithosphere rises from  $h_1$  to  $h_1/\beta$  during extension by a factor  $\beta$ , which results in the ascent between  $h_1$  and  $h_1/\beta$  of hot upper mantle material at the temperature of the asthenosphere,  $T_a$ , which we take as the temperature at depth  $h_1$  in the mantle (figure 1). At small stretching factors, the pressure drop in the ascending hot upper mantle remains insufficient to produce partial melting, which means that the ascending upper mantle does not cross its solidus. This is not so at large stretching factors when the ascending upper mantle crosses the solidus, then producing partial melting. The critical extension value  $\beta_c$ , beyond which the stretching process produces partial melting as well as the amount of partial melting in the upper mantle at a given stretching factor  $\beta$ ,  $\beta > \beta_c$ , is primarily controlled by the law assumed to describe the dependence of partial melting on temperature and pressure in the upper mantle. Although this law is poorly

known, for discussion purposes we adopt that proposed by Ahern & Turcotte (1979) as it has a simple analytical expression:

$$f = A\{\exp [B(T - Cz - D)] - 1\}, \quad (1)$$

where  $f$  is the degree of partial melting,  $T$  is temperature,  $z$  is depth and  $A, B, C, D$  are constants with values given in table 1. The empirical equation (1) accounts to a fairly good approximation for the experimental data with 0.01 % water reported by Ringwood (1975) (see also fig. 2 in Ahern & Turcotte 1979). Thus, in the following section, we propose to apply the equation of Ahern & Turcotte (1979) to illustrate quantitatively how partial melting in the upper mantle varies as a function of the stretching factor  $\beta$ .

TABLE 1. VALUES OF PARAMETERS

parameter		value
$\rho_w$	density of water	1.0 g cm <sup>-3</sup>
$\rho_s$	density of upper mantle at $T_s$	3.3 g cm <sup>-3</sup>
$G$	adiabatic temperature gradient	0.3 K km <sup>-1</sup>
$A$	constant in (1)	0.4
$B$	constant in (1)	$3.65 \times 10^{-3} \text{ K}^{-1}$
$C$	constant in (1)	$3.0 \times 10^{-5} \text{ K cm}^{-1}$
$D$	constant in (1)	1100 °C
$L$	latent heat of fusion	334 J g <sup>-1</sup>
$C_p$	specific heat	1.05 J g <sup>-1</sup> K <sup>-1</sup>
$\alpha$	thermal expansion coefficient	$3.28 \times 10^{-5} \text{ K}^{-1}$
$\rho_{sl}$	density of melt fraction (liquid basalt)	2.6 g cm <sup>-3</sup>
$\rho_{ss}$	density of melt fraction after solidification	$2.85 + 0.00833z$ ( $z$ in kilometres; see figure 6)

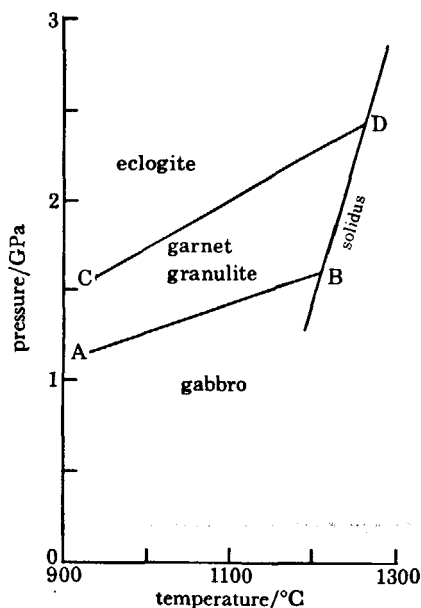

FIGURE 5. Experimental  $P$ - $T$  diagram showing stability fields of eclogite, garnet granulite and gabbro (from Green & Ringwood 1967). The transition from gabbro to eclogite is not sharp but occurs through a 400–800 MPa garnet granulite interval.

Given a stretching factor  $\beta$  and assuming no partial melting ( $\beta < \beta_c$ ), the initial temperature distribution is given by

$$\left. \begin{aligned} T &= (T'_a \beta / h_1) z \quad \text{for } 0 \leq z \leq h_1 / \beta \\ T &= T'_a + G(z - h_1 / \beta) \quad \text{for } h_1 / \beta \leq z \leq h_1, \end{aligned} \right\} \quad (2)$$

and

with  $T'_a = T_a - G(h_1 - h_1 / \beta)$ .

In (2) we have introduced the adiabatic temperature gradient  $G$ , generally ignored in previous developments of the stretching model, but which should be considered in an approach including a description of partial melting effects because of the high sensitivity of the degree of melting to small changes in temperature. This high sensitivity is illustrated by the steep slope of the solidus (figure 5).

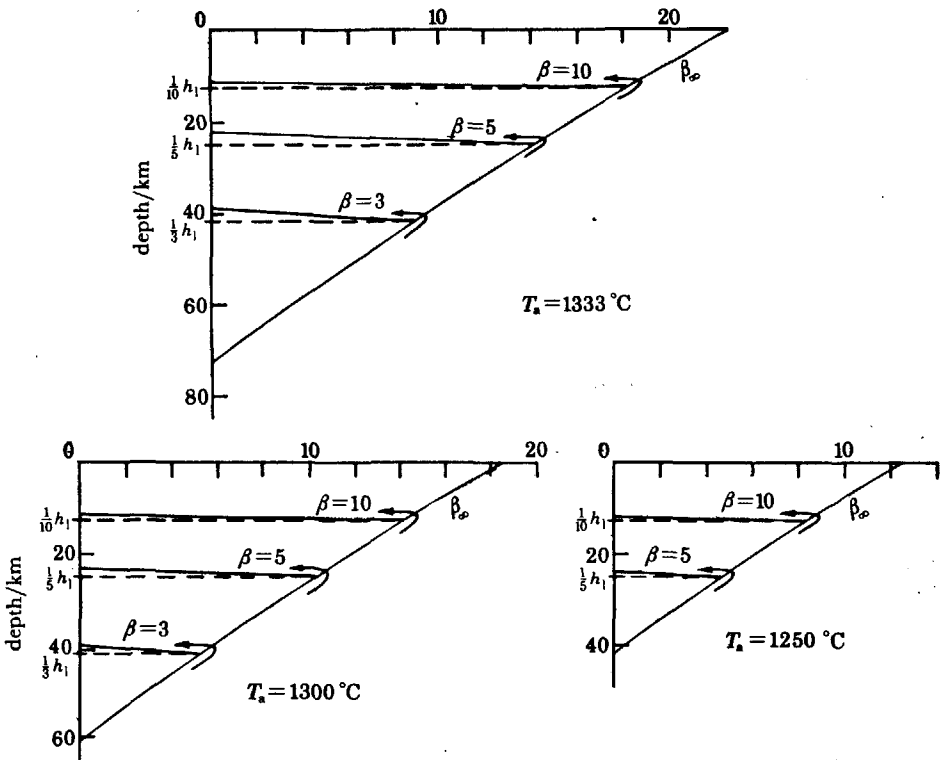

FIGURE 6. Partial melting as a function of depth at various stretching factors (3, 5 and 10) and for three different values of  $T_a$ , 1250, 1300 and 1333 °C.

Introducing now partial melting ( $\beta > \beta_c$ ), equations (2) become

$$\left. \begin{aligned} T &= (T'_a \beta / h_1) z - fL / C_p \quad \text{for } 0 \leq z \leq h_1 / \beta \\ T &= T'_a + G(z - h_1 / \beta) - fl / C_p \quad \text{for } h_1 / \beta \leq z \leq h_1, \end{aligned} \right\} \quad (3)$$

and

where the term  $fL / C_p$  is the temperature decrease due to the extraction of latent heat of fusion,  $L$  is the latent heat of fusion and  $C_p$  is the specific heat capacity at constant pressure (table 1). Thus, the degree of melting,  $f$ , can be calculated from (1) with  $T$  in (1) given by (3). The solution can be obtained from simple numerical calculations. Figure 6 displays the results obtained. Partial

melting is nearly restricted to the upper mantle underlying the stretched lithosphere. The top of the zone of melting is near  $h_1/\beta$ , its base is at depth  $z_f$  obtained from (1), making  $f$  equal to zero.

$$z_f = \frac{T_a - Gh_1 - D}{C - G} \quad \text{for } \beta > \frac{h_1}{z_f}. \quad (4)$$

Through the zone of melting, the degree of melting  $f$  decreases nearly linearly with depth so that to a good approximation the degree of melting  $f$  is given by

$$f = f_0(1 - z/z_f), \quad (5)$$

where  $f_0$  is the degree of melting in upper mantle material ascending adiabatically from the base of the lithosphere to the surface.

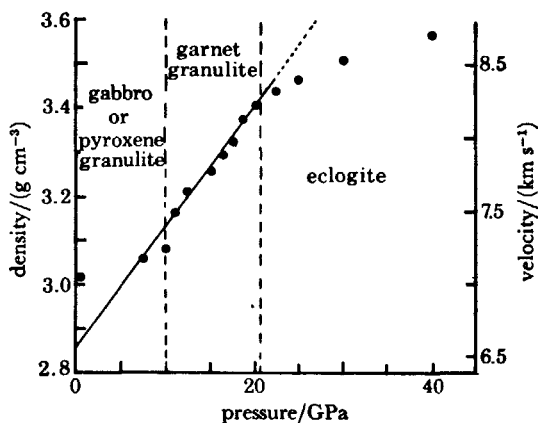

FIGURE 7. Experimental data points reported by Green & Ringwood (1967), showing the increase in density with pressure of alkali basalts. We approximate the density variation with  $\rho = 2.85 + 0.00833z$  (solid line;  $z$  in kilometres,  $\rho$  in grams per cubic centimetre).

Thus, partial melting is predicted to occur as soon as the base of the stretched lithosphere is raised to  $z_f$ , i.e. corresponding to a critical extension value  $\beta_c = h_1/z_f$ .

Taking  $h_1 = 125$  km and  $T_a = 1300^\circ\text{C}$ , then  $z_f = 60.2$  km and  $\beta_c = 2.1$ . For  $T_a = 1333^\circ\text{C}$ ,  $z_f = 72.4$  km and  $\beta_c = 1.7$ . For  $T_a = 1250^\circ\text{C}$ ,  $z_f = 41.7$  km and  $\beta_c = 3$ . It will be noted that partial melting begins at relatively moderate extension values, from 1.7 to 2.1 for usually assumed temperatures at the base of the lithosphere, 1333 and  $1300^\circ\text{C}$  respectively.

Equation (5) is convenient for deriving some quantities of interest to a discussion of the effects of partial melting, in particular the maximum degree of melting,  $f_{\max}$ , which occurs at  $h_1/\beta$ , is given by

$$f_{\max} = f_0(1 - \beta_c/\beta), \quad (6)$$

and the total equivalent thickness,  $h_b$ , of liquid basalt produced is given by

$$h_b = \frac{\rho_a}{\rho_{al}} \int_{h_1/\beta}^{z_f} f_0(1 - z/z_f) dz;$$

$$h_b = \frac{\rho_a}{\rho_{al}} f_0 z_f / 2(1 - \beta_c/\beta)^2. \quad (7)$$

From (6), taking  $T_a = 1333^\circ\text{C}$ ,  $f_{\max}$  reaches 5% at  $\beta = 2.9$ , and 10% at  $\beta = 3.1$ . For  $T_a = 1300^\circ\text{C}$ , the 5 and 10% levels are reached at  $\beta = 2.9$  and 4.6 respectively. For  $T_a = 1250^\circ\text{C}$ ,  $\beta = 5.0$  and 16.0 respectively. Again, the high sensitivity of the results to the assumed temperature  $T_a$  at the



base of the lithosphere is illustrated. However, it must be emphasized that for reasons of continuity in the application of (1) at the transitions from the stretched continental crust to the oceanic crust, the value of  $T_a$  is constrained by the requirement that at  $\beta$  tending to infinity the amount of liquid basalt produced by partial melting is capable of accounting for the creation of a normal 5.5 km thick oceanic crust. From (7), taking  $T_a = 1333^\circ\text{C}$ ,  $h_b = 10.4$  km when  $\beta$  tends to infinity, while for  $T_a = 1300^\circ\text{C}$ ,  $h_b = 7.0$  km, and for  $T_a = 1250^\circ\text{C}$ ,  $h_b = 3.2$  km. Thus, we suggest that realistic descriptions of the partial melting in the upper mantle in the present approach are for values of  $T_a$  between 1333 and  $1300^\circ\text{C}$ , the exact value depending on whether it is considered that nearly all of the liquid basalt produced migrates to the surface to form the oceanic crust, or whether only part of it is involved (Ahern & Turcotte 1979; Sleep 1974).

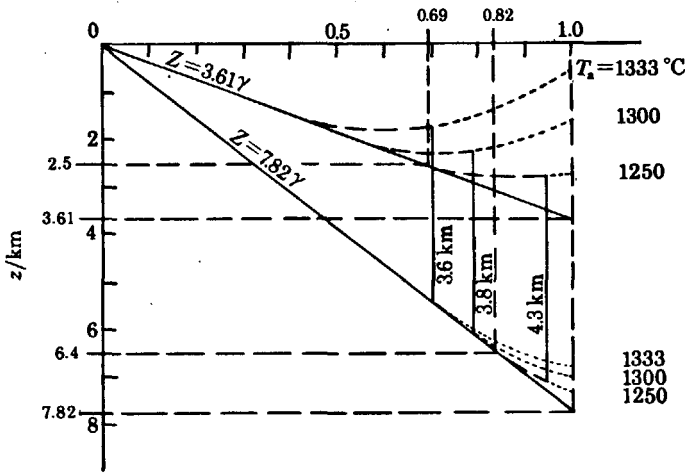

FIGURE 8. Subsidence of figure 2 (solid lines) corrected for the effects of partial melting (broken lines, then dotted lines). Broken lines are for degrees of melting less than 10%. Dotted lines are for degrees of melting exceeding 10%. Vertical bars show the amount of thermal subsidence at  $\beta$  corresponding to a degree of melting of 10%.

Further partial melting introduces significant changes in the mean density of the upper mantle, which result in considerable modifications of the subsidence curves of figure 2. If  $\rho_{a1}$  is the density of the melt fraction (liquid basalt), the mean density change  $\Delta\rho_1$  at  $t = 0$ , introduced over the whole thickness of the melting zone, i.e. from  $h_1/\beta$  to  $z_f$ , is given by

$$\Delta\rho_1 = \frac{\int_{h_1/\beta}^{z_f} \rho_{a1} - \rho_a / \rho_{a1} f dz}{z_f - h_1/\beta} \rho_a, \quad (8)$$

which implies a correction  $\Delta S_1$  ( $\Delta S_1 < 0$  since  $\rho_{a1} < \rho_a$ ) to be applied to the initial subsidence  $S_1$ :

$$\Delta S_1 = \frac{\rho_a}{\rho_a - \rho_w} \frac{\Delta\rho_1}{\rho_a} (z_f - h_1/\beta),$$

or

$$\Delta S_1 = \frac{\rho_a}{\rho_a - \rho_w} \int_{h_1/\beta}^{z_f} \frac{\rho_{a1} - \rho_a}{\rho_{a1}} f dz. \quad (9)$$

In (9) we have assumed that local isostatic conditions prevail at depth  $h_1$ . Similarly, if  $\rho_{a2}$  is the density of the melt fraction after cooling and solidification, a correction  $\Delta S_\infty$  is predicted at

thermal equilibrium, which is given by

$$\Delta S_{\infty} = \frac{\rho_a}{\rho_a - \rho_w} \int_{h/\beta}^{z_f} \frac{\rho_{as} - \rho_a}{\rho_{as}} f dz, \quad (10)$$

where  $\rho_{as} = 2.85 + 0.00833 z$ , taking into account the change in density due to pressure (see figure 7 and table 1).

Figure 8 shows the resulting subsidence curves after corrections have been applied by adopting numerical values in table 1. We have neglected, in the calculation of the corrections above at  $t = 0$ , the effects of the temperature drop  $\Delta T$  due to the extraction of the latent heat of melting,

$$\Delta T = Lf/C_p,$$

which introduces a density change,  $\rho_a \propto \Delta T$ , that is  $\rho_a \propto Lf/C_p$ , about  $0.03 f$ , adopting values in table 1. This density change can be ignored in comparison with the much larger density change  $(\rho_{a1} - \rho_a) \rho_a / \rho_{a1} f$ , about  $0.9 f$ , involved in (8).

#### GENERAL IMPLICATIONS

As is seen from the previous description, and limiting ourselves to the most realistic range of cases of  $T_a = 1333^\circ\text{C}$  and  $T_a = 1300^\circ\text{C}$  within our set of assumptions, partial melting is predicted to occur in the upper mantle beginning at relatively small stretching factors, of the order of 2, then reaching 10% at the base of the stretched lithosphere at  $\beta = 3.1$  for  $T_a = 1333^\circ\text{C}$  or  $\beta = 4.6$  for  $T_a = 1300^\circ\text{C}$ . Thus, a considerable amount of melt is predicted to be present in the upper mantle at moderately large values of  $\beta$ . We suggest that the transition from the stretching process to oceanic accretion is controlled to a large extent by the ability of the large volume of melt produced to migrate and erupt to the sea floor.

Melt migration models have been proposed to account for the segregation of an oceanic crust from a partly molten mantle at mid-oceanic ridges (see, for example, Sleep 1974; Ahern & Turcotte 1979). The first melt produced forms on grain boundary intersections (Waff & Bullau 1979), then with the amount of melt increasing, intersections become interconnected, which makes the matrix more permeable and favours migration due to the buoyancy of the melt fraction. It has been inferred from geochemical studies that migration begins above about 10% melting at mid-oceanic ridges (Kay *et al.* 1970). A 10% melt fraction is produced at extensions from 3.1 ( $T_a = 1330^\circ\text{C}$ ) to 4.6 ( $T_a = 1300^\circ\text{C}$ ), as discussed above. Such extension values may then be minimum estimates required to initiate oceanic accretion. It should be noted from (7) that, with  $\beta$  increasing beyond the critical value  $\beta_c$  at which partial melting begins, the volume of melt produced will increase rapidly, as illustrated by the fact that at  $\beta = 2\beta_c$ , one-quarter of the total volume of melt predicted at  $t_{\infty}$  would be produced. As a result, the probability for the transition from stretching to oceanic accretion process will increase rapidly with  $\beta$ , which suggests that the transition will probably not occur at  $\beta$  greatly in excess of the minimum estimates given above. However, it will be noted that unlike at mid-oceanic ridges the zone of melting in the stretching model does not extend up to the surface but remains confined to the upper mantle underneath the stretched lithosphere. Presumably then, migration will bring the melt material to the base of the lithosphere, where it may accumulate. Large accumulations, however, would be unstable because of the high buoyancy of the melt material. Possible mechanisms for the ascent of the melt material through the thinned lithosphere are propagation along fractures or

elastic cracks, and diapiric intrusion. The melt material could ascend and erupt rapidly to the sea floor once it has reached the base of the lithosphere. It follows that the transition to oceanic accretion would then be primarily controlled by the volume of partial melt produced in the upper mantle and its ability to migrate to the base of the lithosphere. If so, previous estimates of minimum extension values required to initiate oceanic accretion remain valid.

Important implications arise from the modified subsidence curves of figure 8, which permit a discussion of the relative subsidence of the stretched continental crust and the adjacent oceanic crust at large stretching factors, when accounting for the effects of partial melting. As is seen from figure 8, for the values of  $T_a$  between 1300 and 1333 °C that we considered to be realistic, the stretched continental crust is not expected to subside below 2.5 km during extension, which means, if 2.5 km is taken as the depth of the zero age oceanic crust (Parsons & Sclater 1977), that the stretched continental crust remains shallower than the level of emplacement of the oceanic crust. This is because it is assumed that the melted portion does not solidify rapidly as long as it does not erupt to the surface to form the oceanic crust. Its cooling is controlled by the overall cooling of the lithosphere. This seems to remove the possibility that deep continental margin basins may develop on a stretched continental lithosphere deeper than the adjacent oceanic lithosphere in the early stages of oceanic accretion. Assuming that the maximum depth reached by the oceanic crust is 6.4 km (Parsons & Sclater 1977), it is also seen that the stretched continental crust remains shallower than the oceanic crust for  $\beta \lesssim 5$ . Further, the total amount of thermal subsidence can be inferred directly from the curves in figure 8. At the 10 % melt fraction produced at the base of the lithosphere, which we considered as a minimum degree of melting required to initiate oceanic accretion, the total thermal subsidence predicted on the stretched continental crust is 3.6 km assuming that  $T_a = 1330$  °C, and 3.8 km assuming that  $T_a = 1300$  °C. These values would be slightly increased for slightly higher  $\beta$ , but in all cases remain close to the expected thermal subsidence of the oceanic lithosphere, which is about 3.9 km. An important consequence is that no major differential vertical movements at the transition from the stretched continental crust to the oceanic crust are expected to occur during the return to thermal equilibrium after the phase of active extension.

#### EXTENSION OF FINITE VERSUS INSTANTANEOUS DURATION

In the preceding discussion, we have assumed that stretching is instantaneous, i.e. no significant cooling of the stretched lithosphere occurs during the tectonic phase. Jarvis & McKenzie (1980) have shown that this is a reasonable approximation provided the duration of this tectonic phase does not exceed  $60\gamma^2$  Ma for  $\beta \geq 2$ . With large stretching factors, as involved in the deeper parts of the stretched continental crust, and for a duration of extension of the order of megayears as may be realistically assumed, the cooling occurring during the tectonic phase cannot be ignored if topographic differences as small as 500 m are significant to the creation of deep basins.

Let us consider, for example, a phase of active extension  $\Delta t$  Ma long. If the extension were instantaneous, the subsidence after a time  $t$  would be  $S_i$  plus a small portion of the thermal subsidence  $S_{th}$  ( $S_{th} = S_t - S_i$ ), which can be approximated by

$$S_t = S_i + S_{th}(1 - e^{-t/62.8}),$$

assuming an exponential decay and a thermal time constant of 62.8 Ma for the lithosphere (Parsons & Sclater 1977). As the extension is not instantaneous, cooling starts before the end of

the tensional phase. At constant extensional rate, one might approximate the effect by taking a new time  $t' = t + \frac{1}{2}\Delta t$  for computing  $S_{th}$ . As the stretching factor actually changes continuously from 1 to a maximum value, the effect will be about one-half and an order of magnitude estimate can be obtained by choosing  $t' = t + \frac{1}{4}\Delta t$ . This was checked by numerical computations by Angelier *et al.* (1982) for the Aegean sea, where  $\Delta t = 13$  Ma and  $\beta = 1.5$  to 2.

As a consequence, the actual curves computed in the preceding section for instantaneous stretching should be corrected at  $t = 0$  by adding a term  $\Delta S$  of the order of

$$S_{th}(1 - e^{-\Delta t/4 \times 62.8}).$$

With  $\Delta t = 20$  Ma,  $S_{th} = 3900$  m and  $\Delta S = 300$  m; with  $\Delta t = 40$  Ma,  $\Delta S = 600$  m.

Thus the subsidence curves as a function of  $\gamma$  now reach a level deeper than the level of emplacement of new oceanic crust because the stretched lithosphere has already begun to cool when the oceanic lithosphere is emplaced. Such an effect is thus necessarily implied if the stretching is not instantaneous. Simultaneously, another mechanism, the transfer of heat by lateral conduction, also generates a relative cooling at the base of the continental slope with respect to the seaward stretched continental crust and results in the creation of a depression (Watremez 1980).

Note, on the other hand, that the effect on the amount of melting produced will be much smaller and can probably be neglected. This is because cooling by conduction from the surface is unable to penetrate deep to the lower boundary of the lithosphere, below which most of the melting occurs. Consequently, if the transition to accretion is controlled by the amount of partial melting, it will occur at the same value of  $\beta$  but for a larger subsidence; thus a basin can be created. This difference of level will disappear progressively with time as cooling proceeds, but the basin may be preserved if it has been loaded with sediments.

#### APPLICATION: THE ORIGIN OF THE DEEP ARMORICAN BASIN

As seen previously, if our density estimates are correct, a slight unloaded basin 0.5 km deep exists on the greatly thinned continental crust of the deep Armorican margin. The boundary of the basin is marked by a little basement offset 0.5 km high in the vicinity of the ocean-continent transition. The uniform stretching model, including the effects of partial melting, accounts for the formation of an early basin if we include the effect of an extensional phase about 40 Ma long. However, this model does not explain that, at infinite time and after isostatic correction, the basement depth appears to be larger than that of the oceanic crust.

At this point, it should be noted that the law of partial melting in the mantle is poorly known and that, in any case, it is extremely sensitive to variations in temperature. Thus, one could obtain rather different results with relatively slight changes in the physical parameters. Further, we have not taken into account the compressibility of the melted portion. Stolper *et al.* (1981) argue that because the compressibility of basaltic melt is much higher than that of mantle minerals, the density contrast between melt and the solid phase should decrease with increasing source region depth. This effect would tend to increase the likeliness of formation of deep early basins on thinned continental crust.

On the other hand, if the igneous crust is indeed only 3 km thick, this model cannot account for such a large extension factor ( $\beta = 10$ ). A possible explanation, compatible with the stretching

model, could then be that the Neocomian phase of extension affected a pre-existing basin (the double rifting phase model).

Montadert *et al.* (1979 *a, b*) have clearly shown the existence of such a pre-existing basin on the Celtic margin northwest of the Meriadzek Terrace, for example, at Site 401 (Montadert *et al.* 1979 *a*), which was drilled in 2500 m water depth through a tilted fault block, where the existence of a shallow water Jurassic carbonate platform is suggested. On the other hand, several authors (e.g. Winnock 1971; Dardell & Rosset 1971; Mattauer & Séguret 1971; Olivet 1978) have proposed that the Permian to Lias tensional phase led to the formation of a depression partly filled with Jurassic sediments along the present day Northern Bay of Biscay margin. Without entering into a debate about the nature and origin of the lowest sedimentary layer identified as 3 B on figure 3 and in which velocities of  $4.4 \text{ km s}^{-1}$  (Bacon *et al.* 1969) and  $4.6 \text{ km s}^{-1}$  (Avedik & Howard 1979) have been found, we suggest that, at the level of the Armorican margin, this layer 3 B could correspond to the infilling of a pre-existing depression that has been stretched during the Neocomian phase. If the thickness of the continental crust is reduced to 3 km beneath the deep Armorican Basin, an explanation could be that this portion of the crust has been stretched twice by a global stretching factor reaching 10. In that case, if the interval between the two phases of extension is long enough to cool the lithosphere sufficiently, the base of layer 3 B after the second tensional episode should be at a depth greater than that of the new oceanic crust emplaced at 2.5 km deep, more or less at the level of the top of the stretched sediments. The resulting basin would consequently be created at the end of the second tensional phase, the newly emplaced oceanic crust acting as a dam for already emplaced sediments.

### CONCLUSION

Adopting the simple analytical expression proposed by Ahern & Turcotte (1979) for the degree of partial melting in the mantle as a function of temperature and depth, we have determined the amount of partial fusion produced in the formation of a continental margin by using the uniform lithospheric model. Although the law is poorly known and is highly sensitive to slight changes in the physical parameters, our study demonstrates the importance of this phenomenon and indicates that the transition from stretching to accretion most probably occurs once the amount of melt produced in the asthenosphere below the stretched lithosphere becomes large enough.

Using an adiabatic temperature of  $1262.5^\circ\text{C}$  (actual temperature  $1300^\circ\text{C}$ ) and  $1295.5^\circ\text{C}$  (actual temperature  $1333^\circ\text{C}$ ) at the base of the 125 km thick lithosphere before thinning, we have derived the corrected curves of subsidence. As long as the melt does not migrate to the surface to form the oceanic crust, it will cool very slowly within the lithosphere and consequently will take several tens of megayears to solidify completely. Thus, the difference of density between liquid and solid phases leads to a smaller subsidence, the difference in the initial subsidence being several hundred metres, depending on the actual amount of stretching reached. Melting begins at a stretching factor of about 2 and becomes significant (maximum of 10 %) at a stretching factor of 3–4. Thus it is at this large stretching factor that the transition to oceanic crust becomes possible.

A significant feature of the new curves of subsidence is that the thinned continental lithosphere, in the initial subsidence stage, is always shallower than new oceanic lithosphere. However, as the process of extension is not instantaneous but takes several tens of megayears, cooling has already

affected the thinned continental lithosphere when accretion starts. As a result, the depth reached may be larger than the depth of the mid-ocean ridge and a deep continental margin basin may thus exist in the initial stage of sea-floor accretion. However, the difference of elevation should progressively disappear with age, although sedimentary loading will maintain the depressed basement.

Although this study was initiated to explain the presence of the deep Armorican continental margin basin, the process just described does not seem to be able to explain it. This is because the crust of the basin appears to be extremely thin according to gravity estimates (3 km, requiring  $\beta = 10$ ). Such a large thinning, if it is confirmed, may perhaps be explained within the framework of this model by a double-rifting stage.

N. Guillo-Uchard and A. Grotte helped with the preparation of the paper and illustrations.

#### REFERENCES (Foucher *et al.*)

- Ahern, J. L. & Turcotte, D. L. 1979 *Earth planet. Sci. Lett.* **45**, 115–122.
- Angelier, J., Lyberis, N., Le Pichon, X., Barrier, E. & Huchon, P. 1982 *Tectonophysics* (In the press.)
- Avedik, F. & Howard, D. 1979 *Init. Rep. D.S.D.P.* **48**, 1015–1024.
- Bacon, M., Gray, F. & Matthews, D. H. 1969 *Earth planet. Sci. Lett.* **6**, 377–385.
- Cochran, J. R. 1981 *J. geophys. Res.* **86**, 263–287.
- Dardell, R. A. & Rosset, R. 1971 In *Histoire structurale du Golfe de Gascogne* (ed. J. Debyser, X. Le Pichon & L. Montadert), vol. 4, pt 2, pp. 1–28. Paris: Éditions Technip.
- Green, D. H. & Ringwood, A. E. 1967 *Contr. Miner. Petr.* **15**, 103–190.
- Jarvis, J. G. & McKenzie, D. P. 1980 *Earth planet. Sci. Lett.* **48**, 42–52.
- Kay, R., Hubbard, N. & Gast, P. 1970 *J. geophys. Res.* **75**, 1585–1613.
- Lalaut, P. 1980 Thèse de 3ème cycle, Université Pierre et Marie Curie, Paris (131 pages.)
- Le Pichon, X. & Sibuet, J.-C. 1981 *J. geophys. Res.* **86**, 3708–3720.
- Le Pichon, X., Sibuet, J.-C. & Angelier, J. 1982 In *A.A.P.G. Proceedings of the Hedberg Conference, Galveston, January 1981*. (In the press.)
- Limond, W. Q., Gray, F., Grau, G., Fail, J. P., Montadert, L. & Patriat, P. 1974 *Earth planet. Sci. Lett.* **23**, 357–368.
- McKenzie, D. 1978a *Earth planet. Sci. Lett.* **40**, 25–32.
- McKenzie, D. 1978b *Geophys. J. R. astr. Soc.* **55**, 217–254.
- Mattauer, M. & Séguet, M. 1971 In *Histoire structurale du Golfe de Gascogne* (ed. J. Debyser, X. Le Pichon & L. Montadert), vol. 4, pt 4, pp. 1–24. Paris: Éditions Technip.
- Montadert, L., Damotte, B., Delteil, J. R., Valéry, P. & Winnock, E. 1971a In *Histoire structurale du Golfe de Gascogne* (ed. J. Debyser, X. Le Pichon & L. Montadert), vol. 3, pt 2, pp. 1–22. Paris: Éditions Technip.
- Montadert, L., Damotte, B., Fail, J. P., Delteil, J. R. & Valéry, P. 1971b In *Histoire structural du Golfe de Gascogne* (ed. J. Debyser, X. Le Pichon & L. Montadert), vol. 6, pt 14, pp. 1–42. Paris: Éditions Technip.
- Montadert, L., Roberts, D. G., de Charpal, O. & Guennoc, P. 1979a *Init. Rep. D.S.D.P.* **48**, 1025–1060.
- Montadert, L., de Charpal, O., Roberts, D. G., Guennoc, P. & Sibuet, J.-C. 1979b In *Deep-drilling results in the Atlantic Ocean: continental margins and paleoenvironment* (ed. M. Talwani, W. W. Hay & W. B. F. Ryan) (Maurice Ewing series, vol. 3), pp. 164–186. Washington, D. C.: American Geophysical Union.
- Olivet, J. L. 1978 Thèse de Doctorat d'État, Université de Paris 7. (200 pages.)
- Parsons, B. G. & Sclater, J. G. 1977 *J. geophys. Res.* **82**, 803–827.
- Pautot, G., Renard, V., de Charpal, O., Auffret, G. A. & Pastouret, L. 1976 *Nature, Lond.* **263**, 669–672.
- Ringwood, A. E. 1975 *Composition and petrology of the Earth's mantle*. McGraw-Hill. (618 pages.)
- Roberts, D. G. & Montadert, L. 1980c *Phil. Trans. R. Soc. Lond. A* **294**, 97–103.
- Royden, L. & Keen, C. E. 1980 *Earth planet. Sci. Lett.* **51**, 343–361.
- Royden, L., Sclater, J. G. & von Herzen, R. P. 1980 *Bull. Am. Ass. Petrol. Geol.* **64**, 173–187.
- Sibuet, J.-C. & Ryan, W. B. F. 1979 *Init. Rep. D.S.D.P.* **47 B**, 761–775.
- Sleep, N. H. 1974 *Bull. geol. Soc. Am.* **85**, 1225–1232.
- Stolper, E., Walker, D., Hager, B. H. & Hays, J. F. 1981 *J. geophys. Res.* **86**, 6261–6271.
- Waff, H. S. & Bulau, J. R. 1979 *J. geophys. Res.* **84**, 6109–6114.
- Watremez, P. 1980 Thèse de 3ème cycle, Université de Bretagne Occidentale. (108 pages.)
- Winnock, E. 1971 In *Histoire structurale du Golfe de Gascogne* (ed. J. Debyser, X. Le Pichon & L. Montadert), vol. 4, pt 1, pp. 1–30. Paris: Éditions Technip.

### Discussion

D. G. ROBERTS. It is difficult to estimate the amount of extension in an area. To carry out this type of investigation you need migrated seismic sections with very good control on the interval velocities, as well as refraction control. To estimate the extension we have concentrated on those blocks where we can see the basement reflexion. The values of the extension ( $\beta$ ) that we obtain vary from about 1.1 to 1.45. The block to the west of the one that Foucher showed has extended by 1.45, and the basement reflexion is clear. But it is by no means straightforward to interpret the section, and the value obtained for the extension depends on your assumptions about the geometry of the faulting.

J.-P. FOUCHER. Why I explained in some detail how we obtained our estimates of the extension was to answer some of the points that Roberts has raised. The estimates in question were all obtained from the interpreted seismic section of Montadert *et al.* They are the measured ratios between the present total length of the profile and the lengths of different layers. Where the geometry is ambiguous we have used the minimum amount of extension.

P.-Y. CHÉNET. Dr Foucher has remarked that the estimate of the amount of extension obtained from the shallow brittle deformation differs from that at depth. In the Meriadzek-Trevelyan region it is about 1.5 near the surface and increases to 2 at a depth of 6–8 km. I have obtained the same values for the same blocks, which is encouraging. But Dr Foucher said that this difference should be produced by greater brittle deformation at the shallow levels. This would mean a thinning of the upper layers by about 30 % by brittle failure, and none at depth. I have never seen an outcrop that shows 30 % thinning produced by internal deformation. I think a more reasonable model is one in which the extension throughout is about 1.5, which is taken up by brittle failure at shallow depths and by creep at deeper levels. The creep may cause lateral offsets in deep layers and therefore may be responsible for the difference between the extension determined from the geometry of shallow and deep layers respectively.

A. W. BALLY. I should like to comment on the cross section showing layers marked A to D. Judging from the slide, it looks as if the cross section is not balanced, since the length of layer A appears to be much longer than that of layer D. Balanced cross sections have served as useful approximations in the reconstruction of folded belts. The same method can be used on sections displaying normal faulting. Thus you can only speculate that layer A has been thinned. Such thinning would prevent you from making an accurate estimate of the extension, if you do not know what the original thickness of the layer was.

J.-P. FOUCHER. As I said, if you wish to balance the cross section you have to allow layer A to have been thinned by internal deformation. I agree that this introduces some difficulty in measuring the extension from the geometry of the uppermost strata, which we assume in our interpretation to have been disturbed.

A. W. BALLY. But then the reasoning may be circular. First you draw a cross section that is not balanced, then you conclude that because the section is not balanced, stretching must occur. However, you cannot show which layers have been thinned during the extension and which other layers have not. Also, there is no way that such thinning can be detected on the reflexion section only.

**J.-P. FOUCHER.** It seems to us reasonable to assume that the uppermost layers could deform during the gliding of the blocks to their present position, especially if these layers were poorly consolidated, as seems likely. The available seismic data do not permit the detection of such small-scale deformation, though field observations support this interpretation. Clearly, when measuring extension, care should be taken to measure it over the whole thickness of the brittle layer, and not just over the uppermost layer, which is often disturbed.

**E. R. OXBURGH, F.R.S.** It is only possible to carry out the type of reconstruction shown in both of the previous papers if the sections are obtained normal to the strike of the faults. There has recently been considerable debate on how the Bay of Biscay opened, and it is not yet generally agreed in what direction the relative motion occurred. I would therefore like to ask the authors of both papers how well they can constrain the strikes and the dips of the faults in the region? If these constraints are not good, then the types of calculations that they have described may only put rather broad limits on the amount of extension.

**D. G. ROBERTS.** There is a very great deal of seismic data available in the area, and as far as possible the lines have been run normal to the faults separating the blocks. We believe that a more important source of error is the absence of accurate seismic velocities. It is not possible to estimate the extension until the diffractions have been removed and the time section converted into a depth section by using the interval velocities. Since the dip of both the faults and the blocks is controlled by the velocities used in this conversion, the extension estimates are dependent on accurate velocities.

**SIR PETER KENT, F.R.S.** One of the maps shows a considerable amount of dip faulting, as well as strike faulting, which presumably makes extension estimates even harder to obtain.

**D. G. ROBERTS.** On the floor of the Bay of Biscay and close to the ocean junction between the ocean and the continent there are a number of inversion structures related to the late stages of the Pyrenean orogeny in the Eocene and Oligocene. One of the sections clearly shows such an inversion on the ocean side of the continental ocean boundary. In making estimates of the extension we have tried to avoid such places and have concentrated on those areas dominated by listric normal faults. For this reason we chose to carry out the experiment west of the Trevelyan Escarpment because of the clear evidence of inversion there in the Eocene and Oligocene.

**P.-Y. CHÉNET.** I believe that it is important to test whether a simple stretching model, with the same extension at all depths, can produce the main features of this continental margin. I do not believe that it can account for the observed geometry of the listric normal faults, and think that we need a model with at least two layers, each of which undergoes different amounts of extension.

**J. F. DEWEY.** I do not believe that it is possible to use the geometry of the listric faults alone to make accurate estimates of the amount of extension. Where such features have been studied in the field, there is clear evidence for a considerable amount of internal deformation within the blocks on either side of the faults, by movement on joint planes, faults, fissures and other processes, none of which would be visible on a seismic record, and all of which would contribute to the strain.

**D. G. ROBERTS.** I agree that such processes would not be visible on a seismic section, which can only resolve the large structures. But none the less the estimates of extension that we have obtained are considerably smaller than those obtained by Le Pichon and Sibuet using the same seismic lines. In any case our values are maximum ones.



**J. F. DEWEY.** But I do not believe that it is possible to use the geometry of the brittle faulting of the upper part of the crust to make accurate estimates of the extension. All that such studies can provide is a lower limit on the amount of extension. A better way to estimate the extension is to use the change in crustal thickness, which avoids the problems caused by internal deformation of the sediments.

**M. H. P. BOTT, F.R.S.** It is only possible to stretch the upper crust by jointing by about 5 % before the density becomes too low to be compatible with the gravity observations. But this is far from the 100 % required to make the geometric deformation compatible with the crustal thinning.

**J. F. DEWEY.** But this argument does not apply if the holes are filled with carbonate or some other cement!

**J. A. JACKSON.** Another type of observation that is relevant to Dewey's suggestion is the observed strain release following large normal faulting earthquakes. Though many small aftershocks occur within the blocks on either side of the main fault plane, the displacements involved in these shocks are small compared with that on the main fault plane. These observations suggest that the internal deformation occurs because of the geometry of the main fault.

If the dip of the main fault changes with depth, motion can only occur if the blocks on one or other side deform internally. But there is no seismic evidence that this internal deformation makes an important contribution to the total strain.

**M. F. OSMASTON.** The lithosphere-stretching hypothesis, discussed in both the preceding papers to account for the observed faulting, has the essential property that the duration of lithosphere stretching at depth must exactly match the period or periods of apparently extensional surface faulting. If the latter were to occur without the former, even for a short time, décollement of fault slices would be implied and this would put in question whether *any* of the faulting is a measure of lithosphere stretching. A duration of stretching from the Triassic until some time in the Cretaceous seems plate-tectonically unlikely; so too would be a continuance of stretching after the locus of ocean floor genesis had moved away from the margin. Therefore, how precisely at present can one define the period or periods of apparent extensional faulting and how does the date of its final cessation compare with independent evidence of the age of the ocean floor at this margin?

**D. L. TURCOTTE.** There are two other mechanisms of thinning crust that have received rather little attention today. The first is uplift followed by erosion. There is no doubt that this process has recently occurred along the East African rift system, where there is also evidence of crustal thinning. Presumably this region will later subside to form a basin. The other possibility is that phase changes occur in the lower crust. It is important that these alternatives to the crustal stretching model should continue to be discussed.