

THE POWER LINE TRANSMISSION CHARACTERISTICS FOR AN OFDM SIGNAL

A. Mori, Y. Watanabe, and M. Tokuda

Musashi Institute of Technology
1-28-1 Tamazutsumi, Setagaya-Ku, Tokyo, Japan 158-8557

Sumitomo Electric Industries, LTD.
Information & Communication Laboratories
1-1-3, Shimaya, Konohana-ku, Osaka, 554-0024 Japan

Abstract—In this paper, we measured what influence the sinusoidal transmission characteristics of the electric power line with various forms gave to the transmission characteristic of OFDM (Orthogonal Frequency Division Multiplexing) signal through PLC (power line communication system) modem. The electric power line transmission line with various forms in a real environment is classified into two basic elements, which are an outlet type branch and a switch type branch. Next, PHY rate (Physical rate) is measured for each basic element connected with the PLC modem. At this time, the transmission characteristics of the electric power line are simulated from measured data. OFDM sending and receiving systems are composed on the computer, and the PHY rate is simulated. By comparing with measured and calculated values, it is revealed that PHY rate of PLC modem is most affected in the case of the power line transmission characteristics having broad band and high level attenuation and is not affected in the case of that having narrow band group delay variation.

1. INTRODUCTION

Recently, Internet users are increasing by the rapid spread of the Internet and the Internet user needs the broadband that are high-rates and inexpensive communication service. While the access networks such as FTTH (Fiber To The Home) and xDSL (Digital Subscriber Line) spread, PLC attracts attention as the Internet connectivity from each room, and a home network, which controls household-electric-appliances. In PLC, since a communication network can be realized

by using the existing power line, it is not necessary to install a transmission cable in addition, and a convenience outlet serves as a connection port of network at a general home, and office and factory. Moreover, since network connection and an electric power supply can be made together, we can use PLC like Wireless LAN [1–3].

However, power lines differ from telephone lines in that they are bus-type wiring and a great variety of device are connected to them. Thus, the impedance, transmission line loss and noise level of power line fluctuate greatly according to how the devices are connected and their operating conditions. To realize stable high-speed communication even under such circumstances requires the use of technology that is employed in wireless communication, such as OFDM [4, 5]. In OFDM method, it is excellent in the efficiency of the frequency use, because a lot of sub-carriers are orthogonal in the frequency domain. Therefore, a lot of sub-carriers can be used, and it is possible to follow to the transmission line characteristic flexibly. Moreover, in the OFDM method, when the electromagnetic wave from PLC influences other existing systems, it is possible not to use the carrier frequency of this band or it can be set to lower the sending level. From such a feature, the adoption of the OFDM method is a mainstream in the PLC modem [4–6].

In such a background, a real environmental test with PLC modem using the OFDM method is progressed. And, there is a report concerning the electromagnetic compatibility technology [6–9]. There are various examinations for the electromagnetic radiation characteristic and quantification method [9–12]. On the contrary, as one of the concerns for which the user uses PLC, the communication should be high-quality and be seamless in wiring in the home. If maximum 200 Mbps is achieved in the PLC modem under development without trouble, it is possible to adjust to a large data transfer of the personal computer peripherals in recent years. When paying attention to such a viewpoint, there are a lot of uncertain parts what influence the characteristic of a complex electric power line gives to the OFDM signal. In the past, the influence of the transmission characteristic of the electric power line has been verified by real environmental experiment. Therefore, the example of the quantitative examination is few.

In this paper, in such a background, we first measured the transmission characteristic of the electric power line with branch [11]. The electric power line transmission line with various forms in a real environment is classified into two basic elements, which are an outlet type branch and a switch type branch. Next, PHY rate (Physical rate) is measured for each basic element connected with the PLC modem.

OFDM sending and receiving systems are composed on the computer, and the PHY rate is simulated. By comparing with measured and calculated values, we try to make clear what influence the sinusoidal transmission characteristics of the electric power line with branch gave to the transmission characteristic of OFDM (Orthogonal Frequency Division Multiplexing) signal through PLC modem.

2. MEASUREMENT OF ELECTRIC POWER LINE TRANSMISSION CHARACTERISTIC TO SINUSOIDAL WAVE SIGNAL

2.1. Basic Elements of Power Line Transmission Model

When measuring the transmission characteristic of the power line with PLC modem, it is necessary to use shield room. However, since we have only G-TEM (Giga-hertz Transverse Electro-Magnetic) Cell, we composed the concise electric power line transmission line model as shown in Figure 1. The VVF (Vinyl insulated and Vinyl sheathed Flat type) cable with a conductor diameter of 1.6 mm is used for the power line. The electric power line transmission line with various forms in a real environment is classified into basic elements as shown in Figure 1, which are important elements influencing the power line transmission characteristics.

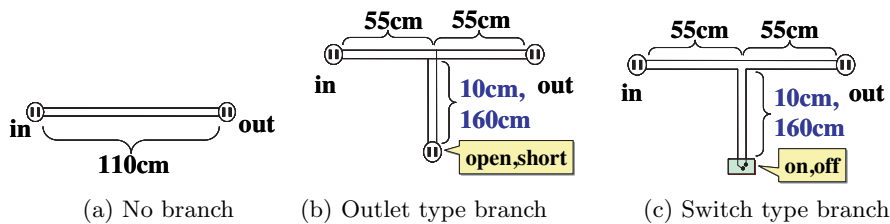

Figure 1. Power line transmission model.

- (a) No branch: The total length is 110 cm.
- (b) An outlet type branch: The main cable length is 110 cm. The branch cable with length of 10 cm or 160 cm is branched at the middle point of the main cable (55 cm). The terminal form of the branch cable is open or short.
- (c) A switch type branch that is used in a power line for lamp: Cable configuration is almost the same as the outlet type branch, but the branch cable is connected only one line of main cable. Terminal condition of branch cable is on or off.

2.2. Measurement of Transmission Loss Characteristics

Figure 2 shows the measurement system of the transmission loss characteristic for the basic element as shown in Figure 1 by using a

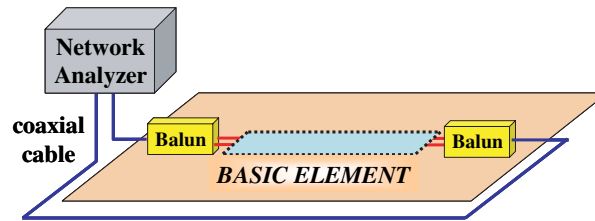

Figure 2. Measurement system of transmission loss characteristic.

network analyzer. The electric power line composing the basic element is transmission line with balance type, but a coaxial cable from the network analyzer is transmission line with unbalance type. Therefore, we used a balun at the connected point of the electric power line and the coaxial cable. The measurement frequency is from 1 MHz to 100 MHz corresponding to the assurance frequency of balun.

Figures 3 and 4 show the measurement results of transmission loss characteristics for the basic element. The insertion loss of

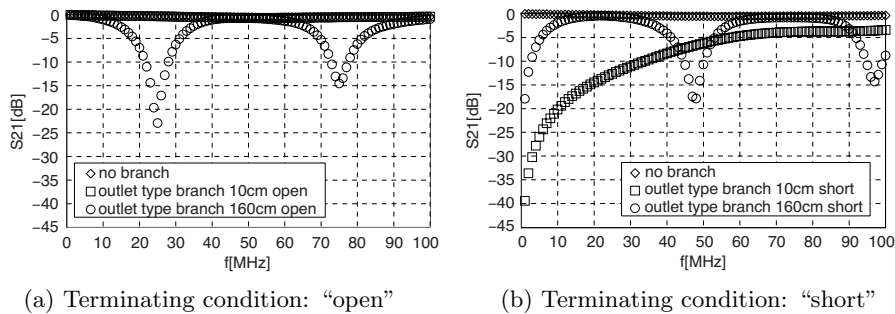

Figure 3. Transmission loss characteristics of power line (Outlet type branch).

balun is subtracted from the measurement value of the transmission loss by using normalizing function of the network analyzer. First, the characteristic for “outlet type branch-open” in Figure 3(a) has approached the characteristic for “no branch” by decreasing in branch length. On the other hand, sharp attenuation like the resonance appeared on the low frequency band by increasing in branch length. Especially, the transmission loss reaches up to 20 dB around the

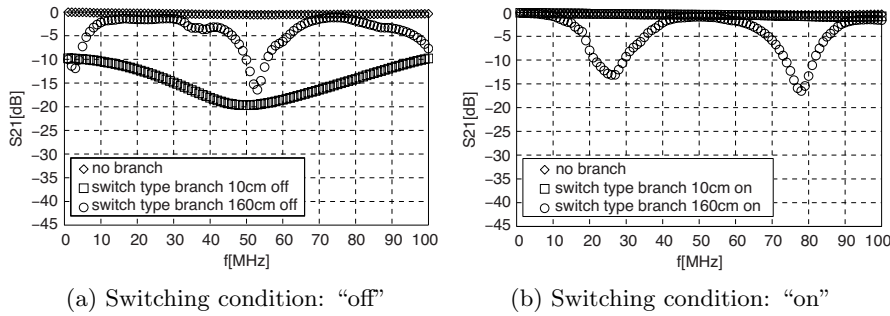

Figure 4. Transmission loss characteristics of power line (Switch type branch).

frequency of 24 MHz when the branch length is 160 cm. This band is used with the PLC modem. Next, the transmission loss for “outlet type branch-short” in Figure 3(b) becomes very large on the low frequency band according to decreasing in branch length. The transmission loss at the branch length of 10 cm became 25 dB at the frequency of 5 MHz, but the transmission loss is improved as the frequency become higher. In addition, the transmission loss at the branch length of 160 cm is not so large in all frequency band. On the other hand, the transmission loss for “switch type branch-off” in Figure 4(a) is very large in all frequency band, the maximum transmission loss reaches 20 dB around the frequency of 50 MHz when the branch length is 10 cm, because one of two lines is disconnected. But, transmission loss is improved according to increasing branch length. The transmission loss characteristics for “switch type branch-on” in Figure 4(b) are similar to that for “outlet type branch-open” in Figure 3(a) in the all frequency band.

Though this model as shown in Figures 1 is small-scale, the basic characteristics of an electric power line can be measured. Therefore, it is thought that this model is applicable as an electric power line model in the transmission measurement using the PLC modem as shown in paragraph 3.

2.3. Measurement of Group Delay Characteristic

The group delay can be calculated by the following expressions.

$$\Delta t[s] = -\frac{d\phi}{df}$$

The group delay reaches a constant value if a transmission media has a linear characteristic. Oppositely, the group delay increases if the transmission media has the nonlinearity. As an influence of the group delay to the transmission characteristic, it is considered that the guard interval length on the transmission system using OFDM is affected by the group delay. Therefore, it is very important to understand the amount of the change of the group delay, and evaluate the transmission characteristic from such a viewpoint.

Figures 5 and 6 show the measurement result of the group delay characteristics. In the case of “outlet type branch 160 cm open”

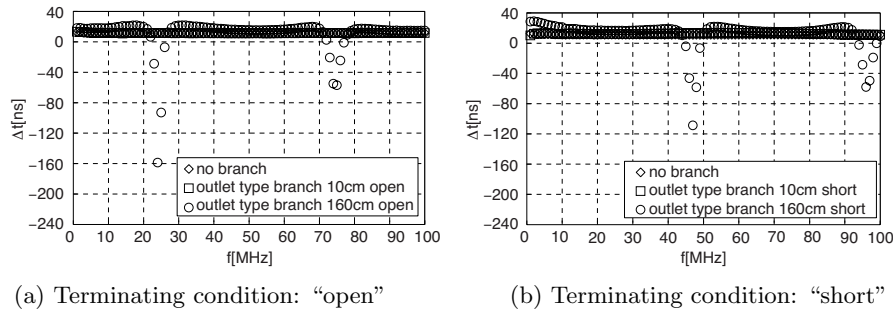

Figure 5. Group delay characteristics of power line (Outlet type branch).

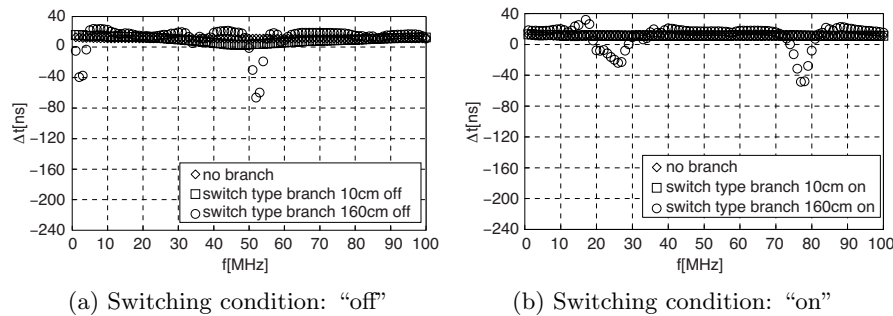

Figure 6. Group delay characteristics of power line (Switch type branch).

as shown in Figure 5(a), the group delay changes sharply at the frequencies of 24 MHz and 75 MHz, which correspond the frequency occurring sharp attenuations like resonance in transmission loss characteristic for the same branch condition as shown in Figure 3(a). On the other hand, in the case of “outlet type branch 10 cm short” as shown in Figure 5(b), the group delay around low frequency band does

not change in spite of large transmission loss around the same frequency band as shown in Figure 3(b). And, there is a similar tendency in the case of “switch type branch 10 cm off” as shown in Figure 4(a). In this case, the transmission loss is large at all frequency band, but the group delay does not change as shown in Figure 6(a). It is clear from these results that the group delay characteristic does not relate the amount of the transmission loss, but the change of the transmission loss.

3. TRANSMISSION CHARACTERISTICS MEASUREMENT SYSTEM OF OFDM SIGNAL USING PLC MODEM

3.1. Measuring Method of Transmission Characteristic with Modem

We measured the transmission characteristic for the OFDM signal using PLC modem made of Sumitomo Electric Industries, LTD. Figure 7 shows the measurement system. Sending and receiving PCs are connected through the PLC modem and each model of the transmission line as shown in Figure 1. The bandwidth of the PLC modem is from 4 to 34 MHz. Next, the communication link between sending and receiving PCs through the modem is established and measured PHY rate (Physical rate). The measurement system set in a G-TEM (Giga-Hertz Transverse Electromagnetic) cell in order to suppress power supply coupling between sending and receiving modems. Normally, PLC modem is connected to AC power line, but in this case, the measurement system connected to DC power line as shown in Figure 7 is provided to suppress the power supply coupling. We considered on a grand side, and each electric power line in the GTEM Cell is set above 10 cm high from a metal floor of the GTEM cell, in order to suppress the influence of the metal floor.

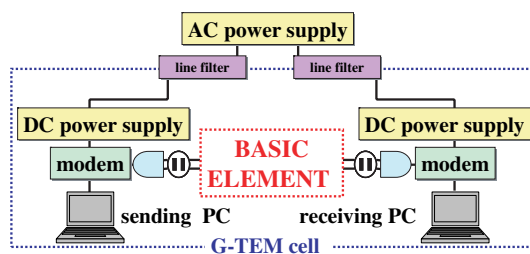

Figure 7. Transmission characteristics measurement system of OFDM signal using PLC modem.

3.2. Method of Simulating Transmission Characteristics Using PLC Modem

First, we modeled the PLC modem with the computer software and composed the OFDM sending and receiving system and simulated the transmission characteristics of the OFDM signal, that is, PHY rate for the electric power line as shown in Figure 1. Figure 8(a) shows the simulation block chart of the OFDM sending and receiving system and, Figure 8(b) shows that of the mock electric power transmission line. It is assumed that the sending and receiving systems are composed by the OFDM system based on a general FFT (Fast Fourier Transform)

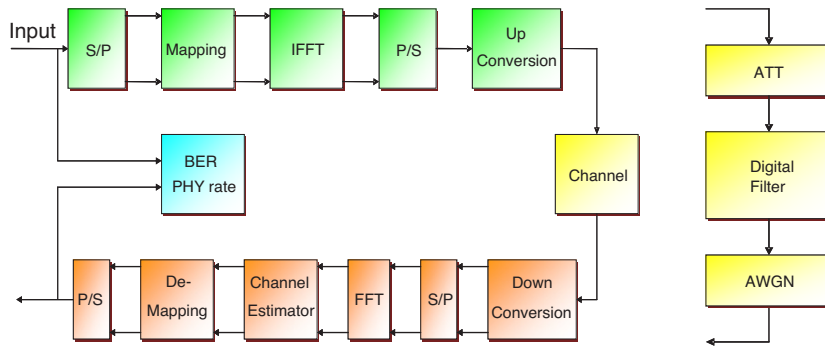

Figure 8. Simulation model of transmission characteristics for OFDM signal using PLC modem.

[13, 14]. First, the input random binary signal is converted into the frame data in the S/P (Serial/Parallel) block, and converts into a multilevel symbol by QAM (Quadrature Amplitude Modulation) in the Mapping block for each sub-carrier. Next, Orthogonal transform is processed in the IFFT (Inverse Fast Fourier Transform) block. As a result, base-band OFDM signal is generated, and converted into the pass-band signal by the Up-Conversion block. Here, the Channel block consists of Figure 8(b), and the composition is as follows. Wideband and constant signal attenuation are imitated in the ATT (attenuator) block. In the Digital Filter block, each electric power line is composed by using the measurement data of the transmission loss and the group delay characteristics. Moreover, the thermal noise of the equipment is imitated by the AWGN (Additive White Gaussian Noise) block. On the other hand, the receiving system is reversely converted about the sending system. The receiving signal is equalized by the Channel Estimator block. The equalization method is division of the complex number that uses the pilot-carriers. Finally, the receiving binary data

is compared with the sending binary data and BER (Bit Err Rate) is calculated. PHY rate is calculated from the receiving bits and the sample rate. Receiving bits are the subtraction of the error bits from all sending bits. For the simulation parameter, we calculated by using the simplified model compared with an actual modem because each parameter used for the actual modem is not obtained as public information. Therefore, the calculation of PHY rate is adjusted to measurement data when using the parameter as shown in Table 1.

Table 1. Simulation parameter for OFDM signal using PLC modem.

number of sub-careers	1400
first modulation	1024QAM=10 bits
use band	4 M~34 MHz
sub-career interval	43 kHz
maximum PHY rate	186 Mbps
symbol length	23 μ s
guard interval length	360 ns
AWGN	S/N=50 dB

3.3. Measurement and Calculation Results of Transmission Characteristic Using PLC Modem

Table 2 shows the results of PHY rate corresponding to each basic element as well as their termination conditions, and the calculated values agree well with the measured values. It became clear that basic element (b) with termination condition of “10 cm short” influences most for the PHY rate and basic element (c) with termination condition of “160 cm on” influences next. It is thought that the transmission loss was the largest in the use band of the modem. Therefore, it is clear that the transmission loss is main factor for decreasing PHY rate. On the other hand, when comparing “outlet type branch 160 cm open” with “switch type branch 160 cm on”, PHY rate for “switch type branch 160 cm on” was lower. Oppositely, variable quantities of the group delay characteristic for “outlet type branch 160 cm” were larger. Therefore, it is considered that PHY rate is hardly influenced if the amount of the group delay is below guard interval length. In fact, PHY rate of PLC modem is most affected in the case of the power line transmission characteristics having broad band and high level attenuation.

Table 2. Measured and calculated results of PHY rate for PLC modem.

basic element and termination condition	PHY rate [Mbps]	
	meas.	calc.
(a) no branch	183	186
(b) outlet type branch 10 cm open	181	186
(b) outlet type branch 10 cm short	166	170
(b) outlet type branch 160 cm open	178	180
(b) outlet type branch 160 cm short	181	186
(c) switch type branch 10 cm off	180	185
(c) switch type branch 10 cm on	181	186
(c) switch type branch 160 cm off	183	186
(c) switch type branch 160cm on	168	171

4. CONCLUSION

In this paper, we measured and calculated what influence the transmission characteristics of the electric power line with basic element gave to the transmission characteristic of OFDM signal through PLC modem. The following items are clear by comparing with the measurement and the calculation values:

- (a) The electric power line transmission line with various forms in a real environment is classified into two basic elements, which are an outlet type branch and a switch type branch. Therefore, even if a small-scale electric power line model is used, it is able to measure the characteristic of large-scale and complicated electric power line.
- (b) PHY rate of PLC modem is most affected in the case of the power line transmission characteristics having broad band and high level attenuation and is not affected in the case of that having narrow band group delay variation.

In future, it is necessary to examine transmission characteristic for OFDM signal by using a complex transmission line model.

REFERENCES

1. ECHONET CONSORTIUM, "ECHONET Specification Version 2.11," ECHONET, April 2002.
2. Goldberg, G., "Evaluation of power line communication systems," *Proceedings 15th International Wroclaw Symposium on Electromagnetic Compatibility*, 103–106, June 2000.
3. Hansen, D., "Megabits per second on 50 hz power lines," *Proceedings 15th International Wroclaw Symposium on Electromagnetic Compatibility*, 107–110, June 2000.
4. Matsumoto, W., "The power line communication modem by the dispersed tone modulation method which is applied multicarrier data transmission technology," *The IEICE Transaction on Communications*, Vol. J84-B, No. 1, 38–49, January 2001 (in Japanese).
5. Tokuda, M., "Technical trends in high-speed power line communication," *The IEICE Transaction on Communications*, Vol. E88-B, No. 8, 3115–3120, August 2005.
6. Koga, H., N. Kodama, T. Konishi, and T. Gondo, "Power line communication experiment using wavelet OFDM modem," *Electronics, Information and System Society Conference*, OS1-1, Sept. 2004 (in Japanese).
7. Richards, J. C., "Characterization of access broadband over power line (BPL) systems by measurements," *2005 IEEE International Symposium on Electromagnetic Compatibility, Proceedings*, Vol. 3, 982–987, August 2005.
8. Cohen, L. S., J. W. de Graaf, A. Light, and F. Sabath, "The measurement of broad band over power line emissions," *2005 IEEE International Symposium on Electromagnetic Compatibility, Proceedings*, Vol. 3, 988–991, August 2005.
9. Hare, Ed., "Measurements and calculations of BPL emissions," *2005 IEEE International Symposium on Electromagnetic Compatibility, Proceedings*, Vol. 3, 992–995, August 2005.
10. Shiozawa, H., Y. Watanabe, and M. Tokuda, "Calculation of radiated emission from the power line by 4-terminal pair network theory," *2005 IEEE International Symposium on Electromagnetic Compatibility, Proceedings*, Vol. 3, 996–1001, August 2005.
11. Miyoshi, K., N. Kuwabara, Y. Akiyama, and H. Yamane, "Calculation of radiating magnetic field from indoor ac main cable using four-port network," *2005 IEEE International Symposium on Electromagnetic Compatibility, Proceedings*, Vol. 3, 1002–1007, August 2005.

12. Watanabe, Y. and M. Tokuda, "Influence of ground plane to distance dependence of leaked electric field from power line," *2005 IEEE International Symposium on Electromagnetic Compatibility, Proceedings*, Vol. 3, 1008–1013, August 2005.
13. Triceps Planning Department, "Power line communication system," Triceps Co., 2002 (in Japanese).
14. Triceps Planning Department, Triceps Co., 2000 (in Japanese).