

The Relationship Between Electromyography and Muscle Force

Heloyse Uliam Kuriki, Fábio Mícolis de Azevedo,
Luciana Sanae Ota Takahashi, Emanuelle Moraes Mello,
Rúben de Faria Negrão Filho and Neri Alves
*Univ. Estadual Paulista
Univ. de São Paulo
Brazil*

1. Introduction

The generation of physical movement in animals involves the activation and control of muscle forces. Understanding the mechanisms behind force generation and control is essential for professionals who work to promote health. The human body can be represented as a system of articulated segments in static or dynamic balance. Within this system, movement can arise from internal forces acting outside the joint axis, causing angular displacement of these segments, or by forces external to the body. Knowledge of the contribution of muscle forces to joint position and movement is of great importance for the study of muscle activity during exercise and also for understanding the coordination of muscle activities during functional movement. However, muscles forces cannot be easily measured *in vivo*; rather, they must be assessed, calculated or modeled (Amadio & Duarte, 1996; Amadio & Barbanti 2000).

Closely associated with the generation of force by a muscle, is the generation of an electrical signal that can be observed by placing electrodes on the skin surface to detect underlying electrical activity displaying the associated waveform on a computer monitor. This process is called electromyography (EMG) and the waveform is the electromyogram. The assumption that there is an association between EMG and underlying muscle forces is the basis for many applications of EMG, allowing inferences regarding various aspects of muscle physiology. However, it is not possible to measure muscle force directly using EMG. Since 1952 there have been studies that show some cases where there is a linear relationship between force and EMG (Lippold, 1952), however this relationship is not always simple and linear. In recent years methods for detecting and processing EMG signals have been refined considerably, with the availability of better equipment, tools, mathematical, statistical and computational techniques. Although the determination of muscle strength using EMG measurements has also evolved, it has not yet fully exploited the technological potential available. In this chapter, we describe a practical approach to the quantitative evaluation of muscle force through analysis of the EMG signal.

2. Muscle strength

Force is a fundamental concept, understood as an agent capable of modifying the state of rest or motion of a body. Force can be defined as:

$$F=m.a \quad (1)$$

where m is mass and a , acceleration.

Animals move and interact with the environment generating muscleforce, either voluntarily or passively. Biomechanics is a field of science dedicated to understanding human movement and the study of the muscular forces involved in human movement. It is the application of mathematical principles, laws and concepts to mechanical, biological systems. It studies the generation and performance of internal and external forces on these systems and the effects of these forces on each part of the body. These forces can be calculated indirectly by parameters of kinematics and dynamics of movement or based on the mechanical characteristics of the locomotor system and its functional structures. External biomechanics refers to externally observable characteristics of the body studied, for example, its movement in space: position, velocity, acceleration, externally applied forces, reaction forces and muscle electrical activity (Amadio & Duarte, 1996; Amadio & Barbanti, 2000).

The muscle behavior approach to biomechanics uses analytical methods that include anthropometry, kinemetry, dynamometry and electromyography. The EMG is the method of recording the electrical activity of a muscle, including information about the physiological processes that occur during muscle contraction. The biological structure of the body, movement dynamics and characteristics of the measurement techniques complicate the analysis of the motion variables and indicators of internal phenomena. The assessment of muscle strength, in particular, becomes more complex due to the mechanisms of controlling dosage or magnitude, enabling the execution of movements or of achieving internal and external balance amongst body elements. Thus, direct measures of muscle strength and interaction forces between segments are not viable. Assessments of internal forces are based on models built from the parameters of motion of the body or its segments, measures of external linkages, or both. Understanding the relationships between internal forces and movement is one of the major methodological challenges for biomechanics (Amadio & Duarte, 1996).

3. Determinant factors for the generation of muscle strength

The term muscle strength refers to the ability of a muscle to generate tension. For the generation of muscular force that produces mechanical work, the first necessary condition is nerve stimulation that triggers the process. Sensory input from muscles travels via afferent pathways to the central nervous system (CNS), where it promotes the recruitment of motor neurons that stimulates muscle fibers and results in the generation and demonstration of muscle strength. These muscle forces act through a bone system that depend on nervous, muscular, and biomechanical factors, as shown in Figure 1.

The functional unit of muscle is the motor unit (MU), which consists of an alpha motor neuron and all fibers innervated by it. Muscle fibers are the structural unit of contraction. One UM can have from 3 to 2000 muscle fibers, depending on the degree of control and strength required by the muscle: muscles that control fine movements and require precise but low strength have fewer fibers per MU, whereas the large muscles that control larger movements requiring greater strength, may contain 100 to 1000 fibers per MU (Rash, 2002).

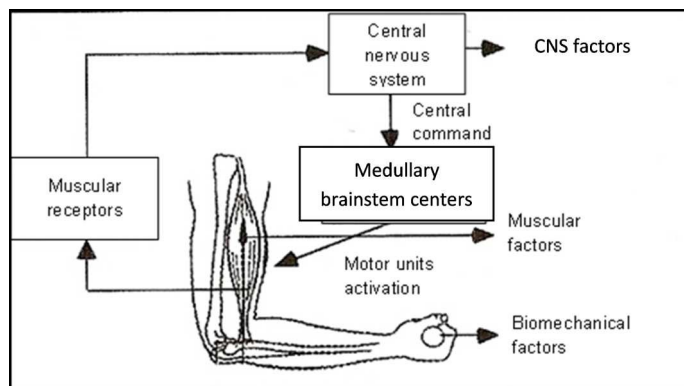

Fig. 1. Diagram illustrating the factors associated with muscle force generation.

The contraction of muscle fibers occurs when action potentials are generated in the motor neuron that supplies them. When the action potential reaching the motor neuron and axon terminal exceeds the threshold of depolarization in the postsynaptic membrane of the neuromuscular junction, it becomes a muscle action potential. Different from nerve action potentials, the muscle action potential is propagated in both directions of the muscle fiber, triggering the process of the sliding of actin filaments on myosin, the major contractile proteins of the myofibrils, thus, promoting muscle contraction (Fox & Keteyian, 2000).

During voluntary contractions, muscle force is modulated by the central nervous system, which combines recruitment with the frequency of MU activation and synchronization. MU recruitment involves the control of the number and type of fibers activated. The frequency of activation of MUs refers to the fact that the fibers do not remain contracted, relaxing after each activation, and therefore reflects the repeatability of activation. The synchronization of activation refers to the temporal coincidence of the pulses of two or more MUs firing in combination. The greater the ability to recruit MUs simultaneously, the greater the force produced by the muscle (Barbanti et al., 2002; Fox & Keteyian, 2000). These mechanisms operate in different proportions depending on the muscle. Relatively small muscles, such as those of the hand; and big muscles, like those of the legs and arms are controlled by different schemes of recruitment and activation (Basmajian & De Luca, 1985).

Muscle fibers are classified either as type I or type II, according to their metabolic and functional capabilities. As the number of MUs per muscle is variable, the ratio of fiber types varies among individuals (Rash, 2002; Fox & Keteyian, 2000). Type I fibers are recruited first during muscle contraction, and are always active regardless of exercise intensity. Type IIA fibres are recruited next, and, with higher levels of exercise demand, type IIB are recruited. Type II fibers are typically recruited during tasks involving rapid effort, high power and high intensity (Fox, Keteyian, 2000; Gerdle et al., 1991).

Muscle strength is also influenced by the contractile and elastic structure of the muscle itself. The contractile units refer to the proteins of the functional units of the muscle, the sarcomeres, containing filaments of actin and myosin. An elastic component is present in the connective tissue sheaths surrounding the muscle (epimysium), the bundles of muscle fibers (perimysium) and the interior of the muscle fiber (endomysium), which join at their ends to form tendons. During concentric muscle contraction, there is a slip of actin filaments on the myosin filament; the filament length remains constant, but the muscle length decreases.

Instead, during the eccentric contraction, muscle length is increased. And during an isometric contraction, slippage of the contractile elements occurs and elastic strain arises, i.e., muscle work is performed, although there is no movement observed (Fox & Keteyian, 2000; Nordin & Frankel, 2001). Muscle strength depends on the length of the muscle. When the actin and myosin overlap along their entire lengths, the number of crossbridges reaches its maximum, allowing the muscle to generate maximum tension. The length at which force is produced with the greatest intensity varies between different muscles within a single individual, but does not change in the same muscle across different individuals (Mohamed et al., 2002; Nordin & Frankel, 2001).

In addition to the generation of active tension through the sliding of the filaments, there is the phenomenon of passive tension, which arises from the stretch of connective or elastic tissue (or elastic). As muscle length shortens, these passive elements become "loosened" and their contribution to muscle tension decreases gradually as tension subsides (Mohamed et al., 2002). In addition to neural and muscular components there are biomechanical factors, which can influence muscle action of muscle without direct relationship to power generation. Such factors include angular variations of the joint and different types and levels of resistance that may be applied. In a biomechanical system involving two muscle segments and a joint, variation of joint angle determines the degree of mechanical advantage that a limb has when generating force. The perpendicular distance between the axis of the joint and tendon line of action defines this mechanical advantage. The outer lever refers to the distance between the joint axis and the point at which resistance is applied, and changes when the joint angle is modified. There are different types of overload that can be applied to a limb such as those produced by fixed weight, elastic resistance and isokinetic [isokinetic WHAT?]. The action of a muscle, of course, responds differently to each overload imposed. This answer depends on the multiplier or reducing effect of the internal and external lever system, as well as the speed of the gesture in question. These factors are all interconnected. The angular variation of the limb is directly related to the change in muscle length.

Knowing all the variables that can influence muscle strength, we are able to propose a model for its calculation. In this chapter we base the calculation of muscle strength to the quadriceps muscle during isometric and isotonic exercises, in the position showed in figure 2.

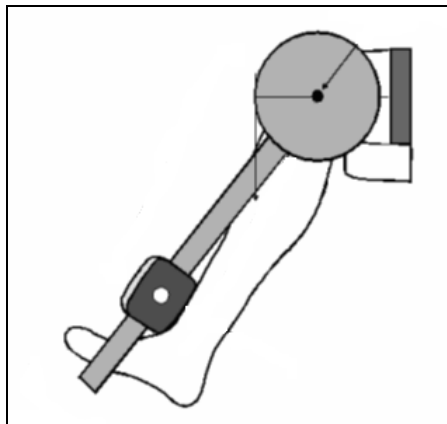

Fig. 2. Schematic diagram of the exercise. For the isometric contraction the movement occurs against a fixed resistance and for the isotonic the knee is able to execute the extension.

4. Experimental protocol

We will illustrate the lever model using the example of the quadriceps muscle. To calculate the strength of the quadriceps muscles, three steps are needed: i) a theoretical simulation of muscle force based on biomechanical models, ii) experimental testing to determine the curve of maximal isometric strength of knee extension as a function of joint angle, and iii) analysis of the internal relationship between muscle strength and the EMG signal during isometric and isotonic exercises. These steps will be detailed below:

4.1 Simulation of muscle strength

The adoption of an appropriate biomechanical model of the knee joint is essential to measure the forces transmitted by these muscles to the skeletal system. In the muscle model of Hill (Hof & Van Den Berg, 1981) force is described to be made up of three components: i) a parallel elastic component (PEC), which represents the elasticity of the passive elements of the muscles and ligaments ii) a contractile component (CC), which determines the behavior of active elements of the muscle, and iii) elastic components connected in series (SEC). These components should not be construed as if each one corresponds to a separate constituent of the muscle structure. Figure 3 shows a representation of the Hill model. The length of the elements is expressed by the relation:

$$x = l - l_0 \tag{2}$$

where l is the length at a given moment, and l_0 is the length in the resting position.

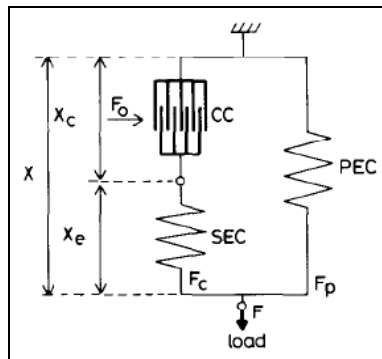

Fig. 3. Schematic diagram of Hill model.

The modeling of the motor unit will be discussed in a later section of this chapter. First we describe the contribution of contractile and passive components to force generation. The intensity of each component depends on the length of the muscle in a non-linear and non-monotonic way, as shown in Figure 3. Passive elastic force (curve 1, fig. 4) is exerted by the elastic components and contractile force is generated by the contractile proteins (curve 2, fig. 4). The sum of these two components produces the curve 3, which represents the overall strength of the muscle as a function of its length. The curve illustrates that maximum force is generated when the muscle is stretched to approximately 1.2 to 1.3 times its resting length. This position often coincides with the length of the muscle in a relaxed state. It appears that the anatomical architecture of the musculoskeletal system is organized for the benefit of the force-length relationships of the muscular system (Basmajian & De Luca, 1985).

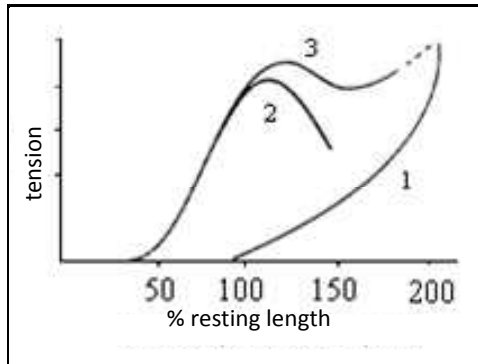

Fig. 4. Force-length curve for an isolated muscle.

In addition to length-dependent characteristics of strength, there are also speed-dependent properties. The ability to generate muscle force depends on the speed and type of contraction. Thus, movements in concentric, eccentric and isometric contractions illustrate important differences in force behavior (Figure 5) (Barbanti et al., 2002). The ability of a muscle to generate force is higher in an isometric situation (contraction velocity equal to zero) than in a concentric contraction, and this capacity decreases as the speed of contraction increases. The velocity of shortening that a muscle can produce is at its maximum when the external load is zero, but as the load increases, muscle shortening slows until the external load is equal to the maximum force that the muscle can exert (isometric contraction). If the load continues to increase even more, the muscle will contract eccentrically. During an eccentric contraction, the muscle can develop tension higher than in isometric contraction, and in this case the force increases with speed of muscle contraction (Barbanti et al., 2002; Nordin & Frankel, 2001).

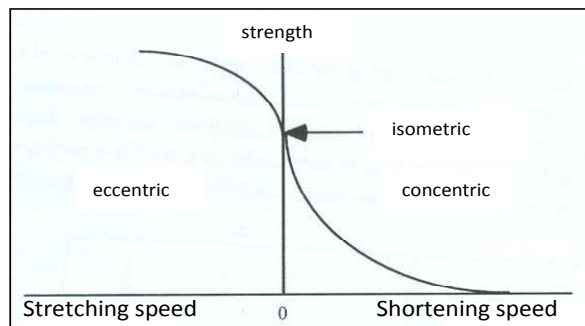

Fig. 5. Force-velocity curve for an isolated muscle.

An equation that describes the curves shown in figures 3 and 4 can be derived from the Hill model shown in figure 3. The force F that represents the total force generated by the muscle is given by:

$$F = F_c + F_p \quad (3)$$

where F_c is the contractile component in series and in the passive state (CC and SEC) and F_p is the force provided by parallel components (PEC).

As previously discussed, the force generated by the parallel components grows exponentially, so can be expressed by:

$$F_p(x) = F_{p0}e^{px-1} \quad (4)$$

where x is the total length of the muscle, F_{p0} and p the parameters of the exponent.

This relationship represents the properties of muscle, tendon, ligament and joint when a muscle is not active. Normally passive forces have significant values when the muscle is close to the greatest or smallest possible length. Contractile force, as discussed, depends on speed, and can be described by the following equations:

$$F_c = F_0 f(x_c) - n v_c b + v_c b, \text{ for } v_c > 0 \quad (5)$$

$$F_c \leq (1+c)F_0 f(x_c), \text{ for } v_c < 0 \quad (6)$$

where v_c is the velocity of shortening of the muscle and x_c is the length of the contractile component shown in Figure 3, $f(x_c)$ is a function of normalization to values between 0 and 1 and F_0 is the F_c value when $f(x_c)$ is maximum. The F_c values decrease with increasing v_c for $v_c > 0$ and the rate of decrease depends on the parameter b , while n defines the concavity of the curve. For values of $v_c > 0$, the force F_c is greater than in the isometric case, where the difference is given by the parameter c .

Through these equations, it can be seen that the Hill model provides a very close representation of experimentally observed muscle behavior.

The muscle strength in the isometric activity, that is, when v_c is equal zero, can be seen from equations 4, 5 and 6. These equations can then be rewritten to reflect isometric contraction.

$$F_c = F_0 f(x_c) \quad (7)$$

Then

$$F = F_0 f(x_c) + F_{p0}e^{px-1} \quad (8)$$

In this last equation it can be observed that in isometric activity, muscle strength depends on the length of the muscle, and that the diagram from figure 2 is represented by $x = x_e + x_c$. Thus, it can be appreciated that during so-called isometric contractions there is actually considerable variation in the lengths of the contractile elements of the muscle (x_c).

4.2 Calculation of muscle strength (biomechanical models)

Several biomechanical models have been constructed to represent the performance of the musculoskeletal system in various situations of interest to sports, clinicians or others. The representations include two-dimensional approaches, to complex computer simulations that produce quantitative and three-dimensional visual representations. Currently available computing resources, including those intended for graphic animation, allow for the development of powerful tools for motion analysis. There are softwares that enable the user to develop detailed musculoskeletal models with representations of bones, muscles, ligaments and other structures. It is also possible to input experimental data regarding motion to some of these softwares, through direct or inverse dynamics, and to calculate muscle forces and visualize the geometric changes of the musculoskeletal system.

The relation between strength applied externally by a limb and the muscle strength is, however, not obvious. To illustrate, we will consider the calculation of quadriceps strength during leg extension (concentric contraction) in the sitting position, with an external resistance applied perpendicular to the leg. To calculate the strength, we use a simple two-dimensional model of the quadriceps. The free body diagram is shown in figure 6, where L_p is the length of the leg, L_{cm} the longitudinal position of the center of mass, F_{pl} the force applied to the tibial tuberosity through the patellar ligament, F_c the contact tibio-femoral force, γ the angle between the patellar ligament and the axis of the leg, θ the angle of the knee joint, W_p the weight of the leg and F_a the external force applied perpendicular to the limb.

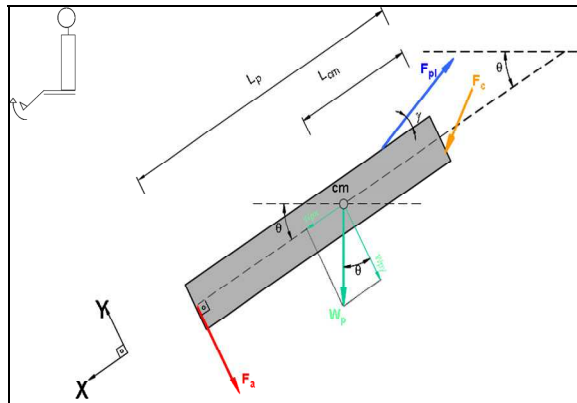

Fig. 6. Free body diagram representing the leg of a sitting person in a movement of concentric contraction of the quadriceps.

Through geometrical considerations illustrated in the free body diagram and calculation of torque, in which $\Sigma\tau = I\alpha$, and τ the torque, I the moment of inertia and α the angular acceleration, an equation can be written that defines the strength of the quadriceps muscle as a function of joint angle θ .

$$F_q = L_p F_a + L_{cm} W_p \cos\theta + I \alpha R B_m \quad (9)$$

In this equation, F_q is the force exerted by the quadriceps, I is the moment of inertia of the leg, α is the angular acceleration during exercise and B_m is the moment arm of force of the patellar ligament in relation to the point of tibiofemoral contact, around which the femur rotates. It must be recognized that the point of rotation changes as a function of the angle θ , and consequently the moment arm also changes. The relationship between the strength of the patellar ligament and the force exerted by the quadriceps is called R ($R = F_{pl}/F_q$) and also varies with the joint angle θ .

Figure 7 shows the strength of the quadriceps calculated for different forces applied perpendicular to the leg, considering a female individual, typical for the anthropometric model adopted (De Leva, 1996), with mass of 61.9 kg and height of 1.73 m. In these simulations using the values of R and B_m obtained by Van Eijden et al. (1986) and Kellis and Baltzopoulos (1999), respectively, the experimental condition assumed that the angular velocity was constant - $W = ct$ and $\alpha = 0$. The model was developed considering that the

external force is always applied perpendicular to the limb and, therefore, remains constant. It can be observed that, while the leg moves a certain weight through the range of motion, the quadriceps displays variable strength. With this simple model, it is only possible to assess the strength of the muscle group, not each component part, (in this case, the vastus medialis, vastus lateralis, vastus intermedius and rectus femoris muscles).

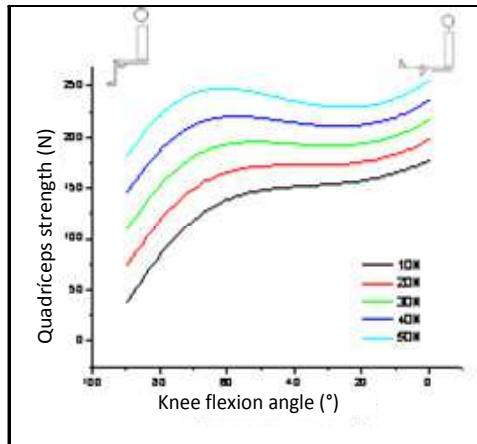

Fig. 7. Simulation of the quadriceps muscle strength in knee extension exercise in sitting position.

The maximum force that a limb is able to apply externally varies with angular position. This is because the geometrical arrangement determines the degree of mechanical advantage, and also because changes in muscle length alter the efficiency of muscle force generation, in addition to the the different contributions of different components of the muscle group.

Figure 8 shows the maximum force applied externally by a leg during isometric contraction of the quadriceps. In the same graph the corresponding force generated by the quadriceps

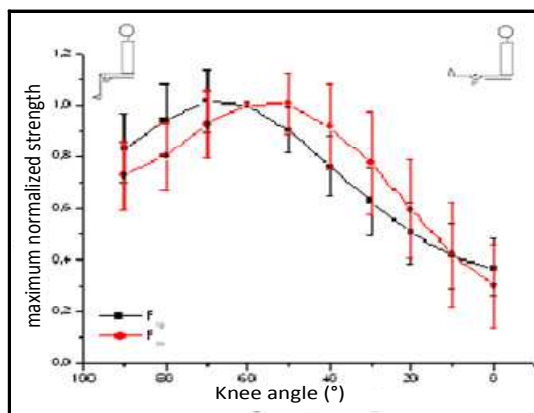

Fig. 8. Values of the applied force and muscle strength normalized as a function of the knee joint angle (average of 10 individuals).

muscle group is shown, calculated by the model (equation 9). The values are normalized by the strength at a 60° angle and were obtained from 10 female volunteers, with a mean age of 20.4 ± 1.6 years, mean weight of 51.15 ± 6.72 kg and mean height of 1.66 ± 0.05 m, during cued isometric contractions, with the maximum force defined as the greatest force exerted across three repetitions.

4.3 General considerations on the assessment of muscle strength

In the preceding sections, we have discussed aspects related to muscle force generation, presenting briefly the main factors - nerve, muscle and biomechanical - that determine the ability to generate muscle force. We have qualitatively discussed the participation of active and passive elements of muscle and shown that the force generated by a muscle can be represented by the Hill model. To understand the role of muscle force generation in movement, it is necessary to refer to biomechanical models. This was then demonstrated using a simple model of the quadriceps, in which we calculated the force exerted by this muscle when the leg applies an external force. Then, results were presented showing the maximum strength of the quadriceps as a function of joint angle in isometric contractions. Starting from the theories of force generation in muscle fibers, it is not easy to understand the internal force exerted by a muscle, when it involves a complex articulation, such as the quadriceps. One very important consideration for health professionals involves the participation of each portion of the muscle in force generation as a function of angular position. For example, figure 9 shows how the different portions of quadriceps acting on the knee extension.

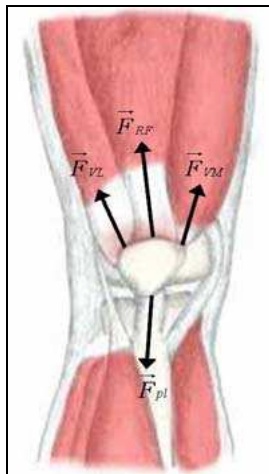

Fig. 9. Illustrative schema of how the forces of each portion of the quadriceps acts during the contraction.

The EMG signal is recorded by electrodes in response to muscle activity. As previously mentioned, skeletal muscle cells are formed by the muscle fibers, which constitute the structural contractile units. Each fiber, if excited, has the ability to stretch or contract. The activation of the muscle fiber by nerve endings induces two waves of depolarization that travel at a speed of 3 to 6m/s. The internal tissue is electrically conductive. Thus, electrical

signals related to depolarization of the fiber can be recorded by electrodes on the skin or muscle.

Two events occur simultaneously during muscle contraction: one electrical and one mechanical. Depolarization releases calcium ions, which starts the process of contraction in the main body of the muscle fiber. But this contraction is much slower than the cycle of depolarization, which occurs over approximately 2 ms. Maximum forces are achieved between 20 to 150ms after depolarization and then decaying gradually due to reabsorption of calcium. Consequently, it cannot be said that there is a direct relationship between EMG and force.

In muscle contraction, the degree of force can be controlled by changes in the number of recruited MUs or by changes in the frequency of recruitment. To increase the strength of a muscle the number of fibers recruited must increase one by one in order of size (size principle). After recruitment of all fibers, force can be further increased by increasing the frequency of activation. The EMG signal is a record of action potentials produced during a muscle contraction. The action potential motor unit (APMU) is the temporal and spatial summation of individual action potentials of all fibers of a MU. However, the catchment area of an electrode will often include more than one MU, because the muscle fibers of different MUs are interwoven throughout the muscle. Any portion of the muscle may contain fibers belonging to 20-50 MUs. An electrode located in this field will detect the algebraic sum of several APMUs within its catchment area. In order to maintain muscle contraction, the nervous system sends a sequence of stimuli, so that the MUs are activated repeatedly, resulting in a train of APMUs. The EMG signal is the superposition of the resulting space-time relationship of these trains, considering the number of MUs involved for maintenance and activation of muscle contraction.

4.4 Relationship between EMG and force

The relationship between force and surface EMG during voluntary contractions is not well understood. Some authors have concluded, for various muscles, that the magnitude of the EMG signal is directly proportional to muscle strength for isometric and/or isotonic contractions with constant speed, but others claim that this relationship is not linear (Bilodeau et al., 2003; Gerdle et al., 1991; Gregor et al., 2002; Herzog et al., 1998; Karlsson & Gerdle, 2001; Moritani & Muro, 1987; Onishi et al., 2000). In most cases, the EMG increases non-linearly with increasing force of muscle contraction (Guimaraes et al., 1994; Madeleine et al., 2000; Lawrence & De Luca, 1983; Solomonow et al., 1990). Theoretical analyses suggest that the amplitude of the signal in isometric contraction should increase with the square root of the force generated if the motor units are activated independently (Basmajian & De Luca, 1985; Lawrence & De Luca, 1983). This variety of different interpretations among researchers not surprising, given the inherent limitations of surface EMG. The measured force of muscle contraction is a result of the global activity of the underlying muscle fibers, and surface EMG provides information about the electrical activity of motor units located in the region near the electrode; in most experiments, the catchment area of the electrode does not extend sufficiently to detect the signal generated across the entire muscle volume (De Luca, 1997; Siegler et al., 1985).

Factors that prevent the direct quantification of muscle force from EMG signals include cross-talk, variations in the location of the recording electrodes and the involvement of synergistic muscles in force generation.

The electrical cross-talk of adjacent muscles is often considered as a possible factor that complicates the determination of the relationship between EMG and force. Its influence would manifest most prominently when the measured strength of the muscle increases. The presence of cross-talk is more dominant in smaller muscles where the electrodes (especially the surface) must be placed close to the adjacent musculature. The complexity of cross-talk is also determined by the anisotropy of muscle tissue and homogeneity of the tissues adjacent to the muscle. Often it is not possible to identify precisely the source of contamination of the physiological signal.

The degree of synergistic action of other muscle groups and the amounts of co-contraction between antagonistic muscle groups can change the contribution of muscle strength in research on the net force measured in the joint (Lawrence & De Luca, 1983). Ideally, in order to improve the EMG-force relationship, the muscle chosen should be the muscle uniquely responsible for generating the force measured (Bigland-Ritchie, 1981).

The relative location of fast and slow muscle fibers inside the muscle, and their distribution and location relative to the electrode are also factors to be considered. The amplitude of the action potential generated by a single muscle fiber is proportional to its diameter. Fast fibers generally have larger diameters and display a greater range of action potentials than slow fibers, and consequently generate a higher signal amplitude. However, the amplitude of the action potential, is a function of the distance between the active fibers and the recording electrodes, and the greater the distance, the lower the measured amplitude. The largest motor units, containing the largest diameter of fast twitch fibers are preferentially recruited at high force levels, according to the size principle (Henneman et al., 1965; Henneman & Olson, 1965). Thus, the relative location of fast muscle fibers in relation to the electrodes, determines how the electrical activity of these motor units affects the surface EMG signal (Basmajian & De Luca, 1985). It has been reported that muscles with homogeneous composition of fibers, such as the soleus of the cat, display a linear force-EMG relationship (Guimarães, 1994).

Figure 10 shows, as an example, an EMG signal picked up during a ramp isometric contraction (with slow growth to isometric force) in the vastus lateralis (VL), vastus medialis (VM) and rectus femoris (RF) muscles. The EMG signal shown –was passed through a third-order Butterworth filter, and band passed between 20 to 500 Hz during signal acquisition – but was otherwise unprocessed and therefore, it is called raw. The load shown in the figure refers to the external resistance applied to the leg. The signal intensity in the three muscles clearly increases with increasing external force. The questions that arise are: What is the relationship between force and EMG signal for each muscle? What treatment should be given to the EMG signal? What is the involvement of each muscle to form the resultant force? The following discussion seeks to bring some clarity to these issues.

In general, most studies involving the relationship between EMG and force aim to develop a noninvasive method to measure muscle strength during different actions. In experimental biomechanics there are different ways process of raw EMG signal and thus extract parameters related to the level of muscle contraction. Debate continues regarding the best signal processing techniques to use (Siegler et al., 1985). For example, one can find examples in the literature, in which strength has been related to the intensity, or to the median or mean frequency of the EMG signal.

Among the most used EMG parameters for such analysis, is the time series analysis, in which the the effective value of the signal, is derived from the root mean square - RMS (Basmajian & De Luca, 1985; Bigland-Ritchie, 1981; Bilodeau et al. 2003; Gerdle et al. 1991;

Gregor et al. 2002; Guimaraes et al. 1994; Herzog et al. 1998; Lawrence & De Luca, 1983; Madeleine et al., 2000; Onishi et al., 2000; Solomonow et al., 1990). This is a method to quantify the signal amplitude, recommended to assess the level of muscle activity, since the parameter is not affected by the superposition of APMU (Acierno et al., 1995; Basmajian & De Luca, 1985; De Luca, 1997). We have reported a positive correlation between this approach to parameter analysis and the strength of the quadriceps muscle in an isometric ramp task, suggesting that the coinciding increase in RMS and strength reflects two main mechanisms: the recruitment of new motor units and an increase in the frequency of active units firing (Bilodeau et al. 2003; Karlsson & Gerdle, 2001; Gerdle et al., 1991).

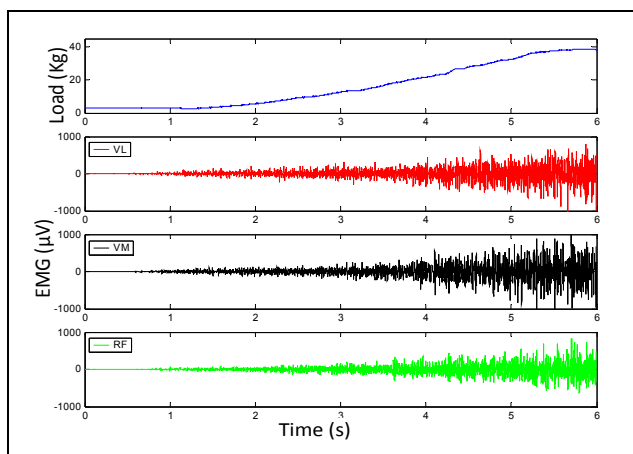

Fig. 10. EMG of the vastus medialis (VM), vastus lateralis (VL) and rectus femoris (RF) during a ramp contraction.

The normalization of the signal is a very important aspect in signal analyses displaying this relationship. A prominent feature of signal RMS is its variability, which makes it inherently difficult to compare signal amplitude across different individuals or even across different sessions within the same individual. To enable these comparisons, normalization processes are needed. The normalization process can be accomplished using a variety of reference methods. The most common example, which is standard in isometric exercises, is to express muscle contractions as a percent of the EMG amplitude observed in maximal voluntary isometric contraction (MVIC). It should however, be noted that in isotonic exercises, this process may lead to distortions, given that the muscle acts differently when changing the angular position of the limb, especially during maximal contraction. It is therefore essential to remember, that during isotonic exercise, there is an effect of changes in muscle length in electromyographic activity, as pointed out by Mohamed et al. (2002).

5. EMG x force analysis for the quadriceps

In this section we present an analysis of the EMG-force relationship for the quadriceps. This muscle is composed of four portions: rectus femoris (RF), vastus medialis (VM), vastus lateralis (VL) and vastus intermedius (VI); and the force applied to the patella is the result of the forces generated by each portion, therefore:

$$FVL+FVM+FRF+FVI=Fq \quad (10)$$

Where FVL is the force exerted by the VL, FVM is the force of VM, FRF is the force of RF, FVI is the force of VI and Fq is the resultant force of the quadriceps muscle group.

In figure 11 the forces that act on the quadriceps are illustrated. FVI is not presented because it is a deep muscle. (fig. 11.b).

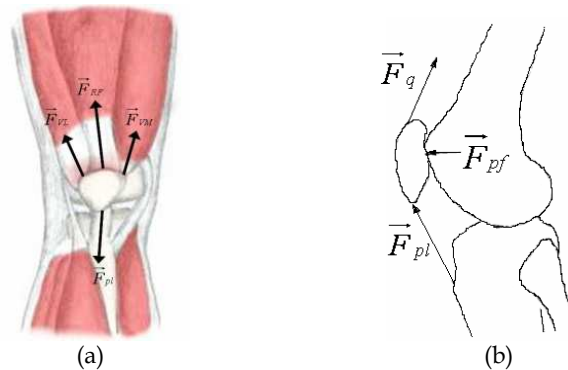

Fig. 11. a) schematic representation of the forces involved in quadriceps action. b) Forces acting on the patella, whose fixation point varies with the knee angle. Fpl is the patellar tendon force, Fq is the resultant quadriceps force and Fpf is the tibiofemoral contact force.

Each muscle's contribution is different and depends on various factors. The EMG assessed during voluntary contractions provides a way to verify differences in the activation behavior of the different quadriceps portions (Pincivero et al., 2003). Studies have demonstrated that contraction of different muscle portions contraction is dependent on the contraction intensity. During isometric contractions of low to moderate intensity, the VL recruitment is significantly higher than VM and RF; the highest activation of the VM occurs close to maximum force levels, when EMG becomes equivalent to that of the VL and RF (Pincivero et al., 2003). However, we highlight that different studies show methodological variations, so it is difficult to compare results. It should be also considered that each muscle has distinct physiological and structural properties, and these morphological characteristics are altered with changes in muscle length. Each portion can present its greater length (where the greater force is generated) at different joint angles.

The physiological and structural properties and the morphological characteristics, altered with the change in muscle length, differ for each of the agonist muscles, in this case, the four portions that make up the quadriceps muscles. Taking into account that the magnitude of the overall strength of the quadriceps is the sum of the contribution of each component muscle, we can define an α relationship between the strength modules of each muscle and the overall strength of the muscle group.

$$\alpha VL = FVL/Fq \rightarrow FVL = \alpha VL Fq \quad (11)$$

$$\alpha VM = FVM/Fq \rightarrow FVM = \alpha VM Fq \quad (12)$$

$$\alpha RF = FRF/Fq \rightarrow FRF = \alpha RF Fq \quad (13)$$

$$\alpha VI = FVI Fq \rightarrow FVI = \alpha VIFq \quad (14)$$

It can be assumed that the intensity of EMG is related to the magnitude of the force generated (F), because the EMG signal is generated regardless of the direction and sense of strength. You can also define a function β representing the relationship between EMG and F for any muscle, such as:

$$\beta(\theta, F, v, \omega) = EMG/F \quad (15)$$

Where $\beta(\theta, F, v, \omega)$ is the function that correlates EMG with the quadriceps total force. In this expression we consider the explicit dependence of β with four variables: θ , the angular position; ω , the angular displacement speed of the member, given by $w = d\theta/dt$; F , the intensity of muscle strength; and v , the velocity contraction which is related to the temporal variation of force ($v \propto dF/dt$). The dependence on these variables was noted in the previous discussions, experimental verification of the authors and the literature studies. The ability to generate muscle force depends on its length, and it varies with the angular position, justifying the dependence on θ and ω . The experimental results show that, even holding other variables constant, there is a dependence on the level of force F . It is also noted that the contraction velocity v is an important factor. The speed of contraction is related to the time necessary for the force range up to the level considered.

Based on the above discussion, it can be said that in an experimental situation in which the quantities θ , F , v and ω are known and held constant, there is a direct relationship between EMG and force given by β . Thus, for example, to the VL, we have:

$$EMG_{VL} = \beta_{VL}(\theta, F, v, \omega) F_{VL} \quad (16)$$

Substituting eq.(16) in eq.(11):

$$EMG_{VL} = \beta_{VL}(\theta, F, v, \omega) \alpha_{VL} F_{VL} \quad (17)$$

Defining the product by α per $\beta(\theta, F, v, \omega)$ as $r(\theta, F, v, \omega)$, this product represents the function that correlates the overall strength of the quadriceps with the EMG signal portion of each muscle. Thus, to the VL, we have:

$$EMG_{VL} Fq = r_{VL}(\theta, F, v, \omega) \quad (18)$$

In the same way, we can define the r_{VM} , r_{RF} and r_{VI} for the other muscles. Although already discussed, it is important to emphasize that the angle θ is the variable that depends on the initial condition of the muscle, including both length and tension. The value of the function r depends on the level of force, and this reflects recruitment strategies and types of fiber used by the muscle during low and high levels of force. Also very important are the dependencies of this function on muscle velocity and angular velocity of the limb. The first is related to the temporal variation of the force, while the second is related to the temporal variation of the angle.

5.1 Force and EMG in isometric contraction

The study of muscle strength using EMG has been applied more frequently and with greater success in isometric or in limited sectors of dynamic contractions that approximate the isometric condition (De Luca, 1997; Herzog et al. 1998 ; Lloyd & Besier, 2003).

In the particular case of isometric exercise, the function that correlates the overall strength of the quadriceps with the EMG signal can be expressed by equation 19, when the angle θ is constant and consequently $w=d\theta/dt=0$. Thus, for the VL, we have:

$$\text{EMGVLFq} = r_{\text{VL}}(\theta_{\text{cte}}, F, v) \quad (19)$$

Although θ does not vary in the isometric case, the relationship between EMG and force must be different for each angle, and depends on the level of strength and speed of contraction. It is well documented that in isometric conditions the magnitude of EMG provides a reasonable estimate of the force exerted by the muscle. Basmajian and De Luca (1985) concluded that the relationship between the intensity of EMG signal and muscle force measured during an isometric contraction has considerable inter-subject variation and, moreover, the dependence of the type of muscle is almost linear for the small muscles of the hand and non-linear for larger limb muscles - this distinction in behavior may possibly reflect the difference in the properties of firing rate and recruitment of small and large muscles, as well as other anatomical and electrical considerations, including a dependence on the level of training.

The examples showed in this text are result of an evaluation with ten female subjects with no history of pain in the knee joint, 20.4 ± 1.6 years, 51.15 ± 6.72 kg and 1.66 ± 0.05 m. For the experiment was used a leg extension chair, a system of surface EMG with Ag/AgCl electrodes placed in the bellies of the VMO, VL and RF, with a gain of 20 times, CMRR greater than 80dB and impedance of 1012Ω . Were also used a load cell type strain-gauge with a capacity of 5000N and an electrogoniometer.

Figure 12 shows a normalized EMG signal as a function of force. EMG data are normalized by the value obtained at maximal contraction and the force is normalized by the maximum

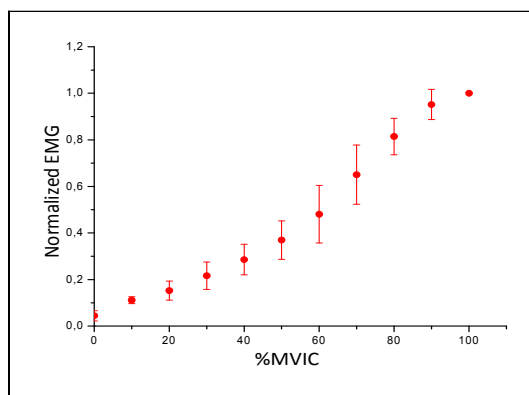

Fig. 12. Normalized EMG values of the vastus lateralis, measured isometrically in ramp at 20° of knee flexion.

force (MVIC). The illustrated values are the average of 10 subjects, and the EMG was obtained from the VL muscle. There is a positive correlation between EMG and force, as noted by Karlsson and Gerdle (2001), Gerdle et al. (1991) and Bilodeau et al. (2003). There are two regions that are clearly close to linear. A change in the slope of the force-EMG relationship is associated with a change in recruitment strategy; after full recruitment the frequency of activation is varied (Merletti & Parker, 2004).

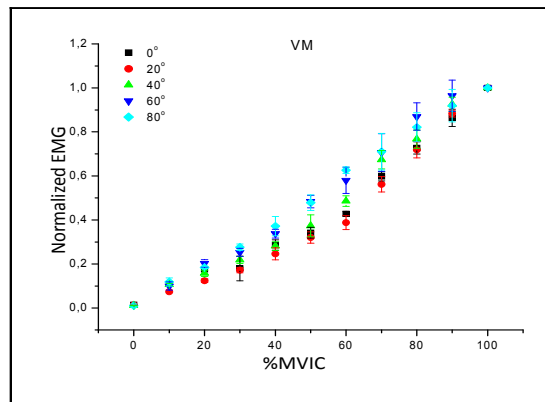

Fig. 13. Normalized EMG values of the vastus medialis, assessed isometrically in ramp at 0, 20°, 40°, 60° and 80° of knee flexion.

The same behavior is observed across different angles and muscles, but with different slopes, as shown in figure 13. In this figure, the data are for the VM muscle of a single volunteer. Although there is great variability, the dependence of the EMG values on the joint angle is clearly illustrated. This same behavior, with the same curves is observed in all subjects studied. Even in isometric exercise, keeping θ constant and $\omega=0$, and the experimental care to keep v constant, the function $r(\theta_{ct}, F, v_{ct}, \omega=0)$ which relates the force with EMG still varies with the level of strength, which in fact can be seen in figure 12.

5.2 EMG in MVIC

The maximum isometric contraction is always taken as an individual reference, especially for the normalization of EMG signals. In Figure 8, we showed that the maximum force that the individual can exert with the leg, in isometric contractions of the quadriceps, as well as the maximum force of quadriceps, varies with joint angle. Figure 14 shows the corresponding normalized EMG signal from an individual, for the three portions analyzed. It appears that the EMG signal as well as the relationship between EMG and force, when the individual generates full force, and the maximum force all change as a function of joint

angle. Therefore, the results of studies in which normalization has been performed at different angles are not easily comparable.

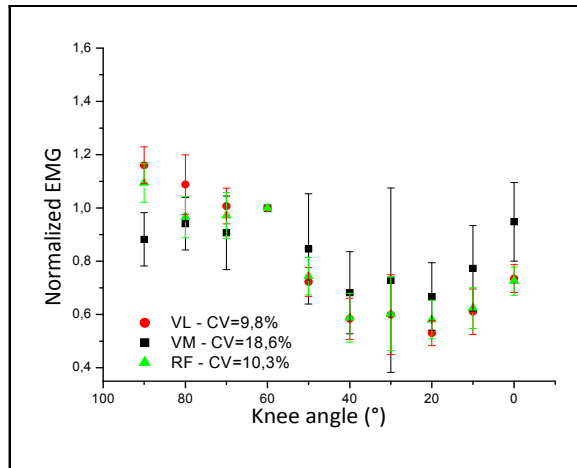

Fig. 14. EMG values during MVIC as a function of joint angle, for an individual, where VL: vastus lateralis, VM: vastus medialis and RF: rectus femoris.

5.3 Comparison of EMG with the force calculated by the model

As shown in the Hill model, even when there is an isometric contraction, there is a change in muscle length. This is important; in equation 20, it can be seen that there is a dependency between the EMG-force relationship and contraction velocity. These two aspects are equivalent, because the change in muscle length predicted by the Hill model in the isometric case, has a direct correlation with contraction velocity. The results presented in this section were all obtained at about the same rate of growth of the force ramp, i.e., at the same contraction velocity, so the function β for each angle is the same.

The graphs in figures 12 and 13 show EMG normalized according to MVIC versus isometric force normalized across the maximum force. Here we can see that force is that which was applied externally, that is, the force that the leg applies in the experimental system, rather than the quadriceps force, as shown in equation 19. Although a linear relationship is shown, this is not a causal relationship. When considering the strength of the quadriceps as the model predicts, we must also consider individual variations such as size and weight of the leg, and these may be more or less significant for the different component muscles.

The same EMG data from figures 12 and 13, when plotted as a function of the quadriceps muscle strength normalized by the maximum - as shown in Figures 15 and 16, show a change in slope, which differs from angle to angle. This is because, for the same applied force, the force that develops in the quadriceps is different for every angle, as already mentioned.

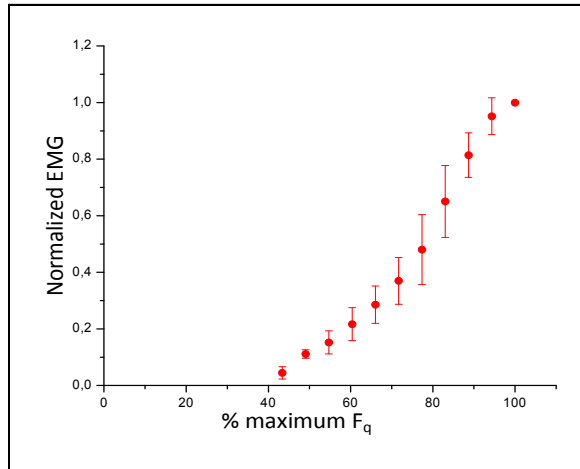

Fig. 15. Normalized EMG values of vastus lateralis in function of the percentage of quadriceps force, assessed isometrically in ramp, in 20° of knee flexion.

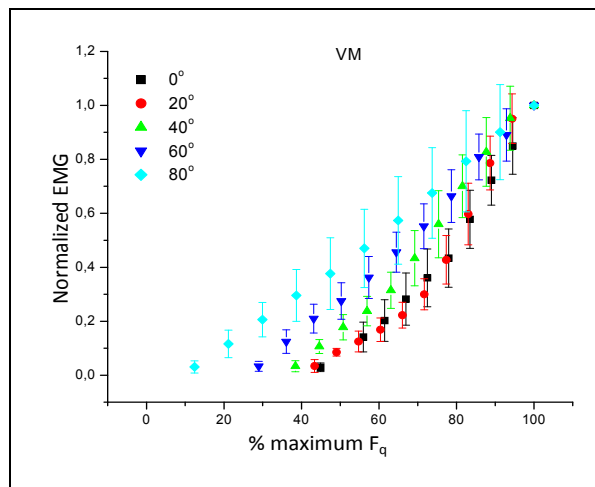

Fig. 16. Normalized EMG values of vastus medialis in function of the percentage of quadriceps force, assessed isometrically in ramp, in 0, 20°, 40°, 60° and 80° of knee flexion.

In the literature, the EMG has been compared to the applied force or torque. As in the preceding discussion, even if a coherent relationship is shown, it cannot be considered causal, because the EMG is generated by the muscle strength and is not related to the biomechanical parameters of the joint.

5.4 Isotonic contractions

In dynamic contractions, the relationship between EMG and force has a greater complexity due to experimental and physiological characteristics. A movement implies change in joint angle over which the muscle acts. Angular displacement can change the muscle geometry, and then the relative positions between the active motor units and surface electrodes may change (Basmajian & De Luca, 1985; Doorenbosch & Harlaar, 2004).

The complexity of the EMG-force relationship in an isotonic contraction can be understood through the function $r(\theta, F, v, \omega)$, where θ, F, v e ω are varied simultaneously. Therefore, to quantitatively assess the strength of isotonic contractions, in addition to the experimental care with the placement of the electrodes and movement of the skin, should be restricted to the situation that is closest to an isometric contraction. In fact, it is desirable to minimize the effect of each variable. Thus, we recommend the use of low levels of force, and control of the application of force during movement in order to limit variation in this parameter ($F \sim ct$), which is important to v exert little influence on r , and impose a lower angular velocity ($\omega \sim 0$).

6. Other instrumental tools and applications

To obtain the data presented in this chapter, the relationship between electromyography and strength in the quadriceps muscle was evaluated through conventional measures, using a differential EMG electrode placed on the skin. As discussed above, there is a limitation in these measures arising from the fact that the EMG signal recorded is the sum of action potentials occurring in the area of the electrode. Studies show that the use of electrode arrays significantly improves the ability to estimate force with EMG measures. An interesting example of such analysis can be seen in Staudenmann et al. (2006) who employed multivariate statistical analysis of principal components.

Although this chapter has discussed the measurement of muscle strength by measuring EMG, it can be said that most applications of EMG are related to some aspect of muscle force generation, because the signal is generated when muscle contractile elements are activated. In this respect, it is pertinent to mention other methods, such as: i) the use of PCA (principal component analysis) to identify the pulse trains of action potentials on a surface electromyography signal collected with multiple electrodes (Nakamura et al., 2004); ii) application of multivariate statistical techniques and multidimensional visualization in 3D space - Viz3D (Artero, 2005), to identify differences between isometric activities carried out against a rigid obstacle and with a weight of equivalent inertial load (Mello, 2007); iii) applications in studies of muscle coordination, techniques that allow, through measures of EMG, set parameters for determining the action of various muscles; and iv) studies of the relationship between force sensation and muscle stretching (Branco et al., 2006).

The magnitude of force or torque has also been compared with the spectral variables of the EMG signal (Bernardi et al., 1996; Bilodeau et al., 2003; Gerdle et al., 1991; Hermans et al., 1999; Karlsson & Gerdle, 2001; Moritani & Muro, 1987; Onishi et al., 2000). The calculation of these parameters should involve the application of appropriate techniques to obtain the power spectrum of the EMG signal. The parameters obtained in the frequency domain involves more complex procedures than those for the time domain, being the spectral distribution obtained by the fast Fourier transform or discrete Fourier transform (Bendat Piersol, 1986). Recent studies show the technique of wavelet transform as a very interesting tool for analysis in the frequency domain.

7. Conclusion

In this chapter, we have explored the relationship between EMG signals and muscle strength calculated using biomechanical models. In the literature, a common approach has been to adjust the intensity of EMG using equations derived from the Hill model. It has also been shown that the application of EMG to measure the force requires a process of calibration parameters for each individual. This process of calibration and standardization should be conducted having enough control of the variables that influence the relationship between EMG and force, as specified in equation 13.

The relationship between electrical activity and isometric muscle strength has been the focus of research since the 1950s. However, we still lack consensus regarding a precise methodology that can be widely used to quantify muscle strength based on EMG. The use of EMG as a metric for determining the force is both fascinating, and challenging. It is fascinating because of the possibilities for making a quantitative measure of strength in an individual while performing a gesture, through noninvasive surface electrodes. It is challenging in view of the complexity and variability inherent in biological signals, especially in dynamic situations. However, the application of current equipment for collecting and processing the signal remains the motivation for the use of EMG as a metric measure of force. The study of this issue, using methodologies that combine calibration processes or normalize instrumental resources, including arrays of electrodes, and signal processing using multivariate statistical techniques (PCA), can provide great advances.

8. References

- Acierno, SP; Baratta, RV; Solomonow, M. (1995). *A practical guide to electromyography for biomechanists*, Bioengineering Laboratory/LSUMC Department of Orthopaedics, Louisiana.
- Amadio, AC, Duarte M. (1996). *Fundamentos biomecânicos para análises do movimento humano*. Laboratório de Biomecânica/EEFE-USP, São Paulo.
- Amadio, AC, Barbanti, VJ. (2000). *A biodinâmica do movimento humano e suas relações interdisciplinares*, Estação Liberdade, ISBN 85-7448-019-3, São Paulo.
- Artero AO. (2005). *Estratégias para apoiar a detecção de estruturas em visualizações multidimensionais perceptualmente sobrecarregadas*, Instituto de Ciências Matemáticas e de Computação/ICMC, USP, São Carlos.
- Barbanti, VJ et al. (2002). *Esporte e atividade física: interação entre rendimento e saúde* (1), Manole, ISBN 8520413889, São Paulo.
- Basmajian, JV; De Luca, CJ. (1985). *Muscles alive: their functions revealed by electromyography* (5), Williams and Wilkins, ISBN 068300414X, Baltimore.
- Bendat, JS; Pierson, AG. (1986). Decomposition of wave-forces into linear and nonlinear components. *Journal of Sound and Vibration*, Vol.106, No.3, May.1986, pp.391-408, ISSN 0022-460X.
- Bernardi, M et al. (1996). Motor unit recruitment strategy changes with skill acquisition. *European Journal Applied Physiology*, Vol. 74, No. 1, Aug. 1996, pp. 52-59, ISSN 1439-6319.
- Bigland-Ritchie, B. (1981). EMG/force relations and fatigue of human voluntary contractions. *Exercise Sport and Science Reviews*, Vol.9, pp.75-117, ISSN 1538-3008.

- Bilodeau, M. et al. (2003). EMG frequency content changes with increasing force and during fatigue in the quadriceps femoris muscle of men and women. *Journal of Electromyography and Kinesiology*, Vol.13, No.1, Feb. 2003, pp.83-92, ISSN 1050-6411.
- Branco VR. Et al. (2006). relação entre a tensão aplicada e a sensação de desconforto nos músculos isquiotibiais durante o alongamento. *Revista Brasileira de Fisioterapia*, Vol.10, No.4, Dez.2006, pp.465-472, ISSN 1413-3555.
- De Leva, P. (1996). Adjustments to Zatsiorsky-Seluyanov's segment inertia parameters. *Journal of Biomechanics*, Vol.29, No.9, Sept. 1996, pp.1223-1230, ISSN 0021-9290.
- De Luca, CJ. (1997). The use of surface electromyography in biomechanics. *Journal of Applied Biomechanics*, Vol.13, No.2, May. 1997, pp.135-163, ISSN 1065-8483.
- Doorenbosch, CAM.; Harlaar, J. (2004). Accuracy of practicable EMG to force model for knee muscles: short communications. *Neuroscience Letters*, Vol.368, No.1, Sept. 2004, pp.78-81, ISSN 0304-3940.
- Fox, E.; Foss, ML.; Keteyian, SJ. (2000). Bases fisiológicas do exercício e do esporte (6), Guanabara-Koogan, ISBN 8527705303, Rio de Janeiro.
- Gerdle, B. et al. (1991). Dependence of the mean power frequency of the electromyogram on muscle force and fibre type. *Acta Physiologica Scandinavica*, Vol.142, No.4, Aug. 1991, pp.457-465, ISSN 0001-6772.
- Gregor, SM. et al. (2002). Lower extremity general muscle moment patterns in healthy individuals during recumbent cycling. *Clinical Biomechanics*, Vol.17, No.2, Feb. 2002, pp.123-129, ISSN 0268-0033.
- Guimarães, AC. et al. (1994). EMG-force relationship of the cat soleus muscle studied with distributed and non-periodic stimulation of ventral root filaments. *Journal of Experimental Biology*, Vol.186, No.1, Jan.1994, pp.75-93, ISSN 0022-0949.
- Hermans, V.; Spaepen, AJ.; Wouters, M. (1999). Relation between differences in electromyographic adaptations during static contractions and the muscle function. *Journal of Electromyography and Kinesiology*, Vol.9, No.4, Aug. 1999, pp.253-261, ISSN 1050-6411.
- Henneman, E.; Somjen, G.; Carpenter, DO. (1965). Functional significance of cell size in spinal motoneurons. *Journal of Neurophysiology*, Vol.28, May. 1965, pp.560-580, ISSN 0022-3077.
- Henneman, E.; Olson, CB. (1965). Relations between structure and function in the design of skeletal muscles. *Journal of Neurophysiology*, Vol.28, May. 1965, pp.581-598, ISSN 0022-3077.
- Herzog, W. et al. (1998). EMG-force relation in dynamically contracting cat plantaris muscle. *Journal of Electromyography and Kinesiology*, Vol.8, No.3, June 1998, pp.147-155, ISSN 1050-6411.
- Hof, AL.; Van Den Berg, JW. (1981). EMG to force processing I: an electrical analogue of the hill muscle model. *Journal of Biomechanics*, Vol.14, No.11, pp.747-758.
- Karlsson, S.; Gerdle, B. (2001). Mean frequency and signal amplitude of the surface EMG of the quadriceps muscles increase with increasing torque - a study using the continuous wavelet transform. *Journal of Electromyography and Kinesiology*, Vol.11, No.2, Apr. 2001, pp.131-140, ISSN 1050-6411.
- Kellis, E.; Baltzopoulos, V. (1999). The effects of the antagonist muscle force on intersegmental loading during isokinetic efforts of the knee extensors. *Journal of Biomechanics*, Vol.32, No.1, Jan. 1999, pp.19-25, ISSN 0021-9290.

- Lawrence, JH.; De Luca, CJ. (1983). Myoelectric signal versus force relationship in different human muscles. *Journal of Applied Physiology*, Vol.54, No.6, June. 1983, pp.1653-1659, ISSN. 8750-7587.
- Lippold, OCJ. (1952). The relation between integrated action potentials in a human muscle and its isometric tension. *The Journal of Physiology*, Vol. 117, pp. 492-499, ISSN 1469-7793.
- Lloyd, DG.; Besier, TF. (2003). An EMG-driven musculoskeletal model to estimate muscle forces and knee joint moments in vivo. *Journal of Biomechanics*, Vol.36, No.6, June 2003, pp.765-776, ISSN 0021-9290.
- Mohamed, O.; Perry, J.; Hislop, H. (2002). Relationship between wire EMG activity, muscle length and torque of the hamstrings. *Clinical Biomechanics*, Vol.17, No.8, Oct. 2002, pp.569-576, ISSN 0268-0033.
- Moritani, T.; Muro, M. (1987). Motor unit activity and surface electromyogram power spectrum during increasing force of contraction. *European Journal of Applied Physiology*, Vol.56, No.3, May 1987, pp.260-265, ISSN 1439-6319.
- Madeleine, P. et al. (2000). Mechanomyography and electromyography force relationships during concentric, isometric and eccentric contractions. *Journal of Electromyography and Kinesiology*, Vol.10, No.1, Feb. 2000, pp.33-45, ISSN 1050-6411.
- Mello EM. (2006). *Estudo da atividade mioelétrica em exercícios isométricos com diferentes contrações*, Programa de Pós-Graduação Interunidades Bioengenharia, USP, São Carlos.
- Merletti, R.; Knaflitz, M.; De Luca, CJ. (1990). Myoelectric manifestations of fatigue in voluntary and electrically elicited contractions. *Journal of Applied Physiology*, Vol.69, No.5, Nov. 1990, pp.1810-1820, ISSN 8750-7587.
- Nakamura H. et al. (2004). The application of independent component analysis to the multi-channel surface electromyographic signals for separation of motor unit action potential trains: part I - measuring techniques. *Journal of Electromyography and Kinesiology*, Vol.14, No.4, Aug. 2004, pp. 423-432, ISSN 1050-6411.
- Nordin, M.; Frankel, VH. (2001). *Biomecânica básica do sistema musculoesquelético* (3), Guanabara-Koogan, ISBN 852770823X, Rio de Janeiro.
- Onishi, H. et al. (2000). Relationship between EMG signals and force in human vastus lateralis muscle using multiple bipolar wire electrodes. *Journal of Electromyography and Kinesiology*, Vol.10, No.1, Feb.2000, pp.59-67, ISSN 1050-6411.
- Pincivero, DM. et al. (2003). Knee extensor torque and quadriceps femoris EMG during perceptually-guided isometric contractions. *Journal of Electromyography and Kinesiology*, Vol.13, No.2, Apr. 2003, pp.159-167, ISSN 1050-6411.
- Rash, GS. (2002). *Electromyography fundamentals*. Gait and Clinical Movement Analysis Society. Disponível em:<www.gcmas.org>. Acesso em: 17/10/05.
- Siegler, S. et al. (1985). Effect of myoelectric signal processing on the relationship between muscle force and processed EMG. *American Journal of Physical Medicine*, Vol.64, No.3, pp.130-149, ISSN 0002-9491.
- Solomonow, M. et al. (1990). The EMG-force relationship of skeletal muscle dependence on contraction rate, and motor units control strategy. *Electromyography and Clinical Neurophysiology*, Vol.30, No.3, Apr. 1986, pp.141-152, ISSN. 0301-150X.
- Staudenmann D. et al. (2006). Improving EMG-based muscle force estimation by using a high-density EMG grid and principal component analysis. *IEEE TRANSACTIONS*

ON BIOMEDICAL ENGINEERING, Vol.53, No.4, Apr. 2006, pp.712-719, ISSN 0018-9294.

Van Eijden, TMGJ. et al. (1986). A mathematical model of the patellofemoral joint. *Journal of Biomechanics*, Vol.19, No.3, pp.219-229, ISSN 0021-9290.

Whiting, WC.; Zernicke, RF. (2001). *Biomecânica da lesão muscuesquelética* (1). Guanabara-Koogan, ISBN 852770630X, Rio de Janeiro.

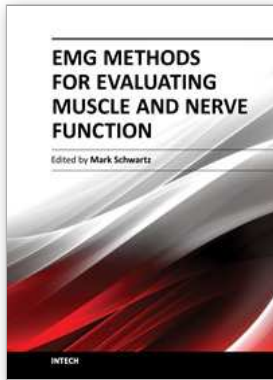

EMG Methods for Evaluating Muscle and Nerve Function

Edited by Mr. Mark Schwartz

ISBN 978-953-307-793-2

Hard cover, 532 pages

Publisher InTech

Published online 11, January, 2012

Published in print edition January, 2012

This first of two volumes on EMG (Electromyography) covers a wide range of subjects, from Principles and Methods, Signal Processing, Diagnostics, Evoked Potentials, to EMG in combination with other technologies and New Frontiers in Research and Technology. The authors vary in their approach to their subjects, from reviews of the field, to experimental studies with exciting new findings. The authors review the literature related to the use of surface electromyography (SEMG) parameters for measuring muscle function and fatigue to the limitations of different analysis and processing techniques. The final section on new frontiers in research and technology describes new applications where electromyography is employed as a means for humans to control electromechanical systems, water surface electromyography, scanning electromyography, EMG measures in orthodontic appliances, and in the ophthalmological field. These original approaches to the use of EMG measurement provide a bridge to the second volume on clinical applications of EMG.

How to reference

In order to correctly reference this scholarly work, feel free to copy and paste the following:

Heloyse Uliam Kuriki, Fábio Micolis de Azevedo, Luciana Sanae Ota Takahashi, Emanuelle Moraes Mello, Rúben de Faria Negrão Filho and Neri Alves (2012). The Relationship Between Electromyography and Muscle Force, *EMG Methods for Evaluating Muscle and Nerve Function*, Mr. Mark Schwartz (Ed.), ISBN: 978-953-307-793-2, InTech, Available from: <http://www.intechopen.com/books/emg-methods-for-evaluating-muscle-and-nerve-function/the-relationship-between-electromyography-and-muscle-force>

INTECH

open science | open minds

InTech Europe

University Campus STeP Ri
Slavka Krautzeka 83/A
51000 Rijeka, Croatia
Phone: +385 (51) 770 447
Fax: +385 (51) 686 166
www.intechopen.com

InTech China

Unit 405, Office Block, Hotel Equatorial Shanghai
No.65, Yan An Road (West), Shanghai, 200040, China
中国上海市延安西路65号上海国际贵都大饭店办公楼405单元
Phone: +86-21-62489820
Fax: +86-21-62489821

© 2012 The Author(s). Licensee IntechOpen. This is an open access article distributed under the terms of the [Creative Commons Attribution 3.0 License](#), which permits unrestricted use, distribution, and reproduction in any medium, provided the original work is properly cited.