

Research Article

The Supply Chain Financial Supervision Mechanism of the Internet of Things Based on the Integration of RFID and Wireless Sensor Network

Qingyun Zhu¹ and Ying Cai^{1,2} 

¹School of Economics and Business Administration, Yunnan Technology and Business University, Kunming, Yunnan 651700, China

²Faculty of Geography, Yunnan Normal University, Kunming, Yunnan 650500, China

Correspondence should be addressed to Ying Cai; caiying1987@user.ynnu.edu.cn

Received 22 September 2021; Revised 15 October 2021; Accepted 16 October 2021; Published 31 October 2021

Academic Editor: Guolong Shi

Copyright © 2021 Qingyun Zhu and Ying Cai. This is an open access article distributed under the Creative Commons Attribution License, which permits unrestricted use, distribution, and reproduction in any medium, provided the original work is properly cited.

Based on the fusion of wireless sensor modules and UHF RFID readers, this paper develops a UHF RFID reading and writing system based on wireless sensing technology and designs a communication interface circuit that integrates wireless sensing and RFID technology. The financial supervision mechanism of the Internet of Things compatible with these two technologies improves the communication distance limitation of the RFID system and improves the flexibility of the RFID reading and writing system. Secondly, in view of the security issues of WSN small and medium data distribution, this paper proposes a lightweight small data supply chain financial supervision program. The solution adopts two-way authentication technology based on the improvement of the Internet of Things supply chain, the negotiation of the Internet of Things supply chain, and a lightweight encryption algorithm, which realizes the secure communication between ordinary nodes and gateway nodes, and can more effectively solve the problem of small and medium data distribution in WSN to resist the deficiencies of the financial supervision mechanism; compared with existing solutions of the same magnitude, it has higher security and efficiency. Experimental simulation shows that an important problem in the converged network is the imbalance of node energy consumption. In order to reduce the negative impact of the imbalance of energy consumption on the network, this article compares the two for direct transmission protocol and minimum energy multihop routing protocol. From the perspective of supply chain process performance, based on the proposed technical impact framework, it analyzes how companies actually carry out ID application work, making the research from general to individual, from theory to practice. The network energy consumption calculation method under this protocol improves an improved network architecture model that increases the communication scale. The test results show that the technical impact analysis framework established in this article based on the theory of the Internet of Things and the advantages of RFID technology can analyze the automation benefits, information benefits, and transformative benefits brought by automatic identification technology to the supply chain and introduce complementary resources and potential factors. It provides a theoretical basis and operation method for measuring the impact of RFID on the performance of the financial supervision process based on the Internet of Things supply chain in practical applications.

1. Introduction

RFID (radio frequency identification) technology can identify the identity information of objects, and its fast and convenient communication method can save a lot of time and improve production efficiency for many production applications [1]. However, the RFID system has certain limitations in the data transmission distance, and the RFID system cannot provide

the physical environment parameters of the object. The Internet of Things is based on the Internet. Sensing devices such as RFID systems and infrared induction systems are connected through interfaces and follow protocol standards to form the “Internet of Things” for communication between things [2]. With the expansion of the Internet of Things from the field of life to the application of industrial sectors, the mechanized and electrified manufacturing industry is shifting to the

direction of intelligence [3]. In the development of the Internet of Things, the integration of wireless sensor networks and RFID technologies will expand the recognition performance of the Internet of Things at the sensor network level for “things,” realize the intelligent management of objects based on the Internet, and provide users with more services [4].

WSN (wireless sensor network) is a low-cost small network that is often used to provide environmental monitoring information, and in this network, data can be transmitted over long distances through multihop transmission [5]. The fusion of wireless sensor networks and RFID technology has attracted widespread attention at home and abroad, and corresponding fusion schemes have been proposed. The fusion methods of wireless sensor network and RFID technology based on wireless sensor technology include the fusion of RFID electronic tags and sensors, the fusion of RFID electronic tags and wireless sensor networks, and the fusion of RFID readers and wireless sensor network nodes [6–8]. Therefore, the fusion of RFID technology and wireless sensor network has been improved in function and meets the requirements of efficient, accurate, and reliable communication, which has become the development trend of the future Internet of Things technology. The Internet of Things tracks and monitors various entities through the Internet to realize the exchange of information between things. Realized in the application of financial supervision mechanism, the Internet of Things subverts traditional information collection methods, and optimizes the industrial chain of financial supervision mechanisms by monitoring and controlling the production, distribution, transportation, service, maintenance, and other processes of products [9]. Therefore, the Internet of Things requires that the objects in the network not only have a unique identification code but also need to monitor the surrounding environment information where the object is located. Starting from the performance characteristics of wireless sensor network and RFID technology, it provides new ideas for optimizing the collection of sensing layer information for the Internet of Things [10].

With the rapid development of WSN, information security has become a core issue that restricts its further development. Since sensor nodes are generally deployed in harsh environments, there are problems such as a large number of nodes, limited data processing capabilities, and limited energy, and traditional security solutions cannot be applied to wireless sensor networks. This paper focuses on the fusion of RFID network and WSN network, summarizes in detail several typical RFID and WSN network fusion methods, proposes a multimode network fusion method, and gives some related algorithms and after the fusion has done an energy consumption analysis. It provides a theoretical basis and operating methods for measuring the impact of FMCG supply chain process performance in practical applications. The innovation of this article is that with the development of the Internet of Things as the background, from the perspective of the performance of the supply chain process, based on the proposed technical impact framework, it analyzes how the financial supervision mechanism actually carries out the application work, making the research from the general to the individual, from the theory to the reality. In view of the problem of quantification of impact reflected

in the actual analysis, the article also provides methods and models to quantify the benefits of the three aspects of the supply chain. It provides a reference basis for the financial supervision mechanism to better carry out RFID applications. Finally, the RFID and WSN network are integrated with the smart reader integration method, combined with the development of the information system to realize a distributed attendance system, and the reliability of the integrated network is verified through physical testing.

2. Related Work

At the perception network layer of the Internet of Things, RFID, sensors, and other sensing devices collect information about objects. As one of the sensing devices in the perception layer of the Internet of Things, sensors are responsible for collecting object information and are the basis for the Internet of Things to realize the connection of things. In the development of wireless sensor network technology, traditional routing mechanisms cannot meet the technical requirements of wireless sensor networks, and high-cost Bluetooth and wireless local area networks are not conducive to the promotion of the technology [11]. When low-cost, low-power wireless sensor technology appears, it meets the application requirements of wireless sensor networks in the home and industrial fields, and becomes the preferred protocol for wireless sensor networks. However, wireless sensors do not have the tag recognition function of RFID technology.

Hoa and Kim [12] proposed the E-G scheme, which used the random IoT supply chain preallocation method. The main content of the E-G scheme is each sensor node first selects several IoT supply chains from the IoT supply chain pool during the preallocation stage of the IoT supply chain and then saves them in the register. When the IoT supply chain is established, the node will broadcast its key identifier to other nodes and then compare it with the IoT supply chain identifier received from neighboring nodes. If the two are the same, then we establish a secret session link. The network connectivity of this solution is not high. The IoT supply chain is selected based on probability, and the security is not high. When the node is captured by the enemy, it will threaten the security of the link. Khan et al. [13] proposed the q -composite program, which also adopted a random IoT supply chain preallocation method. In this scheme, it is necessary to ensure that two adjacent nodes must share q or more IoT supply chains before they can establish a confidential session. Although this scheme enhances the robustness of the wireless sensor network, the network connectivity is worse, and the security of WSN will decline rapidly as the number of captured nodes increases. Koot et al. [14] proposed a polynomial-based IoT supply chain management scheme, which uses polynomial symmetry to generate conversations between nodes in the IoT supply chain. This scheme requires a lot of computing power. A classic IoT supply chain management solution in WSN is the IoT supply chain management protocol, whose theoretical basis is a symmetric matrix. In this scheme, if the number of nodes captured by the attacker exceeds q , the security of the network will be threatened, and the danger of being compromised will be faced. Therefore, the security of this scheme has q -order.

Traditional RFID technology can only track the financial supervision mechanism, but cannot monitor the environment in which the items are located, cannot monitor the status of the financial supervision mechanism, and cannot reduce the probability of the financial supervision mechanism decay. Shih and Wang [15] developed a system that integrates sensors and RFID tags to estimate the possibility of bacterial growth by measuring the temperature and combining the duration of the temperature to improve the freshness of the perishable financial supervision mechanism. Antonucci et al. [16] used the fusion system of RFID and wireless sensor network to monitor the dosage of elderly people. The realization process is to combine the weight sensor with the RFID tag and stick it on the medicine bottle. The RFID reader recognizes the medicine bottle label and sends the type of medicine and the weight of the medicine to the data processing center, so as to realize the medicine for the elderly remote monitoring, promptly solve the problems of using wrong medicine, taking too much medicine, etc., and adopt appropriate methods to avoid the next occurrence, so as to improve the rationality of medication for the elderly, in the hospital, in order to ensure the safety of patients with blood [17, 18]. Some scholars integrate wireless sensor networks and RFID tags to design a management system for measuring blood temperature and tracking the location of blood packets. The system uses sensors to measure the temperature of the blood freezer, uses RFID tags to identify the blood type of the blood pack, and transmits the freezer temperature and blood type to the management center through a wireless sensor network, real-time remote monitoring of the blood storage environment, to improve the quality of blood. At the same time, through the identification of the blood type in the blood pack, the medical accident of the wrong blood transfusion to the patient is avoided [19–21].

3. The Construction of a Supply Chain Financial Supervision Mechanism Based on the Integration of RFID and Wireless Sensor Network of the Internet of Things

3.1. Hierarchical Distribution of Wireless Sensor Networks. The wireless sensor network node is composed of a sensor module, a processor module, a wireless communication module, and a power supply module. The sensor module is responsible for collecting information for the initial data processing through the analog-to-digital converter; node information storage and deep processing are completed in the processor module; the wireless communication module will receive the data for the final processing and then send it to other wireless devices through the antenna. Figure 1 shows the hierarchical structure of wireless sensor network. The operation of the entire node is based on the normal power supply of the battery.

The wireless sensor network is composed of three parts: sensor nodes, sink nodes, and management nodes. The sensor node is responsible for the collection of external data; the sink node stores, analyzes, and processes the data transmitted by the sensor node; the management node configures the network, releases monitoring tasks, collects monitoring

data, etc., and transmits the processed data to users.

$$p(x(1), x(2), \dots, x(n)) = \prod_{i=1}^n p\{x(n)|x(n-i+1)\}, \quad (1)$$

$$\frac{T^2 - 1}{n} \times \sum_{i=1}^n (p(i) - p(x))^2 = 0. \quad (2)$$

Wireless sensor technology based on the IEEE 802.15.4 standard is a standard specification for the network layer and application layer of wireless sensor networks. Wireless sensing technology realizes long-distance transmission of data through mutual cooperation between nodes. The 11-point wireless sensing terminal node can be connected to various sensor modules such as infrared sensor modules, pressure sensor modules, temperature sensor modules, and humidity sensor modules. Long-distance environmental monitoring, data collection, monitoring, and wireless network positioning are given.

$$g[w(i)|w(i-n+1), \dots, w(i-1)] = \frac{P(w(i-n+1), \dots, w(i-1), w(i))}{P(w(i-n+1), \dots, w(i-1))}. \quad (3)$$

The star topology has only one coordinator node, several terminal nodes, and router nodes, and all nodes can only communicate directly with the coordinator node. Compared with the other two topologies, the low-cost characteristics of this topology have greater advantages in practical applications.

$$X[t(i), t(j)] = \frac{u(x)}{\exp(t) - \exp(-t)} [\exp(1-t) - \exp(1+t)]. \quad (4)$$

This structure is a single-hop communication network. Compared with a multihop communication network, the information delay that occurs during information transmission is smaller. This topology saves time for the coordinator to allocate equipment to the network.

$$\exp \sum_{i=1}^n x(i)f(s, t) = \exp x(1)f(x) + \dots + \exp x(n)f(x), \quad (5)$$

$$Y(x) = \sum_{x=1, y=1}^n p(y|x) \times f(y|x). \quad (6)$$

Moreover, a coordinator node can centrally control all the terminals or router nodes that communicate directly with it, but this structure still has some shortcomings. The network structure is simple, and the coverage is limited. It is suitable for low power consumption and simple point-to-point communication occasions.

3.2. RFID System Composition. The RFID radio frequency identification system is composed of three parts: an electronic tag, a reader, and a host computer data processing system. The communication between the reader and the

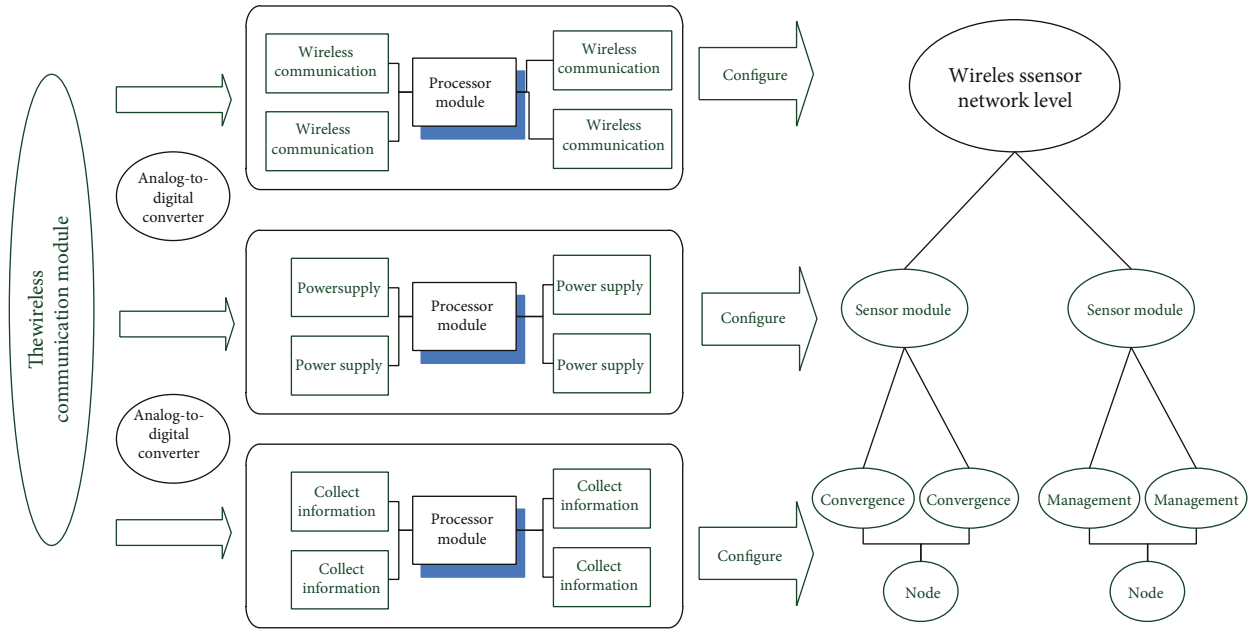

FIGURE 1: Hierarchical structure of wireless sensor network.

electronic label and the reader and the upper computer data processing system follows the “master-slave principle.” The upper computer data processing system controls the communication of the RFID system. The upper computer sends a read or write tag command to the reader through the serial port as the active party. The reader acts as the active party to execute the command and establish communication with the electronic tag. The reader is mainly composed of three parts: interface module, control module, and radio frequency module. In addition, compared with the simulation results obtained by optimization of other optimization algorithms, the energy consumption of all nodes on each ring belt of the ring network after the dual-species free search optimization is lower and relatively more even, which plays a role in extending the life cycle of the wireless sensor network critical use. The reader and the electronic tag are connected through the interface module, and the communication between them is controlled by the control module; the function of the radio frequency module is to generate radio frequency signals, and the modulated carrier wave is sent out through the antenna in the radio frequency module under the action of the control module and demodulates the electronic tag information received by the antenna. Figure 2 shows the RFID system circuit composition. For readers working in different frequency bands, the internal circuit composition of the radio frequency module is also different.

In the inductive coupling mode, the electronic tag and the reader/writer adopt a loop coil antenna. There is an LC resonant circuit inside the reader and the electronic tag. When electromagnetic oscillation occurs inside the reader, electromagnetic waves that change with time are radiated outward, and the tag antenna induction coil forms a high-frequency alternating electromagnetic field, which generates an induced voltage, which is rectified by the internal circuit of the tag as the working voltage of the passive electronic

tag. For the convenience of comparison, we can simply assume that when the retailer applies radio frequency identification tags to a single product, the efficiency of the retailer to replenish the empty shelves is $T = 100\%$, and when the radio frequency identification tags are not used, the replenishment efficiency of idle shelves is $T < 100\%$. The radio frequency module is responsible for modulating the baseband signal to the radio frequency and transmitting it through the antenna, as well as amplifying, filtering, and downconverting the signal received by the antenna to the baseband for processing. These include LNAs, filters, and adjustable amplifiers. That is, it reflects the ratio of retailer’s efficiency in replenishing vacant shelves when RFID tags are not used to the efficiency of replenishing vacant shelves after RFID tags are used. The communication distance between the passive electronic tag and the reader in the inductive coupling mode is generally tens of centimeters. The coupling method of UHF RFID reader and electronic tag is electromagnetic backscatter coupling; the communication distance between reader and electronic tag is generally about 10 meters, mainly used in supply chain management, logistics management system, aviation package management, expressway toll collection system, automatic identification of railway or highway vehicles, etc.

3.3. Layout of the IoT Supply Chain. Supply chain management is a process of managing a network connected by many organizations through logistics, capital chain, and information flow. These organizations participate in different value creation activities through the above-mentioned connections, and the internal state of the organization also affects other organizations through the above-mentioned connections. Supply chain management is an integrated management method that is applied to channel planning and control materials from suppliers to end customers. It is

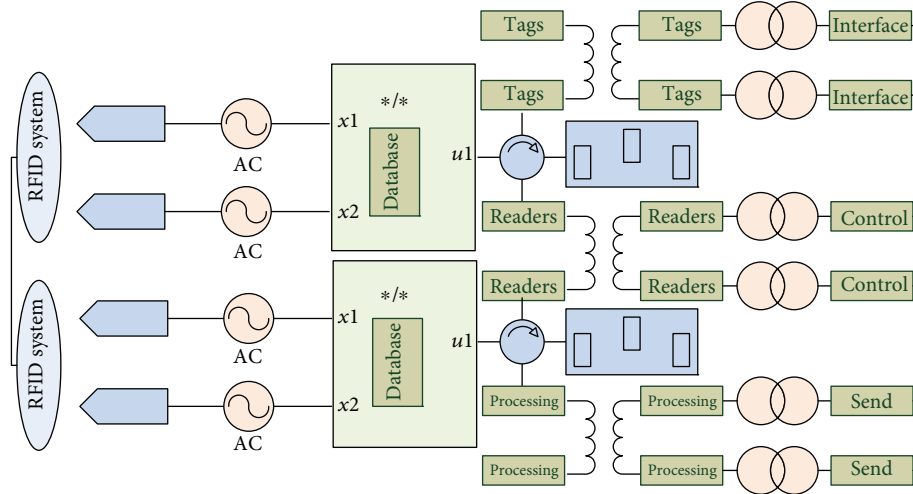

FIGURE 2: RFID system circuit composition.

guided by the interests of all members that make up the channel and through consistent joint planning and management between members. Under the goal of satisfying the customer service level of the channel, we make the most effective distribution and use of existing information, the supply chain type should be expanded to the structure of the supply network. The supply chain not only includes manufacturer’s procurement and distribution links but also should include suppliers and customers in the scope of supply chain management. Table 1 shows the description of IoT supply chain links. When the supply chain does not use radio frequency identification technology, although retailer’s demand is D , because the retailer cannot replenish the idle shelves in time, only the OD demand is actually met. Therefore, we can combine this part with demand which is regarded as effective demand.

A wireless communication network based on wireless sensor technology is established between the fusion of RFID tags and wireless sensor nodes. By setting a suitable wireless sensor network topology, the parameters such as the ambient temperature collected by the sensors and the RFID electronic tag information are read and written by RFID. Firstly, the FSDP algorithm has higher search accuracy and faster convergence speed; secondly, the FSDP algorithm can effectively avoid the algorithm from falling into the local search place during the process of optimizing the multipeak benchmark function and then obtain the global optimal solution. After the reader reads the information of the fusion node in the radio frequency range, it uploads the analyzed data to the upper computer data processing system for further analysis and processing. In the Internet of Things system, the RFID code is the unique code of a single item and is stored in the electronic tag of the item. At the same time, the Internet of Things Information Publishing Server (IoT-IS) stores the product information corresponding to the RFID code (such as name, category, production date, and shelf life). The reader reads the RFID code of the electronic tag and sends it to the Internet of Things middleware. IoT-MW sends a query instruction to the Internet of Things Name Resolution Service (IoT-NS) through the Internet. After the

IoT-NS server receives the query instruction, according to the running rules, the matching address information is found.

3.4. Update of Financial Supervision Factors. The formation of a financial supervision model requires a lot of time, resources, and energy, and its path dependence also makes its conversion cost very high. Therefore, when designing a new supply chain management model based on the Internet of Things, it should be forward-looking, by predicting the direction of future technological development and preparing relevant financial regulatory interfaces in advance. In this way, when the Internet of Things technology further develops, the adjustment level of the new management model of the supply chain based on the Internet of Things will be minimized, that is, the model is required to be scalable. It is assumed that there will be no second attempt at customer’s behavior. In other words, if customer’s first choice product is out of stock, some customers will purchase their second choice product as a substitute, if there is no shortage of their second choice product. However, if customer’s second choice is also out of stock, the customer will not make the third choice. When the commodity f is out of stock, it will produce a unit shortage penalty cost. On the contrary, the unit residual value of the remaining financial supervision efficiency is $s < t$.

Figure 3 shows the two-dimensional distribution of the weights of financial regulatory factors. The design ideas of a new supply chain management model based on the Internet of Things can be divided into prototype method and extension method according to the design method; according to the content of the design, it can be divided into system overall structure design, function design, processing flow design, database design, and user interactive interface design; according to the design steps, it can be divided into overall system design, detailed design, system implementation schedule, and plan formulation. The financial supervision serial port receiving module is responsible for the communication between the reader and the PC. It adopts the general financial supervision serial communication method. The simulation

TABLE 1: Description of IoT supply chain links.

Link number	Demand ratio	Fusion rate/%	Weights
1	0.87	88.4	0.33
2	0.69	79.1	0.16
3	0.75	83.3	0.22
4	0.79	86.4	0.29

tests in this part are aimed at the benchmark function of the low-dimensional solution space and the benchmark function of the high-dimensional solution space, using the dual population free search (FSDP) algorithm, free search (FS) algorithm, genetic algorithm (GA), and particle swarm optimization (PSO) algorithm optimized and simulated to verify the optimizing ability of various algorithms for benchmark functions of different dimensions. The module mainly receives and analyzes the commands issued by the PC and analyzes and executes different commands. When data arrives, that is, the PC sends a command to the reader, the serial port module will generate a serial port interrupt and notify the MCU to parse the command. If it is a valid command, it will be executed, and invalid commands will be discarded. The results show that by integrating information about inventory inaccuracies, the expected profit of financial supervision will be higher than when the inventory loss problem is not recognized. Since the integration of inventory inaccuracy information does not require additional costs, this provides a more appropriate benchmark for measuring the value of radio frequency identification. In addition, although we know that the optimal expected profit of financial regulation will be improved when there are alternative products or after integrating inventory inaccuracy information.

4. Application and Analysis of the Supply Chain Financial Supervision Mechanism Based on the Integration of RFID and Wireless Sensor Network

4.1. RFID Information Collection. In order to reduce the energy consumption burden of the router node closest to the coordinator node, this section discusses a method of balancing the energy consumption of the system under this network architecture through a two-tier network architecture: in a network that uses a direct transmission protocol, a terminal node with a routing and forwarding function is added between the terminal nodes closest to the coordinator node, and the energy consumption of the terminal node is reduced by sharing the amount of data transmitted by other terminal nodes to the terminal node. The parameter setting is that the input layer contains 2 nodes, the hidden layer contains 20 nodes, and the output layer is 1 node. The other parameter settings are learning rate factor is 0.002, training times $N = 50,000$; its kernel function adopts radial basis kernel function. It can be seen that, except for one data point, the training error of other data points is basically 0; compared to network training, the regression effect of the model is obtained after training, and there is basically a large

data point at each data point. The training error is even close to 26%. Therefore, the prediction model established in this paper using a given limited sample has much better recognition ability than the model established by neural network.

By controlling the inventory loss rate to be equal to 0.02, 0.05, 0.1, and 0.2, we get the situation that the profit loss changes with the change of the product substitution ratio T under the above four conditions. Figure 4 shows the line graph of the training error of the wireless sensor network model. When the product inventory loss rate is very small, retailer's profit loss decreases as the product replacement ratio T increases, and when the product inventory loss rate increases, retailer's profit loss follows the product replacement ratio T to show a "U" shape relation. This shows that product substitution has two effects on retailer's profit in the case of inventory loss. On the one hand, replacement products can partially alleviate the stock-out problem caused by inventory loss, which is reflected in the decrease in profit loss as the product replacement ratio increases; on the other hand, because only part of the stock-out problem can be alleviated by the replacement product, as the product substitution ratio increases, retailer's effective demand and optimal expected profit also increase. Therefore, when the inventory loss rate is large, compared with a lower product substitution level, the inventory loss will cause more damage of profits.

4.2. Wireless Sensor Network Transmission Simulation. The wireless sensor coordinator node communicates with the host computer through a serial port. The host computer is at RS-232 level, while the wireless sensor coordinator node uses TTL level. The incompatibility of levels makes the two unable to communicate directly. This design uses the USB to serial chip CH340G to realize the level conversion between the host computer and the wireless sensor coordinator. The CH340G chip is connected to a 12MHZ crystal oscillator, the VCC pin of the chip is connected to a 5V power supply, and the serial port pins of the CH340G chip are RXD and TXD to connect with wireless sensor coordinator. Perception of usefulness, ease of use, behavioral intentions, support from senior management, information system infrastructure, financial resources, mandatory pressure, formalization pressure, imitating competitiveness, mutual trust between organizations, and customer privacy are paid attention to the principal component factor analysis of actual signals and extract 9 common factors in total. The eigenvalues of the factors are all greater than 1, and the explained variance reaches 72.127%. Figure 5 shows the line graph of wireless sensor network connectivity ratio comparison.

For the nodes in the area, any node can establish a conversational IoT supply chain by exchanging the node identification symbol ID with neighboring nodes to realize secure communication. Therefore, any node in the area can establish a session for secure communication, that is, the connectivity is 1. For interregional communication is established between cluster head nodes, a security gateway node is introduced as the root CA to perform certificate and IoT supply chain management on gateway nodes and cluster head nodes. Before the cluster head node communicates, it needs to conduct two-way authentication and negotiation of the IoT supply chain. The

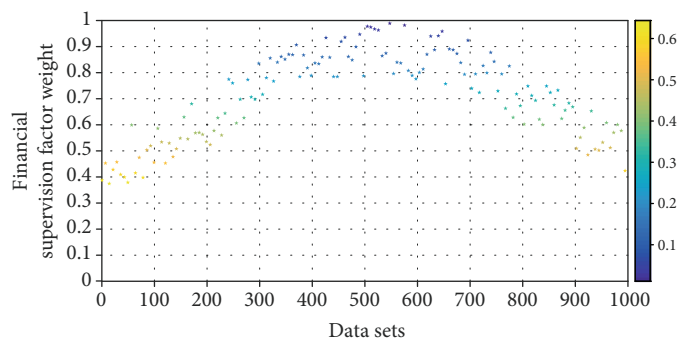

FIGURE 3: Two-dimensional distribution of the weights of financial regulatory factors.

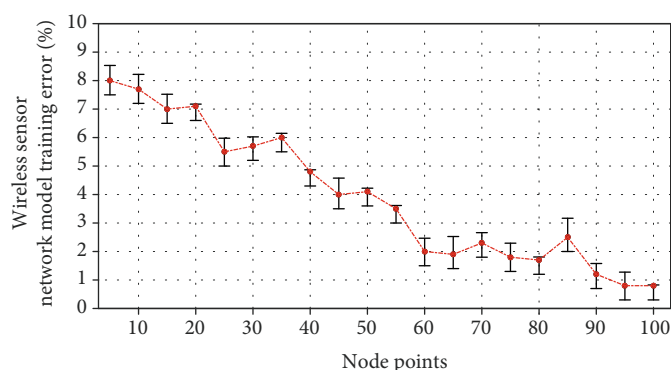

FIGURE 4: The line graph of the training error of the wireless sensor network model.

label can automatically record the movement and status of the product between the store warehouse and the in-store temporary storage area and replenish the shelf in time, thereby improving the availability of the product. Therefore, a session can be established between any cluster heads for secure communication, and the connectivity is 1. It can be seen that in this scheme, as long as the number of neighboring sensor nodes is not zero, the network connection rate is 100%. For the E-G scheme, the network connection rate can reach 100% when the number of adjacent nodes must reach 14 or more. The network connectivity of the q -composite scheme is worse. The number of neighbor nodes of a node must reach 16 or more, and the network connectivity rate can reach 100%.

4.3. Example Application and Analysis. The wireless sensor router node mainly includes radio frequency modules: wireless sensor module A, wireless sensor module B, and control module. The chip of the router node control module adopts STC12C5A60S2_DIP40, the chip VCC is connected with an external 5 V power supply, and the wireless sensor module A and wireless sensor module B are connected to the pins P30, P31 and P12, P13 of the STC12C5A60S2_DIP40 chip, respectively. The radio frequency module realizes the function of sending and receiving radio frequency signals. The wireless sensor module A receives the instructions sent by the wireless sensor coordinator node antenna and at the same time transmits the data received by the wireless sensor router node to the wireless sensor coordinator node through the antenna. The

sensor module B sends out the signal of the wireless sensor router node and at the same time receives the data from the wireless sensor terminal node.

Under the different compensation strategies for the difference in financial supervision efficiency, the relationship between the service level and the absolute value of the mean value of the difference in financial supervision efficiency is as written. Figure 6 shows the distribution of supply chain financial supervision efficiency curve. If the mean value of the difference in financial supervision efficiency is increased, the level of out-of-stock will increase without compensation measures. If the difference between the actual financial supervision efficiency and the system financial supervision efficiency is 10 units, the service level will drop from 97.5% to 83.7%. Compensating for the mean and standard deviation of financial regulatory efficiency differences keeps the service level at 97.5% of the established service level. Using the strategy of compensating for the mean difference can offset most of the decline in service levels due to differences, but the service level still drops by 0.4%. The smaller the order batch is, the more obvious the impact on the service level is. Small batches mean an increase in the frequency of placing orders, and the average financial supervision efficiency will correspondingly decrease. In the case of inventory differences, if there is no compensation strategy applied, the service level will be greatly reduced; the use of financial supervision efficiency difference mean compensation strategy can help improve the service level, but the performance in the case of

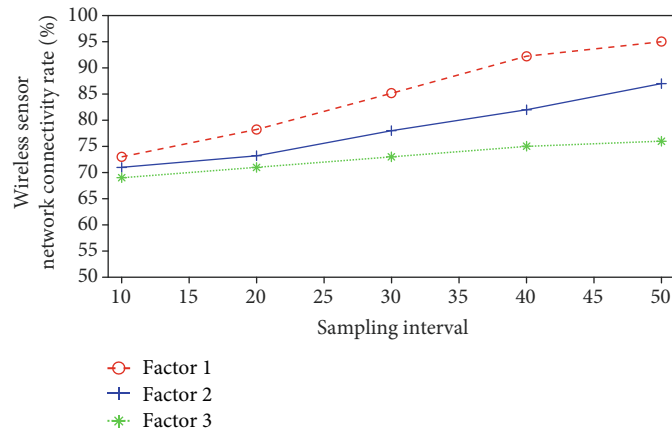

FIGURE 5: Line graph of wireless sensor network connectivity ratio comparison.

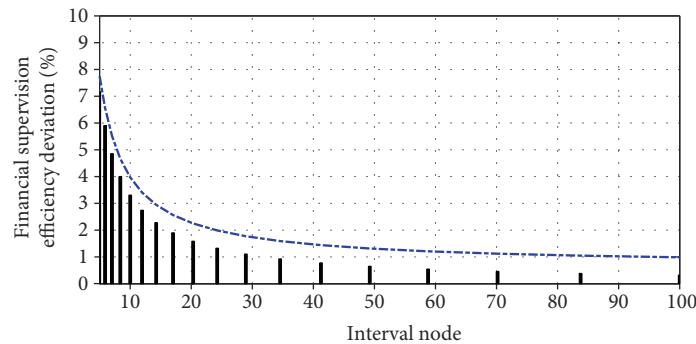

FIGURE 6: The distribution of supply chain financial supervision efficiency curve.

small batch orders is not as good as the performance of large batch orders. For example, the service level is 95.8% at the time of sound 5, and the service level rises to 97.1% when the sound is 50; the average and standard deviation compensation strategy of financial supervision efficiency is adopted, and the service level is basically maintained at a constant level.

Figure 7 shows the reliability check box diagram of the efficiency of financial supervision. Before testing the hypothesis, the reliability and validity of the scale must be tested. In this paper, Cronbach's coefficient is used as the reference index for reliability test, and factor analysis is used to test the convergence validity and discriminative validity of the scale. The Cronbach's coefficient of each dimension of the scale is calculated by using SPSS 15.0. It is generally believed that the Q coefficient greater than 0.7 indicates higher reliability, and in the case of a small number of measured variables, Cronbach's coefficient reaches 0. Above 5 is considered acceptable. With the exception of "financial resources" and "interorganizational mutual trust" because there are only two measurement variables, the coefficient is lower than 0.7 but greater than 0.5, and the coefficients of other dimensions are far greater than 0.7. It shows that the measurement indicators of latent variables have reliable internal consistency. In the case of applying barcode technology and using cargo boxes as the operating unit, distinguishing the store warehouse from the in-store temporary

storage area for shelf replenishment management will incur high costs, while the use of cargo box-level RFID with lower marginal cost. The industries that currently adopt the most RFID technology are manufacturing, logistics, warehousing and postal services, and construction, and the adoption ratios are 50.72% and 62%, respectively. Country's current wholesale and retail industries adopt RFID technology in a relatively small proportion, only 38.10%.

The result of factor analysis shows that the scale has good convergent validity and discriminative validity. In addition, before the factor analysis, the BanIeR sphericity test and the quantity test values were 0.000 and 0.815, indicating that the observed variables are suitable for factor analysis. Figure 8 shows the histogram of the proportion of radio frequency identification technology used. From the perspective of the scale of the use of radio frequency technology, the proportion of financial supervision mechanisms that adopt radio frequency identification technology on a large scale in the manufacturing, construction, and wholesale and retail industries are 17.39%, 14.29%, and 19.05%, respectively, at a relatively leading level. It is particularly worth noting that although the overall adoption level in the wholesale and retail industry is only 38.10%, the proportion of large-scale adoption of radio frequency identification technology has already accounted for 19.05%, indicating that in the wholesale and retail industry, companies have large differences

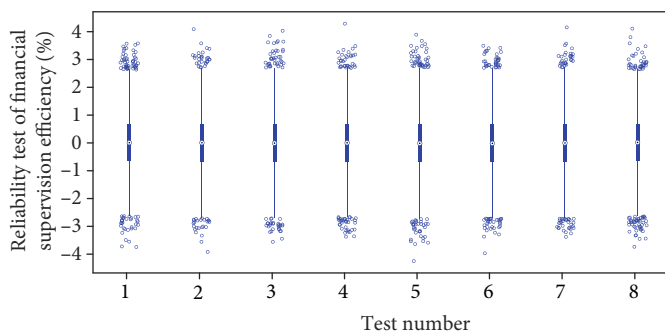

FIGURE 7: Reliability check box diagram of the efficiency of financial supervision.

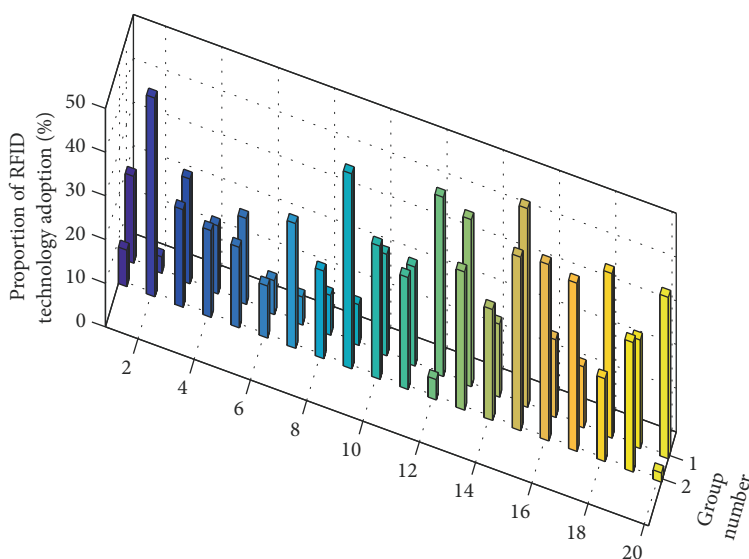

FIGURE 8: Histogram of the proportion of radio frequency identification technology used.

and gaps in the use of this technology. A few large-scale financial regulatory mechanisms have already used this technology on a large scale, but most financial regulatory mechanisms have not yet adopted it, or are only in the stage of small-scale adoption.

5. Conclusion

This article uses NET technology; the MFC framework in SQL server to develops a wireless RFID reading and writing system software based on wireless sensor technology and designs two technology-compatible financial supervision mechanisms, through the use of wireless sensor technology and RFID technology to study the theory of these two technologies, to understand the working principles of these two technologies and the relationship between them. And through the design of communication interfaces and financial supervision mechanisms, a wireless RFID reading and writing system based on wireless sensor technology is proposed to achieve the integration of wireless sensing and RFID technology at the hardware and software levels. Aiming at the problem of IoT supply chain management in WSN, on the premise that the system

has an intrusion detection function, an IoT supply chain management scheme based on subregional management is proposed. This scheme divides the WSN into a number of nonoverlapping hexagonal network areas, each of which has a cluster head node and a number of ordinary sensor nodes. Through academic literature and company consulting reports and based on the technical impact analysis framework, the article analyzes how FMCG companies develop RFID applications in practice and finally quantifies the benefits in three aspects. The required experimental data is collected through the constructed experimental platform, and then, the support vector machine algorithm is used to train the sample data, obtain a prediction model of the field strength distribution of the RFID reader through the training of the sample data, and realize the prediction of the field strength distribution of the RFID reader through the obtained prediction model. The nodes in the region use the matrix to generate the core IoT supply chain, and the conversational IoT supply chain between regions is established through the cluster head node. The security gateway distributes the security certificate to the cluster head node and the gateway node to perform the cluster head node and the gateway node with certificate management

and IoT supply chain management. Comparing this solution with the same-level solution, its security and efficiency are higher, and the network connectivity is better.

Data Availability

The data used to support the findings of this study are available from the corresponding author upon request.

Conflicts of Interest

We declare that there is no conflict of interest.

References

- [1] S. Idwan, J. A. Zubairi, and I. Mahmood, "Smart solutions for smart cities: using wireless sensor network for smart dumpster management," in *2016 International Conference on Collaboration Technologies and Systems (CTS)*, pp. 493–497, Orlando, FL, USA, October–November 2016.
- [2] J. Zhang, S. Zhong, T. Wang, H.-C. Chao, and J. Wang, "Blockchain-based systems and applications: a survey," *Journal of Internet Technology*, vol. 21, no. 1, pp. 12–14, 2020.
- [3] A. E. Guerrero-Sanchez, E. A. Rivas-Araiza, J. L. Gonzalez-Cordoba, M. Toledano-Ayala, and A. Takacs, "Blockchain mechanism and symmetric encryption in a wireless sensor network," *Sensors*, vol. 20, no. 10, p. 2798, 2020.
- [4] H. Ping, J. Wang, Z. Ma, and Y. du, "Mini-review of application of IoT technology in monitoring agricultural products quality and safety," *International Journal of Agricultural and Biological Engineering*, vol. 11, no. 5, pp. 35–45, 2018.
- [5] A. Rejeb, J. G. Keogh, and H. Treiblmaier, "Leveraging the internet of things and blockchain technology in supply chain management," *Future Internet*, vol. 11, no. 7, p. 161, 2019.
- [6] T. M. Fernández-Caramés, O. Blanco-Novoa, I. Froiz-Míguez, and P. Fraga-Lamas, "Towards an autonomous industry 4.0 warehouse: a UAV and blockchain-based system for inventory and traceability applications in big data-driven supply chain management," *Sensors*, vol. 19, no. 10, p. 2394, 2019.
- [7] A. Mallik, S. A. Hossain, A. B. Karim, and S. M. Hasan, "Development of LOCAL-IP based environmental condition monitoring using wireless sensor network," *International Journal of Sensors Wireless Communications and Control*, vol. 9, no. 4, pp. 454–461, 2019.
- [8] A. Kamilaris, A. Fonts, and F. X. Prenafeta-Boldó, "The rise of blockchain technology in agriculture and food supply chains," *Trends in Food Science & Technology*, vol. 91, pp. 640–652, 2019.
- [9] J. Duan, C. Zhang, Y. Gong, S. Brown, and Z. Li, "A content-analysis based literature review in blockchain adoption within food supply chain," *International Journal of Environmental Research and Public Health*, vol. 17, no. 5, p. 1784, 2020.
- [10] R. Wang, C. Yu, and J. Wang, "Construction of supply chain financial risk management mode based on Internet of Things," *IEEE Access*, vol. 7, pp. 110323–110332, 2019.
- [11] P. Dutta, T. M. Choi, S. Somani, and R. Butala, "Blockchain technology in supply chain operations: applications, challenges and research opportunities," *Transportation Research Part E: Logistics and Transportation Review*, vol. 142, article 102067, 2020.
- [12] T. D. Hoa and D. S. Kim, "On exploiting wireless sensor networks for enhancing the logistics operation efficiency in the Physical Internet," in *2018 2nd International Conference on Recent Advances in Signal Processing, Telecommunications & Computing (SigTelCom)*, pp. 236–240, Ho Chi Minh City, Vietnam, January 2018.
- [13] M. N. R. Khan, H. Haque, K. Labeeb, M. Aktar, R. K. Datta, and M. Z. Abedin, "Internet of things and wireless sensor network solution in smart environmental monitoring," in *2021 6th International Conference on Communication and Electronics Systems (ICCES)*, pp. 4–5, Coimbatre, India, July 2021.
- [14] M. Koot, M. R. K. Mes, and M. E. Iacob, "A systematic literature review of supply chain decision making supported by the Internet of Things and Big Data Analytics," *Computers and Industrial Engineering*, vol. 154, article 107076, 2021.
- [15] C. W. Shih and C. H. Wang, "Integrating wireless sensor networks with statistical quality control to develop a cold chain system in food industries," *Computer Standards & Interfaces*, vol. 45, pp. 62–78, 2016.
- [16] F. Antonucci, S. Figorilli, C. Costa, F. Pallottino, L. Raso, and P. Menesatti, "A review on blockchain applications in the agri-food sector," *Journal of the Science of Food and Agriculture*, vol. 99, no. 14, pp. 6129–6138, 2019.
- [17] C. Garrido-Hidalgo, F. J. Ramirez, T. Olivares, and L. Roda-Sanchez, "The adoption of internet of things in a circular supply chain framework for the recovery of WEEE: the case of lithium-ion electric vehicle battery packs," *Waste Management*, vol. 103, pp. 32–44, 2020.
- [18] M. A. Rejeb, S. Simske, K. Rejeb, H. Treiblmaier, and S. Zailani, "Internet of Things research in supply chain management and logistics: a bibliometric analysis," *Internet of Things*, vol. 12, article 100318, 2020.
- [19] J. Lu, L. Feng, J. Yang, M. M. Hassan, A. Alelaiwi, and I. Humar, "Artificial agent: the fusion of artificial intelligence and a mobile agent for energy-efficient traffic control in wireless sensor networks," *Future Generation Computer Systems*, vol. 95, pp. 45–51, 2019.
- [20] M. S. Al-Rakhami and M. Al-Mashari, "A blockchain-based trust model for the internet of things supply chain management," *Sensors*, vol. 21, no. 5, p. 1759, 2021.
- [21] K. Nellore and G. P. Hancke, "A survey on urban traffic management system using wireless sensor networks," *Sensors*, vol. 16, no. 2, p. 157, 2016.