

The Use of Spectrophotometry UV-Vis for the Study of Porphyrins

Rita Giovannetti

*University of Camerino, Chemistry Section of School of Environmental Sciences, Camerino
Italy*

1. Introduction

The porphyrins (Fig. 1) are an important class of naturally occurring macrocyclic compounds found in biological compounds that play a very important role in the metabolism of living organisms. They have a universal biological distribution and were involved in the oldest metabolic phenomena on earth. Some of the best examples are the iron-containing porphyrins found as heme (of haemoglobin) and the magnesium-containing reduced porphyrin (or chlorine) found in chlorophyll. Without porphyrins and their relative compounds, life as we know it would be impossible and therefore the knowledge of these systems and their excited states is essential in understanding a wide variety of biological processes, including oxygen binding, electron transfer, catalysis, and the initial photochemical step in photosynthesis.

The word porphyrin is derived from the Greek porphura meaning purple. They are in fact a large class of deeply coloured pigment, of natural or synthetic origin, having in common a substituted aromatic macrocycle ring and consists of four pyrrole rings linked by four methine bridges (Milgrom, 1997; D. Dolphin, 1978).

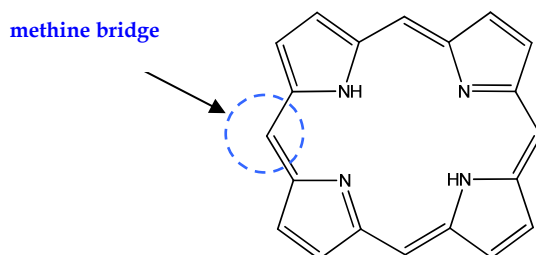

Fig. 1. The structure of porphyrin.

The porphyrins have attracted considerable attention because are ubiquitous in natural systems and have prospective applications in mimicking enzymes, catalytic reactions, photodynamic therapy, molecular electronic devices and conversion of solar energy. In particular, numerous porphyrins based artificial light-harvesting antennae, and donor acceptor dyads and triads have been prepared and tested to improve our understanding of the photochemical aspect of natural photosynthesis.

The porphyrins play important roles in the nature, due to their special absorption, emission, charge transfer and complexing properties as a result of their characteristic ring structure of conjugated double bonds (Rest et al., 1982).

As to their electronic absorption, they display extreme intense bands, the so-called Soret or B-bands in the 380–500 nm range with molar extinction coefficients of $10^5 \text{ M}^{-1} \text{ cm}^{-1}$. Moreover, at longer wavelengths, in the 500–750-nm range, their spectra contain a set of weaker, but still considerably intense Q bands with molar extinction coefficients of $10^4 \text{ M}^{-1} \text{ cm}^{-1}$. Thus, their absorption bands significantly overlap with the emission spectrum of the solar radiation reaching the biosphere, resulting in efficient tools for conversion of radiation to chemical energy. In such a conversion, the favourable emission and energy transfer properties of porphyrin derivatives are indispensable as in the case of chlorophylls, which contain magnesium ion in the core of the macrocycle. Also, metalloporphyrins can be utilized in artificial photosynthetic systems, modelling the most important function of the green plants (Harriman et al., 1996).

The studies of the wavelength shift of their adsorption band and the absorbance changes as function of pH, temperature, solvent change, reaction with metal ions and other parameters permits to obtain accurate information about equilibrium, complexation, kinetic and aggregation of porphyrins.

This review, resumes the best successes in the use of spectrophotometer UV-Vis for explained the chemical characteristics of this extraordinary group of natural occurring molecules and clarifies the potential of these molecules in many fields of application.

2. The chemical characteristics of porphyrins

The synthetic world of porphyrins is extremely rich and its history began in the middle of 1930s. An enormous number of synthetic procedures have been reported until now, and the reason can be easily understood analysing the porphyrin skeleton. In principle, there are many chemical strategies to synthesized porphyrins, involving different building blocks, like pyrroles, aldehydes, dipyrromethanes, dipyrromethenes, tripyrranes and linear tetrapyrroles.

The most famous monopyrrole polymerization route to obtain porphyrins involves the synthesis of tetraphenyl porphyrins, from reaction between pyrrole and benzaldehyde (Atwood et al., 1996). This procedure was first developed by Rothmund (Rothmund, 1935) and, after modification by Adler, Longo and colleagues (Adler et al., 1967), was finally optimized by Lindsey's group (Lindsey et al., 1987). In the Rothmund and Adler/Longo methodology the crude product contains between 5 and 10% of a byproduct, discovered later to be the *meso*-tetraphenylchlorin which is converted in the product under oxidative conditions (Fig. 2).

Rothmund in 1935 set up the synthesis of porphyrins in one step by reaction of benzaldehyde and pyrrole in pyridine in a sealed flask at 150 °C for 24 h but the yields were low, and the experimental conditions so severe that few benzaldehydes could be converted to the corresponding substituted porphyrin (Rothmund, 1936; Menotti, 1941). The reason in the low yield is that the main by-product of reaction was *meso*-substituted chlorin and in understanding the nature of its formation, Calvin and coworkers (Calvin et al., 1946)

discovered that the addition of metal salts to the reaction mixture, such as zinc acetate, increases the yield of porphyrin from 4-5% for the free-base derivative, and decreases the amount of chlorin compound. Others improvement were obtained by changing opportunely the reaction conditions and substituents in benzaldehyde molecule framework.

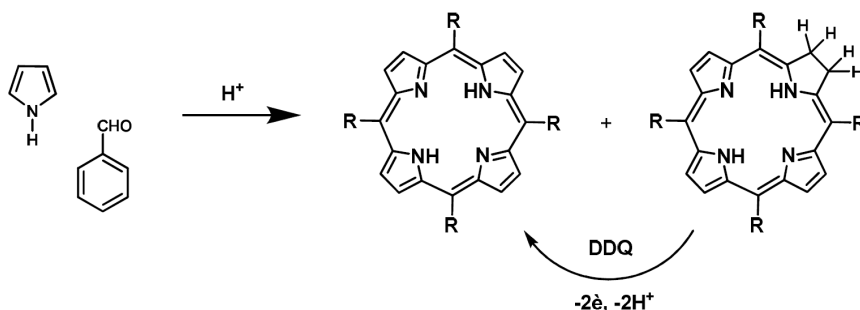

Fig. 2. Synthesis of 5,10,15,20-tetraphenyl porphyrin.

Adler, Longo and coworkers, in the 1960s (Adler et al. 1967), re-examined the synthesis of *meso*-substituted porphyrins and developed an alternative approach (Fig. 3) with a method that involves an acid catalyzed pyrrole aldehyde condensation in glassware open to the atmosphere in the presence of air. The reactions were carried out at high temperature, in different solvents and concentrations range of reactants with a yields of 30-40%, and with chlorin contamination lower than that obtained with the Rothmund synthesis.

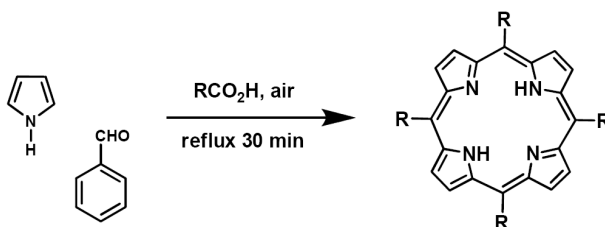

Fig. 3. Adler-Longo method for preparing *meso*-substituted porphyrins.

Over the period 1979-1986, Lindsey developed a new and innovative two-step room temperature method to synthesize porphyrins, motivated by the need for more gentle conditions for the condensation of aldehydes and pyrrole, in order to enlarge the number of the aldehydes utilizable and then the porphyrins available (Anderson et al., 1990; Acheson et al., 1976; Dailey, 1990; Porra, 1997; Mauzarall, 1960). The method has been a new strategy for the synthesis of porphyrins, using a sequential process of condensation and oxidation steps. The reactions were carried out under mild conditions in an attempt to achieve equilibrium during condensation, and to avoid side reactions in all steps of the porphyrin-forming process (Fig. 4)

The porphyrin macrocycle is a highly-conjugated molecule containing 22 π -electrons, but only 18 of them are delocalized according to the Hückel's rule of aromaticity ($4n+2$ delocalized π -electrons, where $n = 4$).

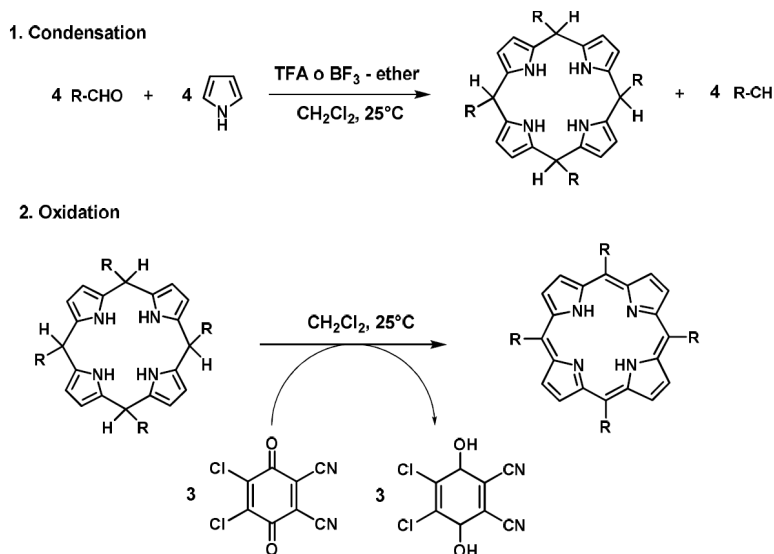

Fig. 4. Two-step one-flask room-temperature synthesis of porphyrins.

Its structure supports a highly stable configuration of single and double bonds with aromatic characteristics that permit the electrophilic substitution reactions typical of aromatic compounds such as halogenation, nitration, sulphonation, acylation, deuteration, formylation. Although this, in the porphyrins there are two different sites on the macrocycle where electrophilic substitution can take place with different reactivity (Milgrom, 1997): positions 5, 10, 15 e 20, called *meso* and positions 2, 3, 7, 8, 12, 13, 17 and 18, called β -pyrrole positions (Fig. 5). The first kind of compounds are widely present in natural products, while the second have no counterpart in nature and were developed as functional artificial models. The activation of these sites depends of the porphyrins electronegativity that can be controlled by the choice of the metal to coordinate to the central nitrogen atoms. For this, the introduction of divalent central metals produces electronegative porphyrin ligands and these complexes can be substituted on their *meso*-carbon. On the other hand, metal ions in electrophilic oxidation states (e.g. Sn IV) tend to deactivate the *meso*-position and activate the β pyrrole to electrophilic attack. The chemical characteristics of substituents in β -pyrrole and *meso*-position determine the water or solvent solubility of porphyrins.

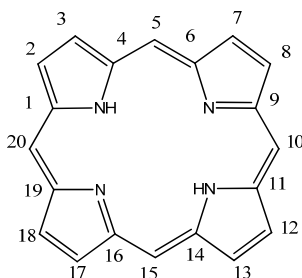

Fig. 5. Porphyrin numeration.

3. Uv-vis spectra of porphyrins

It was recognized early that the intensity and colour of porphyrins are derived from the highly conjugated π -electron systems and the most fascinating feature of porphyrins is their characteristic UV-visible spectra that consist of two distinct regions: in the near ultraviolet and in the visible region (Fig. 6).

It has been well documented that changes in the conjugation pathway and symmetry of a porphyrin can affect its UV/Vis absorption spectrum (Gouterman, 1961; Whitten et al. 1968; Smith, 1976; Dolphin, 1978; Nappa & Valentine, 1978; Wang et al. 1984; Rubio et al. 1999).

The absorption spectrum of porphyrins has long been understood in terms of the highly successful "four-orbital" (two highest occupied π orbitals and two lowest unoccupied π^* orbitals) model first applied in 1959 by Martin Gouterman that has discussed the importance of charge localization on electronic spectroscopic properties and has proposed the four-orbital model in the 1960s to explain the absorption spectra of porphyrins (Gouterman, 1959; Gouterman, 1961).

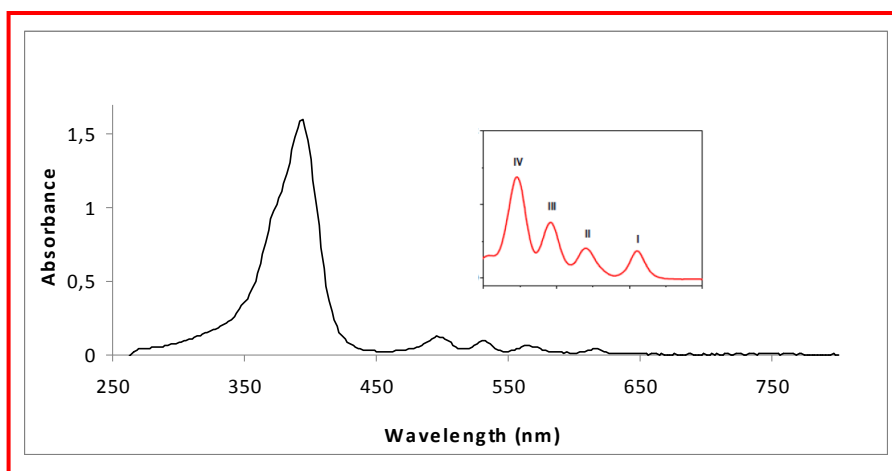

Fig. 6. UV-vis spectrum of porphyrin with in insert the enlargement of Q region between 480-720 nm.

According to this theory, as reported in Figure 7, the absorption bands in porphyrin systems arise from transitions between two HOMOs and two LUMOs, and it is the identities of the metal center and the substituents on the ring that affect the relative energies of these transitions. The HOMOs were calculated to be an a_{1u} and an a_{2u} orbital, while the LUMOs were calculated to be a degenerate set of e_g orbitals. Transitions between these orbitals gave rise to two excited states. Orbital mixing splits these two states in energy, creating a higher energy state with greater oscillator strength, giving rise to the Soret band, and a lower energy state with less oscillator strength, giving rise to the Q-bands.

The electronic absorption spectrum of a typical porphyrin (Fig. 6) consists therefore of two distinct regions. The first involve the transition from the ground state to the second excited state ($S_0 \rightarrow S_2$) and the corresponding band is called the Soret or B band. The range of

absorption is between 380-500 nm depending on whether the porphyrin is β - or *meso*-substituted. The second region consists of a weak transition to the first excited state ($S_0 \rightarrow S_1$) in the range between 500-750 nm (the Q bands). These favourable spectroscopic features of porphyrins are due to the conjugation of 18 π - electrons and provide the advantage of easy and precise monitoring of guest-binding processes by UV-visible spectroscopic methods (Yang et al. 2002; Gulino et al., 2005; Di Natale et al. 2000; Paolesse & D'Amico, 2007) CD, (Scolaro et al. 2004; Balaz et al., 2005) fluorescence, (Zhang et al., 2004; Zhou et al., 2006) and NMR spectroscopy (Shundo et al., 2009; Tong et al., 1999).

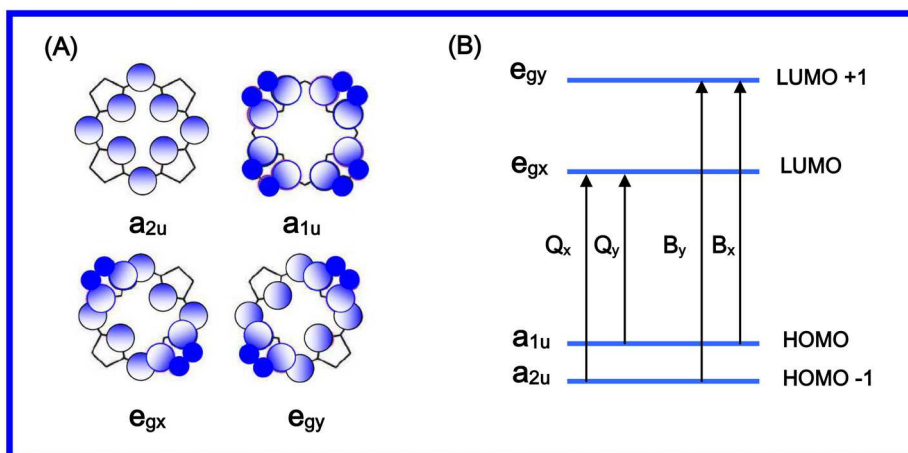

Fig. 7. Porphyrin HOMOs and LUMOs. (A) Representation of the four Gouterman orbitals in porphyrins. (B) Drawing of the energy levels of the four Gouterman orbitals upon symmetry lowering from D_{4h} to C_{2v} . The set of e_g orbitals gives rise to Q and B bands.

The relative intensity of Q bands is due to the kind and the position of substituents on the macrocycle ring. Basing on this latter consideration, porphyrins could be classified as *etio*, *rhodo*, *oxo-rhodo* e *phyllo* (Prins et al 2001).

When the relative intensities of Q bands are such that $IV > III > II > I$, the spectrum is said *etio-type* and porphyrins called *etioporphyrins*. This kind of spectrum is found in all porphyrins in which six or more of the β -positions are substituted with groups without π -electrons, e.g., alkyl groups. Substituent with π -electrons, as carbonyl or vinyl groups, attached directly to the β -positions gave a change in the relative intensities of the Q bands, such that $III > IV > II > I$. This is called *rhodo-type* spectrum (*rhodoporphyrin*) because these groups have a "reddening" effect on the spectrum by shifting it to longer wavelengths. However, when these groups are on opposite pyrrole units, the reddening is intensified to give an *oxo-rhodo-type* spectrum in which $III > II > IV > I$. On the other hand, when *meso*-positions are occupied, the *phyllo-type* spectrum is obtained, in which the intensity of Q bands is $IV > II > III > I$ (Milgron 1997).

While variations of the peripheral substituents on the porphyrin ring often cause minor changes to the intensity and wavelength of the absorption features, protonation of two of the inner nitrogen atoms or the insertion/change of metal atoms into the macrocycle usually strongly change the visible absorption spectrum.

When porphyrinic macrocycle is protonated or coordinated with any metal, there is a more symmetrical situation than in the porphyrin free base and this produces a simplification of Q bands pattern for the formation of two Q bands.

4. The equilibrium of porphyrins

Neglecting the overall charge of the macrocycle, a monomeric free-base porphyrin H_2-P in aqueous solution can add protons to produce mono H_3-P^+ and dication H_4-P^{2+} at very low pHs, or loose protons to form the centrally monoprotic $H-P^-$ at pH about 6 or aprotic P^{2-} species at pH ≥ 10 (Fig. 8). These chemical forms of porphyrin may exist in equilibrium, depending upon the pH of the solution and can be characterized from the change of the electronic absorption spectrum. The change in spectra upon addition of acid or basic substances can generally be attributed to the attachment or the loss of protons to the two imino nitrogen atoms of the pyrroline-like ring in the free-base (Gouterman, 1979; Giovannetti et al, 2010). The N-protonation induced a red-shifts that are consistent with frontier molecular orbital calculations for protonated porphyrins (Daniel et al., 1996).

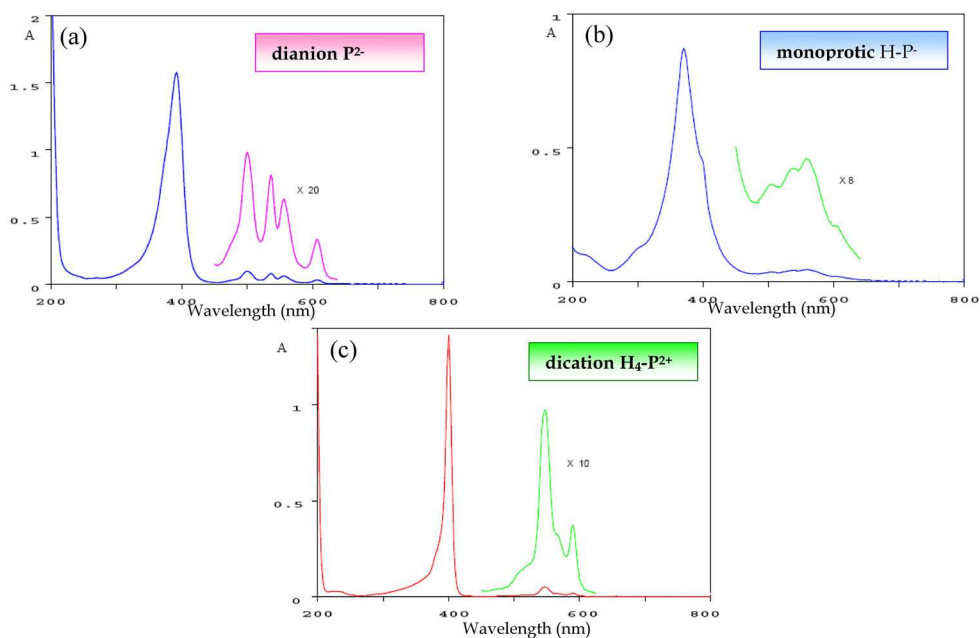

Fig. 8. Typical Uv-vis spectrum of dianion P^{2-} (pH about 10) monoprotic $H-P^-$ (pH about 6) and dication H_4-P^{2+} porphyrin (pH about 1).

Spectrophotometric titration was employed for determining the acid dissociation constants over the inter pH range and change in absorbance with pH can be attributed to the following acid dissociation reactions of porphyrins. Upon addition of acid the spectral pattern of porphyrins changes from the four Q-band spectrum, indicating D_{2h} symmetry for free-base porphine, to a two Q-band spectrum for the formation of dication H_4-P^{2+} (Fig. 8 c), indicating D_{4h} symmetry, characteristic of porphyrin coordinated to a metal ion through the

four N-heteronuclei. In addition, in all cases, the intense Soret band is red-shifted (to an extent dependent on the particular meso-substituents).

5. The reaction of porphyrins with metal ions: Regular and sitting-atop complexes

The metalloporphyrin formation reaction is one of the important processes from both analytical and bioinorganic points of view. The large molar absorption coefficient and the very high stability of porphyrins is valuable for the separation of various kinds of metal ions (Tabata et al., 1998). A variety of metalloporphyrin formation rates are also applicable for the kinetic analysis of metal ions (Tabata & Tanaka, 1991). Also, kinetic studies of metalloporphyrin formation are indispensable in order to understand in vivo metal incorporation processes leading to the natural metalloporphyrins. Generally porphyrins are synthesized in a metal-free form and metal ions are successively inserted.

When the metal ion M^{n+} is incorporated into the porphyrin H_2P to form $MP^{(n-2)+}$, the two amine protons in H_2P are dissociated from the two pyrrole groups as reported in equation (1):

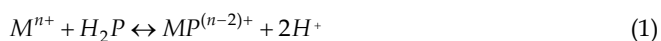

In the formation of metalloporphyrins an marked colour changes with transformation of the Uv-Vis spectrum especially in the Q zone has been observed. The two Q band obtained are called α and β (Fig. 9). The relative intensities of these bands can be correlated with the stability of the metal complex; in fact when $\alpha > \beta$, the metal forms a stable square-planar complex with the porphyrin, in the other case when $\beta > \alpha$ (e.g. Ni(II), Pd(II), Cd(II)), the metals are easily displaced by protons (Milgron, 1997).

Studies on water soluble and insoluble porphyrins have elucidated aspects of the mechanisms of metal ion incorporation into porphyrins to form metalloporphyrins (Bailey & Hambright, 2003; Hambright et al., 2001; Lavalley, 1987; Funahashi et al., 2001).

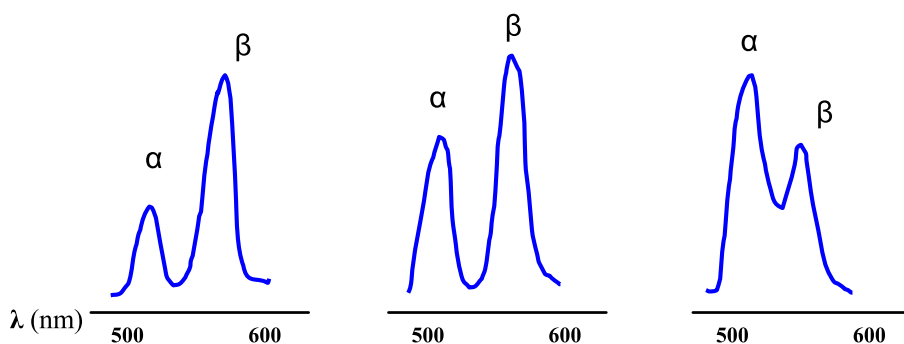

Fig. 9. Q band in the porphyrin metal complexes

The size of the porphyrin-macrocycle is perfectly suited to bind almost all metal ions and indeed a large number of metals can be inserted in the center of the macrocycle forming

metalloporphyrins that play key roles in several biochemical processes, due to their central role in photosynthesis, oxygen transport and in various redox reactions (Mathews et al., 2000; Garret & Grisham, 1999; Knör & Strasser, 2005; Lim et al., 2005; Martirosyan et al., 2004; Tovmasyan et al., 2008; Ren et al., 2010; Kawamura et al., 2011).

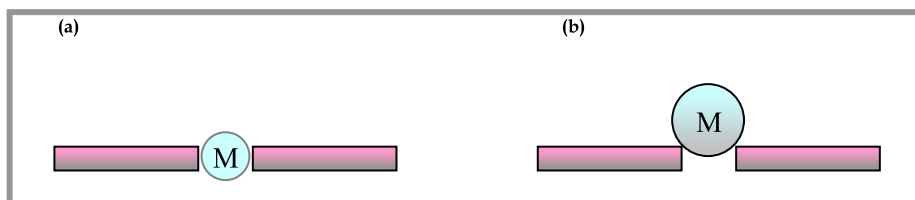

Fig. 10. Schematic representation of (a) regular and (b) SAT metalloporphyrins.

Depending on their size, charge, and spin multiplicity, metal ions (e.g. Zn, Cu, Ni, Co, etc.) can fit into the center of the planar tetrapyrrolic ring system forming *regular metalloporphyrins* resulting in a kinetically inert complexes (Fig. 10a).

When divalent metal ions (e.g. Co(II), Ni(II), Cu(II)) are chelated, the resulting tetracoordinate chelate has no residual charge. While Cu(II) and Ni(II) in their porphyrin complexes have generally low affinity for additional ligands, the chelates with Mg(II), Cd(II) and Zn(II) readily combine with one more ligand to form pentacoordinated complexes with square-pyramidal structure (Fig. 11a). Some metalloporphyrins (Fe(II), Co(II), Mn(II)) are able to form distorted octahedral (Fig. 11b) with two extra ligand molecules (Biesaga et al., 2000).

Most of the natural metalloporphyrins are of regular type, i.e. their metal centres are located within the plane of the macrocyclic ligand as a consequence of their fitting size. The cationic radii are in the range of 55–80 pm corresponding to the sphere in the porphyrin core surrounded by the four pyrrolic nitrogens. While the symmetry group of the free-base porphyrins is D_{2h} due to the two hydrogen atoms on the diagonally located pyrrolic nitrogens, the coplanar (regular) metalloporphyrins (without these protons) are of higher symmetry (Khan & Bruce, 2003).

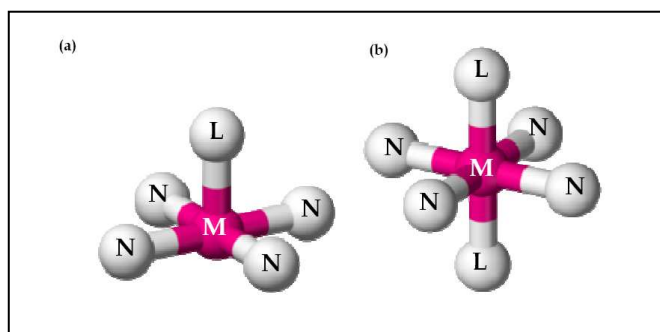

Fig. 11. Schematic pictures of square-pyramidal (a) and octahedral structures (b) (only enclose nitrogen N, metal M and extra ligands L).

If, however, the ionic radius of the metal ions is too large (over ca. 80-90 pm) to fit into the hole in the centre of the macrocycle, they are located out of the ligand plane, distorting it forming *sitting-atop* (SAT) *metalloporphyrins* (Fig. 10b) that are characterized by special properties (Fleischer & Wang 1960; Barkigia et al., 1980; Liao et al., 2006; Walker et al., 2010) originating from the non-planar structure caused by, first of all, the size of the metal center.

These complexes are kinetically labile and display characteristic structural and photoinduced properties that strongly deviates from those of the regular metalloporphyrins. The latter kind of structure induces special photophysical and photochemical features that are characteristic for all SAT complexes. The symmetry of this structures is lower (generally $C_{4v}-C_1$) than that of both the free-base porphyrin (D_{2h}) and the regular, coplanar metalloporphyrins (D_{4h}), in which the metal center fits into the ligand cavity.

The rate of formation of in-plane (or normal) metalloporphyrins is much slower than that of the SAT complexes because of the inflexibility of porphyrins. In fact, in an SAT complex the distortion of the porphyrin caused by the out-of-plane location of the metal center makes two diagonal pyrrolic nitrogens more accessible on the other side of the ligand due to the increase of their sp^3 hybridization (Tung & Chen, 2000).

Deviating from the regular metalloporphyrins, the SAT complexes, on account of their distorted structure and kinetic lability, display peculiar photochemical properties, such as photoinduced charge transfer from the porphyrin ligand to the metal center, leading to irreversible ring opening of the ligand and dissociation on excitation at both the Soret- and the Q-bands (Horváth et al., 2006). Moreover, the absorption and emission characteristics of these complexes are also significantly deviating from those of the normal (in-plane) metalloporphyrins (Horváth et al., 2006). Also the formation of bi and even trinuclear (bis-porphyrin) complexes has been observed (Lehn, 2002).

In Figure 12 is shown a schematic Energy-level diagram of the frontier orbital of a porphyrin in free-base state (H_2P), in a regular and in a SAT metalloporphyrin.

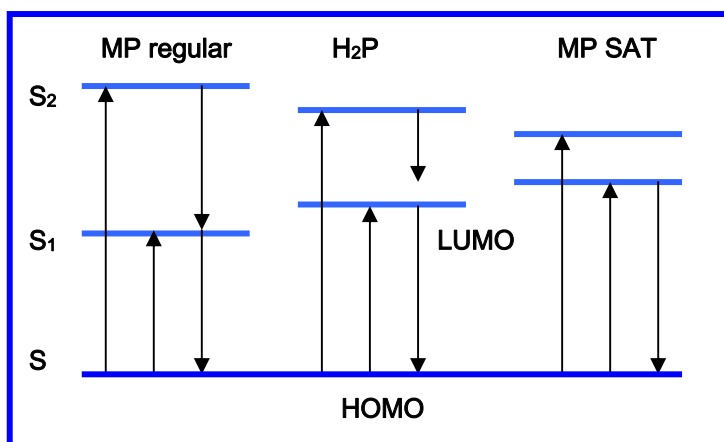

Fig. 12. Simplified energy-level diagram of the frontier orbital of a porphyrin in free-base state H_2P , in a regular and in a SAT metalloporphyrin.

The photoinduced behavior of normal metalloporphyrins have been thoroughly studied for several decades, while the investigation of SAT complexes started in this respect only in the past 8–10 years (Horváth et al., 2004; Valicsek et al., 2008; Valicsek et al., 2009; Valicsek et al., 2007; Huszánk et al., 2005; Huszánk et al., 2007; Valicsek et al., 2011).

Interestingly, in the case of lanthanide ions as metal centers, triple decker porphyrin sandwich complexes were also synthesized and studied (Wittmer & Holten, 1996).

While the natural porphyrin derivatives are exclusively hydrophobic, some artificial porphyrins having ionic substituents made it possible to prepare water-soluble metalloporphyrins of both regular and SAT type. Kinetically labile complexes are mostly examined in the excess of the ligand.

In the case of metalloporphyrins, however, metal ions are applied generally in excess, especially for spectrophotometric measurements, partly because of the extremely high molar absorbances (mainly at the Soret-bands) of the porphyrins. The formation of kinetically labile SAT complexes, deviating from the regular metalloporphyrins, is an equilibrium process. It can be spectrophotometrically monitored because the absorption and emission bands assigned to ligand-centered electron transitions undergo significant shift and intensity change upon coordination of metal ions.

Special attention was devoted to the reaction of porphyrins with essential metal ions as manganese, iron and chromium show that the most important properties of manganese in complex biological systems is the highly variable oxidation states of the metal from +2 to +5 (Kadish et al. 1999). All these compounds can be easily spectrophotometrically distinguished among them; this is because they have different absorption spectra (Spasojevic & Batinic-Haberle, 2001,) from which is possible to know the oxidation state. Manganese–porphyrin complexes have more extensively studied because were found to be similar to the biologically active compounds (Nakanishi et al. 2000; Meunier, 1992; Perie & Barbe, 1996; Balahura & Kirby, 1994; Haber et al., 2000; Cuzzocrea et al., 2001), and because were also used as catalysts for the oxygenation of alkanes, alkenes and compounds containing nitrogen and sulphur (Mansuy & Momenteau, 1982; Fontcave & Mansuy, 1984). The very important properties that influence the reactivity of the Mn(III)-porphyrin concerns the changes in the oxidation states of Mn in the complexes for its high reactivity with O₂ (Cuzzocrea et al., 2001). Manganese, in the complexes obtained by the reaction of Mn(II) with the porphyrins, has oxidation number +3, so the complex of Mn(II) can be obtained only by reduction, while those of Mn(IV) and Mn(V) for the oxidation of Mn(III)-complexes. Interesting is the reactions of a natural porphyrin, the acid 2,7,12,17 tetrapropionic of 3,8,13,18 tetramethyl-21H, 23H-porphyrin called Coproporphyrin- I (CPI), with manganese (III) that, with different pH and solvent compositions, show the formation of [Mn^{III}CPI(H₂O)₂], [Mn^{III}CPI(OH)₂], [Mn^{IV}(O)CPI(OH)], [Mn^V(O)CPI(OH)], [Mn^{II}CPI(OH)] (Fig. 13) with specific Uv-Vis adsorptions as reported in Table 1. (Giovannetti et al., 2010).

5.1 Complexation kinetics

Rates of the complexation of porphyrins with metal ions are very much slower by several orders of magnitude than those of acyclic ligands (Funahashi, S. et al., 1984). Such very slow rates have been discussed in terms of the rigidity of the planar porphyrin framework. The electronic nature of porphyrins, and also the steric accessibility of the bound metal center,

can be varied by using electron-donating or with drawing substituents at the meso carbon or in the pyrrolic positions. While such substituent-based changes have been seen to influence the extent of apical ligand binding, as well as the stability of the metal complexes, there is a relatively small effect on the ability to insert cations into the nitrogen core (Lin & Lash, 1995).

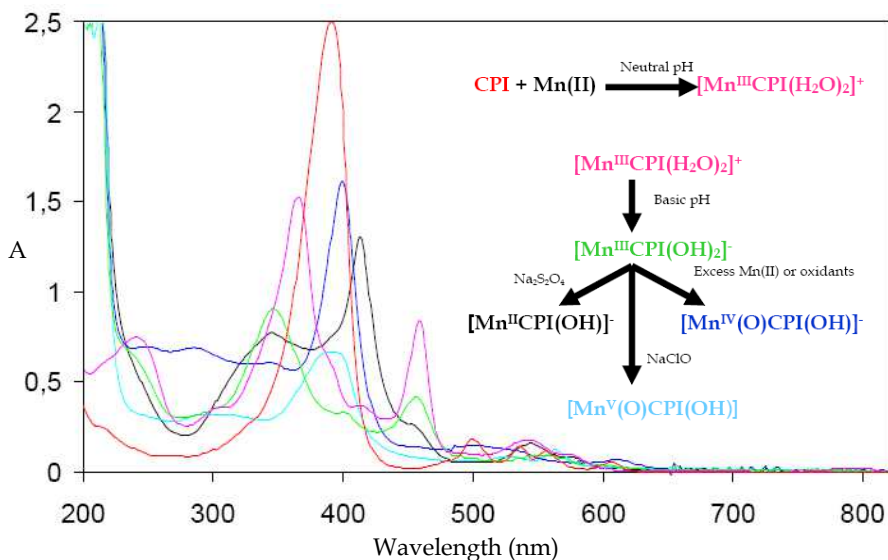

Fig. 13. Uv-Vis adsorption spectra of CPI, $[\text{Mn}^{\text{III}}\text{CPI}(\text{H}_2\text{O})_2]^+$, $[\text{Mn}^{\text{III}}\text{CPI}(\text{OH})_2]^-$, $[\text{Mn}^{\text{IV}}(\text{O})\text{CPI}(\text{OH})]^-$, $[\text{Mn}^{\text{V}}(\text{O})\text{CPI}(\text{OH})]^-$, $[\text{Mn}^{\text{II}}\text{CPI}(\text{OH})]^-$ with in insert, the experimental conditions for the preparation of all complexes obtained with several reagents.

Complex	Soret band λ (nm)	Q band (β , α) λ (nm)
$[\text{Mn}^{\text{II}}\text{CPI}(\text{OH})]^-$	414	544, 574
$[\text{Mn}^{\text{III}}\text{CPI}(\text{H}_2\text{O})_2]^+$	366, 458	542, 572
$[\text{Mn}^{\text{III}}\text{CPI}(\text{OH})_2]^-$	348, 458	556
$[\text{Mn}^{\text{IV}}(\text{O})\text{CPI}(\text{OH})]^-$	400	502, 610
$[\text{Mn}^{\text{V}}(\text{O})\text{CPI}(\text{OH})]^-$	384	526, 562

Table 1 Spectral characteristics of Mn-CPI complexes.

In the case of N-substituted porphyrins, in which one of the two hydrogen atoms bound to the pyrrole nitrogen atoms is substituted by an alkyl or aryl group, displacement of the substituent from the porphyrin plane due to its bulkiness causes tilting distortion of the pyrrole rings of the porphyrin as shown by X-ray crystallography (Lavallee & Anderson, 1982; Aizawa et al., 1993). The investigation of the kinetics of the complexation of N-substituted porphyrins with several metal ions, showing that N-alkylporphyrins form metal complexes much faster than corresponding non-N-alkylated porphyrins (Aizawa et al., 1993; Shah et al., 1971; Shah et al., 1971; Anderson & Lavallee, 1977; Lavalle et al., 1978; Anderson et al., 1980; Kuila & Lavallee, 1984; Schauer et al., 1987; Balch et al., 1990; McLaughlin, 1974;

Bain-Ackerman & Lavalley, 1979; Funahashi et al., 1984; Funahashi et al., 1986; Lavalley et al., 1986; Bartczak et al., 1990; Shimizu et al., 1992).

The formation of metalloporphyrins can be accelerated substantially by the use of an auxiliary complexing agent. For example, the rate of complexation of TMPyP with Cu(II) and Mg(II) was accelerated by L-cysteine (Watanabe & Ohmori 1981) and 8-quinolinol (Makino & Itoh, 1981), respectively. The organic ligands with an extended π -electron structure, such as imidazole or bipyridine (Giovannetti et al., 1995; Kawamura et al., 1988; Ishi & Tsuchiai 1987; Tabata & Kajihara, 1989) and L-tryptophan (Tabata & Tanaka, 1988) also show a tendency to accelerate the formation of metalloporphyrins because form intermediate molecular complexes with metal ions and porphyrin reagents. In the presence of tryptophan, the rate of incorporation of Zn(II) to TPPS4 is about 100 times greater than in its absence (Tabata & Tanaka, 1988).

Hence, larger metal ions such as Pb^{2+} , Hg^{2+} , or Cd^{2+} can catalyse the formation of regular metalloporphyrins via generation of SAT complexes as intermediates. This because in the SAT complexes, the distortion caused by the out-of-plane location of the larger metal center, makes two diagonal pyrrolic nitrogens more accessible to another metal ion, even with smaller ionic radius, on the other side of the porphyrin ligand that can easily coordinate to them (Stinson & Hambright, 1977; Inamo et al 2001; Wittmer & Holten, 1996; Tabata & Tanaka 1985; Tung & Chen, 2000; Tabata et al., 1995; Grant & Hambright 1969; R. Robinson & Hambright, 1992; C. Stinson & Hambright, 1977; Barkigia et al., 1990; Giovannetti et al., 1998).

Since the deformation of the porphyrin ring proved to be the main factor governing the acceleration of the metalloporphyrin formation (Lavalley, 1985; Tabata & Tanaka, 1991), this can also be achieved by substituents at the porphyrin core or at the peripheral ring. Thus, e.g., the peripheral or substituted octabromoporphyrins display a buckled structure due to steric hindrance between the substituents (Bhyrappa & Krishnan, 1991; Mandon et al., 1992; Henling et al., 1993; Brinbaum et al., 1995). Such a deformation profoundly enhanced the reactivity of the porphyrin even towards Hg^{2+} (Nahar & Tabata, 1998), the ionic radius of which is rather large anyway.

6. Aggregation of porphyrins

An increasing interest in recent years is due to supramolecular assemblies of π -conjugated systems for their potential applications in optoelectronic and photovoltaic devices (Schenning & Meijer, 2005).

Molecular aggregates of several dyes have been studied as organic photoconductors (Borsenberger et al., 1978), as markers for biological and artificial membrane systems (Waggoner, 1976), as materials with high non-linear optical properties suitable for optical devices ([Hanamura, 1988; Sasaki & Kobayashi, 1993; Wang, 1986; Wang, 1991). Some properties of molecular structure of aggregates permit their use in superconductivity, and other processes (Kobayashi, 1992; Schouten et al., 1991; Collman, 1986). Aggregation of small organic molecules to form large clusters is of large interest in chemistry, physics and biology. In nature, particularly in living systems, self-association of molecules plays a very important role; an example is given by molecular aggregates of chlorophyll that have been found to mediate the primary light harvesting and charge-transfer processes in photosynthetic complexes (Creighton et al., 1988; Kuhlbrandt, 1995). In fact, light-harvesting

and the primary charge-separation steps in photosynthesis are facilitated by aggregated species, i.e., chlorophylls.

Self-assembly of molecules, driven by not-covalent intermolecular interactions, is a convenient route for manufacturing of new functional materials (Lidzey et al., 2000; Van der Boom et al., 2002; Fudickar et al. 2002; Lagoudakis et al., 2004; Li et al., 2003).

Recently, porphyrin assembly has been used for light-driven energy transduction systems, copying the photophysical processes of photosynthetic organisms (Choi et al., 2004); Choi et al., 2003; Choi et al., 2002; Choi et al., 2001; Luo et al., 2005).

The aggregation and dimerization of porphyrins and metalloporphyrins in aqueous solution have been widely investigated (Borissevitch & Gandini, 1998; Pasternack et al, 1985) and it has been deduced that it is dependent strictly on physical-chemical characteristics, such as, ionic strength, pH and solvent composition; the combination of these factors can facilitate the aggregation processes (Kubat et al., 2003; Giovannetti et al., 2010).

The aggregation of porphyrins, changing their spectral and energetic characteristics, influences their efficacy in several applications thus, it is very important take on detailed informations about the formation dynamic and on the typology of aggregates. In the metal complexation of porphyrins the efficiency reaction is affected by their aggregation (Yusmanov et al, 1996). Several authors have observed that in the photogeneration of H_2O_2 by porphyrins, the efficiency of production was highly dependent on their aggregation state (Komagoe et al, 2006).

The diverse chemical and photophysical properties of porphyrins are in many cases due to their different aggregation mode and, as a result of interchromophoric interactions, perturbations in the electronic absorption spectra of dyes occur. Deviations from Beer's law are often used to investigate the porphyrin aggregation in solution.

Because the aggregates of porphyrins show peculiar spectroscopic properties, the molecular associations of porphyrins were generally investigated using UV-vis absorption and fluorescence spectroscopy (Ohmo, 1993).

The characteristic of porphyrin molecule with 22 π -electrons causes a strong π - π interaction (Van de Craats, & Warman, 2001), facilitating the formation of two structure types: "H-type" with bathochromic shift of B and Q bands and "J-type" with blue shift of B band and red-shift of Q band, with respect to those of monomer.

The J-type aggregates (side-by-side) were formed for transitions polarized parallel to the long axis of the aggregate, while H-type (face-to-face) for transitions polarized perpendicular to it (Fig. 14).

J-aggregates are formed with the monomeric molecules arranged in one dimension such that the transition moment of the monomers are parallel and the angle between the transition moment and the line joining the molecular centers is zero (Bohn, 1993). The strong coupling of monomers results in a coherent excitation with a red-shift relative to the monomer band. *H-aggregates* are again a one-dimensional arrangement of strongly coupled monomers, but the transition moments of the monomers are perpendicular (ideal case) to the line of centers. On the contrary of J-aggregates, the arrangement in H-aggregates is face-to-face. The dipolar coupling between monomers leads to a blue shift of the absorption band (Czikklely et al.,

1970; Nuesch et al., 1995). The H-aggregates are not known to have sharp spectra like the J-aggregates; nevertheless, there are many examples where the spectroscopic blue shift, evident for formation of H-aggregates, was observed.

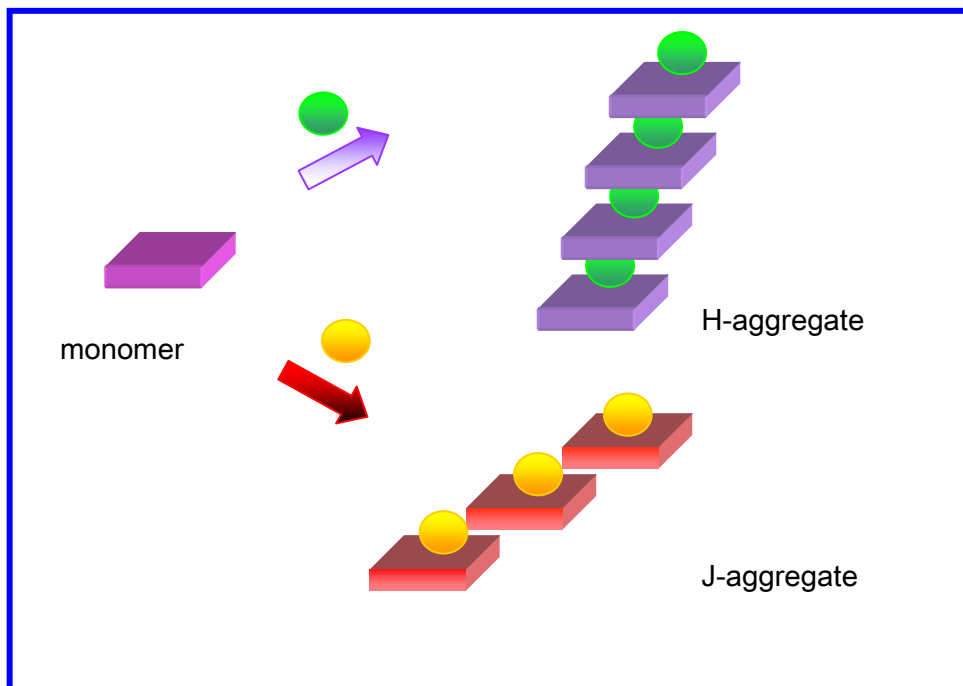

Fig. 14. Schematic representation of H and J aggregates.

These aggregated are of particular interest because the highly ordered molecular arrangement present unique electronic and spectroscopic properties that can be predicted (Fidder et al., 1991; West & Carroll,1966; Furuki et al., 1989; Spano & Mukamel, 1989; Bohn, 1993).

H and J aggregates can be obtained under specific conditions (Misawa & Kobayashi, 1999; Maiti et al., 1995; Kanojk & Kobayashi, 2002; Pasternack et al., 1994; Akins et al., 1994; Ohno et al., 1993; Luca et al., 2005; Luca et al., 2006; Luca et al., 2006). Due to the distinct optical properties, also the control of the formation of H- and J-aggregated states of dyes has attracted much research interest (Maiti et al., 1998; Shirakawa et al., 2003; De Luca et al., 2006; Egawa et al., 2007; Yagai et al., 2008; Gadde et al., 2008; Ghosh et al., 2008; Zhao et al., 2008; Delbosc et al., 2010).

As a result, a wide variety of self-assembled porphyrin structures are highly desirable for practical use, which can be applied to nonlinear optical materials (Collini et al., 2006; Liu et al., 2006; Matsuzaki et al., 2006; Terazima et al., 1997), organic solar cells (Hasobe et al., 2003) and sensor devices (Fujii et al., 2005; Lucaet al., 2007).

In general, the aggregate formation of porphyrins have been studied in solution, and their physicochemical properties can be affected by the ionic strength, nature of the titrating acid,

temperature, pH, peripheral substitution and presence of surfactants of ions (Choi et al., 2003; Ohno et al., 1993; Napoli et al., 2004; Kubat et al., 2003; Siskova et al., 2005).

H- and J-aggregates was formed by simply mixing aqueous solutions of two kinds of porphyrins with opposite charges (Xiangqing et al., 2007).

Moreover, self-assembly can be mediated by templates that allows for obtaining aggregates with additional properties, e.g., chiral templates (Koti & Periasamy, 2003; Mammana et al., 2007). In these systems, coupling of strong transition dipoles can result in a perturbations to the electronic absorption spectra of monomer with hypsochromic and bathochromic shift of the monomer Soret band, for H and J aggregates formation respectively (Gourterman et al., 1977; Zimmermann et al., 2003; Scherz & Parson, 1984). The produced splitting is proportional to the magnitude of transition dipole coupling between adjacent molecules.

Although much has been studied about the spectroscopic features and excitonic interactions in molecular aggregates, the detailed information of geometrical structure, especially the molecular orientation, are still the subjects of continuing interests (Nikiforov et al., 2008; Jeukens et al., 2004).

The aggregates of porphyrins have been formed in solutions in the form of fibers, ribbons and tubules by the self-association or aggregation method (Rotomskis, 2004; Fuhrhop, 1993; Giovannetti et al., 2010).

Some H- or J-type aggregates of porphyrins play a role as light harvesting assemblies to gather and transfer energy to the assembled devices, and to obtain a higher incident photon-to-photocurrent generation efficiency (Kamat et al., 2000; Sudeep et al., 2002).

The structural, kinetic, and spectroscopic studies on J- and H-aggregates provide useful information for understanding molecular interactions in aggregation processes.

The kinetics of the formation of the porphyrin aggregate and its structure are sensitive of experimental conditions (Giovannetti et al., 2010). The monomer – aggregated species is a system of multiple equilibria. Spectrophotometric monitoring in the time of the Uv- Vis absorbance permit to obtain information of intermediate species, of type of the aggregate, and of their transformation. For this, for evaluated the polymerization kinetic constants, the concentrations of monomeric [M] and dimeric form [D], can be calculated from the relative absorption maxima at each time. If k_{pol} is the polymerisation kinetic constant, C_M and C_D denoted the initial monomer and dimer concentrations, the reaction rate can be expressed as in equation (2):

$$k_{pol}t = \frac{1}{C_M - C_D} \ln \frac{C_D[M]}{C_M[D]} \quad (2)$$

The plot of the right term of this equation versus t gave good straight lines the slopes of which represented the values of k_{pol} .

The information derived from such studies can help in achieving appropriate design of photoactive aggregates for mimicking light-harvesting natural photosynthetic pigments, photodynamic therapeutic use, and advanced nonlinear optical materials.

7. Conclusions

The porphyrins represent a fascinating world of molecules with sensational properties. Many results have been obtained by careful observation and with detailed studies of their chemical and physical properties due to the use of UV-Vis spectrophotometry between the interpretation of Soret and Q band transformations.

In this contest, the light absorbing power of porphyrins and related compounds should be used in the near future for other many applications and much more can still be studied in the future.

8. References

- Acheson, R.M. (1976). *An Introduction to the Chemistry of Heterocyclic Compounds*, 3rd ed; John Wiley & Sons: New York.
- Adler, A. D. Longo, F. R. Finarelli, J. D. Goldmacher, J. Assour, J. Korsakoff, L. (1967). *J. Org. Chem.* 32, 476.
- Aizawa, S. Tsuda, Y. Ito, Y. Hatano K. Funahashi, S. (1993). *Inorg. Chem.*, 32, 1119.
- Akins, D. L. Zhu, H.-R. Guo, C. (1996). *J. Phys. Chem.*, 100, 5420.
- Akins, D. L. Zhu, H.-R. Guo, C. (1994). *J. Phys. Chem.*, 98, 3612.
- Anderson, H.J. Loader, C.E. Jackson, A.H., (1990) In *Pyrrole*, Jones, R. A. Ed. *The Chemistry of Heterocyclic Compounds*, Vol. 48, John Wiley & Sons: New York 295-397.
- Anderson O.P. Lavalley, D.K. (1976). *J. Am. Chem. Soc.*, 98, 4670.
- Anderson O.P. Lavalley, D.K. (1977). *J. Am. Chem. Soc.*, 99, 1404.
- Anderson O.P. Lavalley, D.K. (1977). *Inorg. Chem.*, 16, 1634.
- Anderson, O.P. Kopelove A.B. Lavalley, D.K. (1980). *Inorg. Chem.*, 19, 2101.
- Arai Y. & Segawa H. (2011). *J. Phys. Chem. B*, 115, 7773.
- Atwood, J.L. Davies, J.E.D. MacNicol, D.D. Vogtle, F. Lehn, J.-M., Eds., *Handbook : Comprehensive Supramolecular Chemistry*, (1996). Pergamon, Oxford.
- Bailey, S. L. , Hambright P. (2003). *Inorganica Chimica Acta* , 344, 43.
- Bain-Ackerman M.J. Lavalley, D.K. (1979). *Inorg. Chem.*, 18, 3358.
- Balaban, T. S. (2005). *Acc.Chem. Res.*, 38, 612.
- Balahura, R.J. Kirby, R.A. (1994). *Inorg. Chem.*, 33, 1021.
- Balaz, M. Holmes, A.E. Benedetti, M. Rodriguez, P.C. Berova, N. Nakanishi, K. Proni, G., (2005). *J. Am. Chem. Soc.*, 127, 4172.
- Balch, A.L. Cornman, C.R. Latos-Grazynski L. Olmstead, M.M. (1990), *J. Am. Chem. Soc.*, 112, 7552.
- Barkigia, K.M. Berber, M.D. Fajer J., Medforth, C.J. Renner M.W., Smith, K.M. (1990). *J. Am. Chem. Soc.*, 112,
- Barkigia, K.M. Fajer, J. Adler, A.D. Williams, G.J.B. (1980). *Inorg. Chem.*, 19, 2057.
- Bartczak, T.J. Latos-Grazynski L. Wyslouch, A. (1990). *Inorg. Chim. Acta*, 171, 205.
- Beletskaya, I. Tyurin, V. S. Tsivadze, A. Y. Guillard, R. Stern, C. (2009). *Chem. Rev.*, 109, 1659.
- Bhyrappa, P. Krishnan, V. (1991) *Inorg. Chem.*, 30, 239.
- Biesaga, M. Pyrzynska, K. Trojanowicz, M. (2000). *Talanta*, 51, 209.
- Bohn, P. W. (1993). *Annu. Rev. Phys. Chem.*, 44, 37.
- Borissevitch, I.E. Gandini, S.C. (1998). *J. Photochem. Photobiol. B: Biol.*, 43, 112.
- Borsenberger, P. Chowdry, A. Hoesterey, D. Mey, W. (1978). *J. Appl. Phys.*, 44, 5555.

- Brinbaum, E.R. Hodge, J.A. Grinstaff, M.W. Schaefer, W.P. Henling, L. Labinger, J.A. Bercaw, J.E. Gray, H.B. (1995). *Inorg. Chem.*, 34, 3625.
- Calvin, M. Ball, R. H. Arnoff, S. (1943). *J. Am. Chem. Soc.*, 65, 2259.
- Choi, M. Y. Pollard, J. A. Webb, M. A. McHale, J. L. (003). *J. Am. Chem. Soc.*, 125, 810.
- Choi, M.-S. Aida, T. Luo, H. Araki, Y. Ito, O. (2003). *Angew. Chem., Int. Ed.*, 42, 4060.
- Choi, M.-S. Aida, T. Yamazaki, I. Yamazaki, T. (2001). *Angew. Chem., Int. Ed.*, 40, 194.
- Choi, M.-S. Aida, T. Yamazaki, I. Yamazaki, T. (2002). *Chem. Eur. J.*, 8, 2667.
- Choi, M.-S. Aida, T. Yamazaki, I. Yamazaki, T. (2004). *Angew. Chem., Int. Ed.*, 43, 150.
- Collini, E. Ferrante, C. Bozio, R. Lodi, A. Ponterini, G. (2006). *J. Mater. Chem.* 16, 1573.
- Collman, J.P. McDeevitt, J.T. Yee, G.T. Leidner, C.R. McCullough, L.G. Little, W.A. Torrance, J.B. (1986). *Proc. Natl. Acad. Sci. U.S.A.*, 83, 44581.
- Creighton, S. Hwang, J. Warshel, A. Parson, W. Norris, J. (1988). *Biochemistry*, 27, 774.
- Cuzzocrea, S. Riley D.P., Caputi A.P., Salvemini D. (2001). *Pharmacol. Rev.*, 53, 135.
- Czikklely, V. Forsterling, H. D. Kuhn, H. (1970). *Chem. Phys. Lett.*, 6, 207.
- Dailey, H.A. Ed. (1990) *Biosynthesis of Heme and Chlorophylls*, McGrawHill, Inc.: New York.
- De Luca, G. Pollicino, G. Romeo, A. Scolaro, L. M. (2006). *Chem. Mater.*, 8, 18.
- De Luca, G. Romeo, A. Scolaro, L. M. (2005). *J. Phys. Chem. B*, 109, 7149.
- De Luca, G.; Romeo, A.; Scolaro, L. M. (2006). *J. Phys. Chem. B*, 110, 14135.
- De Luca, G.; Romeo, A.; Scolaro, L. M. (2006). *J. Phys. Chem. B*, 110, 7309.
- Delbosc, N. Reynes, M. Dautel, O. J. Wantz, G. Lere-Porte, Fidder, H. Terpstra, J. Wiersma, D. A. (1991). *J. Chem. Phys.*, 94, 6895.
- Delbosc, N. Reynes, M. Dautel, O. J. Wantz, G. Lere-Porte, J.-P. Moreau, J. J. E. (2010). *Chem. Mater.*, 22, 5258.
- Di Natale, C. Salimbeni, D. Paolesse, R. Macagnano, A. D'Amico, A., (2000). *Sens. Actuators, B*, 65, 220
- Di Natale, C. Paolesse, R. D'Amico, A., (2007). *Sens. Actuators, B*, 121, 238.
- Dolphin, D. Ed *The Porphyrins*, (1978). Academic, New York.
- Drain, C. M. Alessandro, V. Radivojevic, I. (2009). *Chem. Rev.*, 109, 1630.
- Egawa, Y. Hayashida, R. Anzai, J. (2007). *Langmuir*, 23, 13146.
- Elemans, J. A. A. W. Van Hameren, R. Nolte, R. J. M. Rowan, A. E. (2006). *Adv. Mater.*, 18, 1251.
- Fleischer, E.B. Wang, J.H. (1960). *J. Am. Chem. Soc.*, 82, 3498.
- Fontecave, M. Mansuy, D. (1984). *Tetrahedron Lett.*, 21, 4297.
- Fuhrhop, J.H. Bindig, U. Siggel, U. (1993). *J. Am. Chem. Soc.*, 115, 11036.
- Fujii, Y. Hasegawa, Y. Yanagida, S. Wada, Y. (2005). *Chem. Commun.* 3065.
- Funahashi S., Inada, Y. Inamo, (2001). *M. Anal. Sci.* 917.
- Funahashi, S. Ito, Y. Kakito, H. Inamo, M. Hamada Y. Tanaka, M. (1986). *Mikrochim. Acta*, 33.
- Funahashi, S. Yamaguchi, Y. Tanaka, M. (1984). *Bull. Chem. Soc. Jpn.*, 57, 204.
- Funahashi, S. Yamaguchi, Y. Tanaka, M. (1984). *Inorg. Chem.*, 23, 2249
- Furuki, M. Ageishi, K. Kim, S. Ando, I. Pu, L. S. (1989). *Thin Solid Films*, 180, 193.
- Gadde, S. Batchelor, E. K. Weiss, J. P. Ling, Y. Kaifer, A. E. (2008). *J. Am. Chem. Soc.*, 130, 17114.
- Ghosh, S. Li, X. Stepanenko, V. Wrthner, F. (2008). *Chem. Eur. J.*, 14, 11343.
- Giovannetti R., Alibabaei, L. Petetta, L. (2010). *Journal of Photochemistry and Photobiology A: Chemistry*, 211,108.
- Giovannetti, R. Bartocci, V. Ferraro, S. Gusteri, M. Passamonti, P. (1995). *Talanta*, 42, 1913.

- Giovanetti, R. Alibabaei, L. Pucciarelli, F. (2010). *Inorganica Chimica Acta*, 363, 1561.
- Goldberg D.E. Thomas, K.M. (1976). *J. Am. Chem. Soc.*, 98, 913.
- Gourterman, M. Holten, D. Lieberman, E. (1977). *Chem. Phys.*, 25, 139.
- Gouterman, M. (1961). *J. Mol. Spectroscopy*, 6, 138.
- Gouterman, M. (1959). *J. Chem. Phys.*, 30, 1139.
- Grant, C. Hambright, P. (1969). *J. Am. Chem. Soc.*, 91, 4195.
- Gulino, A. Mineo, P. Bazzano, S. Vitalini, D. Fragalà, I., (2005). *Chem. Mater.*, 17, 4043.
- Haber, J. Matachowski, L. Pamin, K. Potowicz, J. (2000). *J. Mol. Catal. A*, 162, 105.
- Hambright, P. in K.H. Kadish, K.M. Smith, R. Guilard (Eds.), *The Porphyrin Handbook*, (2001). vol. 3 (chap. 18), Academic Press, New York.
- Hanamura, E. (1988). *Phys. Rev. B*, 37, 1273.
- Hasobe, T. Imahori, H. Fukuzumi, S. Kamat P.V., (2003). *J. Mater. Chem.*, 13, 2515.
- Henling, L.M. Schaeffer, W.P. Hodge, J.A. Hughes, M.E. Gray, H.B. (1993). *Acta Crystallogr.*, 49, 1743.
- Hoeben, F. J. M. Jonkheijm, P. Meijer, E. W. Schenning, A. P. H. (2005). *J. Chem. Rev.*, 105, 1491.
- Horváth, O. Huszánk, R. Valicsek, Z. Lendvay, G. (2006). *Coord. Chem. Rev.*, 250, 1792.
- Horváth, O. Valicsek, Z. Vogler, A. (2004). *Inorg. Chem. Commun.*, 7, 854.
- Huszánk, R. Horváth, O. (2005). *Chem. Commun.* 224.
- Huszánk, R. Lendvay, G. Horváth, O. (2007). *J. Bioinorg. Chem.*, 12, 681.
- Inamo, M. Kamiya, N. Inada, Y. Nomura, M. Funahashi, S. (2001). *Inorg. Chem.*, 40, 5636.
- Ishi, H. Tsuchiai, H. (1987) *Anal. Sci.*, 3, 229.
- Jeukens, C.R.L.P.N. Lensen, M.C. Wijnen, F.J.P. Elemans, J.A.A.W. Christianen, P.C.M. Kadish, K.M. Smith, K.M. Guilard, R. (1999). *The Porphyrin Handbook*, Academic Press, S. Diego, CA.
- Kahn, K. Bruce, T.C., (2003). *J. Phys. Chem. B*, 107, 6876.
- Kamat, P.V. Barazzouk, S. Hotchandani, S. Thomas, K.G. (2000). *Chem. Eur. J.*, 6, 3914.
- Kamat, P.V. Barazzouk, S. Thomas, K.G. Hotchandani, S. (2000). *J. Phys. Chem. B*, 104, 4014.
- Kano, H. Kobayashi, T. J. (2002). *Chem. Phys.*, 116, 184.
- Kawamura, K. Igarashi, S. Yotsuyanagi, T. (2011). *Microchim. Acta*, 172, 319.
- Kawamura, K. Igarashi, S. Yotsuyanagi, T. (1988). *Anal. Sci.*, 4, 175.
- Kilian, K. Pyrzyńska, K. (2003). *Talanta*, 60, 669.
- Knör, G. Strasser, A. (2005). *Inorg. Chem. Commun.*, 9, 471.
- Kobayashi, (1992). *S. Mol. Cryst. Liq. Cryst.*, 217, 77.
- Komagoe, K. Katsu, T. (2006). *Anal. Sci.*, 22, 255.
- Koti, A.S.R. Periasamy, N. (2003). *Chem. Mater.*, 15, 369.
- Kubat, P. Lang, K. Prochazková, K. Anzenbacher Jr., P. (2003). *Langmuir*, 19, 422.
- Kuhlbrandt, W. (1995). *Nature*, 374, 497.
- Kuila D. Lavalley, D.K. (1984). *J. Am. Chem. Soc.*, 106, 448.
- Lagoudakis, P.G. de Souza M.M., Schindler F., Lupton J.M., Feldmann, J. Wenus, J. Lidzey, D.G. (2004). *Phys. Rev. Lett.*, 93, 257401.
- Lavalley D.K. and Anderson, O.P. (1982). *J. Am. Chem. Soc.*, 104, 4707.
- Lavalley, D.K. (1987). *The Chemistry and Biochemistry of N-Substituted Porphyrins*, VCH, New York.
- Lavalley, D.K. (1985). *Coord. Chem. Rev.*, 61, 55.
- Lavalley, D.K. Kopelove A.B. Anderson, O.P. (1978). *J. Am. Chem. Soc.*, 100, 3025.

- Lavallee, D.K. Wite, A. Diaz, ABattioni . J.-P. Mansuy, D. (1986). *Tetrahedron Lett.*, 27, 3521.
- Lehn, J.-M., (2002). *Science*, 295, 2400.
- Li, G. Fudickar, W. Skupin, M. Klyszcz, A. Draeger, C. Lauer, M. Fuhrhop, J.-H. (2002). *Angew. Chem. Int. Edit* 41, 1828.
- Li, L.-L. Yang, C.-J. Chen, W.-H. Lin, K.-J. (2003). *Angew. Chem. Int. Edit* 42, 1505.
- Liao, M.S. Watts, J.D. Huang, M.J. (2006). *J. Phys. Chem. A*, 110, 13089.
- Lindsey, J. S. Schreiman, I.C. Hsu, H.C. Kearney, P.C. Marguerettaz, A.M. (1987). *J. Org. Chem.* 52, 827.
- Lidzey, D.G. Bradley, D.D.C. Armitage, A. Walker, S. Skolnick, M.S. (2000). *Science*, 288, 1620.
- Lim, M.D. Lorkovic, I.M. Ford, P.C. (2005). *J. Inorg. Biochem.*, 99, 151.
- Lin, Y. Lash, T. (1995). *Tetrahedron Lett.*, 36, 9441
- Liu, Z.-B. Zhu, Y.-Z. Chen, S.-Q. Zheng, J.-Y. Tian, J.-G. (2006). *J. Phys. Chem. B*, 110, 15140.
- Luca, G.D. Pollicino, G. Romeo, A. Scolaro, L.M. (2007). *Chem. Mater.*, 18, 2005.
- Luca, G.D. Romeo, A. Scolaro, L.M. (2005). *J. Phys. Chem. B*, 109, 7149.
- Luca, G.D. Romeo, A. Scolaro, L.M. (2006). *J. Phys. Chem. B*, 110, 14135.
- Luca, G.D. Romeo, A. Scolaro, L.M. (2006). *J. Phys. Chem. B*, 110, 7309.
- Luo, H. Choi, M.-S. Araki, Y. Ito, O. Aida, T. (2005). *Bull. Chem. Soc. Jpn.*, 78, 405.
- Ma, S.Y. (2000). *J. Chem. Phys. Lett*, 332, 603,
- Maiti, N. C. Mazumdar, S. Periasamy, N. (1998). *J. Phys. Chem. B* 102, 1528.
- Maiti, N.C. Ravikanth, M. Mazumdar, S. Periasamy N., (1995). *J. Phys. Chem.*, 99, 17192.
- Makino, T. Itoh, J. (1981) *Clin. Chim. Acta*, 111, 1.
- Mammana, A. Durso, A. Lauceri, R. Purrello, R. (2007). *J. Am. Chem. Soc.*, 129, 8062.
- Mandon, D. Ochsenbein, P. Fischer, J. Weiss, R. Jayaraj, K. Austin, R.N. Gold, A. White, P.S. Brigaud, O. Battioni, P. Mansuy, D. (1992). *Inorg. Chem.*, 31, 2044.
- Mansuy, D. Momenteau, (1982). *M. Tetrahedron Lett.*, 2781.
- Martirosyan, G.G. Azizyan, A.S. Kurtikyan, T.S. Ford, P.C., (2004). *Chem. Commun.*, 1488.
- Matsuzaki, Y. Nogami, A. Tsuda, A. Osuka, A. Tanaka K., (2006). *J. Phys. Chem. A* ,110, 4888.
- McLaughlin, G.M. (1974). *J. Chem. Soc., Perkin Trans. 2*, 136.
- Medforth, C. J. Wang, Z. Martin, K. E. Song, Y. Jacobsenc, J. L. Shelnut, (2009). *J. A. Chem. Commun.*, 7261.
- Menotti, A. R. (1941). *J. Am. Chem. Soc.*, 63, 267.
- Meunier, B. (1992). *Chem. Rev.* , 92, 1411.
- Milgrom, L.R. (1997) *The Colours of Life*, OUP, Oxford,;
- Misawa, K. Kobayashi, T. (1999). *J. Chem. Phys.*, 110, 5844.
- Nahar, N. Tabata, M. (1998). *J. Porphyr. Phthalocyan.*, 2, 397.
- Nakanishi, I. Fukuzumi, S. Barbe, J.M. Guillard, R. Kadish, K.M. (2000). *Eur. J. Inorg.Chem.*, 1557.
- Napoli, M.D. Nardis, S. Paolesse, R. Graca, M. Vicente, H. Lauceri, R. Purrello, R. (2004). *J. Am. Chem. Soc.* 126, 5934.
- Nappa, M. J. S. Valentine, (1978). *J. Am. Chem. Soc.*, 100, 5075
- Nikiforov, M.P. Zerweck, U. Milde, P. Loppacher, C. Park, T.-H. Tetsuo Uyeda, H. Therien, M.J. Eng. L. Bonnell, D. (2008). *Nano Lett.*, 8,110.
- Nuesch, F.; Gratzel, M. (1995). *Chem. Phys.*, 193, 1.
- Ohmo, O. Kaizu, Y. Kobayashi, H. (1993). *J. Chem. Phys.* 99, 4128.
- Okada, S.; Segawa, H. (2003). *J. Am. Chem. Soc.*, 125, 2792.

- Pasternack, R. F. Schaefer, K. F. Hambright, P. (1994). *Inorg. Chem.*, 33, 2062.
- Pasternack, R.F. Gibbs, E.J. Antebi, A. Bassner, S. Depoy, L. Turner, D.H. Williams, A. Laplace, F. Lansard, M.H. Merienne, C. Perrée-Fauvet, M. (1985). *J. Am. Chem. Soc.*, 107, 8179.
- Perie, K. Barbe J.M., Cocolios P., (1996). *Soc. Chim. Fr.*, 133, 697.
- Porra, R.J. (1997) *Photochem. Photobiol.*, 65, 492.
- Prins, L. J. Reinhoudt, D. N. Timmerman, P., (2001). *Angew. Chem. Int. Ed.*, 40, 2382
- Ren, Q.G. Zhou, X.T. Ji, H.B. (2010). *Chin. J. Org. Chem.*, 30, 1605.
- Ribo, J. M. Crusats, J. Farrera, J. A. Valero, M. L. (1994). *J. Chem. Soc., Chem. Commun.*, 681.
- Robinson, L.R. Hambright, P. (1992). *Inorg. Chem.*, 31, 652.
- Rothmund, P. (1935). *J. Am. Chem. Soc.* 57, 2010.
- Rothmund, P. (1936). *J. Am. Chem. Soc.* 58, 625.
- Rotomskis, R. Augulis, R. Snitka, V. Valiokas, R. Liedberg, B. (2004). *J. Phys. Chem., B* 108, 2833.
- Rowan, A.E. Gerritsen, J.W. Nolte, R.J.M. Maan, J.C. (2004). *Nano Lett.*, 4, 1401.
- Rubio, M. Rios, B. O. Serrano-Andres, L. Merchan, M. (1999). *J. Chem. Phys.*, 110, 7202
- Sasaki, F. Kobayashi, (1993). *S. Appl. Phys. Lett.*, 63, 2887.
- Schauer, C.K. Anderson, O.P. Lavalley, D.K. Battioni J.-P. Mansuy, D. (1987). *J. Am. Chem. Soc.*, 109, 3922.
- Schenning, A.P.H.J. Meijer, E.W. (2005). *Chem. Commun.*, 3245.
- Scherz, A. Parson, W.W. (1984). *Biochim. Biophys. Acta*, 766, 653.
- Schouten, P. Warman, J. De Haas, M. Fox, M. Pan, H. (1991). *Nature*, 353, 736.
- Scolaro, L.M. Andrea Romeo, A. Pasternack, R.F., (2004). *J. Am. Chem. Soc.*, 126, 7178.
- Shah, B. Shears B. Hambright, P. (1971). *Inorg. Chem.*, 10, 1828.
- Shen, Y. Ryde, U. (2005). *Chem. Eur. J.*, 11 1549.
- Shimizu, Y. Taniguchi, K. Inada, Y. Funahashi, S. Tsuda, Y. Ito, Y. Inamo, M. Tanaka, M. (1992). *Bull. Chem. Soc. Jpn.*, 65, 771.
- Shirakawa, M. Kawano, S. Fujita, N. Sada, K. Shinkai, S. (2003). *J. Org. Chem.*, 68, 5037.
- Shundo, A. Labuta, J. Hill, J.P. Ishihara, S. Ariga, K., (2009). *J. Am. Chem. Soc.*, 131, 9494.
- Siskova, K. Vlckova, B. Mojzes, P. (2005). *J. Mol. Struct.* 744.
- Spano, F. C. Mukamel, (1989). *S. Phys. Rev. A*, 40, 5783.
- Spasojevic´ I., Batinic´-Haberle, (2001). *I. Inorg. Chim. Acta*, 317, 230.
- Stinson, C. Hambright, P. (1977). *J. Am. Chem. Soc.*, 99, 2357.
- Sudeep, P.K. Ipe, B.I. Thomas, K.G. George, M.V. Barazzouk, S. Hotchandai, S. Kamat, P.V. (2002). *Nano Lett.*, 2, 29.
- Tabata, M. Kajhara, N. (1989) *Anal. Sci.*, 5, 719.
- Tabata, M. Miyata, W. Nahar, N. (1995). *Inorg. Chem.*, 34, 6492.
- Tabata, M. Tanaka, M. (1985). *J. Chem. Soc., Chem. Commun.* 42.
- Tabata, M. Tanaka, M. (1988). *Inorg. Chem.*, 27, 203.
- Tabata, M. Tanaka, M. (1991). *Trends Anal. Chem.*, 10, 128.
- Tabata, M. Nishimoto, J. Kusano, K. (1998). *Talanta* 46, 703.
- Terazima, M. Shimizu, H. Osuka, A. (1997). *J. Appl. Phys.*, 81, 2946.
- Tong, Y. Hamilton, D.G. Meillon, J.-C. Sanders, J.K.M., (1999) *Org. Lett.*, 1, 1343.
- Tovmasyan, A.G. Babayan, N.S. Sahakyan, L.A. Shahkhatuni, A.G. Gasparyan G.H., Aroutiounian, R.M. Ghazaryan, R.K. (2008). *J. Porphyr. Phthalocya.*, 12, 1100.
- Tung, J.Y. Chen, J.-H. (2000). *Inorg. Chem.*, 39, 2120.

- Valicsek, Z. Horváth, O. (2007). *J. Photoch. Photobio. A*, 186, 1.
- Valicsek, Z. Horváth, O. Lendvay, G. Kikas, Skoric, I.I. (2011). *J. Photoch. Photobio. A*, 218, 143.
- Valicsek, Z. Lendvay, G. Horváth, O. (2008). *J. Phys. Chem. B*, 112, 14509.
- Valicsek, Z. Lendvay, G. Horváth, O. (2009). *J. Porphyr. Phthalocya.*, 13, 910.
- Van de Craats, A.M. Warman, J.M. (2001). *Adv. Mater.*, 12, 130.
- Van der Boom, T. Hayes, R.T. Zhao, Y. Bushard, P.J. Weiss, E.A. Wasielewski, M.R. (2002). *J. Am. Chem. Soc.* 124 9582.
- Waggoner, A. Membr. J. (1976). *Biol.*, 27, 317.
- Walker, V.E.J. Castillo, N. Matta, C.F. Boyd, R.J. (2010). *J. Phys. Chem. A.*, 114, 10315.
- Wang, M.-Y. R. Hoffman, B. M. (1984) *J. Am. Chem. Soc.*, 106, 4235.
- Wang, Y. (1986). *Chem. Phys. Lett.*, 126, 209.
- Wang, Y. (1991). *J. Opt. Soc. Am. B*, 8, 981.
- Watanabe, H. Ohmori, H. (1981). *Talanta* 28 774.
- West, W. Carroll, B. H. (1966). In *The Theory of Photographic Processes*, 3rd ed. James, T. H., Ed.; The McMillan Company: New York,; Chapter 12.
- Whitten, D. G. Lopp, I. G. Wildes, P. D. (1968). *J. Am. Chem. Soc.*, 90, 7196
- Wittmer, L.L. Holten, D. (1996), *J. Phys. Chem.*, 100, 860.
- Wittmer, L.L. Holten, D. (1996). *J. Phys. Chem.*, 100, 860.
- Xiangqing Li, Line Zhang, Jin Mu, (2007). *Colloids and Surfaces A: Physicochem. Eng. Aspects* ., 311, 187.
- Yagai, S. Seki, T. Karatsu, T. Kitamura, A. Wrthner, F. (2008). *Angew. Chem.*, 47, 3367.
- Yamamoto, S. Watarai, H. (2008). *J. Phys. Chem. C*, 112, 12417.
- Yang, R. Wang, K. Long, L. Xiao, D. Xiaohai Yang, X. Tan, W. (2002). *Anal. Chem.*, , 74, 1088.
- Yusmanov, V.E. Tominaga, T.T. Borissevich, L.E. Imasato, H. Tabak, M. (1996). *Magn. Reson. Imaging*, 14, 255.
- Zhang, Y. Yang, R. H. Liu, F. Li, K.A., (2004) *Anal. Chem.*, 76, 7336.
- Zhang, Y. Chen, P. Liu, M. (2008). *Chem. Eur. J.*, 14, 1793.
- Zhang, Y. Chen, P. Ma, Y. He, S. Liu, M. (2009). *ACS Appl. Mater. Interfaces*, 1, 2036.
- Zheng, W. Shan, N. Yu, L. Eang, X. (2008). *Dyes and Pigments* 77, 153.
- Zhou, H. Baldini, L. Hong, J. Wilson, A. J. Hamilton, A.D., (2006). *J. Am. Chem. Soc.*, 128, 2421.
- Zimmermann, J. Siggel, U. Fuhrhop, J.-H. Roder, B. (2003). *J. Phys. Chem. B* 107, 6019.

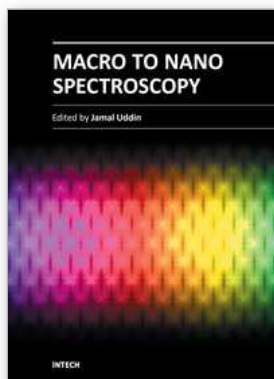

Macro To Nano Spectroscopy

Edited by Dr. Jamal Uddin

ISBN 978-953-51-0664-7

Hard cover, 448 pages

Publisher InTech

Published online 29, June, 2012

Published in print edition June, 2012

In the last few decades, Spectroscopy and its application dramatically diverted science in the direction of brand new era. This book reports on recent progress in spectroscopic technologies, theory and applications of advanced spectroscopy. In this book, we (INTECH publisher, editor and authors) have invested a lot of effort to include 20 most advanced spectroscopy chapters. We would like to invite all spectroscopy scientists to read and share the knowledge and contents of this book. The textbook is written by international scientists with expertise in Chemistry, Biochemistry, Physics, Biology and Nanotechnology many of which are active in research. We hope that the textbook will enhance the knowledge of scientists in the complexities of some spectroscopic approaches; it will stimulate both professionals and students to dedicate part of their future research in understanding relevant mechanisms and applications of chemistry, physics and material sciences.

How to reference

In order to correctly reference this scholarly work, feel free to copy and paste the following:

Rita Giovannetti (2012). The Use of Spectrophotometry UV-Vis for the Study of Porphyrins, Macro To Nano Spectroscopy, Dr. Jamal Uddin (Ed.), ISBN: 978-953-51-0664-7, InTech, Available from:
<http://www.intechopen.com/books/macro-to-nano-spectroscopy/the-use-of-spectrophotometry-uv-vis-for-the-study-of-porphyrins>

INTECH

open science | open minds

InTech Europe

University Campus STeP Ri
Slavka Krautzeka 83/A
51000 Rijeka, Croatia
Phone: +385 (51) 770 447
Fax: +385 (51) 686 166
www.intechopen.com

InTech China

Unit 405, Office Block, Hotel Equatorial Shanghai
No.65, Yan An Road (West), Shanghai, 200040, China
中国上海市延安西路65号上海国际贵都大饭店办公楼405单元
Phone: +86-21-62489820
Fax: +86-21-62489821

© 2012 The Author(s). Licensee IntechOpen. This is an open access article distributed under the terms of the [Creative Commons Attribution 3.0 License](#), which permits unrestricted use, distribution, and reproduction in any medium, provided the original work is properly cited.