

For consideration of publication in the *International Journal of Production Research*
Vol. 00, No. 00, January 2014, 1–26

Submitted for revision

The value of nonlinear control theory in investigating the underlying dynamics and resilience of a grocery supply chain

V. L. M. Spiegler^{a*}, A. T. Potter^b, M. M. Naim^b and D. R. Towill^b

^aOperations and Supply Chain Systems Group, Brunel Business School, Eastern Gateway Building,
Kingston Lane, Uxbridge, UB8 3PH;

^bLogistics Systems Dynamics Group, Cardiff Business School, Cardiff University, Aberconway Building,
Colum Drive, Cardiff, CF10 3EU

(Template v4.1 released January 2014)

In an empirical context, a method to use nonlinear control theory in the dynamic analysis of supply chain resilience is developed and tested. The method utilises block diagram development, transfer function formulation, describing function representation of nonlinearities and simulation. Using both ‘shock’ or step response and ‘filter’ or frequency response lenses, a system dynamics model is created to analyse the resilience performance of a distribution centre replenishment system at a large grocery retailer. Potential risks for the retailer’s resilience performance include the possibility of a mismatch between supply and demand, as well as serving the store inefficiently and causing on-shelf stockouts. Thus, resilience is determined by investigating the dynamic behaviour of stock and shipment responses. The method allows insights into the nonlinear system control structures that would not be evident using simulation alone, including a better understanding of the influence of control parameters on dynamic behaviour, the identification of inventory offsets potentially leading to ‘drift’, the impact of nonlinearities on supply chain performance and the minimisation of simulation experiments.

Keywords: Supply chain dynamics, nonlinear control theory, describing function, supply chain resilience

1. Introduction

Grocery retailers have modernised their supply chains in order to improve operational efficiencies. Over many years, this had led to the view that they are international leaders in supply chain management (Fernie 1992; Hingley *et al.* 2011). Since the 1980s, retail companies have integrated primary and secondary distribution to decrease lead-times and take inventory out of their supply chains (Potter *et al.* 2007). This logistical change has increased the importance of having an efficient and responsive replenishment system in distribution centres (DCs). According to Corsten and Gruen (2003), the “availability of products is the new battleground in the fast moving consumer goods industry”, therefore, on-shelf availability is a key performance indicator for the retail industry

*Corresponding author. Email: Virginia.Spiegler@brunel.ac.uk

and has great impact on profits and customer loyalty (Fernie and Sparks 2004; Aastrup and Kotzab 2009). Under these circumstances, the ability of a supply chain to be resilient is vital to sustain competitiveness (Pettit *et al.* 2010; Bhamra *et al.* 2011).

A system dynamics approach combining nonlinear control theory (NCT) and simulation modelling is applied to evaluate the resilience performance of a DC replenishment system at one of the largest grocery retailers in the UK. System dynamics play a significant role in supply chain performance. These dynamics are normally driven by the application of different control system policies and can be considered a source of supply chain disruption, depending on the control system design (Mason-Jones and Towill 1998; Christopher and Peck 2004; Colicchia *et al.* 2010). In the retail industry, 15% of retail out-of-stock issues occur due to problems in the DC replenishment control system (Corsten and Gruen 2003).

We aim to determine the methodological benefits of NCT in supporting simulation-based empirical research on supply chain resilience, with the context being the UK grocery industry. As Ivanov and Sokolov (2013) have emphasised, there is a need to further develop the research area of resilience and adaptation within the domains of supply chain dynamics analysis and control. It has also been argued that the use of simulation alone may lead to a time-consuming and unrewarding analysis process (Atherton 1975; Vukic *et al.* 2003).

In developing our approach, we employed a well-established framework proposed by Naim and Towill (1994) to design a supply chain system. Figure 1 illustrates the steps taken in our research process. There were two distinct but overlapping phases of analyses. In the qualitative phase, both the objective of the study and the key variables were identified through a visualisation and soft modelling process, that is, via the use of input-output and causal loop diagrams. The quantitative analysis, which encompassed the development and analysis of mathematical and simulation models. We will refer to this framework as we present the findings of the case study research in later sections.

This paper proceeds by reviewing the relevant literature on system dynamics, nonlinear systems and supply chain resilience. Next, the replenishment system of the retailer is discussed, leading to the formulation of mathematical and simulation models. These models are then analysed in detail, with particular focus on the resilience performance and the impact of inherent nonlinearities. We conclude by reflecting on the implications of utilising NCT with simulations versus using the simulations alone.

2. Literature Review

2.1 *Supply chain dynamics and nonlinear systems*

Forrester's (1958) work on industrial dynamics calls attention to the importance of considering nonlinear models to represent industrial and social processes. "Nonlinearity can introduce unexpected behaviour in a system" (Forrester 1968), causing instability and uncertainty. Despite this, most studies of supply chain dynamics that use mathematical modelling focus on 'presumably' linear models (e.g. Towill 1982; John *et al.* 1994; Disney and Towill 2005; Gaalman and Disney 2009; Zhou *et al.* 2010), which greatly limits the applicability of published results (Wang *et al.* 2014). To maintain linearity in production and inventory control systems, previous studies assume that order rates can take negative values, shipments to customers can occur even when there is no holding inventory, no batching is considered in the material flow and the system has unlimited capacity.

With the advance of computer technology, most of the recent research about nonlinear supply chain models has been undertaken through computer simulation (Table 1). This research has led to the understanding of particular phenomena, such as:

- stability and chaos (Larsen *et al.* 1999; Laugesen and Mosekilde 2006),
- the impact of capacity and batching constraints (e.g. de Souza *et al.* 2000; Paik and Bagchi 2007; Cannella *et al.* 2008; Juntunen and Juga 2009; Hamdouch 2011; Ivanov *et al.* 2014a)

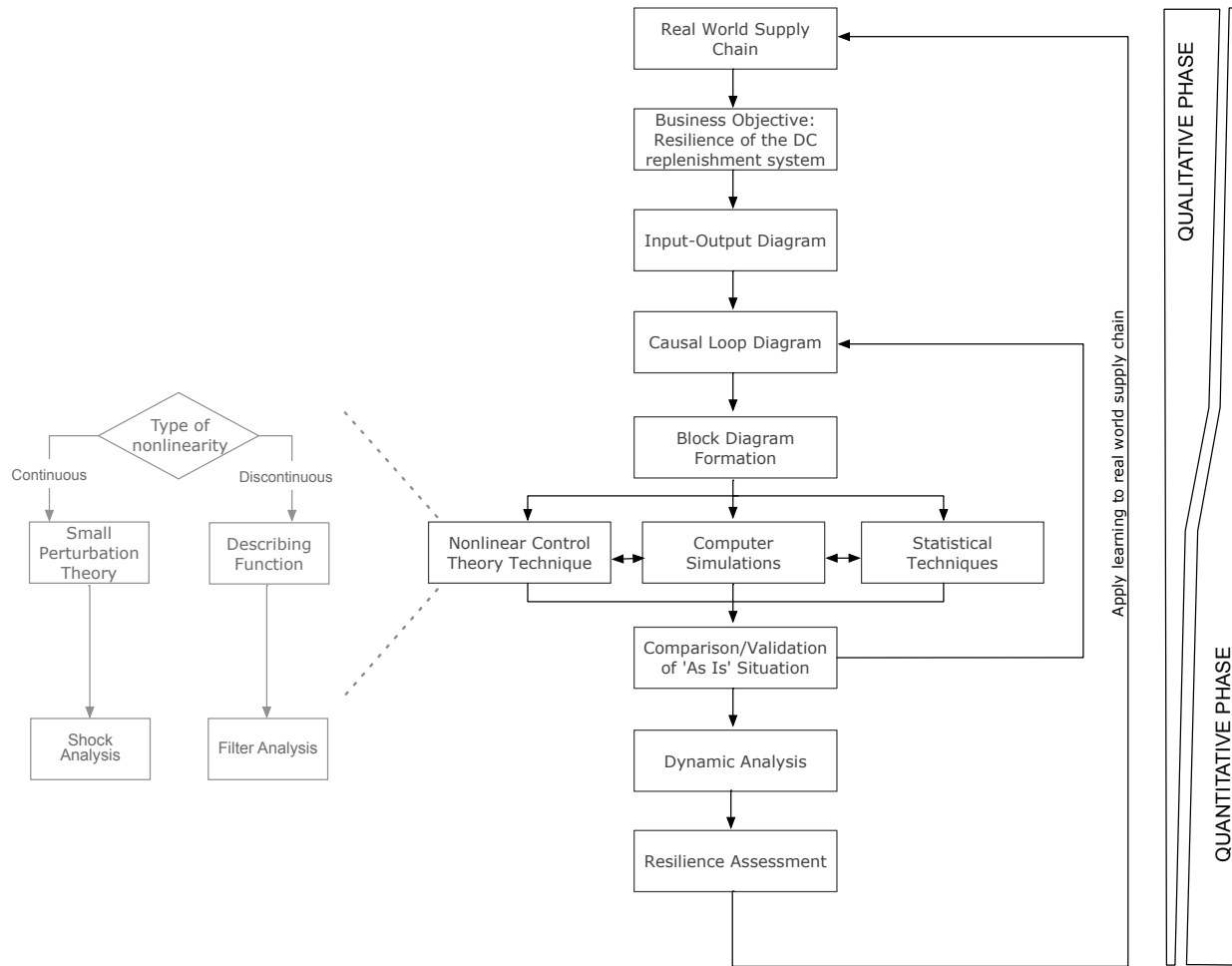

Figure 1. Framework to design resilient supply chains
Adapted from Naim and Towill (1994)

and collaborative strategies (e.g. Cannella and Ciancimino 2010; Spiegler and Naim 2014) on system dynamics and supply chain performance,

- shipment planning (Shukla *et al.* 2009; Mula *et al.* 2013) and
- the effects of psychological pressure, misperceptions and misjudgement in work environments (Sterman 1989; Syntetos *et al.* 2011; Bruccoleri *et al.* 2014).

However, engineering and mathematics experts have made advances in NCT and, despite this still being an area for debate, new tools and techniques to deal with high-order, nonlinear systems with multiple loops have been developed (Karafyllis and Jiang 2011). Despite many analytical methods being cited and recommended by system dynamics scholars over 30 years ago (Mohapatra 1980) and lately by Saleh *et al.* (2010), there are few applications of such methods. Notable exceptions are Jeong *et al.* (2000), Wang and Disney (2012) and Wang *et al.* (2014).

Jeong *et al.* (2000) applied the Matsubara time delay theorem and small perturbation theory to find a state-space representation of three echelons in a variant form of the Forrester model. Despite efforts to linearise part of the model, they use only simulation methods to analyse the effect of different capacity levels on the factory's production rate, unfilled orders and design decision rules so that the supply chain achieves a stable response when the system saturates, that is, reaches capacity. Wang and Disney (2012) and Wang *et al.* (2014) used eigenvalue methods to explore the stability boundaries of a piecewise linear inventory control system and identify a set of behaviours in the unstable region. Their work is limited to the analysis of a single-valued discontinuous nonlinearity given by a non-negative constraint on the replenishment order. In this

Table 1. Analysis of nonlinear supply chain systems and scope of this research

Author	Method of analysis		Supply chain application	Key findings
	NCT	Simulation		
Sterman (1989)		✓	Investigation of misperceptions of time delays and feedback loops via a tabletop management simulator, the Beer Game	Dynamic distortions and amplification in a supply chain are also caused by human misperceptions about inventory and demand information
Larsen <i>et al.</i> (1999); Laugesen and Mosekilde (2006)		✓	Shaping stability regions of the Beer Game	The influence of different inventory control policies upon dynamics and costs are discussed
Shukla <i>et al.</i> (2009)		✓	Backlash, or shipment profile, analysis of the Beer Game	The backlash effect is a reflection of the bullwhip effect, analogous to physical waveforms in a channel or pipe and can lead to high transport costs due to inefficient scheduling and premium transport rates
de Souza <i>et al.</i> (2000); Paik and Bagchi (2007); Cannella <i>et al.</i> (2008); Juntunen and Juga (2009); Shukla <i>et al.</i> (2009); Cannella and Ciancimino (2010); Hamdouch (2011); Spiegler and Naim (2014); Ivanov <i>et al.</i> (2014a)*		✓	Effect of capacity and batching constraints and collaborative strategies on production operations, customer service and financial performance	Capacity and batching constraints can result in complex behaviour and create secondary dynamics in the system. Collaboration can help in mitigating such behaviour
Syntetos <i>et al.</i> (2011)		✓	Analysis of judgemental adjustments by managers on the demand forecasting process and replenishment orders	Judgemental interventions may have a substantially adverse effect on supply chain performance
Mula <i>et al.</i> (2013)		✓	Developing simulation models to quantify the trade-off between the number of truck shipments and inventory level	Integrating simulation models with MRP systems can help companies improve their transport planning practices and better meet customer needs
Bruccoleri <i>et al.</i> (2014)		✓	Designing order and inventory policies taking into account workers' behavioural reactions to work pressure	Order and inventory variances are affected by the psychological stability and workload pressure of workers
Jeong <i>et al.</i> (2000)	✓	✓	Use of small perturbation theory to linearise Forrester's model and conduct robust control of supply chain decision rules	Potential for a control algorithm, consisting of state feedback and filtering with an integral controller, in achieving a stable response when the system saturates
Wang and Disney (2012)	✓	✓	Eigenvalue and Lyapunov-based stability analysis of a nonlinear production and inventory system	A complex and diversified set of behaviours and patterns identified in the asymptotically unstable region
Wang <i>et al.</i> (2014)	✓	✓	Eigenvalue analysis of a nonlinear production and inventory system	Different classes of dynamic behaviour identified
This paper	✓	✓	Use of describing function method to analyse non-negative batching constraints and backlog situation	We aim to gain better understanding of the influence of control parameters on nonlinear dynamic behaviour

*Ivanov *et al.* (2014a) combine optimal control theory with optimisation methods in a numerical experiment setting

paper, we use the describing function method to analyse both single- and multi-valued nonlinearities given by non-negative batching constraints in the ordering rule and backlog situations in the shipment estimation. Moreover, our work focuses on understanding behaviour within the system's stable region and proposing system redesign.

2.2 Supply chain resilience and dynamics

The idea of resilience has emerged in the supply chain literature in recent years (Christopher and Peck 2004; Sheffi and Rice 2005) and is defined as “the adaptive capability of the supply chain to prepare for unexpected events, respond to disruptions, and recover from them by maintaining continuity of operations at desired levels of connectedness and control over structure and function” (Ponomarov and Holcomb 2009). This definition implies achieving three properties: readiness (being prepared or available for service), response (reaction to a specific stimulus) and recovery (a return to ‘normal’ stable or steady state conditions). By combining all attributes of typical system dynamics responses with the three resilience properties, Spiegler *et al.* (2012) demonstrated that when the region between the system’s actual response and the target level is minimised, as highlighted in Figure 2, then supply chain resilience is improved. This follows the same reasoning as minimising the resilient triangle (Tierney and Bruneau 2007; Zobel and Khansa 2011); however in Spiegler *et al.* (2012) approach, it is considered that the output may overshoot and/or undershoot before recovering, thus not assuming a triangular shape but some form of oscillatory behaviour, which is typical of dynamic systems.

The body of knowledge relating to supply chain resilience is still in its infancy, and research findings are fragmented across the literature (Blackhurst *et al.* 2011). Most existing studies in this area are qualitative in nature, with the preferred methods being theory building and case studies (Bhamra *et al.* 2011). Moreover, the focus has been on identifying sources of risks and on determining mitigation and contingency strategies (Spiegler *et al.* 2012). In a systematic literature review, Pereira *et al.* (2014) identified the need to analyse trade-offs occurring between intra-organisational issues, such as internal communication, inventory, product flexibility and information technology, and inter-organisational issues, such as strategic sourcing, supply chain design and re-engineering, transportation and risk monitoring to improve supply chain resilience. Using case studies, Alblas and Jayaram (2015) identified different types of flexibility and design resilience measures that help in clustering practices and in planning resilient organisations. However, quantitative approaches to assess different resilience strategies are limited.

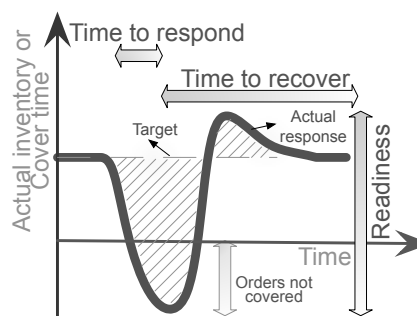

Figure 2. Assessing supply chain resilience: readiness, response and recovery
Source: Spiegler *et al.* (2012)

There is a need for more systematic examinations of supply chain dynamics and control for planning resilience and adaptation strategies (Ivanov and Sokolov 2013) as the literature contains only a few studies that applied a system dynamics research method in studying resilience. For instance, Wilson (2007) analysed the impact caused by disruptions in transport processes on customer service, inventory and goods in transit and evaluated how a more collaborative supply chain, such as vendor-managed inventory, can help to overcome these disruptions. Spiegler *et al.* (2012) investigated how different control policies and system dynamics in supply chains affect the readiness, response and recovery of inventory and shipments, which are performance indicators of demand and supply matching. Their study also evidenced a trade-off between production cost and resilience design. Ivanov and Sokolov (2013) proposed general mathematical formulations for analysing stability, robustness and resilience within a supply chain dynamics and control framework. The same

methodology has been applied by Ivanov *et al.* (2014b) to model the effects of disruption propagated through the supply chain and recommended suitable methods for mitigating this ‘ripple effect’. However, all these works are either conceptual or exploratory and have limited empirical data.

In this study, we focus on the operational supply chain performance and potential risks of mismatching supply and demand. Therefore, we extend the Spiegler *et al.* (2012) analytical framework by assessing the supply chain resilience of a grocery retailer. In this way, we also supplement the literature with empirical data. Moreover, we explore alternative analytical methods as simulation is the predominant method for quantitative analysis of system dynamics, despite its limitations.

3. Empirical model formulation and validation

In this section, we explain our research process from a real-world situation through data capture, modelling and validation, as illustrated in Figure 1. Dynamic analysis, resilience assessment and redesign recommendations will be presented in Section 4. The research in this paper was carried out in conjunction with a major UK grocery retailer, with the aim of examining the resilience of its DC replenishment system. The purpose was to suggest improvements to the system, although the underlying structure could not be adjusted.

To construct the model, a number of interviews were conducted with the manager responsible for the DC replenishment system we focus on in this study. This led to the conceptualisation of the system through input-output and causal loop diagrams (Appendix A). The replenishment rules were determined during the course of the interviews and were then converted into a block diagram in the Laplace domain, ‘ s ’, as given in Figure 3.

In order to satisfy the Orders from Store (OS), the DC replenishment order calculation is based on an order-up-to system. Each order takes into account both the time until the order is generated plus the time until the next order is delivered. The raw order quantity (*ROQ*) is calculated from the following elements:

- Demand forecasting policy

$$\text{Forecast demand}(s) = (D_A + D_B) \frac{OS(s)}{1 + T_a \cdot s}, \quad (1)$$

where D_A is the percentage of the store demand that occurs during the review time (Period A), D_B is the percentage of the store demand that occurs during the delivery lead-time (Period B) and the parameter T_a is used to represent the exponential smoothing function with $\alpha = \frac{1}{\Delta t(1+T_a)}$ and is normally set equal to 2 by the DC.

- Stock error

$$\text{Stock error}(s) = \text{Safety Stock}(s) - \text{Stock}(s) + \text{Backlog}(s), \quad (2)$$

where $\text{Safety Stock}(s) = K(\frac{1}{2}D_A + D_B)\text{Forecast weekly demand}(s)$ and K is the service level determinant.

- Actual Goods in Transit (GIT)

$$\text{GIT}(s) = \frac{1}{s}(\text{Supplier Order}(s) - \text{Delivery}(s)). \quad (3)$$

In the ‘As Is’ scenario, which describes the current situation in the DC replenishment system, a target *GIT* is not specified. In other words, it is currently being set equal to zero.

However, for designing reasons we have included this target in the block diagram of Figure 3. A parameter T_i has also been included in the block diagram representation to represent the time actual and safety stocks takes to balance. In the ‘As Is’ scenario this is set equal to 1 by the DC. Hence the ROQ is finally given by:

$$ROQ(s) = Forecast\ demand(s) + \frac{Stock\ error(s)}{T_i} + (target\ GIT - GIT(s)). \quad (4)$$

Once the *ROQ* has been calculated, a *ROUNDING* function is imposed on the order, based on the *Buying Quantity* and *Truckload Constraint*. The former ensures that the system orders in unit loads. In most cases, this equates to a full pallet. This rounding helps reduce warehousing costs. In imposing the *Truckload Constraint*, all orders with the same origin and destination are grouped together. The volume of goods is then compared against the capacity of the vehicles used on that route. Therefore, the amount of rounding for each product may vary. Moreover, in the rounding process, orders can never assume negative values, which means that goods are never returned to suppliers. When determining the shipments to the store, the *CLIP* function denotes that shipments will depend upon stock levels and deliveries from suppliers. When the shipments are not equal to the *OS*, then a backlog builds up. Therefore, the desired shipment in the next replenishment period will be *OS* plus any backlog. The presence of the *CLIP* and *ROUNDING* functions makes the model nonlinear.

Mathematical and simulation models were created from the block diagram representation with the aim of building a simple but credible representation of the real system. The mathematical model is given by transfer function formulations and piecewise linear equations formulated later for the nonlinear analysis. This model is continuous in time, and the delay caused by the delivery lead-time (T_p) is implemented as a first order delay. A spreadsheet simulation model (Appendix B) was also developed so that the model could be easily understood by retailer staff. This model is discrete in time and the delay is implemented as pure lag. Although results between discrete and continuous time modelling may differ, it can be argued that the management insights gained from both time approaches are very similar and that their qualitative natures are essentially the same (Disney *et al.* 2006; Warburton and Disney 2007).

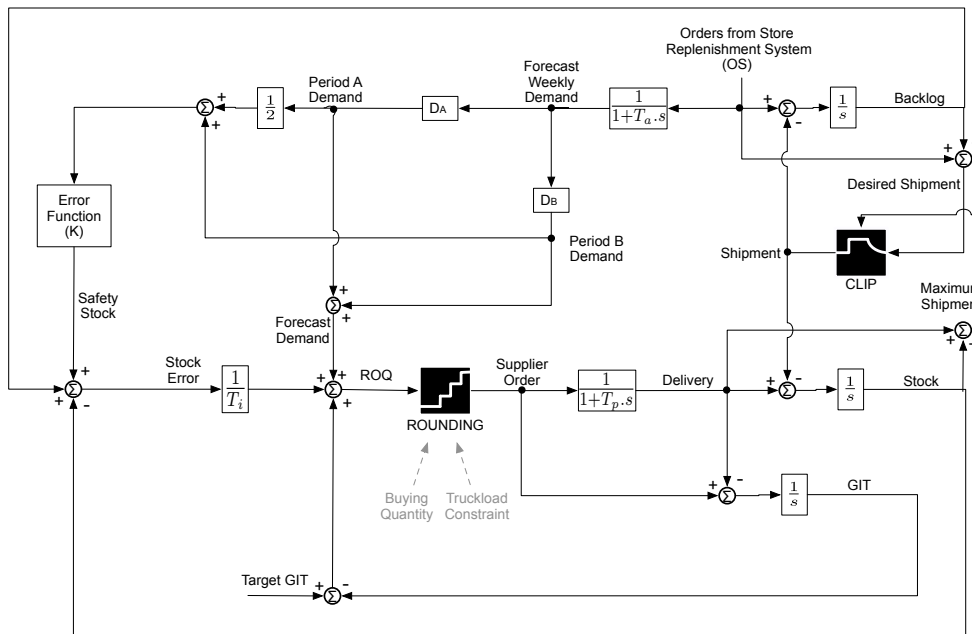

Figure 3. Block diagram of the DC replenishment system

As noted by Bailey (1994), a model is a simplification of reality and can provide a good representation of the system under study. Therefore, there are a number of assumptions in our mathematical and simulation models:

- Store replenishment orders are aggregated, rather than being placed on a store-by-store basis. This simplifies the mathematical model and speeds up the simulation run time.
- Only a single generic product is modelled. Although this assumption is usually made in inventory theory, it has some implications in terms of the *Truckload Constraint*. Thus, in this study the rounding effect will consider a single product group.
- All supplier deliveries are made in full when compared with the ordered volume. That means that the order is received 100% complete with no missing products. This does not fully reflect the real supply chain where some deliveries will be incomplete. However, this does not happen often as penalties are imposed by retailers (Blythman 2004; Groceries Code Adjudicator 2014). Therefore, under normal operating conditions, this assumption is realistic and has been adopted by other system dynamics scholars investigating replenishment control systems (e.g. Disney and Towill 2005; Shukla *et al.* 2009; Cannella and Ciancimino 2010; Spiegler and Naim 2014).

Limitations of the simulation model arise when these assumptions are not met. In the mathematical model, approximations will be made in the linearisation process in order to gain insights into the model's dynamic behaviour analytically. However, simulation will be used to cross-check the findings.

Having developed the mathematical and simulation models, the next stage was to verify and validate the findings. This is an important step in assuring accuracy of the model (Sargent 2013). Using Table 2 as reference, a number of tests and sensitivity analyses were carried out to verify the model structure and behaviour. First, the model was verified by talking the system manager through the equations entered into the spreadsheet. Next, tests using extreme input and parameter values and eliminating assumptions were undertaken. The mathematical model, given by transfer function formulation, piecewise linear equations and the block diagram in Figure 3, was also tested using Wolfram MathematicaTM and MatlabTM/SimulinkTM in parallel with the spreadsheet simulation to crosscheck the results.

Table 2. Model Validation and Verification Tests - Adapted from Sterman (1984)

	Test used	Questions addressed by test	How tackled in this research
VERIFICATION	Structure	Consistent with system description?	Detailed feedback of model to interviewee to confirm accuracy.
	Parameters	Consistent with system data and description?	Comparison of simulation model performance to real world data.
	Extremities	Does every equation make sense even with extreme values?	Parameter values varied in increments to extreme values to check for consistent changes.
	Boundaries	Are all important factors included?	Importance of factors and nature of assumptions agreed with retailer.
	Dimensionality	Are all equations dimensionally consistent?	Daily time increments throughout and cases as smallest unit.
VALIDATION	Behaviour Reproduction	Can all behavioural characteristics of real system be generated?	Comparison of simulation model performance to real world data.
	Behaviour Anomalies	Are there anomalies if one model assumption is deleted?	Increasing the range of demand variability to account for peaks and weather changes still produced a consistent response.
	Family Member	Does the model reproduce behaviour observed in cognate systems?	Performance attributes consistent with those of generic models.

Finally, actual data used for validation were the actual system parameters, the sales data and the supplier orders. The sales data from three different products were used to generate stochastic demand signals. All three products have lead-time $T_p = 2$ days, smoothing time constant $T_a = 2$ days, service level determinant $K = 2.58$ (for a stock availability figure of 99%), *Buying Quantity* = 1 pallet (65 cases) and *Truckload Constraint* = 1 pallet. T_p is the only non-controllable parameter

because it represents a physical delay between the store and the DC. All the other parameters are controllers set by the DC replenishment system manager.

Table 3 presents the results of this validation process. The average and standard deviation values of the 3 products were used to create a stochastic input signal. Next, the variances of the DC *Supplier Order* outputted from the model were compared with the real world data. The simulation model appears to represent the response of the empirical system upon which it is derived well, especially for products with high average demand and lower standard deviations. For instance, for Product 1 the percentage difference between the real and model output data is very small.

In this validation process, we assumed the following characteristics of the data collected:

- Products are sold on an everyday low price basis with no promotions. This is consistent with the retailer’s policy for the products tested. Promotions would provoke distortion in the demand data and would interfere with our validation process, where a normally distributed demand pattern was assumed.
- The products’ demand is unaffected by unpredictable external factors such as the weather. Therefore, any manual adjustments in the forecast were not taken into account. These may negatively affect the validation process because we would not be able to differentiate between normal demand and weather-boosted demand. As indicated in Table 2, other stages of the validation process address these assumptions.

Table 3. Numerical validation of the DC replenishment system model

		Product 1	Product 2	Product 3
Input signal	Average real world demand (cases per week)	10,320	8,547	2,563
	Standard deviation of demand (as % of demand)	0.186	0.250	0.325
Output signal		Variances in Supplier Order		
	Real world data	522,684	339,147	41,863
	Model data	513,406	393,214	49,866
	Percentage difference between real and model data	-1.7%	+15.9%	+19.1%

4. Resilience performance analysis

In this section, analysis of the DC replenishment system’s resilience performance is undertaken. To analyse the resilience performance of the DC replenishment system, we chose to combine NCT and system dynamics simulation methods. Although statistical techniques are depicted in our research framework in Figure 1, stochastic inputs and basic statistical analysis were used only to validate the model, as explained in the previous section.

When confronted with a nonlinear system, the primary approach is to classify the nonlinearities in order to identify appropriate analytical methods. In Figure 1, we show that for continuous nonlinearities, small perturbation theory can be applied. This method enables the system to be examined through successive approximations in the form of power series in the perturbation parameter. To investigate discontinuous nonlinearities, the describing function method, a quasi-linearisation technique, is applied. After linearisation, we can estimate the effect of ‘shock’ and ‘filter’ input signals (Towill *et al.* 2007) on the performance of this nonlinear system using linear control techniques.

When analysing system dynamics replenishment models via the ‘shock lens’ or step input analysis (Towill *et al.* 2007), readiness can be illustrated by the vertical displacement of the inventory response (refer to Figure 2). The smaller the vertical displacement is, the more prepared or available for service the supply chain may be said to be. Response and recovery can be measured by the time it takes for the inventory to recover target levels. According to Spiegler *et al.* (2012), resilience can then be obtained by designing systems in which the integral of time multiplied by the absolute value of the error (*ITAE*) between target and actual inventory responses is minimised.

On the other hand, when analysing system dynamics models via the ‘filter lens’, or sinusoidal input in response to recurring peak demand (Towill *et al.* 2007), the natural frequency (ω_n) and damping ratio (ζ) can be utilised. The former determines how fast the system’s output oscillates during the transient response, while the latter describes how oscillations in the system decay with time (Nise 2000). A resilient system will require a fast response and recovery of the inventory response while avoiding high oscillations. We will illustrate the effect of ω_n and ζ in our analysis and specifically in Sections 4.2 and 4.3.

4.1 Analysis via the ‘shock’ lens

In the case of the DC replenishment system, no continuous nonlinearities were found. Therefore, to analyse the model via the ‘shock lens’, we assume that the discontinuous nonlinearities are inactive. In other words, we assume the system is operating under ideal conditions. We will see later in Section 4.2 that for a certain range of demand amplitudes and frequencies, the system does not reach these capacity constraints and thus behaves linearly. Also, this preliminary analysis will help us to understand the basic underlying system structure prior to undertaking nonlinear analysis.

Under ideal operating conditions, a backlog situation would not occur and therefore shipments to the store would be made in full every period. Moreover, if *Buying Quantity* and *Truckload Constraints* could be overcome when trying to seek ‘batch of one’ operations, then nonlinearities in the model in Figure 3 could be eliminated. Therefore, under linear conditions we find that the transfer functions for the *Supplier Order*, *Stock* and *GIT* are respectively:

$$\frac{SupplierOrder}{OS} = \frac{1 + s(K + T_a + T_i + T_p) + s^2(K + T_a + T_i)T_p}{(1 + sT_a)[1 + s(T_iT_p + T_i) + s^2T_iT_p]}, \quad (5)$$

$$\frac{Stock}{OS} = \frac{K - T_iT_p + s(-T_aT_iT_p - T_aT_i - T_iT_p) - s^2T_aT_iT_p}{(1 + sT_a)[1 + s(T_iT_p + T_i) + s^2T_iT_p]}, \quad (6)$$

$$\frac{GIT}{OS} = \frac{(1 + s(K + T_a + T_i))T_p}{(1 + sT_a)[1 + s(T_iT_p + T_i) + s^2T_iT_p]}. \quad (7)$$

Initial and final value theorems are used to determine how the outputs will respond to a step change in the input. Table 4 presents the results for the final values of *Supplier Order*, *Stock* and *GIT* when *OS* undergoes a unit step change (from 0 to 1 unit). The initial values of all responses are zero, including their target initial values.

Table 4. Results from the Final Value Theorem

Response	Final value	Target final value
Supplier Order	1	1
Stock	$K - T_iT_p$	K
GIT	T_p	0

The results in Table 4 demonstrate that there is a permanent offset occurring in both *Stock* and *GIT* responses. The negative stock offset has a significant impact on the resilience performance because the system has been designed in such way that stock levels will never recover from changes in the orders received from the store. There may also be impacts on stock holding or customer service levels (Disney and Towill 2005). The company had not recognised this problem until the analysis was undertaken as no systematic control theory-based approach was previously utilised,

and the system algorithms had only ever been tested with ‘real world’ stochastic orders received from the stores.

The reason the drift occurs is found when investigating the model further. The target GIT should never be set to zero because the pipeline always exists due to non-zero lead-times. Moreover, the target GIT should not be fixed since it depends on OS . Therefore, a proposed solution for the target GIT is to make it variable as a function of both demand and lead-time, assuming that lead-time is always known or at least estimated. In the empirical environment studied, suppliers are given consistent two-day delivery lead-times and therefore this is a reasonable assumption.

In order to calculate the ITAE of the *Stock* response, the error between the safety and actual inventories is needed. Because of the existing drift, this error will lead to an infinite ITAE index. Instead, the final value of *Stock* given in Table 4 can be used as to estimate which parameter values would increase the system’s readiness and decrease the response and recovery times. From Equation 6, a fraction expansion method can be used to determine the time function for the *Stock*. In this way, ITAE can be estimated as:

$$\begin{aligned} ITAE &= \int_0^{\infty} t.|e(t)| dt = \int_0^{\infty} t.|K - T_i T_p - Stock(t)| dt = \\ &= K T_a^2 - T_i^3 T_p (1 + T_p)^2 + T_i (T_a^2 - K T_p + K T_a (1 + T_p)) + T_i^2 (T_p + 2 T_p^2 + T_a (1 + T_p) \\ &\quad + K (1 + T_p)^2). \end{aligned} \quad (8)$$

Note that Equation 8 is only valid for $T_a > 0$ and $K > T_i T_p$. It is also assumed that after the step change, the stock level drops and recovers without overshooting again. Therefore, Equation 8 should be used only for exploratory analysis before undertaking simulation. By fixing K with a considerably high value (enough to maintain $K > T_i T_p$ as true), Equation 8 shows that ITAE can be minimised; thus resilience can be maximised by decreasing T_i , T_a and T_p .

4.2 Analysis via the ‘filter’ lens

When considering the ROUNDING nonlinearity active in the ordering process, the system will behave as in Figure 4 when assuming open loop control and a sinusoidal input for ROQ such that

$$ROQ(t) = A \cos(\omega t) + B, \quad (9)$$

where ω is the angular frequency, A is the amplitude and B is the mean. The nonlinearity will produce an output, *Supplier Order*, of the same frequency and phase but different amplitude and mean. Each step in the output response corresponds to a *Buying Quantity* combined with a *Truckload Constraint*. Additionally, by clipping the output signal at its lower limit, the output response is never allowed to reach negative values.

Although *Supplier Order* function is nonlinear, it can be represented by multiple piecewise linear equations. In order to ease calculation, we can simplify this equation using a best fit or quantised approximation (Atherton 1975) to yield a piecewise linear representation with only two pieces:

$$SupplierOrder(t) = \begin{cases} ROQ(t), & \text{if } -\gamma < \omega t < \gamma \\ 0, & \text{if } -\pi < \omega t < -\gamma \text{ and } \gamma < \omega t < \pi. \end{cases} \quad (10)$$

Given ROQ as a sinusoidal input, the output *SupplierOrder* can be approximated to:

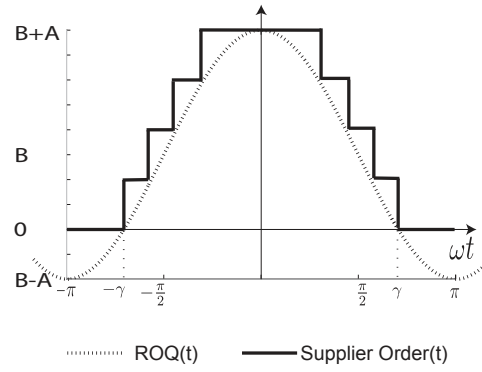

Figure 4. Asymmetric output saturations observed via the ‘filter’ lens

$$SupplierOrder(t) \approx N_A A \cos(\omega t + \phi) + N_B B, \quad (11)$$

where ϕ , N_A and N_B are the phase angle, the gains in amplitude and the mean, respectively. For the describing function analysis, only N_A is needed. In order to determine N_A , we need to expand the series and determine its first harmonic coefficients. The Fourier series expansion method is used to represent the output as a series, such as:

$$SupplierOrder(t) \approx b_0 + \sum_{k=1}^{\infty} [a_k \cos(k.\omega t) + b_k \sin(k.\omega t)], \quad (12)$$

where a_k , b_k and b_0 are the Fourier coefficients.

For the describing function, only the first, or fundamental harmonic is usually used to approximate the periodic series. If we approximate the piecewise linear output *Supplier Order* to the first harmonic, we have:

$$SupplierOrder(t) = b_0 + a_1 \cos(\omega t) + b_1 \sin(\omega t) = b_0 + \sqrt{a_1^2 + b_1^2} \cos(\omega t + \phi), \quad (13)$$

where, $\phi = \arctan(\frac{b_1}{a_1})$.

In this way, we can define the describing function gain as:

$$N_A = \frac{\sqrt{a_1^2 + b_1^2}}{A}. \quad (14)$$

For single-valued nonlinearities, the coefficient b_1 , the imaginary part of the describing function, will be equal to zero and therefore the phase angle will also be zero. Therefore, we find that:

$$N_A = \frac{\gamma - \cos(\gamma) \sin(\gamma)}{\pi}, \quad (15)$$

where $\gamma = \cos^{-1}(\frac{-B}{A})$.

Figure 5 illustrates how the coefficients of the describing function vary as the amplitude of the *ROQ* increases. For amplitudes lower than the mean B , the system behaves linearly and *Supplier Order* will be equal to the input *ROQ* corresponding to an N_A equal to 1. However, when the

amplitude of ROQ increases, only a fraction of this rate will actually be ordered. By inspecting Equation 15, we find that as the amplitude of ROQ approaches infinity, N_A approaches 0.5. So, the gain of the describing function can only vary from 0.5 to 1.

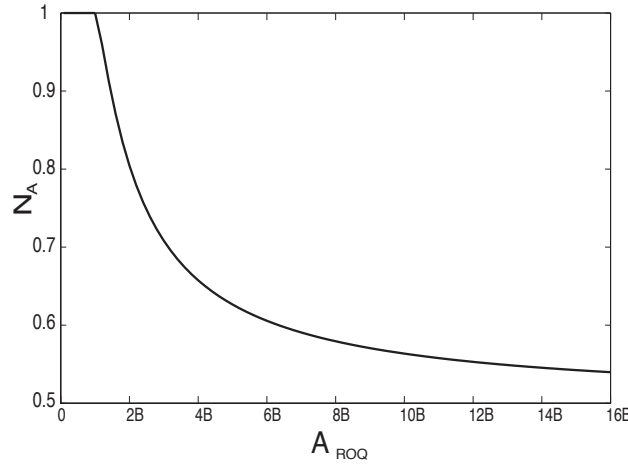

Figure 5. Describing function gain caused by the ROUNDING function

The second nonlinearity in the model is the CLIP function in the shipment system, which is used to avoid any shipments being made to the store if no stock is available. While in the ROUNDING function all constraints, *Buying Quantity*, *Truckload Constraint* and non-negative orders, were fixed, in the CLIP function the constraint is given by current responses of DC stock and delivery, which vary over time. Because of that, this nonlinearity is not only amplitude-dependent but also frequency-dependent. Therefore, there will be one describing function for each frequency. MatlabTM and SimulinkTM have been used to automate calculations and find the describing function gains for a set of amplitudes and frequency, resulting in Figure 6. The shaded areas indicate that N_A is below 1 and thus the system behaves nonlinearly. In contrast, the unshaded areas indicate the input frequencies and amplitudes for which the system behaves in a linear fashion. It should be noted that there is a not so obvious unshaded region for which the system has linear behaviour. That is, where ω approaches zero N_A approaches 1.

Although each nonlinearity in the DC replenishment system has different features, they both decrease their respective output gains, whose value, as per inspection of Equation 15 for the ROQ and Figure 6 for the shipment, is always between 0.5 and 1 and is a consequence of the asymmetry of the nonlinearities. Root locus techniques can be used to predict how these nonlinearities affect the system responses and the resilience performance. By replacing the ROUNDING and CLIP functions with the gains $N_{A(ROQ)}$ and $N_{A(Ship)}$, respectively, and using block diagram algebra, we again find that the new system characteristic equation is equal to:

$$(1 + s.T_a)[N_{A(ROQ)} + s(N_{A(ROQ)}.T_i.T_p + T_i) + s^2T_i.T_p] = 0. \quad (16)$$

In this way, the effect of the change in gains on ω_n and ζ can be calculated as:

$$\omega_n = \sqrt{\frac{N_{A(ROQ)}}{T_i T_p}} \quad (17)$$

$$\zeta = \frac{(1 + N_{A(ROQ)}.T_p)T_i}{2N_{A(ROQ)}} \sqrt{\frac{N_{A(ROQ)}}{T_i T_p}}. \quad (18)$$

In interrogating Equations 17 and 18, we find that a decrease in $N_{A(ROQ)}$ will result in a reduction in ω_n . ζ , which determines the degree of damping in the system, also decreases when $N_{A(ROQ)}$ decreases, although not to the same degree as ω_n . When substituting the actual parameter values used in the DC replenishment system, we find that ζ decreases from 1.06 to 1 when $N_{A(ROQ)}$ decreases from 1 to 0.5. Thus, the responses switch from an overdamped, or slow decay of oscillations, to critically damped. T_i can also be adjusted in order to achieve responses which ideally have a $\zeta = 0.7$ (Nise 2000). In Section 4.3, we will illustrate what these changes in ω_n and ζ mean for supply chain resilience.

Note that the CLIP function, whose describing function gain is $N_{A(Ship.)}$, has no effect on either ω_n or ζ . Thus, it does not influence the DC stock and Supplier Order responses. However, this nonlinearity has an impact on the shipment response. When the CLIP nonlinearity takes effect, it means that the DC Backlog is no longer zero, shipments to customers will be cut and the supply chain will be less resilient.

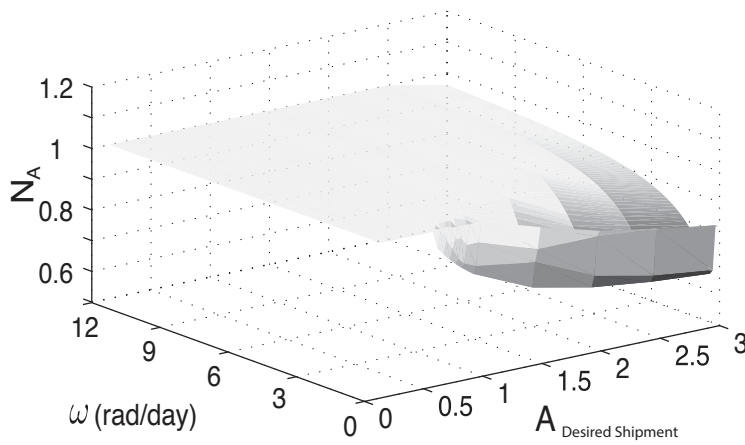

(a) 3D plot

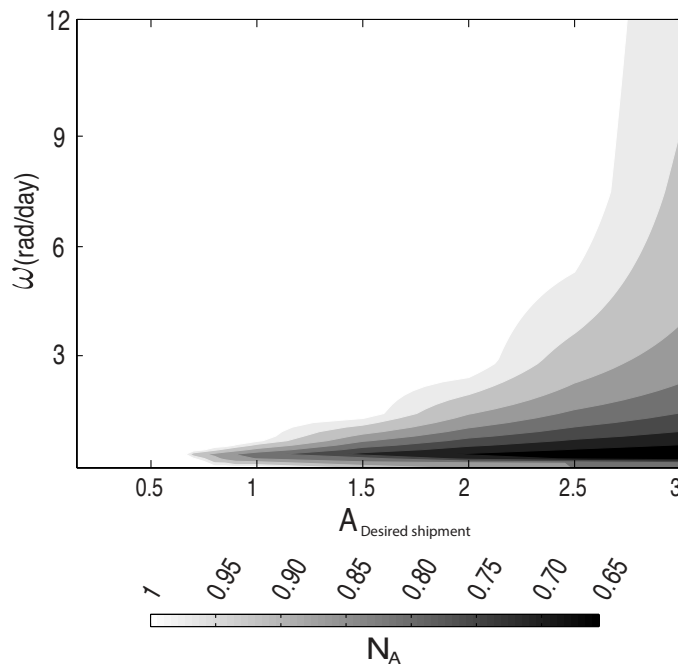

(b) Contour plot

Figure 6. Describing function gain caused by the CLIP function

4.3 Simulation results

We start our simulation process by applying a step input of 10% such that OS varies from 1000 to 1100 cases at time $t = 20$ days. Figure 7(a) illustrates the first problem previously identified by the final value theorem, the permanent negative offset. Negative offsets aggravate the resilience performance of the DC replenishment system, especially in the case of multi-event disruptions (Zobel and Khansa 2011) and increasing demand patterns. Figure 7(b) demonstrates how the system would behave if the proposed change in the *GIT* feedback information is made as stated in Section 4.1.

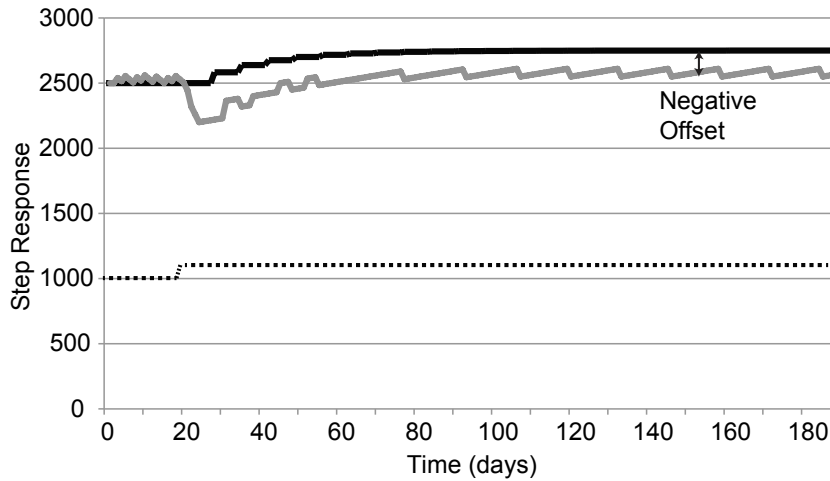

(a) 'As Is' scenario

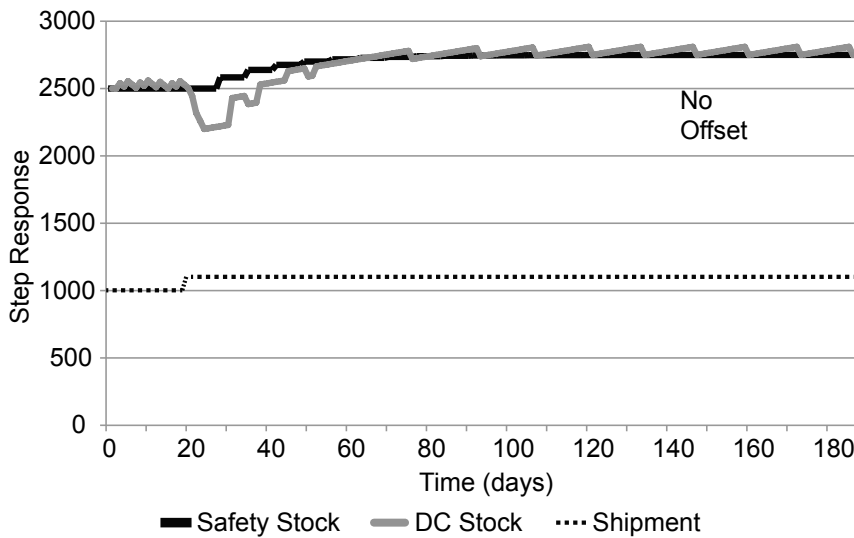

(b) Proposed change in the GIT feedback

Figure 7. Step input of 10%

In order to force a backlog situation and understand the impact of both nonlinearities, we increased the step input by 100%. By eliminating the offset, we are able to evaluate the impact of ω_n and ζ on the DC stock responses (Figure 8). Figure 8 can be used to draw an analogy to Figure 2. Figure 8(a) demonstrates that for low ω_n the system recovery is slower than for systems with high ω_n possibly leads to a quicker backlog situation. According to Figure 8(b), if the system has no damping ($\zeta = 0$), oscillations will prevail and the inventory response will never recover and are therefore not resilient. On the other hand, if the system is too overdamped (take $\zeta = 2$ as an ex-

ample) the inventory recovery will take too long, making the system vulnerable to multiple related disruption events (Zobel and Khansa 2011). When cross-referencing the results from Equations 17 and 18 and Figure 8, we found that the ROUNDING nonlinearity needs to be considered carefully as the value of $N_{A(ROQ)}$ does not have a simple relationship to resilience performance vis-à-vis the model parameter values, *Buying Quantity* and *Truckload Constraint*.

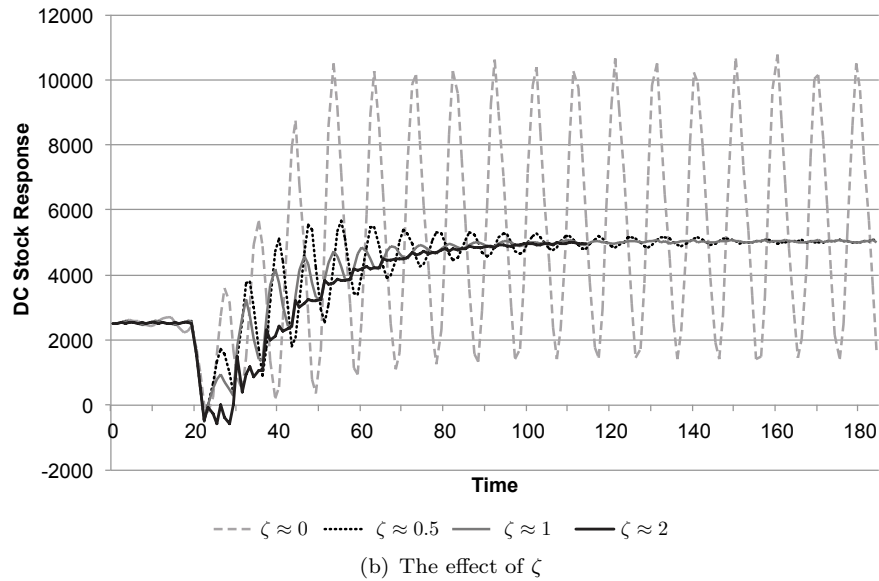
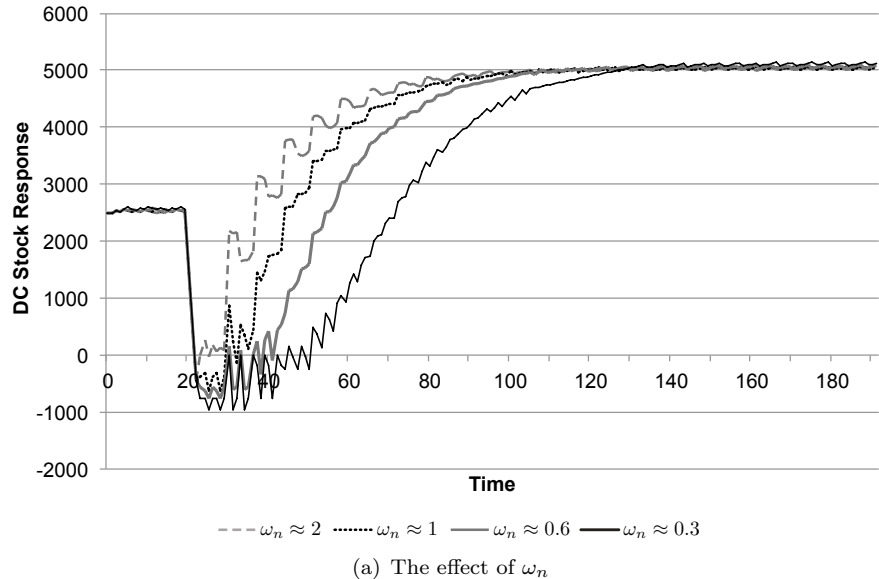
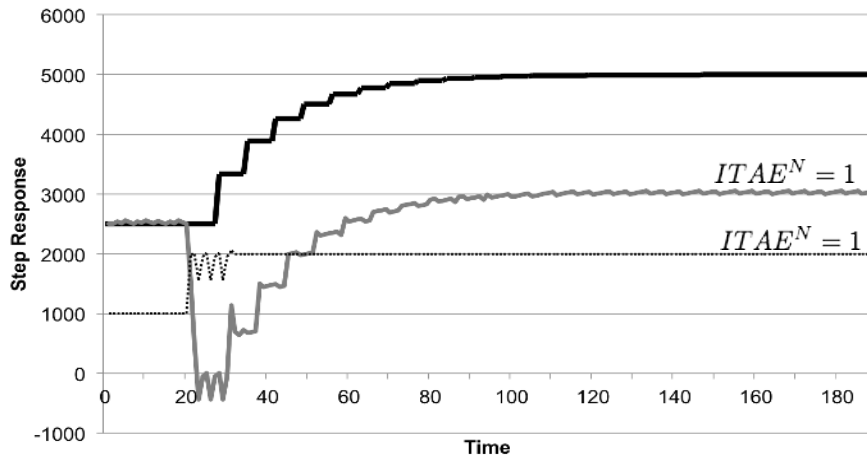
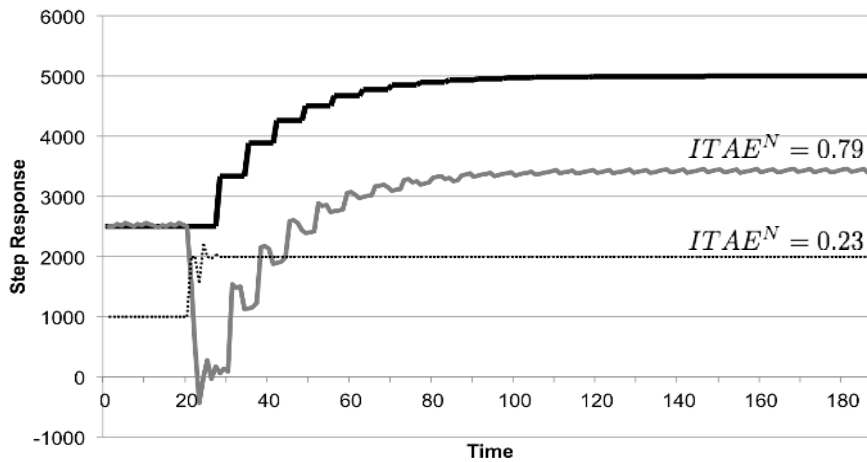

Figure 8. The effects of natural frequency and damping ratio on inventory response

Figure 9 illustrates the impact of changing T_i on the DC Stock and Shipment responses. When stock levels are negative or there is backlog shipments to the stores are no longer made in full, which may lead to on-shelf stockouts. Therefore, the replenishment system becomes less resilient to greater changes in demand and the stock offset is also intensified. By decreasing the values of the control parameter T_i , as in Figures 9(b) and 9(c), we observed an improvement in the resilience performance due to:



(a) $T_i=1$ ('As Is' scenario)



(b) $T_i=0.8$

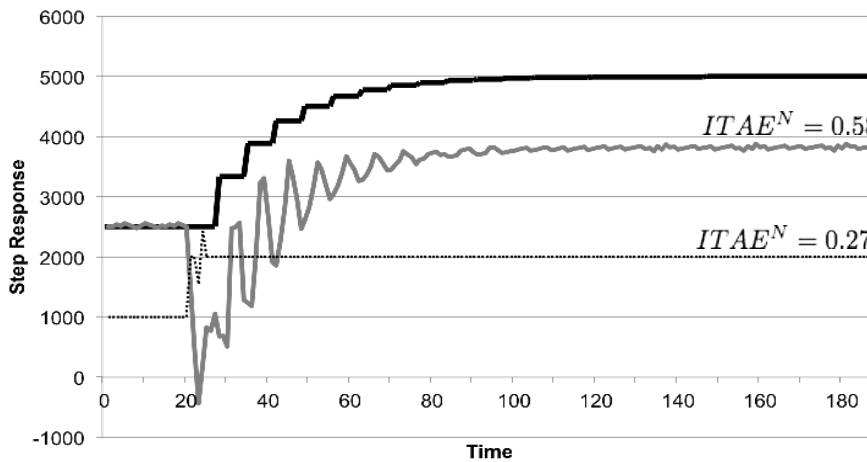

(c) $T_i=0.6$

— Safety Stock — DC Stock Shipment

Figure 9. Impact of T_i on the resilience performance of the DC

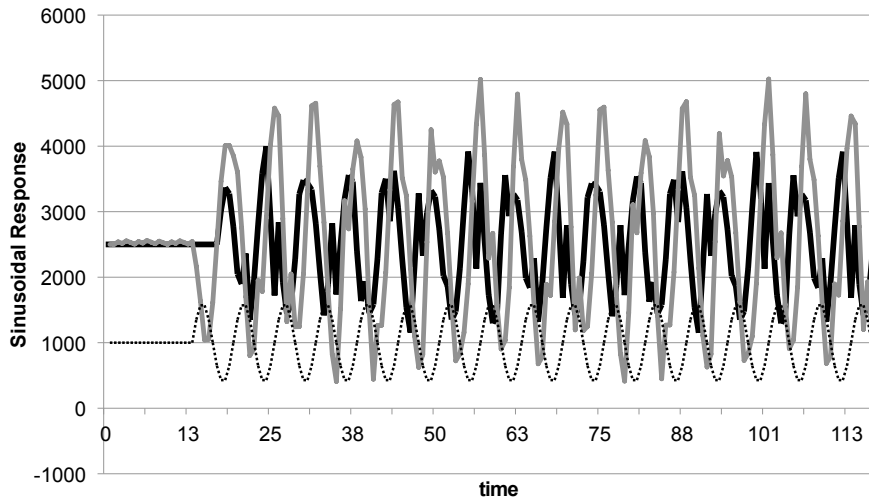

(a) $\omega=62.82$ rad/day

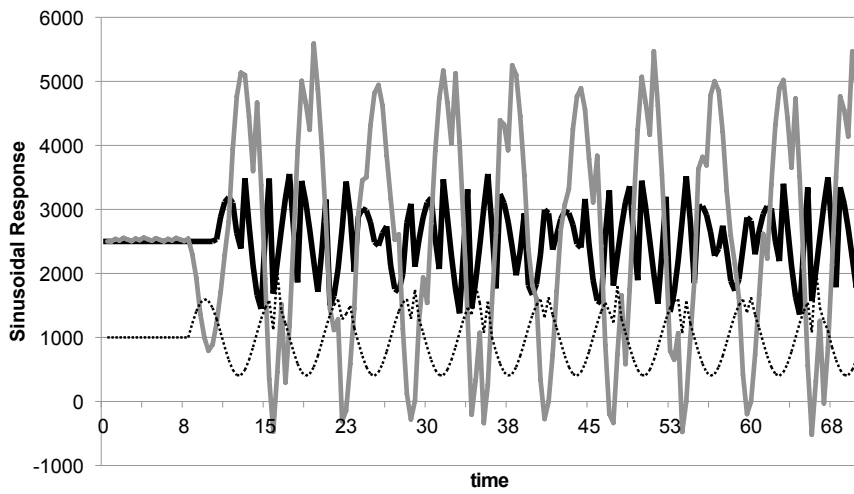

(b) $\omega=37.68$ rad/day

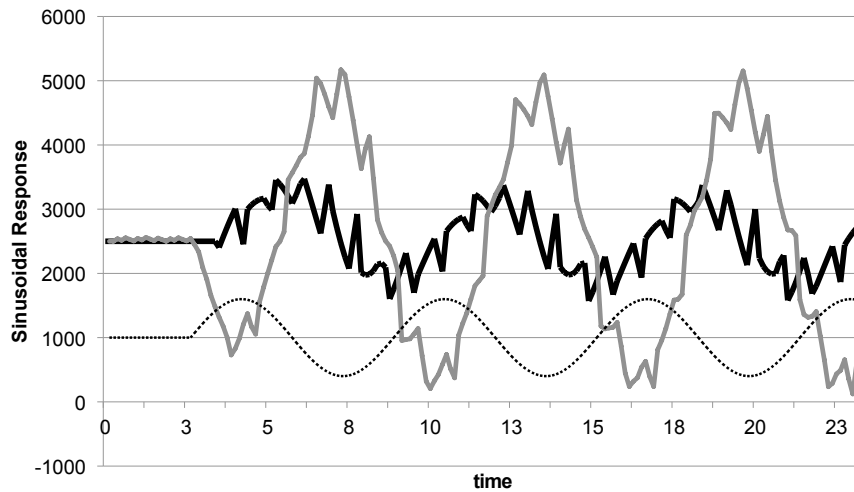

— Safety Stock — Stock Shipment

(c) $\omega=12.56$ rad/day

Figure 10. Impact of demand frequencies on the resilience performance of the DC

- i the stock offset decreases because the final value of stock oppositely depends on this parameter as demonstrated in Table 4 and
- ii inventory response and recovery times are reduced and therefore the system recovers from the backlog situation quicker.

In order to quantify the results, ITAE values of the *Stock* and *Shipment* responses have been calculated and normalised in relation to the ‘As Is’ index value. As Figure 9 shows, the ITAE decreases as T_i is adjusted to lower values. However, if T_i is too small, in this case lower than 0.5, the *Stock* response will start to oscillate considerably and potentially become unstable. Improved resilience is also obtained when decreasing the forecasting constant T_a and lead-time T_p .

Another phenomenon discovered by employing the describing function technique was that the CLIP nonlinearity in the shipment process only takes effect for low to medium frequencies and high amplitudes. The effect of high-amplitude demands has been demonstrated by increasing the step sizes in the ‘shock’ lens analysis, as previously demonstrated in Figures 7 and 9. In order to confirm the effect of demand frequencies, simulations using sinusoidal inputs of the same amplitude but different frequencies have been undertaken. Figure 10 shows that as the demand frequency decreases from 62.82 rad/day to 37.68 rad/day, a backlog situation starts to occur and therefore the system is less resilient at this frequency. But with further decreases in the input frequency, the shipment process behaves linearly and resilience is attained again, confirming the results of Figure 6. Without the analysis made in Section 4.2, this phenomenon would not have been so easily identified by conducting simulations alone.

5. Discussion and managerial implications

A number of analytical insights have been obtained from the application of NCT techniques. Table 5 summarises the insights gained from using ‘shock’ and ‘filter’ lenses, the resulting simulation experiments and the implications of not conducting a mathematical analysis before simulation.

These findings suggest that some potential improvements to the DC replenishment system can be made in order for it to become more resilient. These include the following:

- The permanent offset in the DC stock response is the most urgent issue to be resolved. It was shown here that inventory drift is a problem for the supply chain to maintain its resilience performance, especially under multi-event disruptions and uncertain demand. A proposed solution is to make the target GIT a variable related to demand and a function of the lead-time.
- Given the fact that the resilience performance has a trade-off with production, inventory and transportation costs (Christopher and Peck 2004; Sheffi and Rice 2005; Spiegler *et al.* 2012), the retailer may consider automatically adjusting the control parameters to increase resilience in times of uncertain demand patterns and abrupt, sharp changes in stock levels. Thus, the supply chain manager can prioritise change programmes that will deliver resilience or cost benefits.
- Being aware of the impact of the system’s nonlinearities and constraints is very important for the retailer. This study demonstrated that, depending on the demand amplitude and frequency, backlog situations may or may not occur. The system manager does not have to be concerned about shipment constraints (CLIP function) when demand has very high frequencies and low amplitudes. Analysis of the impact of the ROUNDING function on order quantity suggests that the system manager should group products with the same demand pattern to determine the order quantity that maximises resilience without negatively impacting warehousing and transportation costs.

A key feature of the above managerial implications is being aware of the frequency and amplitude of demand signals. Grocery customers’ normal shopping habits tend to generate high frequency demands, with peaks concentrated on Fridays and weekends when customers tend to buy most of

Table 5. Insights gained from undertaking preliminary analysis of system dynamics models

	Analytical insights	Proposed simulation experiments	Potential consequences if nonlinear analysis not undertaken
Analysis via the 'shock' lens	<ul style="list-style-type: none"> • Possibility to find system's transfer functions and ITAE estimated equations. <p>Example 1: The parameter T_i was found to be an important control parameters for resilience. It provokes opposite impacts on ITAE values. Therefore it was investigated in greater detail in the simulation process as its value may impact system stability.</p> <p>Example 2: Small values of T_a will always benefit resilience. Simulations confirmed that a demand chase strategy ($T_a = 0$ or $\alpha = 1$) is preferable and this parameter causes no problem in terms of stability.</p> <p>Example 3: Delivery lead-time T_p is also important for resilience and should be minimised.</p>	<ul style="list-style-type: none"> • Simulation process focused on important parameters for achieving supply chain resilience. 	<ul style="list-style-type: none"> • A better understanding of each control parameter's influence on resilience was achieved using both analytical and simulation techniques.
	<ul style="list-style-type: none"> • Possibility to find an inventory drift problem in the DC replenishment system. <p>Example 1: Initial and final value theorems revealed how parameters T_i and T_p influence the inventory offset. This would have been impractical with a numerical/simulation technique only.</p> <p>Example 2: Simulations confirm that T_a does not change the stock's final value.</p>	<ul style="list-style-type: none"> • Simulations were undertaken to visualise the problem and to test solutions. 	<ul style="list-style-type: none"> • Possibly gone unnoticed. Although step input simulation revealed the same result, this drift effect is only perceived if plotting both safety and current stocks together.
Analysis via the 'filter' lens	<ul style="list-style-type: none"> • Understanding the impact of the different nonlinearities (CLIP and ROUNDING functions) and input amplitudes on the system's damping ratio and natural frequency. <p>Example 1: Analysis showed that the ROUNDING function may cause a positive or negative impact on resilience depending on control parameters. Not much simulation effort was required to explore these findings. Moreover, the positive impact on resilience might never have been discovered when using only simulation.</p> <p>Example 2: The CLIP function does not cause any impact on other system responses. This effect was easily identified using describing function techniques and is confirmed via simulations.</p>	<ul style="list-style-type: none"> • Simulations were undertaken to check whether the analysis gave correct insights, and more effort has been given to check unexpected results. 	<ul style="list-style-type: none"> • The understanding of nonlinearities would be very difficult and some results would have been missed when using only simulation techniques.
	<ul style="list-style-type: none"> • Understanding the impact of different input frequencies on the system's behaviour. 	<ul style="list-style-type: none"> • Simulations were undertaken only to confirm analytical insights. 	<ul style="list-style-type: none"> • Several simulation experiments would have been necessary to gain the same insights.

the groceries needed for the week (Kamarainen *et al.* 2001; Anckar *et al.* 2002). However, 'lunch on the go' products, such as sandwiches, salad and pasta pots, have an extremely high frequency, with daily peaks during the middle of each day (Wang *et al.* 2008). In both of these cases, demand levels (in effect amplitude) may double or treble between the lowest and highest values, possibly triggering the system's nonlinearities. Therefore, the potential risk of mismatching supply and demand could be mitigated by levelling peaks and troughs.

On the other hand, for medium-low frequency demands, the nonlinearity in the shipment system will take effect more often, possibly causing backlogs and slower response and recovery. Examples of products with medium demand frequencies include cleaning products and toiletries, which are purchased on a less than weekly basis. However, considering the aggregate demand of all consumers, it is possible that the retailer does not experience such seasonality for these products.

In contrast to the above products, festive goods have almost an impulse demand, with low/no demand for most of the year and then a short peak for sales. For the UK retailer Tesco, pumpkin sales in 2012 were typically less than 15,000 units/day during most of the year but rose in the two weeks before Halloween, peaking at over 300,000 units/day on 29th October. By 1st November, sales had returned to normal levels (Autumn's Supermarket Secrets 2013).

The above discussion reflects demand signals in the food retailing industry. However, similar patterns can be observed in other retail environments including apparel and toys (Wong *et al.* 2006) and in other industries such as the steel industry (Taylor 1999; Potter and Lalwani 2008)

6. Conclusion

Preliminary mathematical analysis using NCT techniques has been undertaken in order to gain initial insights in the understanding of the DC replenishment system. This allowed the identification of specific behaviour changes in the DC stock and shipment responses, which are key indicators for assessing supply chain resilience, without going through a time-consuming simulation process. Transfer function analysis, root locus techniques and describing function techniques are a precursor for undertaking system dynamics simulations. While simulation generates confidence, analysis breeds insights.

This research is limited to the dynamics of a single-echelon supply chain system. Although the demand data and the store replenishment system have been considered in the validation process, this study has focused on analysing the resilience performance of the DC replenishment system alone. Consideration of the multi-echelon supply chain will be left for future research. Future research should also evaluate the impact of structural changes made in the DC replenishment system, such as the inclusion of new capacity constraints or introducing a collaborative strategy with suppliers. Finally, other types of nonlinearities in system dynamics models, such as the ones caused by time varying parameters, can be analysed using NCT. These nonlinearities have been so far analysed using simulation only, although several other analytical methods exist (Atherton 1975; Vukic *et al.* 2003; Karafyllis and Jiang 2011).

References

- Aastrup, J. and Kotzab, H., 2009. Forty years of out-of-stock research - and shelves are still empty. *The International Review of Retail, Distribution and Consumer Research*, 20 (1), 147–164.
- Alblas, A. and Jayaram, J., 2015. Design resilience in the fuzzy front end (FFE) context: an empirical examination. *International Journal of Production Research*, DOI:10.1080/00207543.2014.899718, 1–19.
- Ankar, B., Walden, P., and Jelassi, T., 2002. Creating customer value in online grocery shopping. *International Journal of Retail & Distribution Management*, 30 (4), 211–220.
- Atherton, D.P., 1975. *Nonlinear Control Engineering*. 1st Ed. New York: International Offices.
- Autumn's Supermarket Secrets, 2013. [television programme, online], 21:00 30 Oct, BBC ONE, 65mins. <http://bobnational.net/record/179611>. (Accessed 12/02/2015).
- Bailey, K.D., 1994. *Methods of social research*. 4th Ed. New York: The Free Press.
- Bhamra, R., Dani, S., and Burnard, K., 2011. Resilience: the concept, a literature review and future directions. *International Journal of Production Research*, 49 (18), 5375–5393.
- Blackhurst, J., Dunn, K.S., and Craighead, C.W., 2011. An Empirically Derived Framework of Global Supply Resiliency. *Journal of Business Logistics*, 32 (4), 374–391.
- Blythman, J., 2004. *Shopped*. London: Fourth Estate.
- Bruccoleri, M., Cannella, S., and Porta, G.L., 2014. Inventory record inaccuracy in supply chains: the role of workers' behavior. *International Journal of Physical Distribution & Logistics Management*, 44 (10), 796–819.
- Cannella, S. and Ciancimino, E., 2010. On the bullwhip avoidance phase: Supply chain collaboration and order smoothing. *International Journal of Production Research*, 48 (22), 6739677.
- Cannella, S., Ciancimino, E., and Márquez, A.C., 2008. Capacity constrained supply chains: a simulation study. *International Journal of Simulation and Process Modelling*, 4 (2), 139–147.
- Christopher, M. and Peck, H., 2004. Building the resilient supply chain. *International Journal of Logistics Management*, 15 (2), 1–14.
- Colicchia, C., Creazza, A., and Dallari, F., 2010. Supply chain risk management: insights from an explorative study in the Italian industry. *Logistics Research Network Annual Conference proceedings, Leeds, UK, 8-10 September*.
- Corsten, D. and Gruen, T., 2003. Desperately seeking shelf availability: an examination of the extent, the causes, and the efforts to address retail out-of-stocks. *International Journal of Retail & Distribution Management*, 31 (12), 605–17.
- de Souza, R., Zice, S., and Chaoyang, L., 2000. Supply chain dynamics and optimization. *Integrated Manufacturing Systems*, 11 (5), 348–364.

- Disney, S.M. and Towill, D.R., 2005. Eliminating drift in inventory and order based production control systems. *International Journal of Production Economics*, 93-94 (1), 331–344.
- Disney, S.M., Towill, D.R., and Warburton, R.D.H., 2006. On the equivalence of control theoretic, differential, and difference equation approaches to modeling supply chains. *International Journal of Production Economics*, 101 (1), 194–208.
- Fernie, J., 1992. Distribution strategies of European retailers. *European Journal of Marketing*, 26 (8/9), 35–47.
- Fernie, J. and Sparks, L., 2004. *Logistics and Retail Management: Insights into Current Practice and Trends from Leading Experts*. London: Kogan Page.
- Forrester, J.W., 1958. Industrial dynamics: a major breakthrough for decision makers. *Harvard Business Review*, 36 (4), 37–66.
- Forrester, J.W., 1968. Industrial Dynamics - after the first decade. *Management Science*, 14 (7), 398–415.
- Gaalman, G. and Disney, S.M., 2009. On bullwhip in a family of order-up-to policies with ARMA(2,2) demand and arbitrary lead-times. *International Journal of Production Economics*, 121 (2), 454–463.
- Groceries Code Adjudicator, 2014. Groceries Code Adjudicator Annual Report: 23 June 2013 31 March 2014, https://www.gov.uk/government/uploads/system/uploads/attachment_data/file/322415/10143-GCA-Annual_Report_2014.pdf. (Accessed 16/02/2015).
- Hamdouch, Y., 2011. Multi-period supply chain network equilibrium with capacity constraints and purchasing strategies. *Transportation Research Part C: Emerging Technologies*, 19 (5), 803 – 820.
- Hingley, M., Lindgreen, A., Grant, D., and Kane, C., 2011. Using fourth-party logistics management to improve horizontal collaboration among grocery retailers. *Supply Chain Management: An International Journal*, 16 (5), 316–327.
- Ivanov, D., Hartl, R., Dolgui, A., Pavlov, A., and Sokolov, B., 2014a. Integration of aggregate distribution and dynamic transportation planning in a supply chain with capacity disruptions and the ripple effect consideration. *International Journal of Production Research*, DOI:10.1080/00207543.2014.986303.
- Ivanov, D. and Sokolov, B., 2013. Control and system-theoretic identification of the supply chain dynamics domain for planning, analysis, and adaptation of performance under uncertainty. *European Journal of Operational Research*, 224 (2), 313–323.
- Ivanov, D., Sokolov, B., and Dolgui, A., 2014b. The Ripple effect in supply chains: Trade-off 'efficiency-flexibility-resilience' in disruption management. *International Journal of Production Research*, 52 (7), 2154–2172.
- Jeong, S., Oh, Y., and Kim, S., 2000. Robust control of multi-echelon production-distribution systems with limited decision policy. *KSME International Journal*, 14 (4), 380–392.
- John, S., Naim, M.M., and Towill, D., 1994. Dynamic analysis of a WIP compensated decision support system. *International Journal of Manufacturing System Design*, 1 (4), 283–297.
- Juntunen, J. and Juga, J., 2009. Controlling the bullwhip with transport capacity constraints. *International Journal of Services and Standards*, 5 (2), 160–171.
- Kamarainen, V., Saranen, J., and Holmstrom, J., 2001. The reception box impact on home delivery efficiency in the e-grocery business. *International Journal of Physical Distribution & Logistics Management*, 31 (6), 414–426.
- Karafyllis, I. and Jiang, Z., 2011. *Stability and Stabilization of Nonlinear Systems*. London: Springer-Verlag.
- Larsen, E.R., Morecroft, J.D.W., and Thomsen, J.S., 1999. Complex behaviour in a production-distribution model. *European Journal of Operational Research*, 119, 61–74.
- Laugesen, J. and Mosekilde, E., 2006. Border-collision bifurcation in a dynamic management game. *Computers & Operations Research*, 33, 464–478.
- Mason-Jones, R. and Towill, D., 1998. Shrinking the supply chain uncertainty circle. *Control*, 24 (7), 17–23.
- Mohapatra, P.K.J., 1980. Nonlinearity in system dynamics models. *Dynamica*, 6 (1), 36–52.
- Mula, J., Campuzano-Bolari, F., Diaz-Madronero, M., and Carpio, K.M., 2013. A system dynamics model for the supply chain procurement transport problem: comparing spreadsheets, fuzzy programming and simulation approaches. *International Journal of Production R*, 51 (13), 4087–4104.
- Naim, M.M. and Towill, D.R., 1994. Establishing a Framework for Effective Materials Logistics Management. *International journal of Logistics Management*, 5 (1), 81–88.
- Nise, N.S., 2000. *Control systems engineering*. 3rd Ed. New York: John Wiley & Sons.
- Paik, S.K. and Bagchi, P.K., 2007. Understanding the causes of the bullwhip effect in a supply chain. *International Journal of Retail & Distribution Management*, 35 (4), 308–324.
- Pereira, C.R., Christopher, M., and Silva, A.L.D., 2014. Achieving supply chain resilience: the role of procurement. *Supply Chain Management: An International Journal*, 19 (5/6), 626–642.

- Pettit, T.J., Fiksel, J., and Croxton, K.L., 2010. Ensuring supply chain resilience: development of a conceptual framework. *Journal of Business Logistics*, 31 (1), 1–21.
- Ponomarov, S.Y. and Holcomb, M.C., 2009. Understanding the concept of supply chain resilience. *International Journal of Logistics Management*, 20 (1), 124–143.
- Potter, A. and Lalwani, C., 2008. Investigating the impact of demand amplification on freight transport. *Transportation Research Part E*, 44 (5), 835–846.
- Potter, A., Mason, R., and Lalwani, C., 2007. Analysis of factory gate pricing in the UK grocery supply chain. *International Journal of Retail & Distribution Management*, 35 (10), 821–834.
- Saleh, M., Oliva, R., Kampmann, C.E., and Davidsen, P.I., 2010. A comprehensive analytical approach for policy analysis of system dynamics models. *European Journal of Operational Research*, 203 (3), 673–683.
- Sargent, R.G., 2013. Verification and validation of simulation models. *Journal of Simulation*, 7 (1), 12–24.
- Sheffi, Y. and Rice, J.B., 2005. A supply chain view of the resilient enterprise. *MIT Sloan Management Review*, 47 (1), 41–48.
- Shukla, V., Naim, M.M., and Yaseen, E.A., 2009. ‘Bullwhip’ and ‘backlash’ in supply pipelines. *International Journal of Production Research*, 47 (23), 6477–6497.
- Spiegler, V.L.M. and Naim, M.M., 2014. The impact of freight transport capacity limitations on supply chain dynamics. *International Journal of Logistics Research and Applications*, 17 (1), 64–88.
- Spiegler, V.L.M., Naim, M.M., and Wikner, J., 2012. A control engineering approach to the assessment of supply chain resilience. *International Journal of Production Research*, 50 (21), 6162–6187.
- Sterman, J.D., 1984. Appropriate summary statistics for evaluating the historical fit of system dynamics models. *Dynamica*, 10, 51–66.
- Sterman, J.D., 1989. Modelling managerial behaviour: misperceptions of feedback in a dynamic decision making experiment. *Management Science*, 35 (3), 321–339.
- Syntetos, A., Georgantzias, N., Boylan, J., and Dangerfield, B., 2011. Judgement and supply chain dynamics. *Journal of the Operational Research Society*, 62 (6), 1138–1158.
- Taylor, D., 1999. Measurement and analysis of demand amplification across the supply chain. *International Journal of Logistics Management*, 10 (2), 55–70.
- Tierney, K. and Bruneau, M., 2007. Conceptualizing and measuring resilience: a key to disaster loss reduction. *TR news*, May-June (250), 14–17.
- Towill, D.R., 1982. Dynamic analysis of an inventory and order based production control system. *International Journal of Production Research*, 20 (6), 671–687.
- Towill, D.R., Zhou, L., and Disney, S.M., 2007. Reducing the bullwhip effect: looking through the appropriate lens. *International Journal of Production Economics*, 108 (1/2), 444–453.
- Vukic, Z., Kuljaca, L., Donlagic, D., and Tesaknjak, S., 2003. *Nonlinear Control Systems*. New York: Marcel Dekker.
- Wang, X., Disney, S., and Wang, J., 2014. Exploring the oscillatory dynamics of a forbidden returns inventory system. *International Journal of Production Economics*, 147, Part A, 3–12.
- Wang, X. and Disney, S.M., 2012. Stability Analysis Of Constrained Inventory Systems. *European Journal of Operational Research*, 223 (1), 86–95.
- Wang, Y., Potter, A., Mason, R., and Naim, M., 2008. Aligning transport performance measures with customised retail logistics: a structured method and its application. *International Journal of Logistics: Research and Applications*, 11 (6), 457–473.
- Warburton, R. and Disney, S., 2007. Order and inventory variance amplification: The equivalence of discrete and continuous time analyses. *International Journal of Production Economics*, 110 (1-2), 128–137.
- Wilson, M., 2007. The impact of transportation disruptions on supply chain performance. *Transportation Research Part E: Logistics and Transportation Review*, 43 (4), 295–320.
- Wong, C., Arlbjorn, J., Hvolby, H.H., and Johansen, J., 2006. Assessing responsiveness of a volatile and seasonal supply chain: A case study. *International Journal of Production Economics*, 104, 709–721.
- Zhou, L., Disney, S., and Towill, D., 2010. A pragmatic approach to the design of bullwhip controllers. *International Journal of Production Economics*, 128 (2), 556–568.
- Zobel, C.W. and Khansa, L., 2011. Characterizing multi-event disaster resilience. *Computers & Operations Research*, 42, 83–94.

Appendix A. Qualitative phase: conceptualising the model

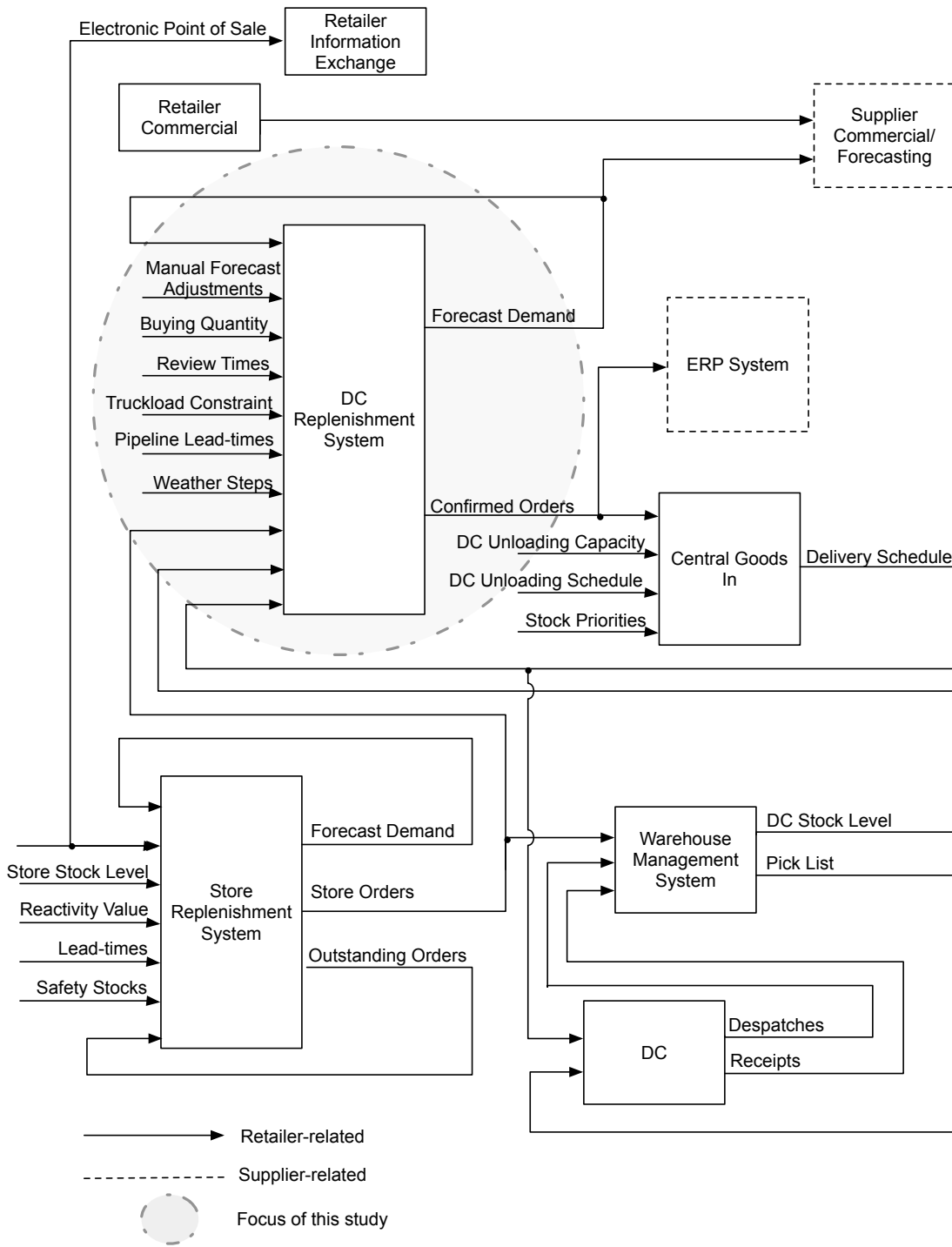

Figure A1. Input-output diagram of the grocery retailer replenishment control system

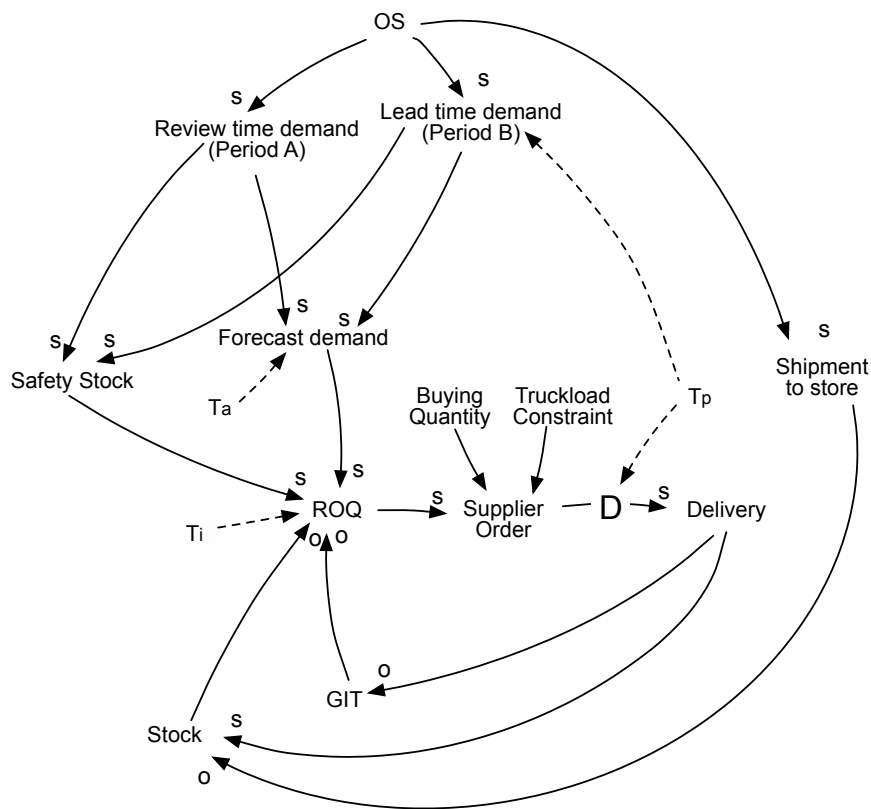

Figure A2. Causal loop diagram of the DC replenishment control system

Appendix B. Non-linear difference equations of the DC replenishment system

Table B1. Difference equations

Description	Difference equation
Time period	w, in weeks
Time period	d, in days
Orders from Store	$\begin{cases} OS(d), OS \text{ are received daily} \\ OS(w) = \sum_{i=1}^7 OS(d-i), \text{ for forecasting purpose OS are aggregated weekly} \end{cases}$
Forecast Weekly Demand	$FWD(w) = FWD(w-1) + \frac{1}{1+T_a}(OS(w) - FWD(w-1))$
Period A Demand	$Period\ A\ Demand(d) = D_A \cdot FWD(w)$
Period B Demand	$Period\ B\ Demand(d) = D_B \cdot FWD(w)$
Forecast Demand	$Forecast\ Demand(d) = Period\ A\ Demand(d) + Period\ B\ Demand(d)$
Delivery from suppliers	$Delivery(d) = Supplier\ Order(d - T_p)$
Maximum shipping	$Max.ship.(d) = Stock(d-1) + Delivery(d)$
Desired shipping	$D.ship.(d) = Backlog(d-1) + OS(d)$
Shipment	$Shipment(d) = MIN[D.ship.(d), Max.ship.(d)]$
Safety Stock	$SS(d) = \left(\frac{1}{2} Period\ A\ Demand(d) + Period\ B\ Demand(d)\right)K$
DC On Hand Stock Level	$Stock(d) = Stock(d-1) + Delivery(d) - Shipment(d)$
Backlog Level	$Backlog(d) = Backlog(d-1) + OS(d) - Shipment(d)$
Goods in Transit	$GIT(d) = \sum_{i=1}^{T_p} Supplier\ Order(d - T_p - i)$
Raw Order Quantity	$ROQ(d) = Forecast\ Demand(d-1) + \frac{(SS(d-1) - Stock(d-1))}{T_i} + (Target\ GIT - GIT(d-1))$
Supplier Order	$Supplier\ Order(d) = MAX[0, ROUND[ROQ(d), (Buying\ Quantity, Truckload\ Constraint)]]$