

Title	Theoretical Prediction and Control of Welding Distortion in Large Structures Considering Positioning and the Gap between Parts(Mechanics, Strength & Structure Design, INTERNATIONAL SYMPOSIUM OF JWRI 30TH ANNIVERSARY)
Author(s)	Deng, Dean
Citation	Transactions of JWRI. 32(1) P.219-P.222
Issue Date	2003-07
Text Version	publisher
URL	<a href="http://hdl.handle.net/11094/6918">http://hdl.handle.net/11094/6918</a>
DOI	
rights	本文データはCiNiiから複製したものである
Note	

*Osaka University Knowledge Archive : OUKA*

<https://ir.library.osaka-u.ac.jp/>

Osaka University

# Theoretical Prediction and Control of Welding Distortion in Large Structures Considering Positioning and the Gap between Parts†

Dean DENG\*

## Abstract

*Ships and automobiles are fabricated from thin curved plates. To assemble these parts, welding is commonly used. However, it is impossible to avoid distortion induced by welding. The distortion causes problems not only in the assembling process but also in the final products. The shrinkage of the weld zone is just one of the reasons for the distortion during assembly. Other factors, such as positioning, fixtures and welding sequence must be controlled to achieve the required precision. In this research, a finite element method (FEM) for predicting the welding distortion of three-dimensional curved structures for considering positioning and the gap between parts is proposed. In this method, an interface element is introduced to model the joining process. The usefulness of the proposed method is demonstrated through the prediction of the welding distortion of curved plate structures and the influence of the gap correction is investigated.*

**KEY WORDS:** (Welding distortion) (Inherent strain) (Interface element) (Gap) (Positioning)

## 1. Introduction

Thin plate structures, such as ships and passenger trains, are produced by assembling curved three-dimensional parts by welding. However, the welding deformation caused by local shrinkage is unavoidable. The welding deformation produced in the structure creates gaps between already assembled parts of the structure and the parts to be welded. When gaps or misalignment exceed the tolerable limit, the welding itself becomes impossible or the geometrical accuracy cannot be maintained. Thus, the gaps must be controlled within permissible limit by appropriate correction procedures. In this report, a method to predict the distortion of a structure during assembly by welding is proposed and the influences of the gap and its correction on the geometrical accuracy are examined.

To deal with the local deformation and the gap, an elastic Finite Element code in which the local deformation is considered through the inherent strain, and the gap is modeled using an interface element<sup>1)</sup>. In the proposed method, the gap and the various joining state between parts, such as the free states, the state in the positioning process and the fully joined state after completion of welding can be represented by selecting appropriate values for the parameters ( $\gamma$ : bonding strength,  $r_0$ : scale parameter,  $\delta_G$ : size of gap) involved in the interface element<sup>2)</sup>. By using the interface element, the welding deformation during assembly process can be precisely predicted.

## 2. Method of Analysis

### 2.1 Interface Element

The assembly of the structure can be regarded as

the repetition of the positioning of new parts and the welding. The parts are physically free before positioning. Through positioning, the relative position of the part, the gap and the misalignment are corrected within tolerable limits. By welding, full bonding between the parts is achieved. To model the real assembly process, the change of physical state must be modeled. In particular, the positioning process must be modeled carefully by considering contact, slide and gap between parts. For this purpose, the interface element is introduced. The change of physical state between parts can be described through the bonding stress-relative displacement relation. **Figure 1** shows the interface element defined between two parts ( or two elements belonging to the parts to be joined ). The relative displacements between the two parts are normal opening  $\delta_N$ , transverse opening  $\delta_T$ , longitudinal sliding  $\delta_L$  and relative rotation  $\delta_{\theta X}$ . Similarly, the stresses acting between the parts are denoted as  $\sigma_N$ ,  $\sigma_T$ ,  $\sigma_L$  and  $\sigma_{\theta X}$ , respectively.

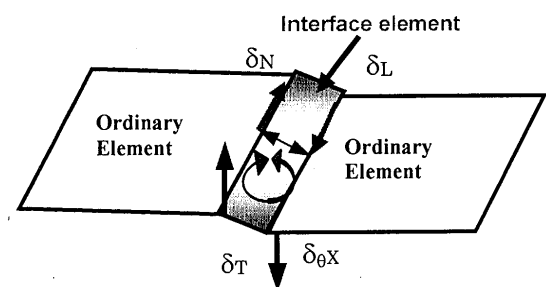

Fig. 1 Types of gap described in the interface element.

† Received on January 30,2003

\* Foreign Research Fellow,  
(Chongqing University)

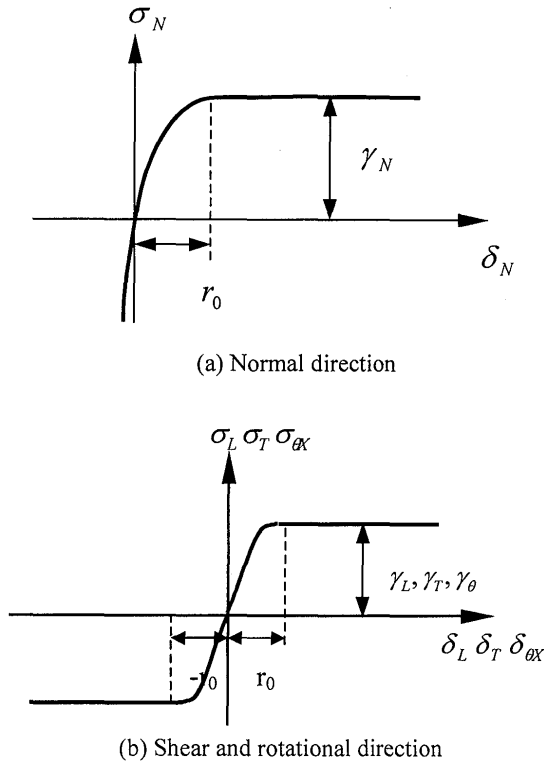

Fig. 2 Relationship between bonding stress and displacement.

The relationships between the stress  $\sigma$  and the displacement  $\delta$  are schematically shown in **Figures 2(a)** and **(b)**. Due to the symmetry of the shear deformation and rotational deformation, the relation between displacement and stress is symmetric as shown in Fig. 2(b). While that in normal direction is not symmetric as shown in Fig. 2(a).

**2.2 Procedure of Analysis**

The finite element method proposed in this report is developed to predict the distortion of curved thin plate structures by considering the details of the assembly process, such as the positioning, gap correction, tack welding and joining. The parts are subdivided into a finite element mesh using 4-point rectangular plate elements. The state of joining is described by the interface element that is introduced between parts to be joined. The local distortion due to the welding thermal cycle is taken into account through the inherent strain introduced to the elements facing the welding line. Thus, the detailed assembly process can be simulated by controlling the parameters involved in the interface element and the inherent strain according to the assembly stage.

**3. Curved Structure Model and Welding Condition**

The welding deformation of the curved three dimensional structure shown in **Figure 3** consisting of three longitudinal

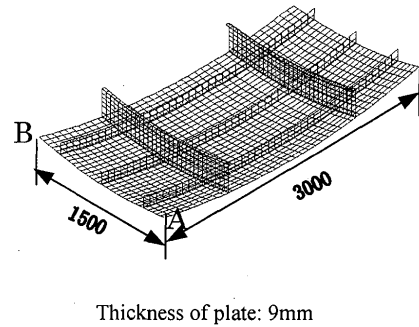

Fig. 3 Asymmetry curved structural model.

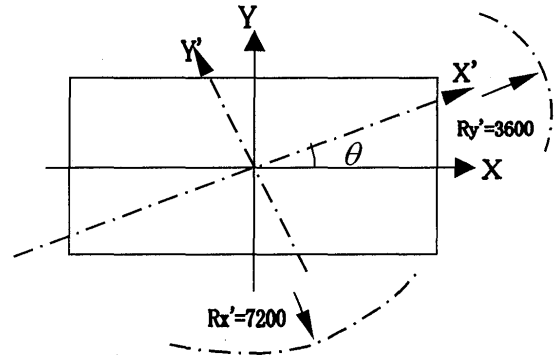

Fig. 4 Principal direction of skin plate.

and two transverse stiffeners and a skin plate is analyzed using the proposed method. Both the stiffeners and the skin plate are curved members. The geometrical shape of the skin plate is given by Eq. (1). It is a curved asymmetrical plate. The curvatures of the skin plate in the principal directions are  $1/7200 \text{ mm}^{-1}$  in  $X'$  and  $1/3600 \text{ mm}^{-1}$  in  $Y'$  directions as shown in **Figure 4**. In this model, the orientation of the principal direction from that of the longitudinal stiffeners  $\theta$  is 20 degree and the maximum deflection of the skin plate is 305 mm.

$$Z = R_x + R_y - \sqrt{R_x^2 - X^2} - \sqrt{R_y^2 - Y^2} \tag{1}$$

$$X' = X \cos \theta + Y \sin \theta \quad Y' = -X \sin \theta + Y \cos \theta$$

where,

$X, Y$ : coordinates along stiffeners

$X', Y'$ : coordinates in principal direction

$R_{x'}$ : radius of curvature in  $X'$  direction

$R_{y'}$ : radius of curvature in  $Y'$  direction

The heat inputs for each welding line are assumed as follows:

Transverse stiffener/Skin plate: 535 J/mm;

Longitudinal stiffener/Skin plate: 441 J/mm;

Transverse stiffener/Longitudinal stiffener: 441 J/mm.

4. Simulated Cases

In this research, the influence of the gap correction on the distortion is investigated. To clarify the influence of the gap, three cases, namely Cases A, B and C, are analyzed. In Case A, all members are assumed to have no geometrical error. Thus, there is no gap as shown in **Figure 5**. In Case B, the longitudinal stiffener is assumed to have larger curvature compared to the designed shape and the gap increases toward its ends as shown in **Figure 6**. In contrast, the longitudinal stiffener is assumed to have smaller curvature and the maximum gap appears at its center as shown in **Figure 7**. The maximum values of the gap are approximately 5 mm in both Cases B and C. These gaps are corrected by pulling the longitudinal stiffeners and the skin plate together using the interface element. The parameter  $\gamma$ , which gives the maximum force per unit area to correct the gap, is assumed to be 1.0 MPa in Cases B and C. After the gap correction, the members are assumed to be tack welded and the final welding is done simultaneously.

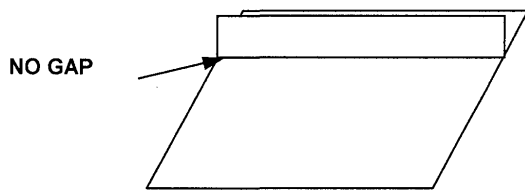

Fig. 5 No initial gap between L-stiffener and skin plate.

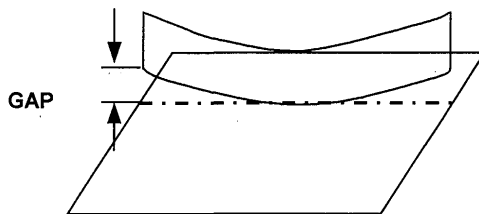

Fig. 6 Edge type initial gap between L-stiffener and skin plate.

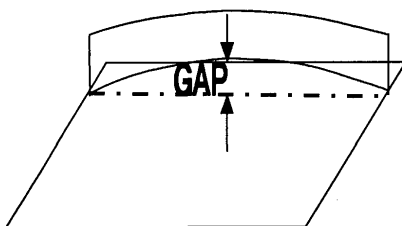

Fig. 7 Middle type initial gap between L-stiffener and skin plate.

5. Computed Results and Discussion

The distortion in Case A is shown in **Figure 8**. As seen from this figure, the twisting distortion can be produced by welding alone when the structure is asymmetric. **Figures 9 and 10** show the distortion after gap correction and the final distortion after welding in Case B, respectively. As seen from the comparison between Figs. 8 and 10, the gap correction can produce fairly large twisting distortion compared to the welding deformation itself. In **Figure 11**, the three cases are compared with respect to the distortion after welding along the line 1 as shown in Fig. 10. When there is no gap (Case A), the maximum deflection is 15.0mm. The deflection is produced by welding alone. In Case B, in which the end type gap exists and the welding is performed after gap correction, the distortion increases to 23.0 mm. This means that to reduce the distortion of the structure during assembly, not only the welding deformation, but also the gap must be carefully controlled. When the gap is the center type, the distortion is reduced to 3.0 mm. This tells us that the direction of the twisting distortion changes with the type of the gap.

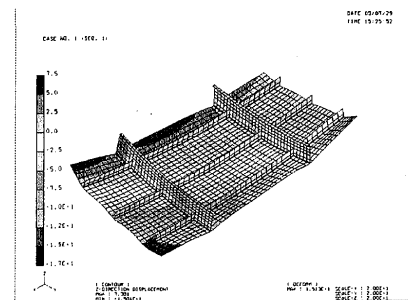

Fig. 8 Welding deformation of case A

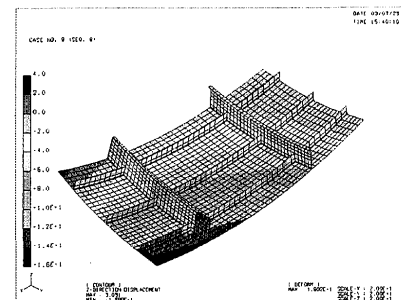

Fig. 9 Deformation after positioning of case B.

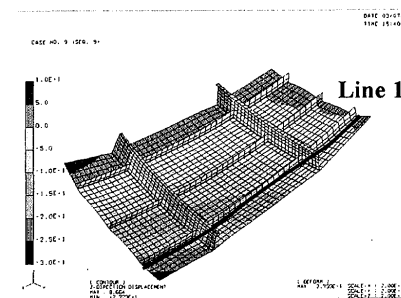

Fig. 10 Final deformation of case B.

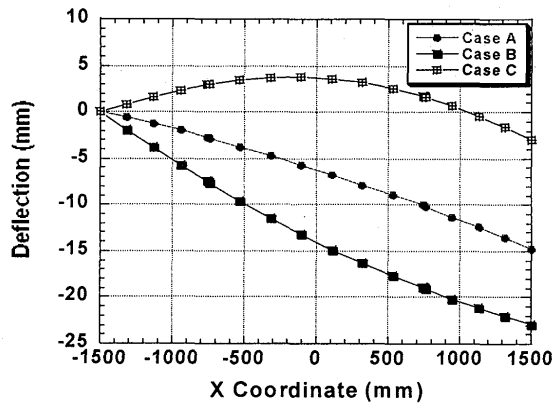

Fig. 11 Deflection of line 1 in cases A, B, C.

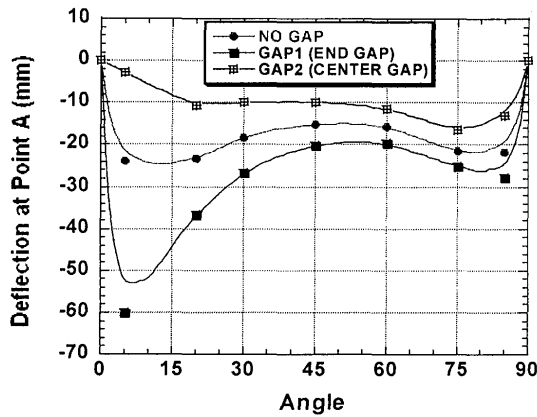

Fig. 12 Relationship between angles of principle and twisting distortion.

In general, the mode of distortion produced during the assembly process becomes symmetric when the structure and welding sequence are symmetric and buckling does not occur. To clarify the relation between the degree of asymmetry and the magnitude of twisting distortion, the orientation of the principal direction of the curvature shown in Fig. 4 is changed from 0 degree to 90 degree and the distortion is analyzed. **Figure 12** summarizes the relation between the orientation of the principal

axis and the twisting. The twisting is represented by the difference of deflection between points A and B in Fig.3. Three lines in Fig. 12 show the twisting of the structure without gap, with end type and center type gaps. Twisting does not occur when the orientation is 0 degree or 90 degree. In these cases, the structure becomes geometrically symmetric. Excluding these two cases, significantly large twisting distortion is observed and the magnitude of distortion varies with the orientation angle. The magnitude of twisting becomes maximum value when the orientation angle is approximately 10 degree. Such tendency is commonly observed both in cases with and without the gap.

6. Conclusions

- (1) By introducing the interface element, it becomes possible to treat the positioning, the gap correction and the joining processes in a unified fashion.
- (2) When the structure is asymmetric, distortion in twisting mode can be produced by welding local deformation alone.
- (3) When the gap exists between the longitudinal stiffeners and the skin plate, the gap correction process produces twisting of structures in addition to that caused by welding. The direction of the twist changes with the type of the gap.
- (4) The orientation of the principal axis of the skin plate has a great influence on the twisting of the structure during assembly.

References

- 1) Hidekazu Murakawa and Zhengqi Wu: Computer Simulation Method for Crack Growth Using Surface Energy and its Application to Interface Stripping of Composite Material, J.Kansai Soc.N.A, No. 230 (1998), pp.247-255.
- 2) Hidekazu Murakawa, Dean Deng and Masakazu Shibahara : Prediction of Welding Distortion during the Assembly Process of Thin Plate Structures (1st Report)-Prediction of Welding Distortion Considering Gap and Misalignment-, J.Kansai Soc.N.A, No. 238 (2002).