

University of Nebraska - Lincoln

DigitalCommons@University of Nebraska - Lincoln

David Sellmyer Publications

Research Papers in Physics and Astronomy

December 1986

Thermal and structural stability of cosputtered amorphous Ta_xCu_{1-x} alloy thin films on GaAs

J.E. Oh

University of Nebraska - Lincoln

John A. Woollam

University of Nebraska-Lincoln, jwoollam1@unl.edu

K.D. Aylesworth

University of Nebraska - Lincoln

David J. Sellmyer

University of Nebraska-Lincoln, dsellmyer@unl.edu

J.J. Pouch

NASA Lewis Research Center, Cleveland, Ohio

Follow this and additional works at: <https://digitalcommons.unl.edu/physics Sellmyer>

 Part of the [Physics Commons](#)

Oh, J.E.; Woollam, John A.; Aylesworth, K.D.; Sellmyer, David J.; and Pouch, J.J., "Thermal and structural stability of cosputtered amorphous Ta_xCu_{1-x} alloy thin films on GaAs" (1986). *David Sellmyer Publications*. 143.

<https://digitalcommons.unl.edu/physics Sellmyer/143>

This Article is brought to you for free and open access by the Research Papers in Physics and Astronomy at DigitalCommons@University of Nebraska - Lincoln. It has been accepted for inclusion in David Sellmyer Publications by an authorized administrator of DigitalCommons@University of Nebraska - Lincoln.

Thermal and structural stability of cosputtered amorphous Ta_xCu_{1-x} alloy thin films on GaAs

J. E. Oh and J. A. Woollam

Department of Electrical Engineering, University of Nebraska, Lincoln, Nebraska 68588-0511

K. D. Aylesworth and D. J. Sellmyer

Behlen Laboratory of Physics, University of Nebraska, Lincoln, Nebraska 68588

J. J. Pouch

NASA Lewis Research Center, Cleveland, Ohio 44135

(Received 23 May 1986; accepted for publication 13 August 1986)

The thermal and chemical stabilities of amorphous-metal diffusion barrier films are of importance in high-temperature semiconductor device applications. The reaction characteristics of the barrier constituents with the surrounding elements as well as the crystallization temperature determine the thermal stability of an amorphous-alloy diffusion barrier. We report that suitable thin films of Ta-Cu have been prepared over a wide range of compositions, by cosputter deposition onto GaAs and fused-quartz substrates. The amorphous nature and crystallization behavior of the films have been monitored by x-ray diffraction and van der Pauw resistivity measurements. Films were found to be amorphous over the range of 55–95 at. % Ta. In addition, Auger electron spectroscopy surveys and depth profiles were used to investigate the various interdiffusion reactions between the amorphous diffusion barrier, polycrystalline Au overlayers, and GaAs substrates. Barriers of $Ta_{93}Cu_7$ are remarkably effective in preventing Au in-diffusion, a 3000-Å layer remaining unpenetrated after an annealing at 700 °C for 20 min. Diffusion of Ga and/or As into amorphous 93 at. % Ta is more rapid than that of Au. Interfacial reactions formed Ta_3Au , $CuAu$, $TaAs_2$, Ga_3Cu_7 , Cu_3As , and other unidentified compounds formed above 700 °C.

I. INTRODUCTION

A number of problems prevent the use of conventional electronics at sustained elevated temperatures, and the interdiffusion of metal and semiconductor is one of the dominant causes of device failure. A thermally robust metal-semiconductor contact which retained electrical stability after exposure to temperature of 500 °C for tens of hours could find useful application in equipment exposed to hostile environments. Also a layer which maintains metallurgical integrity during a 20-min anneal at 800 °C could find application in self-aligned gate technology.¹

Unfortunately the objectives mentioned above cannot be achieved using conventional polycrystalline diffusion-barrier layers because of fast grain-boundary diffusion. Grain boundaries can be eliminated by forming either single-crystalline or amorphous layers. The former approach has not been possible as yet. The latter solution has recently been investigated by a number of groups.^{1–5} The results that are now emerging are promising, and suggest that films of amorphous metallic alloys may offer new and viable alternatives in the important area of semiconductor metallization. A number of workers have investigated several amorphous metallic alloys to demonstrate their superior stability to conventional barriers on exposure to elevated temperatures.

An important parameter that characterizes an amorphous alloy is the recrystallization temperature T_c assuming that the amorphous nature is responsible for their successful performance as a barrier. Other important properties required of amorphous barrier alloys arise when contemplat-

ing the use of the material in a semiconductor device. There are a large number of such requirements, and in general they are similar to those found for polycrystalline barriers. These include such factors as electrical resistivity, adhesion, and thermal-expansion coefficient, but the most important is the compatibility with the semiconductor and the processing procedures employed.

We have taken into account such requirements for amorphous diffusion barriers and prepared Au/amorphous alloy/GaAs systems, based on Ta-Cu. Amorphous tantalum-copper films can be easily obtained over a significant composition range by cosputtering⁶ and electron-beam evaporation⁷ from a composite target. They are known to be structurally quite stable; the recrystallization temperature of tantalum-rich (up to 80%) amorphous Ta-Cu films was shown⁷ to exceed 800 °C. In the present work we have selected this alloy system because of its high crystallization temperature, and have extended the Ta composition range up to 95%, nearly the maximum with respect to maintaining the thermally stable amorphous microstructure. In this paper we report the thermal and structural stability of sputter-deposited, extremely Ta-rich Ta-Cu alloys, and discuss the potential use of these alloys as diffusion barriers in Au-GaAs contacts.

II. EXPERIMENT

The substrates used in this study were Ge-doped (*n*-type) single-crystal GaAs wafers having a (100)-crystal orientation, as well as fused quartz. The substrates were pol-

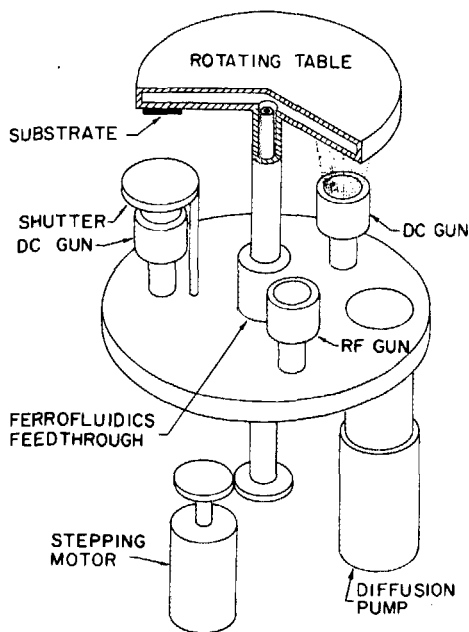

FIG. 1. Schematic of multigun sputtering system.

ished and cleaned using standard procedures. The clean substrates were placed in a cold-trapped diffusion-pumped chamber, in which there was an independently operating magnetron rf gun and two dc guns, as well as a water-cooled computer-controlled rotating table with substrate holder on the bottom side (see Fig. 1). Sputtering was by means of rf and dc argon ions impinging on targets of high-purity (99.999%) Ta and Cu, respectively. A typical base pressure of the chamber was 1×10^{-7} Torr, and the Ar pressure was 5 mTorr. The composition could be easily controlled by operating two guns separately with optimized and known deposition rates. These rates and compositions were confirmed by the Auger electron spectroscopy (AES) results which revealed semiquantitatively the atomic concentration of constituents by taking into account the sensitivity of Auger signals to each element. This yielded less than a 2% error in the value of the composition over the entire composition range. The table was rotated with a constant speed of 60 rpm to produce completely intermixed metal-alloy films. Typical deposition thicknesses of both constituents per rotation were less than 1 Å within which even one monolayer could not be formed. A typical thickness of an alloy film was 3000 Å, and the subsequently deposited Au was evaporated on some samples to observe the behavior of a Au overlayer on these alloy films. Ta-Cu films had strong adhesion to both GaAs and fused-quartz substrates even after annealing to 800 °C. The electrical resistivities of all alloys were measured by the van der Pauw technique, and their microstructures were determined by x-ray diffraction (XRD).

As the crystallization of amorphous metals is controlled by kinetic factors, the measured crystallization temperature depends on the time scale of the experiment. The characteristic time for crystallization, however, is an extremely strong function of temperature, so that the reasonable estimation of the maximum crystallization temperature of an amorphous metallization can be obtained using temperature-varying an-

nealing with reasonably long annealing time. Therefore, to determine the crystallization temperature of the metallizations we set the annealing time to 20 min, which is the typical annealing time for post-implantation annealing in device and circuit manufacturing. The results reported here were obtained by annealing the samples in an evacuated stainless-steel tube with diffusion pumping and liquid-nitrogen trapping. In order to determine the crystallization temperature of a given alloy composition, the following sequence was performed. The first anneal was done at 200 °C for 20 min, after which the sample was removed from the furnace for examination by x-ray diffraction and resistivity. After these examinations, the sample was reloaded into the furnace and annealed at 300 °C for 20 min. This procedure was repeated at 100 °C increments up to 800 °C.

To observe the effect of a Au overlayer on the crystallization of this alloy system, thin Au films (thickness of 400 Å) were deposited on Ta₈₀Cu₂₀ and Ta₉₃Cu₇ films, and the total transverse resistivities of the double-layer films (in electrical parallel) were measured using the van der Pauw technique as a function of annealing temperature. The Au layer thickness was kept low in order to enhance sensitivity. Indeed, the total resistivity was found to be quite sensitive to compound formation between Au and constituents of the Ta-Cu alloys. It was especially sensitive to thinning of the Au overlayer due to the diffusion of Au into the Ta-Cu film. These changes in resistivity indicated the onset of partial crystallization at the interface of the Au and Ta-Cu alloys, assuming that in-diffusion occurred mainly along grain boundaries. The success of these measurements was dependent upon the large differences in resistivities between polycrystalline Au and amorphous Ta-Cu alloys.

In addition to the experiments described above, we have studied the interdiffusion in the Au/Ta-Cu/GaAs system using Auger electron spectroscopy (AES) combined with XRD measurements. The Ta-Cu/GaAs system without a Au overlayer was also investigated in order to study the effect of a Au overlayer on this system. AES spectra were obtained simultaneously with Ar-ion milling. The variations of the peak-to-peak height of the primary signals of the ele-

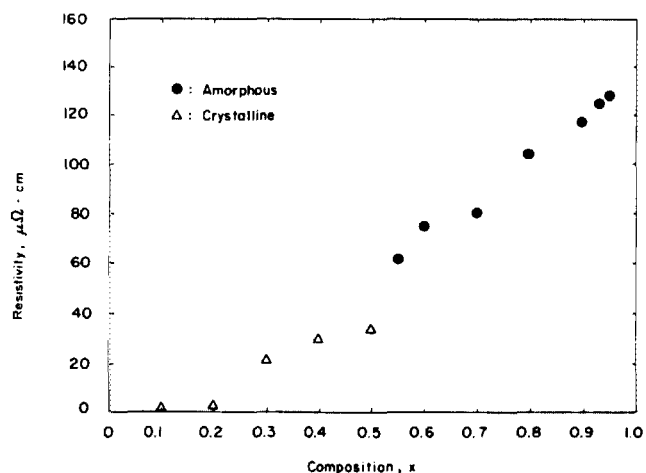

FIG. 2. Measured resistivity of Ta_xCu_{1-x} alloys with various compositions (at room temperature).

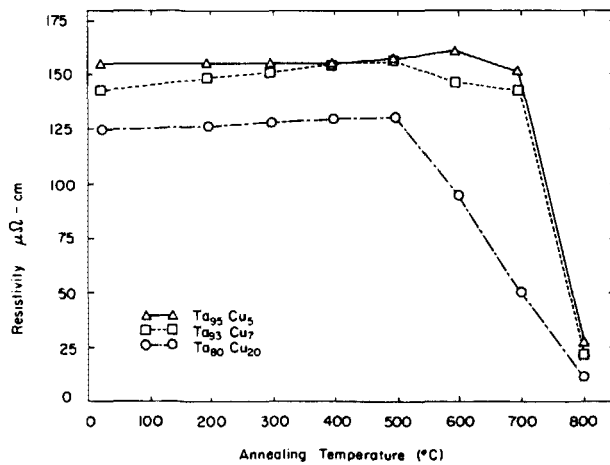

FIG. 3. Resistivity curves obtained from cosputtered Ta-Cu alloy films with various compositions: A— $x = 0.95$, B— $x = 0.93$, C— $x = 0.8$. All films were deposited on fused-quartz substrates, and then vacuum annealed for 20 min.

ments analyzed were recorded as functions of the sputtering time for the AES analysis.

III. RESULTS AND DISCUSSION

A. Annealing effects on resistivity

The resistivity of the films as a function of composition is shown in Fig. 2. Note from Fig. 2 that the glass-forming composition range was extensive. Alloys containing 55–95 at. % Ta were amorphous, and resistivities increased with increasing composition up to 95%. Alloys having more than 95 at. % Ta were not investigated in this study. In view of the wide range of amorphous composition found in the Ta-Cu system, three Ta-rich compositions, 80, 93, and 95 at. % of Ta, were selected for a detailed study as to how optimum diffusion-barrier action would be obtained. It is shown in Fig. 3 that the resistivity increases slightly in the early stages of annealing. This annealing behavior continues over a wide range of temperatures, being strongly dependent on the composition. The resistivity of $Ta_{80}Cu_{20}$ decreased monotonically upon further annealing, and showed complete crystallization at 800 °C. After annealing at 800 °C, the diffraction peaks corresponded to all the allowed reflections of parent metals, namely the fcc Cu and bcc Ta, crystalline phase. The resistivity change in the $Ta_{93}Cu_7$ shows the same pattern with that of $Ta_{80}Cu_{20}$, except that the decrease is slower at first (600–700 °C), and faster in the region from 700 to 800 °C. A similar behavior was observed in the resistivity change of $Ta_{95}Cu_5$, but there was a higher starting temperature (700 °C) for the partial recrystallization.

Figures 4 and 5 show a sequence of typical XRD scans of $Ta_{93}Cu_7$ and $Ta_{80}Cu_{20}$ films. It is somewhat difficult to judge whether or not small features on the amorphous peaks correspond to the early stages of crystallization. It seems to be likely that the path of crystallization in the Ta-Cu system is complex. Sharpening and narrowing of diffraction peaks would indicate grain growth. Estimate of grain sizes as a function of annealing, however, could not be done since the differences were not distinct until complete recrystallization

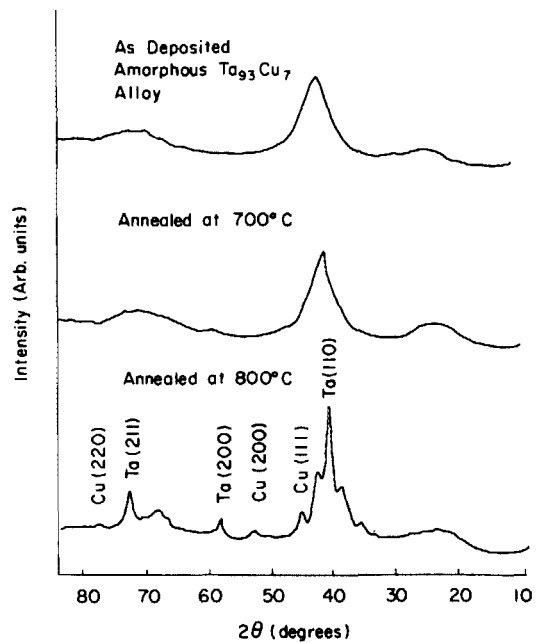

FIG. 4. X-ray diffraction spectra of a - $Ta_{93}Cu_7$ heated to various temperatures and subsequently cooled to room temperature.

had occurred. This implies that weak Ta and Cu crystalline phase reflections superimposed on the amorphous background at temperatures lower than 800 °C, and that the degree of recrystallization of the film in this intermediate temperature range is slower when it contains higher atomic percent Ta. These measurements indicated that the more Ta-rich cosputtered films are more thermally stable. Thus high Ta composition Ta-Cu alloys are suitable diffusion-barrier materials.

The recrystallization temperatures we report here are lower than those reported by others. This difference could be

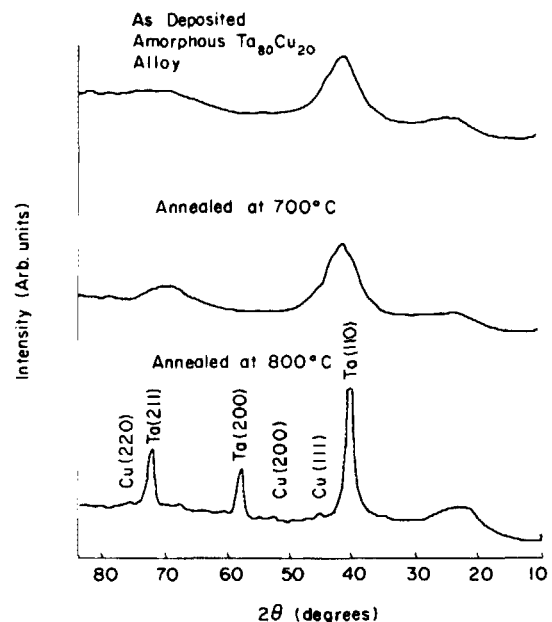

FIG. 5. X-ray diffraction spectra of a - $Ta_{80}Cu_{20}$ heated to various temperatures and subsequently cooled to room temperature.

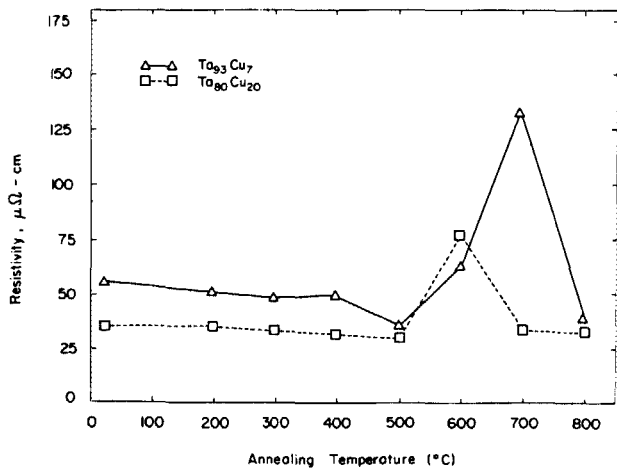

FIG. 6. Total resistivity of layered films, Au(400 Å)/Ta-Cu (3000 Å) heated to various temperatures; (a) Ta₉₃Cu₇, (b) Ta₈₀Cu₂₀.

due to an impurity contribution to the crystallization kinetics owing to the two different deposition techniques used (*e*-beam evaporation versus cosputtering). It could also be due to changes in recrystallization kinetics when Ta-Cu is deposited on various substrates. It could also be due to differences in how various research groups define the crystallization temperature for these alloys.

Total resistivity measurements on the layered film, Au (400 Å)/Ta-Cu alloys (Ta₈₀Cu₂₀ and Ta₉₃Cu₇), were performed with the various annealing temperatures and results are shown in Fig. 6. No distinguishable change was observed up to an annealing temperature of 500 °C, but resistivities in both samples started to increase after annealing to 600 °C, which can be attributed to diffusion of Au into the diffusion-barrier material. It should be noted that this is the temperature region in which partial crystallization was observed, as shown in Fig. 3.

In the case of the Ta₉₃Cu₇ alloy the increase in resistivity with temperature continued up to 700 °C, and it was slightly lower than the resistivity of the host film itself, which implies that Au atoms completely diffused along grain boundaries and formed compounds with Ta and/or Cu. The XRD measurements identified Ta, Au, Ta₃Au, and CuAu in the sample annealed to 700 °C. However these reactions occurred only near the interface between the Au and the Ta-Cu alloy film since the Auger depth profile with Ar-ion sputtering showed only limited penetration of Au into the 3000-Å-thick Ta₉₃Cu₇ film (within the ~50 Å distinction limit of AES). The XRD spectrum showed only a series of polycrystalline Au diffraction peaks plus the amorphous background in samples annealed to 600 °C. The resistivity decreased as did the resistivity of a host film after the completion of in-diffusion and compound formation. The results for the Au/Ta₈₀Cu₂₀ system showed a similar behavior at lower temperatures.

The diffusion of Au into the Ta-Cu alloy system happened in the same annealing temperature range found for the microstructural changes of the Ta-Cu metallic alloy at the different annealing temperatures. More pronounced features were superimposed along with the amorphous back-

TABLE I. Results of annealing experiments for a series of alloys. T_0 is the highest annealing temperature at which no evidence of crystallinity is observed. T_1 is the lowest annealing temperature at which some evidence of crystallinity was observed by XRD. T_2 is the temperature at which there is complete crystallization.

Sample	T_0 (°C)	T_1 (°C)	T_2 (°C)
Ta ₉₃ Cu ₇	700	800	800
Ta ₉₃ Cu ₇	600	700	800
Ta ₈₀ Cu ₂₀	500	600	800
Au/Ta ₉₃ Cu ₇	500	600	800
Au/Ta ₈₀ Cu ₂₀	400	500	700

ground in the samples with a Au overlayer, implying that Ta-Cu crystallization may be accelerated and thus occur at reduced temperatures by the presence of a polycrystalline Au overlayer.

There are several possible mechanisms to account for the decreased crystallization temperature with Au overlayer. For example, the material in the top Au layer can diffuse partially into the amorphous metal to form an alloy with a reduced T_c which would then crystallize, allowing a more rapid diffusion of the overlayer species into the underlying amorphous layer. The process would then proceed until the entire film had crystallized. Another possible mechanism would be that the polycrystalline Au overlayer provides sites for the initiation of crystallization of the amorphous metal that are not available at the single-crystal GaAs substrate surface. Perhaps the polycrystalline Au layer would act as an effective catalyst in promoting the crystallization of Au compound phases from the amorphous alloy.

The results of the annealing studies to date are given in Table I. The temperature T_0 is the highest annealing temperature at which no evidence of crystallinity has been observed. T_1 is the lowest annealing temperature of which some evidence of crystallinity has been observed by XRD. T_2 is the temperature at which each series of Ta and/or Cu alloy is crystallized completely.

B. Structural stability of Ta-Cu alloys

The results of AES analysis of the as-deposited and representative annealed samples for the structure: Au(1500 Å)/Ta₉₃Cu₇ or Ta₈₀Cu₂₀(3000 Å)/GaAs, as a function of distance from the top surface of the Au film and inward, are shown in Figs. 7 and 8, respectively. For simplicity, carbon and oxygen profiles are not included. The abscissa in the figures represent the sputtering time in minutes. The sputtering time may be used as an approximate measure of the depth of the sample profile because the sputtering conditions, namely the Ar pressure and the primary ion current, were held constant throughout profiling. The Au/Ta-Cu alloy interfaces in the unannealed samples [Figs. 7(a) and 8(a)] appear to be relatively sharp whereas those of the Ta-Cu alloys/GaAs are slightly diffused. This is mainly due to problems associated with AES-ion sputtering which usually cause nonuniform crater shapes, matrix effects, molecular-ion formation, memory effects, charging effects, and

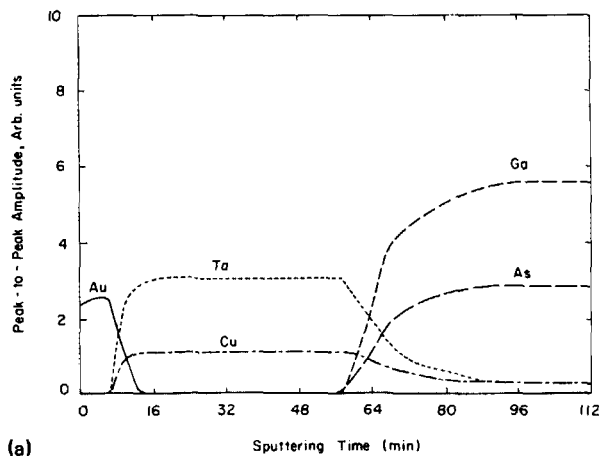

(a)

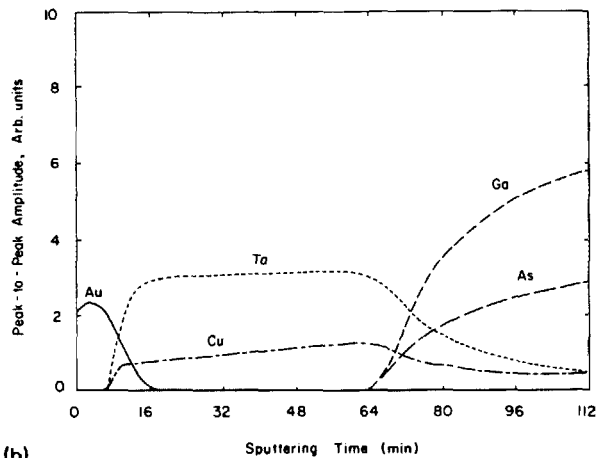

(b)

FIG. 7. (a) Schematic AES depth profiles showing the effect of no anneals on Cu 7 at. % Ta barrier on GaAs substrate with Au overlayer. (b) Schematic AES depth profiles showing the effect of anneal at 700 °C on Cu 7 at. % Ta barrier on GaAs substrate with Au overlayer.

atomic mixing effects.⁸ The small valley of Cu in the depth profiles of Ta₈₀Cu₂₀ alloy film as seen in Fig. 8 is probably due to a fluctuation of the Cu deposition rate which occurred for some unknown reasons.

For the system of Au/Ta₉₃Cu₇/GaAs, the as-deposited structure is maintained up to and including the 500 °C anneal. That is, neither Ta nor Cu has reacted with the GaAs substrate, nor is Au diffusing into the diffusion barrier. Figure 7(b) shows that there was a slight broadening of the Au/Ta-Cu and Ta-Cu/GaAs interfaces. There was also Cu accumulation at the interface of Ta-Cu/GaAs, which can be seen in the curve for the Au/Ta₈₀Cu₂₀/GaAs, sample heat treated to 500 °C as shown in Fig. 8(b).

Phase separation has been reported in the alloy-film system [Ni-Ta (see Ref. 9) W-Pt (see Ref. 10)] on a GaAs substrate. This phenomenon has been explained in terms of differences in the temperatures and mechanisms on the compound formation for the two groups of metals. The effect of a phase separation on the electrical properties at the interface between the Ta-Cu alloy and a GaAs substrate is presently being pursued. It is suspected that the temperature at which Cu begins to accumulate at the interface [Fig. 8(b)] may relate to the amorphous nature of these alloy films, since these temperatures also correspond with the temperatures at

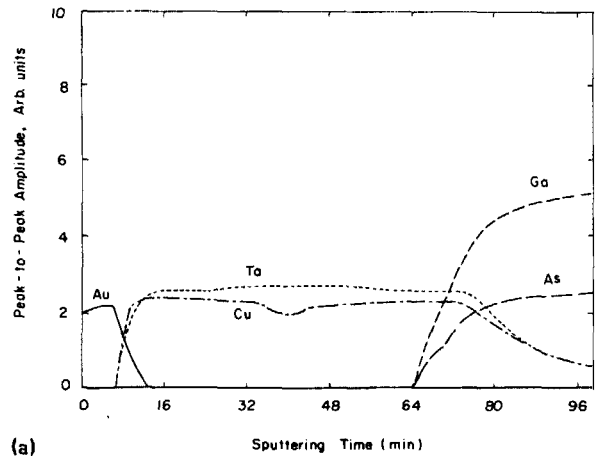

(a)

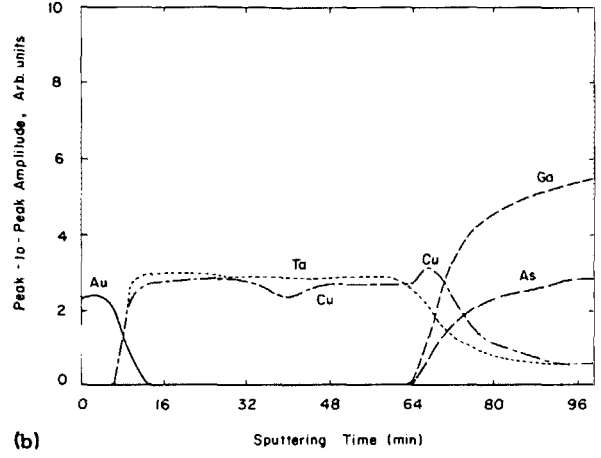

(b)

FIG. 8. (a) Schematic AES depth profiles showing the effect of no anneal on Cu 20 at. % Ta barriers on GaAs substrates with Au overlayers. (b) Schematic AES depth profiles showing the effect of anneal to 500 °C on Cu 20 at. % Ta barriers on GaAs substrates with Au overlayer.

which each alloy film is partially crystallized. The x-ray examinations showed that heating to 500 and 600 °C had not caused the amorphous-barrier layer to crystallize, but some crystalline phase was detected in the sample heated to 700 °C, in which no appreciable Ga accumulation on the metal film and no measurable interdiffusion was observed. It is interesting to note that we found that interdiffusion between Au and amorphous Ta₉₃Cu₇ occurred only near its interface with GaAs even after being annealed to 700 °C. This is true despite the fact that amorphous Ta₉₃Cu₇ film contained a small but detectable volume fraction of the microcrystalline phase, as determined by the resistivity and XRD measurements. Thus we believe that partially crystalline films can still function as effective diffusion barriers as long as the crystallites are well separated by an amorphous matrix. Ga and As outdiffusion was observed in the sample with the Ta₉₃Cu₇ alloy film heat treated to 800 °C.

The results of XRD studies on the Au/Ta₉₃Cu₇/GaAs sample are summarized in Table II. Samples heat treated at temperatures up to and including 600 °C exhibit diffraction patterns for Au and amorphous Ta₉₃Cu₇ only, whereas samples that were heat treated to temperatures higher than 700 °C exhibit diffraction patterns for other phases in addition to these. The results of x-ray analysis strongly suggest

TABLE II. Phases found (or not found) by XRD at a series of four temperatures.

	Major phase	Minor phase	Trace
500 °C	Amorphous Ta-Cu
600 °C	Amorphous Ta-Cu
700 °C	Amorphous TaCu	Ga ₃ Cu ₇ (220) Ga ₃ Cu ₇ (331) Ga ₃ Cu ₇ (420)	TaAs ₂ (211) TaAs ₂ (400)
800 °C	Three-constituent compounds	Cu ₃ As(111) Cu ₃ As(220) Cu ₃ As(222) Cu ₃ As(311) Cu ₃ As(331)	

the presence of binary compounds and unidentified three-constituent compounds results from the 800 °C heat treatment.

IV. SUMMARY

The thermal and structural properties of cosputter-deposited Ta-Ca alloy thin films on GaAs substrates were investigated as a function of annealing up to 800 °C for 20 min. The as-deposited Ta-Cu films over an extended range of 55–95 at. % Ta were amorphous and started to recrystallize into independent bcc Ta and fcc Cu at annealing temperatures of 800 °C. The extremely Ta-rich films remained amorphous even after annealing up to 700 °C, and showed strong adhesion to GaAs and fused-quartz substrates. An accelerated recrystallization of these films due to the presence of a Au overlayer was observed at 100 °C below their crystallization temperatures occurring without Au. This is probably due to compound formation, as well as the presence of nucleation sites supplied by the polycrystalline Au overlayer. The Ta₉₃Cu₇ film prevented Au and GaAs elements from interdiffusing with each other even after a heat treatment to

700 °C. The diffusion barrier failed after an 800 °C annealing, at which temperature both Ga and As out-diffusion was observed. The Ta₉₃Cu₇ alloy film was more stable than either pure Ta or pure Cu as a diffusion barrier, suggesting that Ta and Cu are strongly bonded together in the amorphous matrix.

ACKNOWLEDGMENTS

The authors would like to thank Professor N. J. Ianno for helpful discussions, and Z. S. Shan and Z. R. Zhao for help with sample preparation. We are indebted for equipment grants to the Layman Fund of the University of Nebraska and Dale Electronics, Norfolk, Nebraska. This research was supported by NASA Lewis grant no. NAG-3-154 and National Science Foundation grant no. INT 8419546.

¹J. D. Wiley, J. H. Perepezko, J. E. Nordman, and K. -J. Guo, *IEEE Trans. Ind. Eng. IE-29*, 154 (1982).

²M. Finetti, E. Pan, I. Suni, and M. -A. Nicolet, *Appl. Phys. Lett.* **42**, 987 (1983).

³A. Christou, W. T. Anderson, M. L. Bark, and J. E. Davey, *Proceedings of the 20th Annual Reliability Symposium* (IEEE, New York, 1982), p. 188.

⁴A. G. Todd, P. G. Harris, I. H. Scobey, and M. J. Kelly, *Solid State Electron.* **27**, 507 (1984).

⁵E. A. Dobisz, D. B. Aaron, K. J. Guo, J. H. Perepezko, R. E. Thomas, and J. D. Wiley, *J. Non-Cryst. Solids* **61**, 901 (1984).

⁶J. E. Oh, J. A. Woollam, K. Aylesworth, D. J. Sellmyer, and J. J. Pouch, *Bull. Am. Phys. Soc.* **31**, 489 (1986).

⁷M. Nastasi, F. W. Saris, L. S. Hung, and J. W. Mayer, *J. Appl. Phys.* **58**, 3052 (1985).

⁸J. W. Coburn, *J. Vac. Sci. Technol.* **13**, 1037 (1976).

⁹A. Lahav and M. Eizenberg, *Appl. Phys. Lett.* **45**, 256 (1984).

¹⁰T. Okumura and K. N. Tu, *Appl. Phys. Lett.* **47**, 42 (1985).