

Northumbria Research Link

Citation: Gouda, M. M., Danaher, Sean and Underwood, Chris (2001) Thermal comfort based fuzzy logic control. Building Services Engineering Research and Technology, 22 (4). pp. 237-253. ISSN 0143-6244

Published by: SAGE

URL: <http://dx.doi.org/10.1177/014362440102200403>
<<http://dx.doi.org/10.1177/014362440102200403>>

This version was downloaded from Northumbria Research Link:
<http://nrl.northumbria.ac.uk/id/eprint/1405/>

Northumbria University has developed Northumbria Research Link (NRL) to enable users to access the University's research output. Copyright © and moral rights for items on NRL are retained by the individual author(s) and/or other copyright owners. Single copies of full items can be reproduced, displayed or performed, and given to third parties in any format or medium for personal research or study, educational, or not-for-profit purposes without prior permission or charge, provided the authors, title and full bibliographic details are given, as well as a hyperlink and/or URL to the original metadata page. The content must not be changed in any way. Full items must not be sold commercially in any format or medium without formal permission of the copyright holder. The full policy is available online: <http://nrl.northumbria.ac.uk/policies.html>

This document may differ from the final, published version of the research and has been made available online in accordance with publisher policies. To read and/or cite from the published version of the research, please visit the publisher's website (a subscription may be required.)

Thermal comfort based fuzzy logic controller

MM Gouda BSc MSc^a, S Danaher BSc PhD CPhys CEng MIEE^a and CP Underwood BSc PhD CEng MCIBSE MASHRAE^b

^aSchool of Engineering, University of Northumbria, Newcastle upon Tyne, UK

^bSchool of the Built Environment and Sustainable Cities Research Institute, University of Northumbria, Newcastle upon Tyne, UK

Most heating, ventilation and air conditioning (HVAC) control systems are considered as temperature control problems. In this work, the predicted mean vote (PMV) is used to control the indoor temperature of a space by setting it at a point where the PMV index becomes zero and the predicted percentage of persons dissatisfied (PPD) achieves a maximum threshold of 5%. This is achieved through the use of a fuzzy logic controller that takes into account a range of human comfort criteria in the formulation of the control action that should be applied to the heating system to bring the space to comfort conditions. The resulting controller is free of the set up and tuning problems that hinder conventional HVAC controllers. Simulation results show that the proposed control strategy makes it possible to maximize the indoor thermal comfort and, correspondingly, a reduction in energy use of 20% was obtained for a typical 7-day winter period when compared with conventional control.

List of symbols

T_o	outdoor air temperature (°C)	Met	human metabolic rate (W/m ²)
T_i	internal air temperature (°C)	pv	relative air velocity (m/s)
T_j	surface temperature of the j th construction element (°C)	f_{cl}	ratio of body's surface area when fully clothed to body's surface area when nude
T_{mrt}	mean radiant temperature (°C)	I_{cl}	thermal resistance of the clothing (Clo)
T_{cl}	surface temperature of clothing (°C)	h_c	convection heat transfer coefficient (W/m ² K)
A_j	surface area of the j th construction element (m ²)	M	mass of air in a room (kg)
ϕ_i	internal relative humidity (%)	m_o	input ventilation mass flow rate (kg/s)
ϕ_{ext}	outdoor air relative humidity (%)	Q_l	latent heat gain (kJ)
S	percentage saturation	h	Specific enthalpy of water vapour (kJ/kg)
g	moisture content of air (kg/kg)	C	Specific heat capacity of air (kJ/kgK)
g_{ss}	moisture content of air at saturation (kg/kg)		
H_r	internal air enthalpy (kJ/kg)		
H_o	outdoor air enthalpy (kJ/kg)		
Pw_{sat}	partial pressure of saturated water-vapour at a given temperature (N/m ²)		
a, b	constants		

1 Introduction and review

Over the years, a large number of thermal comfort indices have been established for the analysis of indoor climates and the design of heating, ventilation and air conditioning (HVAC) systems.¹⁻⁴ Several have been used to assess the extent to which an existing room climate achieves satisfactory comfort conditions for occupants. A thermal comfort index, called effective temperature (ET),

Address for correspondence: CP Underwood, School of the Built Environment, University of Northumbria, Newcastle upon Tyne NE1 8ST, UK. E-mail: chris.underwood@unn.ac.uk

has been proposed as a combination of indoor temperature (T_i) and indoor relative humidity (ϕ_i). This concept was further developed and adopted as a thermal comfort index by ASHRAE⁵ and has been widely adopted as a design and comfort performance criterion for decades.

Fanger¹ published a general comfort equation which makes it possible, for specified activity and clothing levels, to calculate all combinations of the environmental variables (air temperature, air humidity, mean radiant temperature, and relative air velocity) which will create optimal thermal comfort. In order to derive the comfort equation, Fanger supposed that for long exposures to a constant thermal environment with a constant metabolic rate, a heat balance can be established for the human body such that bodily heat production is equal to heat dissipation. Based on these assumptions, Fanger developed a thermal sensation index to predict the mean thermal sensation vote on a standard scale for a large group of persons depending on the four thermal environmental variables, together with a defined activity level and 'clo-value' based on clothing worn by the occupants. He defined this as a 'predicted mean vote' (PMV) and, concomitantly, a 'percentage of persons dissatisfied' (PPD) was also defined. ISO Standard 7730⁶ has adopted Fanger's proposals based on a PMV of 0 with a tolerance of ± 0.5 .

The role of HVAC services is to provide these standards of comfort at minimum energy use and it is the HVAC control system that has the crucial influence over this. Previous work has shown that it is possible to reach these objectives if HVAC control strategies are based on a thermal sensation index instead of air temperature alone^{1,7,8} and the advantages of such a strategy have been reported in terms of improved thermal comfort performance and energy saving.^{9,10}

Presently, the proportional-integral-derivative controller continues to satisfy most non-domestic HVAC applications. One of the reasons for their popularity is that they require little *a priori* information about the plant and do not necessarily require detailed modelling information about the

plant. However, they do require information on plant dynamics during commissioning since the proportional, integral and derivative gain constants of this controller require to be determined either by manual tuning or by online tuning in some way. Since these constants depend on system parameters in most cases, re-tuning is necessary when the parameters themselves change (e.g., due to changes in plant operating point, operating mode, malfunction or modifications to the plant itself).

One alternative to this, which requires no knowledge of plant dynamics, is fuzzy logic control (FLC).¹¹ This, coupled with the vagueness and subjectivity of thermal comfort in practice, make fuzzy logic well suited for the evaluation and control of thermal sensation as a fuzzy concept in which the comfort range can be evaluated as a fuzzy range rather than an isolated comfort variable.

The PMV-based fuzzy logic controller investigated in this work starts with the evaluation of the predicted mean vote level and compares this with the required comfort range in order to arrive at a linguistic definition of the comfort sensation. The controller then adjusts the air temperature set point in order to satisfy the required comfort level given the prevailing values of other comfort variables contributing to the comfort sensation. The objectives of this work are thus:

- To develop a model sufficient for investigating the comfort sensation control of the heating system in a building space.
- To develop a control strategy which responds to the essentially subjective basis of comfort sensation.
- To compare the developed control strategy with a conventional method of building space heating control.

2 System model

The dynamics of a building space depend on external microclimate variables, building construction, user influences (e.g., adventitious internal heat generation) and the imposed HVAC

plant. Thermal response modelling of building spaces has received widespread attention over the past 30 years or so, however, the treatment of this problem over the relatively short time periods of importance in control system design and synthesis has received very limited attention. Particular to this problem is a sufficiently accurate description of the building envelope that is computationally efficient at those time intervals necessary for fully dynamic HVAC plant participation.

A model which addresses the main features of this problem is described elsewhere,^{12,13} and adapted for the specific purpose of this work in the following. In principle, three adaptations (besides internal air temperature) were needed in order to prosecute a full thermal comfort sensation analysis but only two of these were incorporated. The three adaptations were mean radiant temperature; relative humidity; and mean relative air velocity. Only the first two were incorporated in the model developed previously since it was assumed that for the heated and naturally ventilated case of interest in this work, that mean relative air velocity (besides being difficult to evaluate dynamically) would be insignificant in most applications.

2.1 Mean radiant temperature

The mean radiant temperature has a significant influence on the body's rate of heat loss and thus its comfort state as defined by the Fanger PMV.^{1,14} Calculation of the mean radiant temperature is complicated by the non-uniform 'view' that the body has of the various surfaces making up a room space. Thus an approximation has been used in the present work, and the mean radiant temperature has been calculated by the following equation based on an area-weighted mean in which the index nc refers to the number of instruction elements involved:

$$T_{mrt} = \frac{\sum_1^{nc} A_j T_j}{\sum_1^{nc} A_j} \quad (1)$$

In practice, most building spaces experience asymmetry in the radiant field at least to some

extent. This is particularly evident when the following prevail (either individually or in combination):

- large spaces;
- irregularly shaped spaces;
- where there is a high degree of glazing;
- where bare heating surfaces form the main method of space heating.

Accounting for these conditions in the assessment of T_{mrt} is feasible in theory but not easy in a practical situation in which a single point measurement is generally used to inform control. Part of the problem is concerned with the point of measurement since the occupant sensation of comfort is spatially dependent. In small spaces this is not significant and in a large space it can be dealt with by dividing the space into a number of rectilinear sub-spaces with a point of measurement in each. A further possibility for those spaces exhibiting one or more of the features mentioned above is to implement a model-assisted strategy in which a thermal model of the space is used to offset measurements made at a single point. None of these avenues have been explored in the present work and form the basis of further work in the field.

2.2 Relative humidity

Relative humidity in the space is calculated using standard psychrometric properties of air.^{15,16} Details of the algorithm used can be found in Appendix A. The uniformity of this parameter within the space is again an issue (see above concerning T_{mrt}) however in most cases the air moisture content (on which the relative humidity is dependent together with prevailing air temperature) will be well mixed unless the space is very large. In any case the relative humidity is less influential on overall comfort sensation than is the case with temperature variables. Again, non-uniformity in relative humidity is not considered in the present work.

2.3 Input data

Input data for the adapted system model were based on a space in a campus building at the

University of Northumbria. The building exhibits relatively high thermal capacity on account of its traditional construction and the heating system comprises hot water natural convectors with local feedback control.

3 Thermal comfort indices

The thermal comfort sensation is expressed using Fanger's predicted mean vote (PMV) and percentage persons dissatisfied (PPD)¹ in which the environmental factors of influence are room air temperature, relative humidity, mean radiant temperature, and air velocity. In the present work, a constant mean was used for the air velocity. In addition, there are human factors associated with activity level, and the thermal resistance of clothing. The relationship between PMV, PPD and the thermal sensation of the occupant is summarized in Table 1¹ based on a neutrality at zero PMV (positive when the thermal sensation is 'warm' or 'hot' and negative

when 'cool' or 'cold'. The PPD is estimated to be 5% when the PMV is zero, and the target indoor temperature is set with respect to this point.

4 Conventional comfort-based control

In order to identify a reference performance for a comfort-based control strategy, a conventional approach was first developed based on a proportional-plus-integral-plus-derivative (PID) controller, a method commonly used in space heating control.^{17,18} The resulting controller and feedback path were added to the adapted system model as summarized in Figure 1. The controlled variable (PMV) is calculated at each time step from prevailing values of room air temperature, relative humidity and mean radiant temperature with the room air velocity, activity and clothing levels treated as constants. This is compared with a reference value of PMV and the resulting error is applied to the controller. External temperature, solar radiation and casual heat gains act as disturbances, as shown in Figure 1. The output of the PID controller is given by:

$$u(t) = k_p e(t) + k_i \int_0^t e(t) + k_d \frac{de(t)}{dt} \quad (2)$$

Where $e(t)$ is the error, $u(t)$ is the control signal and k_p , k_i , k_d are proportional, integral and derivative gain constants, respectively.

The initial parameters of the controller were based on those actually in use in the building space to which the model was applied (see

Table 1 Relationship between PMV, PPD and thermal sensation¹

PMV	Thermal sensation	PPD (%)
+3	Hot	100
+2	Warm	75
+1	Slightly warm	25
0	Neutral	5
-1	Slightly cool	25
-2	Cool	75
-3	Cold	100

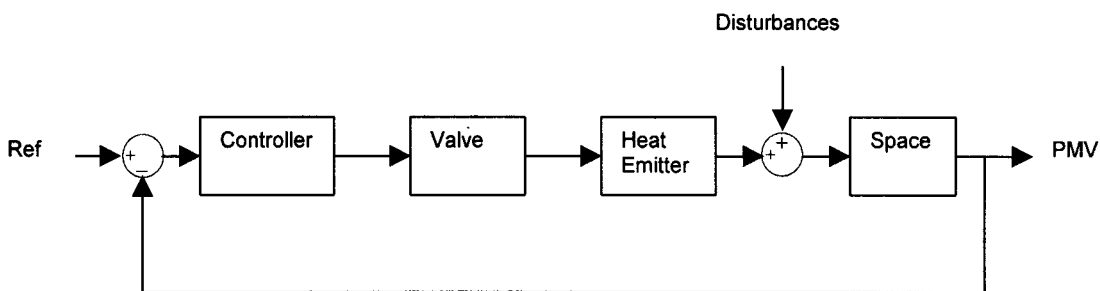

Figure 1 Closed loop system

Section 2.3), these values being 0.1K^{-1} , $0.01\text{K}^{-1}\text{s}^{-1}$, and 0.5sK^{-1} (representing k_p , k_i , k_d respectively). This produced a reasonable response but with overshoot (Figure 5), leading to sub-optimal thermal comfort and unnecessary use of energy.

A tuning algorithm was adopted to adjust the controller parameters in order to eliminate this overshoot. The MATLAB Non-linear Control Design (NCD) Blockset was used¹⁹ – a gradient-based optimization designed to minimize a cost function (i.e., a weighted maximum constraint violation of the constrained (control) variable) with reference to perturbed values of the tunable variables (controller parameters). To give initial estimates of the controller parameters, an error mapping method was used based on the initial parameters given above as shown in Figures 2, 3, and 4. Using the initial mapped values from within

the planes of minimum normalized error to initiate the tuning algorithm, tuned controller parameters of 1.527K^{-1} , $0.005\text{K}^{-1}\text{s}^{-1}$, and 0.050sK^{-1} respectively were obtained for k_p , k_i , k_d . In this way, the initial mapping resulted in substantial reductions in computational effort needed by the tuning algorithm. The response of the system under tuned PID controller is shown in Figure 5 showing an improvement over the existing case.

5 Fuzzy logic control (FLC)

Under well-tuned PID control, performance is excellent within the narrow operating range within which the plant was tuned as is evident above. Once the plant operating region changes significantly (e.g., as a result of a change in season), then the need for retuning becomes evident. Also, it is not possible to adequately

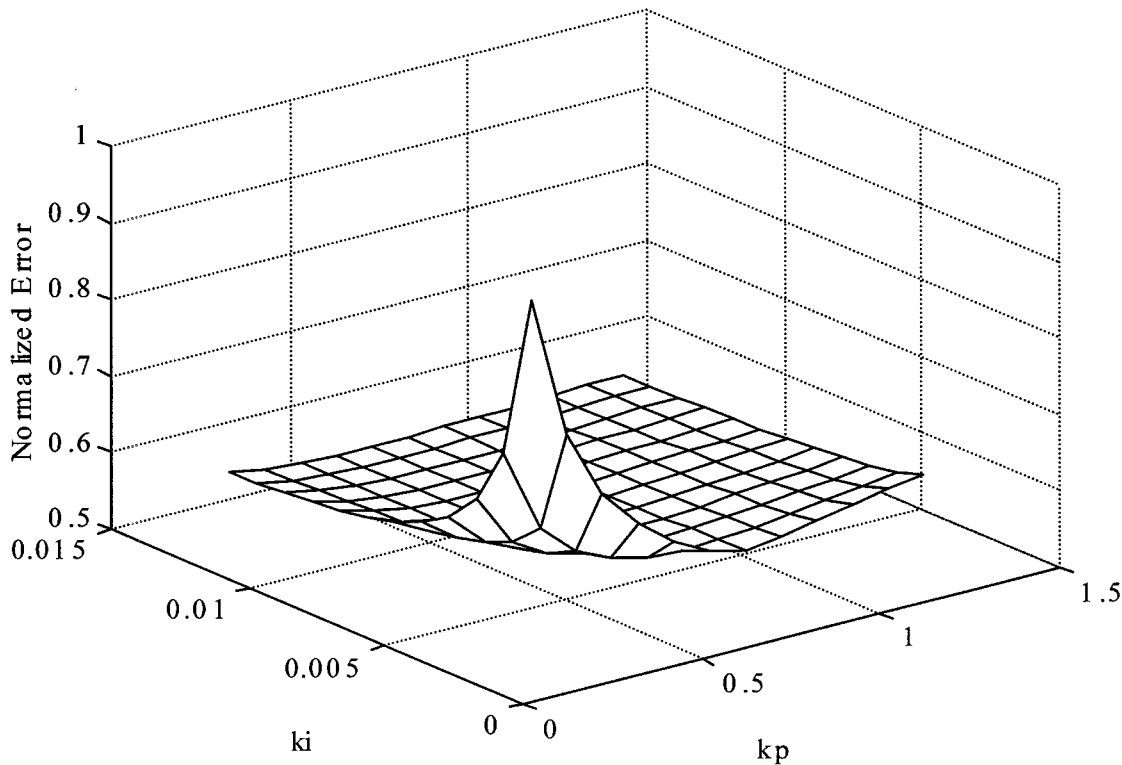

Figure 2 Normalized error versus k_p , k_i

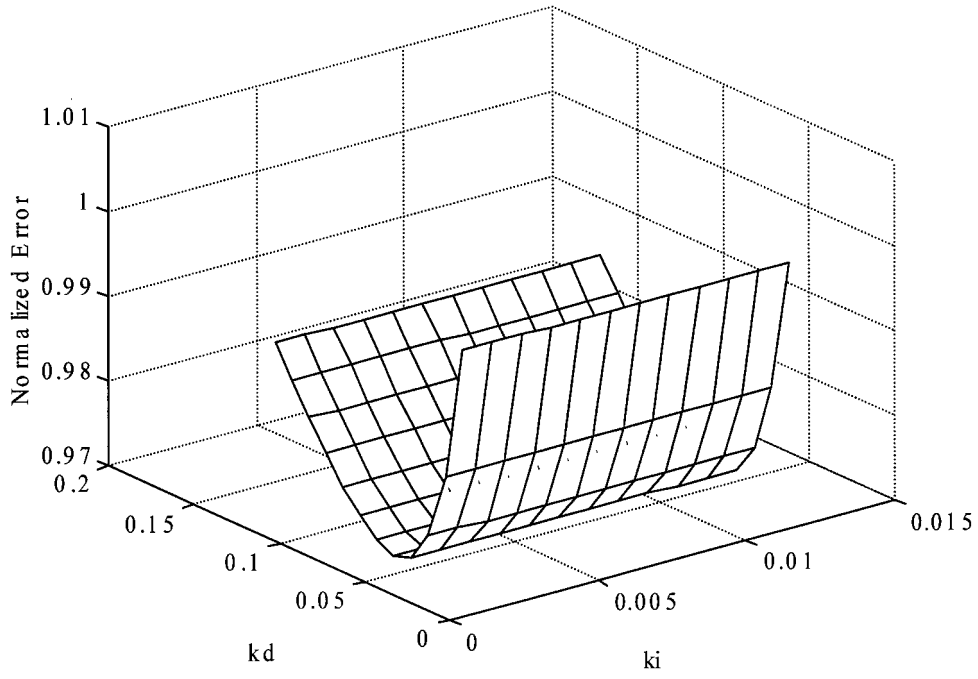

Figure 3 Normalized error versus k_d, k_i

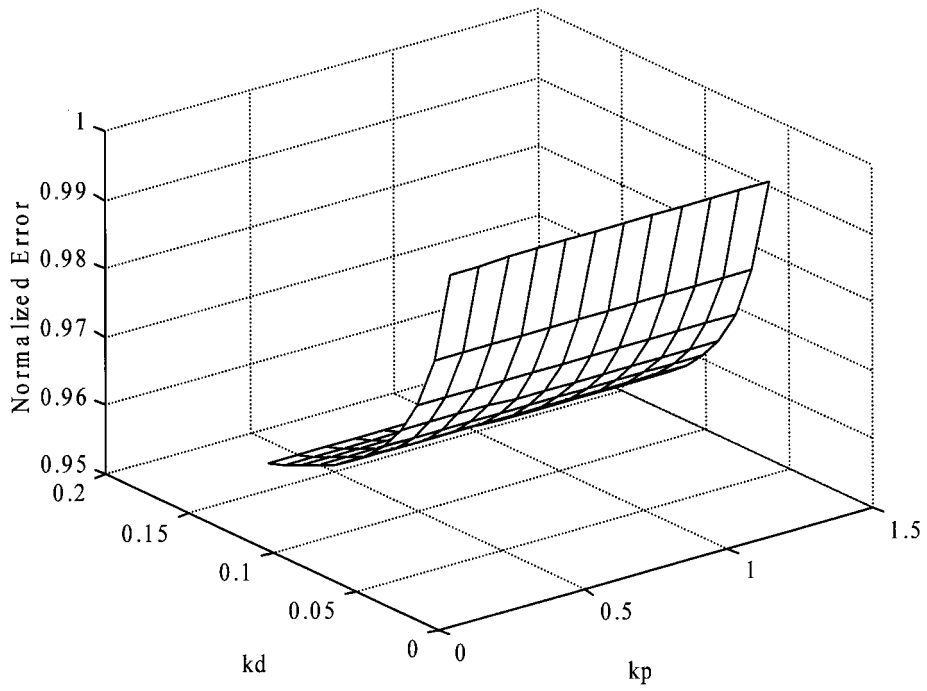

Figure 4 Normalized error versus k_d, k_p

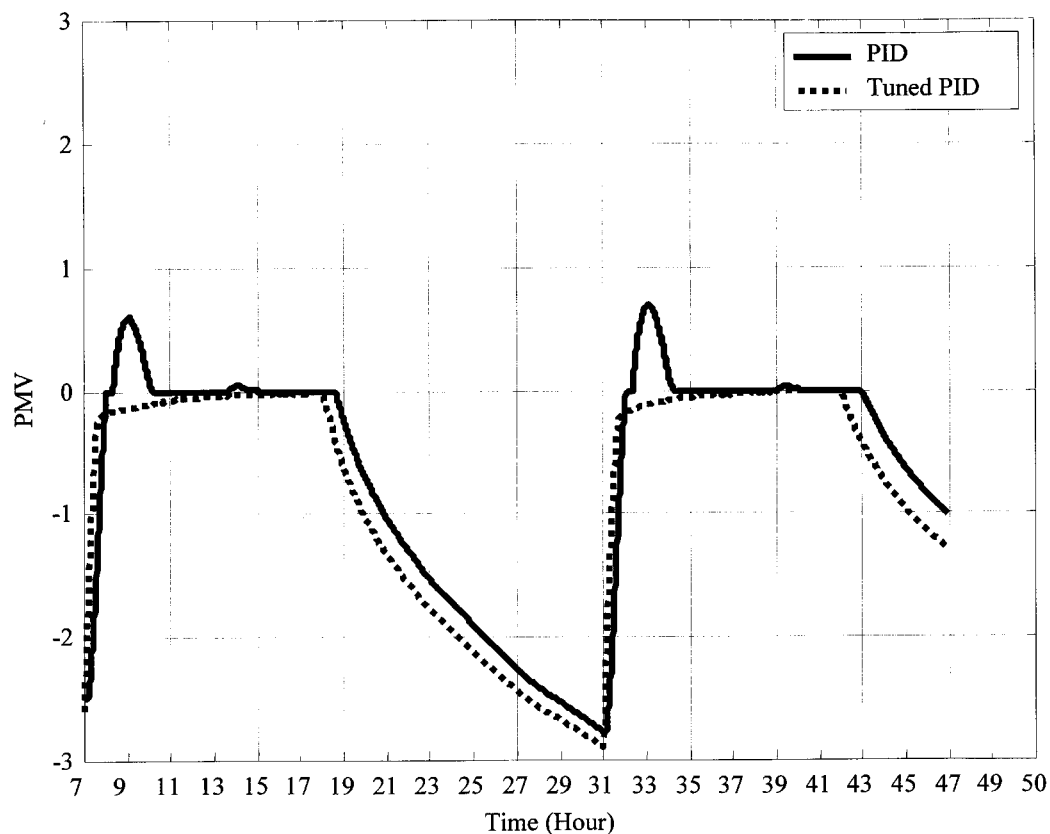

Figure 5 Closed loop response with PID control

generalize the required parameter specification for different applications – for example a PID controller optimized for the control of heating in a higher thermal capacity space will be sub-optimal and possibly even unstable in a low thermal capacity space. Similar difficulties arise with the wide choice of heating systems that can be applied. In addition, in the case of comfort control, a desired comfort sensation will vary with both application and season and is, in any case, subjective (Table 1). One solution is a controller that can respond to this essentially subjective problem with experiential information about plant response and user requirements. A fuzzy logic controller has the potential to meet these needs.

In this section the basic structure of the fuzzy logic controller applied to comfort control prob-

lems will be described. More fundamental information can be found in the literature.^{20–23} The static fuzzy controller consists of four main functional blocks (Figure 6): fuzzification interface; fuzzy control rules; inference engine, and defuzzification interface.

5.1 Fuzzification interface

The fuzzification interface consists of the following operations:

- (1) Performs a scale mapping that transfers the input variable ranges into a corresponding universe of discourse (quantization/normalization).
- (2) Performs the fuzzification strategy that converts crisp input data into suitable

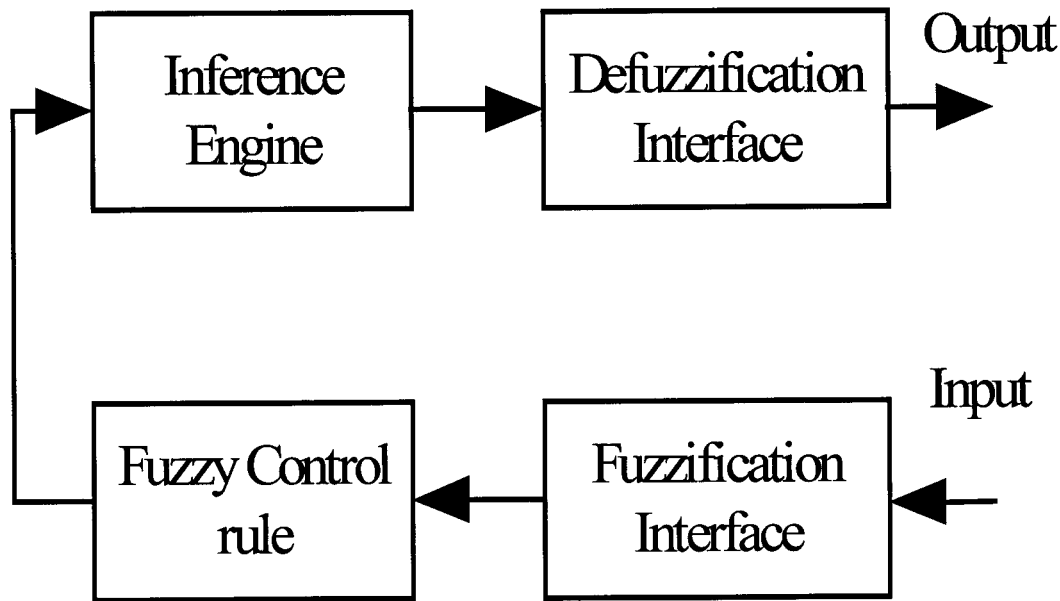

Figure 6 Structure of a fuzzy logic controller

linguistic variables, which may be viewed as labels of fuzzy sets.

The fuzzification strategy converts the crisp input data into fuzzy sets (linguistic variables) such as, cold (*COLD*), cool (*COOL*), slightly cool (*SCOOOL*), neutral (*NEUT*), slightly warm (*SWARM*), warm (*WARM*), and hot (*HOT*). The fuzzification action consists of a set of analogue membership functions, describing the input linguistic terms. The membership function can be of a variety of shapes (e.g., triangle, trapezoid, etc.).

When building a fuzzy controller, one of the first questions which arises, after having chosen the inputs, is how many fuzzy sets will be needed and how the fuzzy sets should be divided on the universe of discourse of the inputs. More or less standard types of fuzzy sets on a universe of discourse of controllers are shown in Figure 7(a) and (b).

The choice of membership functions used

depends on the problem to be dealt with and the choice of the number of fuzzy sets and how those fuzzy sets are divided over the universe of discourse depends generally on how the controller output should be related to the controller input. For example, designing a fuzzy controller for controlling a non-linear process requires knowledge of the non-linearity of the process. There is no standard design scheme that can be employed to choose the number and position of the fuzzy sets, and too few people realize that this is a problem.

The overlapping of fuzzy sets together with fuzzy inference and defuzzification result in interpolation. If the membership functions are convex and normal and the sets are a fuzzy partition, then the interpolation depends only on the nearest surrounding characteristic set of points and each characteristic point is uniquely defined by a fuzzy rule. This is because there are no more than two overlapping membership functions at any point on the universe of discourse.

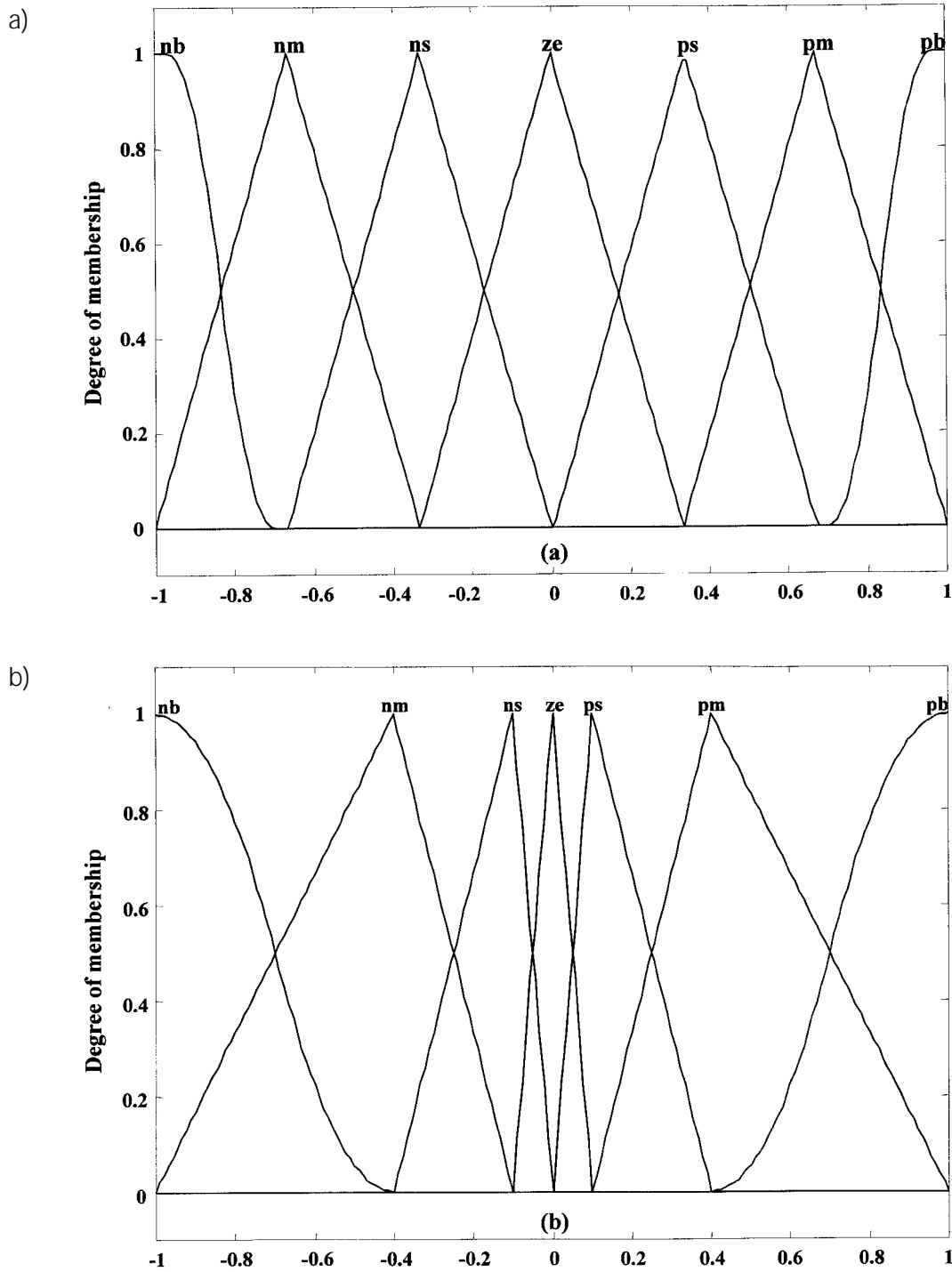

Figure 7 Types of membership functions: (a) linear and (b) logarithmic

5.2 Fuzzy control rules

The dynamic behaviour of a fuzzy system is characterized by a set of imprecise conditional statements, which form a set of decision rules. The process can be expressed linguistically as a set of linguistic decision rules of the form: If (*Conditions are satisfied*) Then (*Action can be inferred*).

There are four ways to derive fuzzy control rules:^{25,26}

- From experiential knowledge of the plant behaviour and control problem.
- By modelling or observing a human operator's manual interpretation of the problem.
- From a model of the plant behaviour and control problem.
- Self-learning and adaptation by the controller (self-organization).

5.3 Inference

There are in general four methods of fuzzy reasoning.²⁴ Mamdani's minimum operation method is the most common, involving two functions:

- 1) Determine for any fuzzy controller input which rules are applicable.
- 2) Determine the fuzzy control action by using fuzzy reasoning.

5.4 Defuzzification strategies

At the output of inference the process is a fuzzy set (i.e., for example, Figure 7). A non-fuzzy control signal (i.e., a crisp value) can be established through a defuzzification. There are several methods for defuzzifying to a crisp value²⁵ of which the centre of gravity method (COG) is the most commonly used. This method is based on taking the aggregate of the fuzzy outputs from each rule, weighted by their grades of fuzzy input set membership.

6 A PMV-based fuzzy logic controller

The PMV-based fuzzy logic controller proposed here evaluates the predicted mean vote (PMV) level and, if this level is out of the comfort range, provides the air temperature set point that should

be used by the plant in order to create indoor thermal comfort. The controller, making it easy to apply and generic to a wide range of heating control problems uses a linguistic description of the thermal comfort sensation. Overlapping triangular membership functions were used for input (fuzzification) and output (defuzzification) of the fuzzy system.

The input membership functions were defined by assigning seven fuzzy input sets to the variables; (*COLD*, *COOL*, *SCOOOL*, *NEUT*, *SWARM*, *WARM*, and *HOT*), as shown in Figure 8.

Seven fuzzy sets were ascribed to the output variables; (*FC*, *CL*, *SCL*, *MDL*, *SOP*, *OP*, *FO*) to form the output membership functions as shown in Figure 9.

According to the number of the fuzzy sets of the input and the output, seven fuzzy rules may be defined as follows:

- R1: If PMV is '*COLD*' Then Vp is '*FO*'
 R2: If PMV is '*COOL*' Then Vp is '*OP*'
 R3: If PMV is '*SCOOOL*' Then Vp is '*SOP*'
 R4: If PMV is '*NEUT*' Then Vp is '*MDL*'
 R5: If PMV is '*SWARM*' Then Vp is '*SCL*'
 R6: If PMV is '*WARM*' Then Vp is '*CL*'
 R7: If PMV is '*HOT*' Then Vp is '*FC*'

The relationship between the input and the output of the controller according to these fuzzy rules is shown in Figure 10.

Using Mamdani's minimum operator method for inference, the control action is a fuzzy set, which requires a defuzzification strategy to obtain a crisp control signal. The COG method was used to convert from fuzzy values to crisp values, forming the actual control signal, which can then be applied to the heating valve.

The overall system (building, heating system, and outdoor climate files) with the PMV based fuzzy logic controller and, for comparison, the PID-based comfort controller is shown in Figure 11. A switch has been added to the model, before the non-linear valve, to select between PID and fuzzy logic control actions. Two different outdoor climates have been used; one in February (a winter month) and the second in April (a spring month).

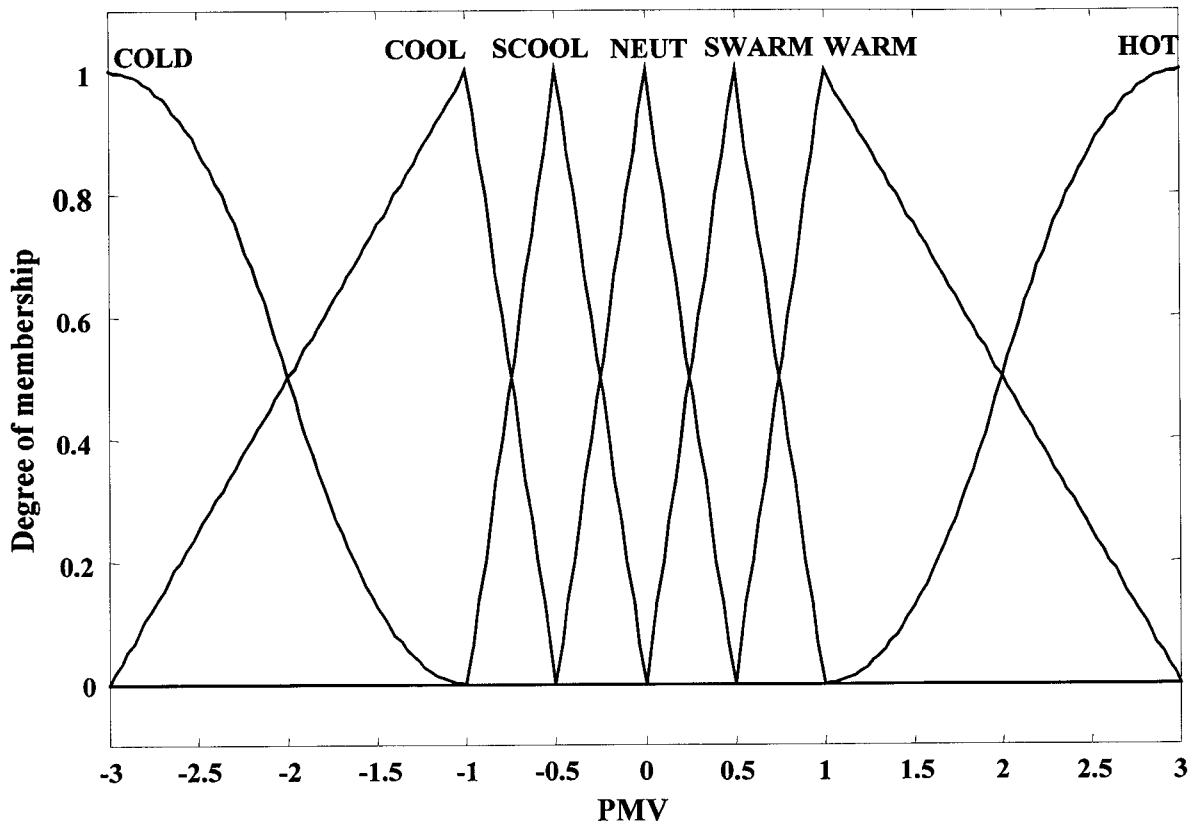

Figure 8 Membership functions of the fuzzy controller input

The calculation of the predicted mean vote (PMV) and the predicted percentage of persons dissatisfied (PPD) is determined using a MATLAB function based on three inputs from the simulation model; the internal air temperature, the mean radiant temperature, and the relative humidity of the internal air. Because the activity and clothing levels are application-dependent, these values were entered as constants.

The resulting PMV based fuzzy logic controller was applied to the building space and its heating system. Figure 12, shows the system response under tuned PID and PMV-based FLC. As can be seen, the performance of the PMV based FLC is superior to PID controller in terms of reference point tracking. Results were extended over a 7-day cycle of space heating in

typical winter conditions and the energy demands in both cases were integrated to reveal an energy saving of approximately 20% due to the PMV-based FLC when compared with conventional tuned PID control.

In order to test the general applicability of the two control systems, the building construction data were changed to those representing a very low thermal capacity structure while keeping the overall thermal transmittance of each element constant and the controller specifications remained unchanged. This would have the effect of making the system much more responsive thus challenging the PID controller originally tuned for a high thermal capacity application. Results, shown in Figure 13, reveal that the fuzzy controller maintains excellent tracking of the

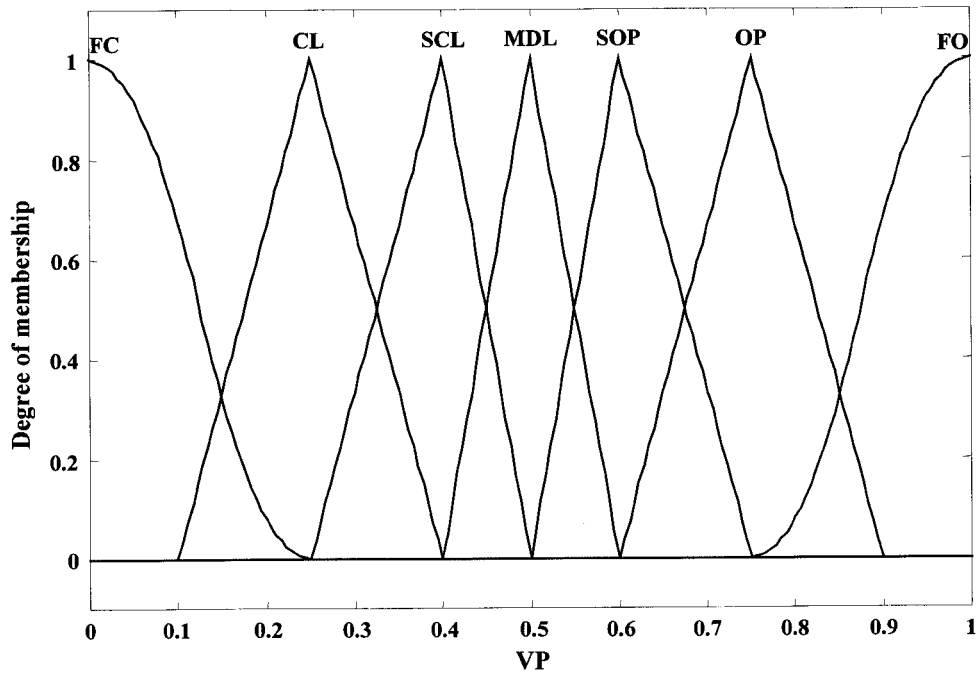

Figure 9 Membership functions of the fuzzy controller output

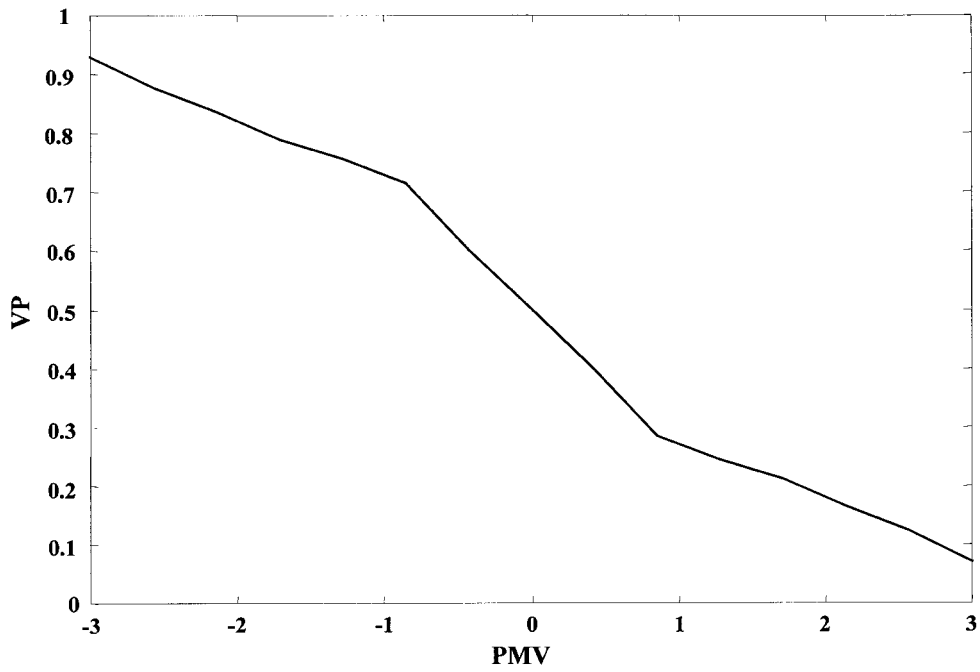

Figure 10 Input/output relationships for the fuzzy controller

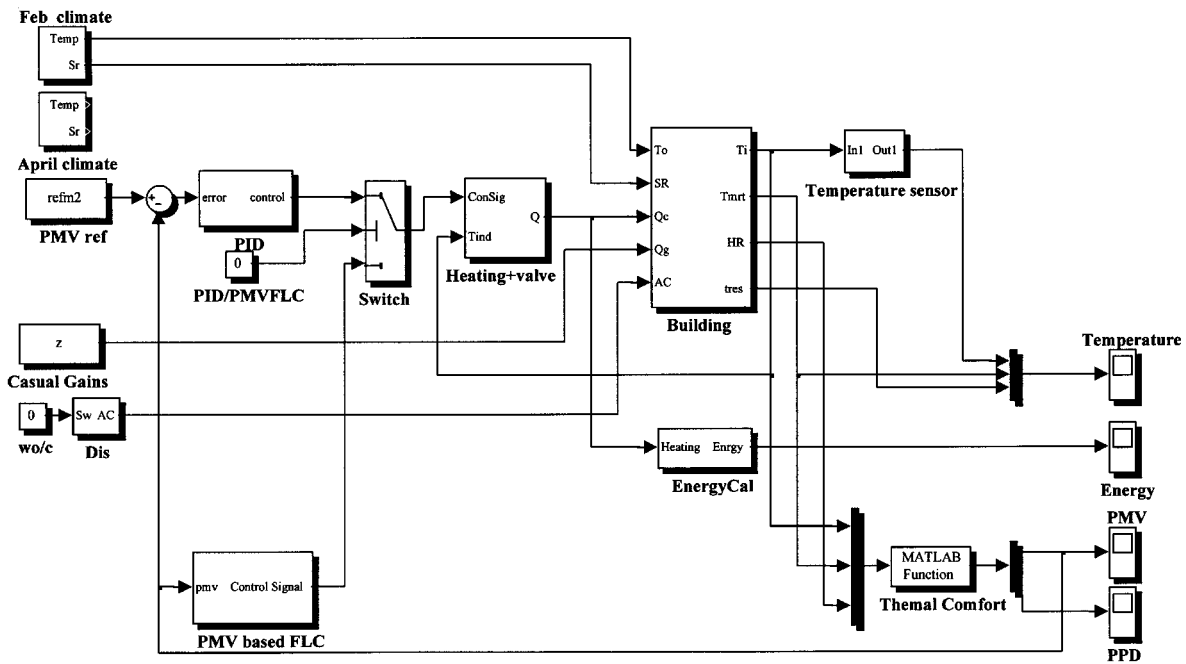

Figure 11 Overall model of the building, heating system and controllers

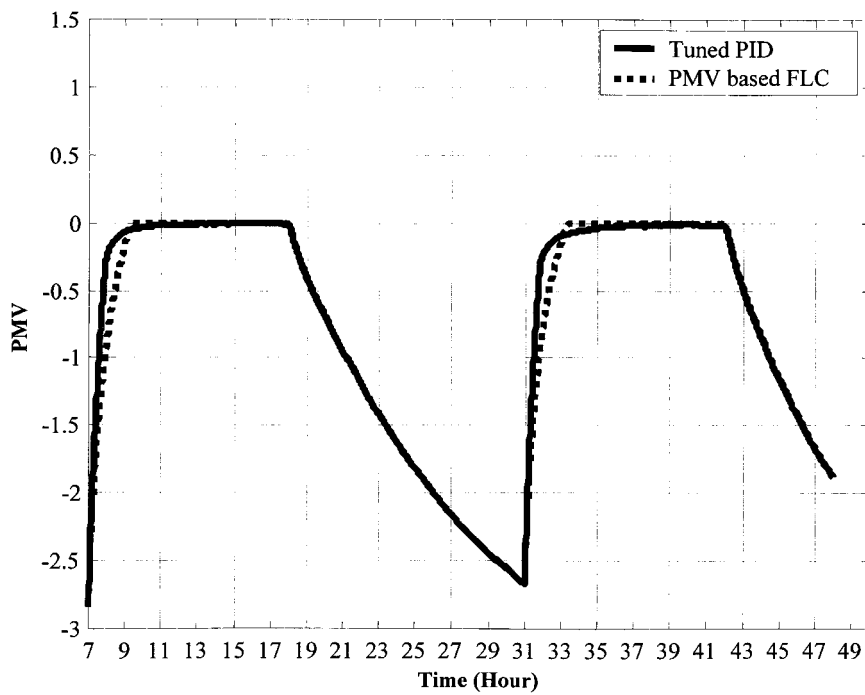

Figure 12 Comparison of tuned PID and PMC-based FLC

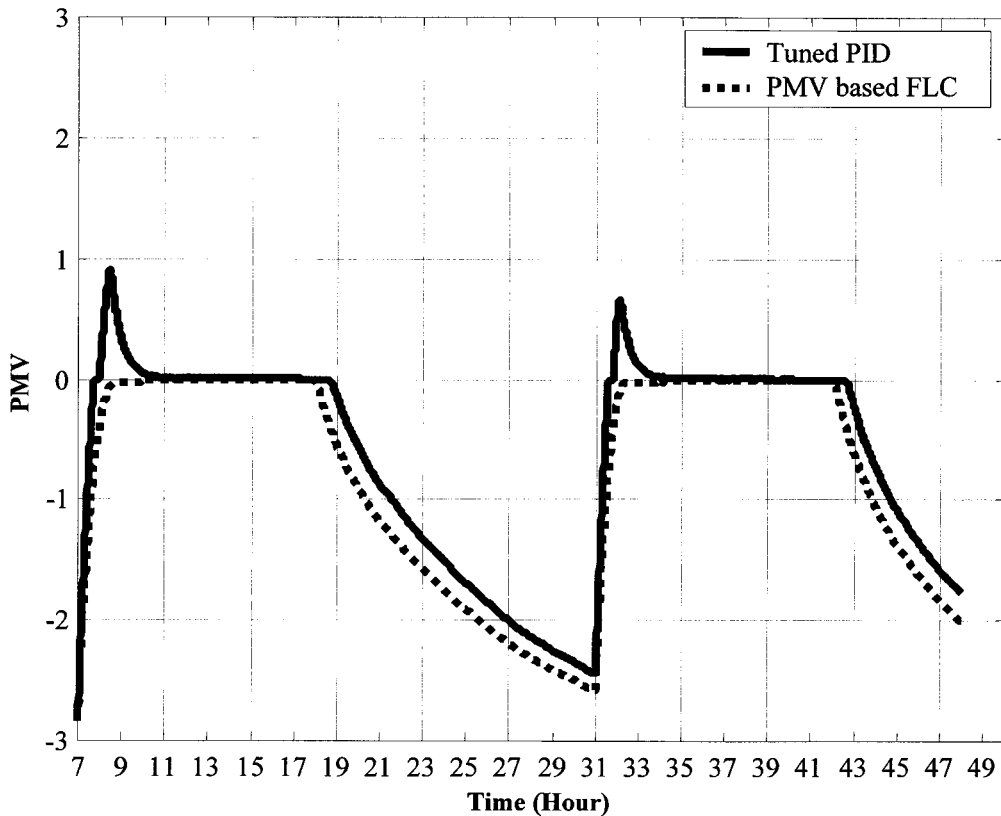

Figure 13 Low thermal capacity building with PID control and PMC-based FLC

reference condition whereas the tuned PID gives a reasonable response but with significant overshoot. Thus the robustness characteristic of the PMV-based FLC is superior to that of the PID controller. In practice, the PID controller would either have to be tuned for each individual application, or tuned for an expected least-damped case (in which case it would behave sub-optimally in all other applications) whereas the PMV-based FLC would not require this.

7 Conclusions

In this work, a control strategy has been developed for the space heating of a building space in which the comfort sensation as quantified by predicted mean vote forms the control variable. Difficulties associated with the lack of generality inherent in

PID control of this problem are identified and an alternative strategy based on a fuzzy logic controller (FLC) is developed. There is a natural appeal in this in that the essentially subjective comfort control problem can be easily mapped onto a universe of discourse of input fuzzy sets and the associated inference which ultimately forms a required control action can be carried out qualitatively. The resulting FLC is compared with a PID controller tuned to give optimal performance for a given case, consisting of a building space with high thermal capacity. A further comparison is then made using the same controller specifications but with a low thermal capacity building space. Results show that the FLC gives better control tracking and robustness than the PID controller for both applications. This work has addressed the extremes of building space thermal capacity in arriving at these

conclusions and further work needs to be done on the applicability of the results to a wider range of construction types, heating system types (and modes) and microclimate conditions. It is likely that some degree of self-adaptation will therefore be necessary and a neuro-fuzzy approach is presently being actively explored. Further work is also needed on the essentially spatially-variable nature of certain variables which contribute to comfort sensation (Sections 2.1, 2.2). One area meriting further work is the use of model-assisted compensation in which a thermal model is used to predict the spatial distribution of the variables of interest with reference to a single point of measurement. From this, the measurement can subsequently be adjusted to account of non-uniformity within the space.

Acknowledgements

The authors would like to thank the Northumbria Photovoltaics Application Centre at the University of Northumbria and Meteorological Office (Academic Research Section) in London, for supplying the weather data used for this work. Also, the authors express their gratitude to the Egyptian government for financial support.

References

- 1 Fanger PO. *Thermal comfort, analysis and application in environmental engineering*. McGraw-Hill, 1972.
- 2 Gagge AP, Fobelets AP, Berglund LG. A standard predictive index of human response to the thermal environment. *ASHRAE Trans* 1986; 92: 709–31.
- 3 Sherman M. A simplified model of thermal comfort. *Energy and Buildings* 1985; 8: 37–50.
- 4 Hamdi M, Lachiver G, Michaud F. A new predictive thermal sensation index of human response. *Energy and Buildings* 1999; 29: 167–78.
- 5 ASHRAE Fundamentals, chap. 8, ASHRAE, Atlanta, GA, 8.1–8.29, 1993.
- 6 International Standard ISO 7730. Moderate thermal comfort control environments – Determination of the PMV and PPD indices and specification of the conditions for thermal comfort, 1994.
- 7 Auliciems A. Thermobile controls for human comfort. *The Heating and Ventilation Engineer* 1984; 31–3.
- 8 Fountain M, Brager G, Arens E, Bauman F, Benton C. Comfort control for short-term occupancy. *Energy and Buildings* 1994; 21: 1–13.
- 9 Culp CH, Rhodes ML, Krafthefer BC, Listvan M. Silicon infrared sensors for thermal comfort and control. *ASHRAE Journal* 1993; 38–42.
- 10 MacArthur JW. Humidity and predicted mean vote based comfort control. *ASHRAE Trans*. 1986; 1: 5–17.
- 11 King PJ, Mamdani EH. The application of fuzzy control systems to industrial processes. *Automatica* 1977; 13: 235–42.
- 12 Gouda MM, Danaher S, Underwood CP. Modelling the heating of a building space using Matlab and Simulink. *Proceedings of IMACS Symposium on Mathematical Modelling*, Vienna, 2000; 1: 91–4.
- 13 Gouda MM, Danaher S, Underwood CP. Low-order model for the simulation of a building and its heating system. *Building Serv. Eng. Res. Technol.* 2000; 21: 203–12.
- 14 Dounis AI, Santamouris MJ, Lefas CC, Manolakis DE. Thermal comfort degradation by a visual comfort fuzzy reasoning machine under natural ventilation. *Applied Energy* 1994; 48: 115–30.
- 15 CIBSE Guide part C, section C1.
- 16 *Psychrometrics: theory and practice*. Georgia: American Society of Heating, Refrigerating, and Air-Conditioning Engineers, Inc, 1996.
- 17 ASHRAE, *Systems handbook*. Georgia: ASHRAE Inc, 1984.
- 18 Haines RW. *HVAC systems design handbook*. USA: TAB Books, 1988.
- 19 MathWorks. Matlab user manual. MA: Natick, 1993.
- 20 Lee CC. Fuzzy logic in control systems: fuzzy logic controller part 1. *IEEE Trans. System Man. Cyb.* 1990; 20.
- 21 Lee CC. Fuzzy logic in control systems: fuzzy logic controller part 2. *IEEE Trans. System Man. Cyb.* 1990; 20.
- 22 Gouda MM, EL-Ghotmy M, EL-Rabaie N, Sharaf MM. Fuzzy logic control for a turbogenerator. *Proceedings 5th International Conference on Artificial Intelligence Applications (ICAIA)*, Cairo, Egypt, 1997; 1: 592–601.
- 23 Gouda MM, Danaher S, Underwood CP. Fuzzy

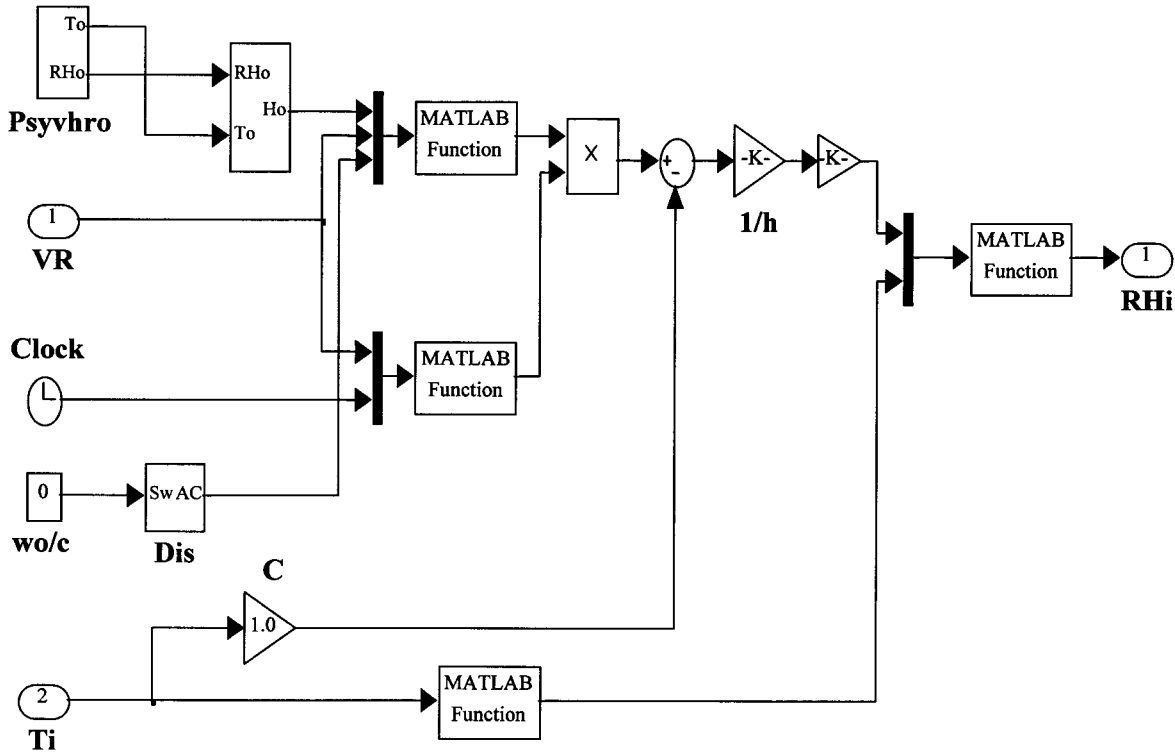

Figure A1 Model realization for the internal relative humidity

- logic controller versus conventional PID controller for controlling indoor temperature of a building space. *Computer Aided Control System Design (CACSD 2000) Conference*. Salford University, UK, 2000.
- 24 Mamdani EH. Application of fuzzy algorithms for control of simple dynamic plant. *Inst. Elect. Eng. Contr. Sci.* 1974; 121: 1585–8.
 - 25 Sugeno M, Takagi T. Fuzzy identification of systems and its applications to modeling and control. *IEEE Trans. Syst. Man. Cyb.* 1985; SMC-15, 116–32.
 - 26 Pedrycz W. *Fuzzy control and fuzzy systems*. USA: JohnWiley & Sons Inc, 1989.

Appendix A

To calculate the relative humidity of a building space, the internal air enthalpy (H_r) is first calculated from a room air total heat balance as follows:

$$M \dot{H}_r = Q_l + m_o(H_o - H_r) \quad (A1-1)$$

The outdoor air enthalpy (H_o) is calculated using the following set of equations:¹⁶

$$g_{ss}(T_o) = \frac{0.624 P_{w_{sat}}(T_o)}{101.325 - 1.004 P_{w_{sat}}(T_o)} \quad (A1-2)$$

Where $P_{w_{sat}}$ is obtained from either equation A1-3 or A1-4:

The saturation pressure $P_{w_{sat}}$ over ice ($-100 \leq T < 0$):

$$\ln(P_{w_{sat}}) = \sum_{i=0}^5 a_i T^{i-1} + a_6 \ln(T) \quad (A1-3)$$

in which,

$$\begin{aligned} a_0 &= -5674.5359 & a_1 &= 6.3925247 \\ a_2 &= -0.9677843 \times 10^{-2} \end{aligned}$$

$$\begin{aligned} a_3 &= 0.622157 \times 10^{-6} & a_4 &= 0.20748 \times 10^{-8} \\ a_5 &= 0.948402 \times 10^{-12} & a_6 &= 4.1635019. \end{aligned}$$

The saturation pressure over water ($0 \leq T \leq 200$):

$$\ln(Pw_{sat}) = \sum_{i=-1}^3 b_i T^{i-1} + b_4 \ln(T) \quad (A1-4)$$

Where:

$$\begin{aligned} b_{-1} &= -5800.2206 & b_0 &= 1.3914993 \\ b_1 &= -0.048640239 & b_2 &= 0.41764768 \times 10^{-4} \\ b_3 &= -0.14452093 \times 10^{-7} & b_4 &= 6.5459673. \end{aligned}$$

From the model-input value of external air relative humidity (ϕ_{ext}), the mass of water vapour of the mixture (g) of the external air is obtained from:

$$\phi_{ext} = 100g(T_o) / g_{ss}(T_o) \quad (A1-5)$$

Thus the enthalpy of the outdoor air (H_o) is given by:

$$H_o = hg(T_o) + CT_o \quad (A1-6)$$

The mass of water vapour in the internal air ($g(T_i)$) is given by:

$$g(T_i) = (H_r - CT_i) / h \quad (A1-7)$$

Hence the percentage saturation (to which the relative humidity may be taken as a close approximation) is obtained:

$$\phi_i = 100g(T_i) / g_{ss}(T_i) \quad (A1-8)$$

Appendix B

The thermal comfort indices (PMV and PPD) are calculated as follows:¹

$$\begin{aligned} PMV &= (0.352 \exp(-0.42Met) + 0.032) \\ &\times (Met - 0.35(43 - 0.061Met - pv) \\ &- 0.42(Met - 50) - 0.0023Met(44 \\ &- pv) - 0.0014Met(34 - T_i) \\ &- 3.4 \times 10^{-8} f_{cl}((T_{cl} + 273)^4 - T_{mrt} \\ &+ 273)^4 - f_{cl}h_c(T_{cl} - T_i)) \quad (B1-1) \end{aligned}$$

Where T_{cl} is calculated iteratively from the following equation:

$$\begin{aligned} T_{cl} &= 35.7 - 0.032Met - 0.18Icl(3.4 \\ &\times f_{cl}((T_{cl} + 273)^4 - T_{mrt} + 273)^4) \\ &+ f_{cl}h_c(T_{cl} - T_i) \quad (B1-2) \end{aligned}$$

$$\begin{aligned} PPD &= 1 - 0.95 \exp(-0.003353PMV^4 \\ &- 0.2179PMV^2) \quad (B1-3) \end{aligned}$$