

Thrombin exerts a dual effect on stimulated adenylate cyclase in hamster fibroblasts, an inhibition via a GTP-binding protein and a potentiation via activation of protein kinase C

Isabelle MAGNALDO,* Jacques POUYSSÉGUR and Sonia PARIS

Centre de Biochimie, C.N.R.S., Université de Nice, Faculté des Sciences, Parc Valrose, 06034 Nice Cédex, France

Previous studies in Chinese-hamster fibroblasts (CCL39 line) indicate that an important signalling pathway involved in thrombin's mitogenicity is the activation of a phosphoinositide-specific phospholipase C, mediated by a pertussis-toxin-sensitive GTP-binding protein (G_p). The present studies examine the effects of thrombin on the adenylate cyclase system and the interactions between the two signal transduction pathways. We report that thrombin exerts two opposite effects on cyclic AMP accumulation stimulated by cholera toxin, forskolin or prostaglandin E_1 . (1) Low thrombin concentrations (below 0.1 nM) decrease cyclic AMP formation. A similar inhibition is induced by AlF_4^- , and both thrombin- and AlF_4^- -induced inhibitions are abolished by pertussis toxin. (2) Increasing thrombin concentration from 0.1 to 10 nM results in a progressive suppression of adenylate cyclase inhibition and in a marked enhancement of cyclic AMP formation in pertussis-toxin-treated cells. A similar stimulation is induced by an active phorbol ester, and thrombin-induced potentiation of adenylate cyclase is suppressed by down-regulation of protein kinase C. Therefore, we conclude that (1) the inhibitory effect of thrombin on adenylate cyclase is the direct consequence of the activation of a pertussis-toxin-sensitive inhibitory GTP-binding protein (G_i), possibly identical with G_p , and (2) the potentiating effect of thrombin on cyclic AMP formation is due to stimulation of protein kinase C, as an indirect consequence of G_p activation. Our results suggest that the target of protein kinase C is an element of the adenylate cyclase-stimulatory GTP-binding protein (G_s) complex. At low thrombin concentrations, activation of phospholipase C is greatly attenuated by increased cyclic AMP, leading to predominance of the G_i -mediated inhibition.

INTRODUCTION

Proteolytically active α -thrombin initiates proliferation in a variety of fibroblastic cells [1–4], but the mechanisms underlying this mitogenic effect are still poorly understood. One of the earliest events detected in thrombin-stimulated fibroblasts is the activation of a phosphoinositide-specific phospholipase C [5–8], an important signalling pathway leading to the production of the two second messengers inositol 1,4,5-trisphosphate [9,10] and diacylglycerol [11]. Activation of phospholipase C involves a GTP-binding protein, as demonstrated by the GTP-dependence in membrane systems [12,13], the activation by AlF_4^- in intact cells [14], and the sensitivity to pertussis toxin of both thrombin- and AlF_4^- -induced activations in intact cells of the Chinese-hamster lung fibroblast line CCL39 [14,15]. As pertussis-toxin treatment of CCL39 cells strongly inhibits thrombin-induced DNA synthesis and proliferation without affecting mitogenic effects of other growth factors that do not activate phospholipase C, it has been proposed that the phosphoinositide pathway is an essential signalling pathway for thrombin [16].

Adenylate cyclase is another important membrane-bound system involved in signal transduction [17]. Since

thrombin has been reported to inhibit agonist-stimulated adenylate cyclase in platelets [18–20] as well as in 3T3 fibroblasts [21], we have examined in the present study the effects of thrombin on cyclic AMP formation in CCL39 cells, in order to understand better the interactions between the two signalling pathways and to gain further insight into mechanisms of action of growth factors. We report here that thrombin in fact exerts a dual effect on stimulated adenylate cyclase: an inhibitory effect mediated by a pertussis-toxin-sensitive G protein, and an opposite potentiating effect owing to activation of protein kinase C.

EXPERIMENTAL

Cell culture

The Chinese-hamster lung fibroblast line CCL39 (American Type Culture Collection) was maintained in Dulbecco's modified Eagle's medium (DMEM; Gibco) supplemented with 10% (v/v) fetal-calf serum, antibiotics (50 units of penicillin/ml and 50 μ g of streptomycin/ml) and 25 mM- $NaHCO_3$ at 37 °C in air/ CO_2 (19:1). Confluent monolayers arrested in G_0 phase by a 30 h incubation in serum-free DMEM were used throughout this study.

Abbreviations used: DMEM, Dulbecco's modified Eagle's medium; G_i , inhibitory GTP-binding regulatory protein of adenylate cyclase; G_s , stimulatory GTP-binding regulatory protein of adenylate cyclase; G_p , stimulatory GTP-binding regulatory protein of phospholipase C; IBMX, 3-isobutyl-1-methylxanthine; PBt_2 , 4 β -phorbol 12,13-dibutyrate; PGE_1 , prostaglandin E_1 .

*To whom reprint requests should be addressed.

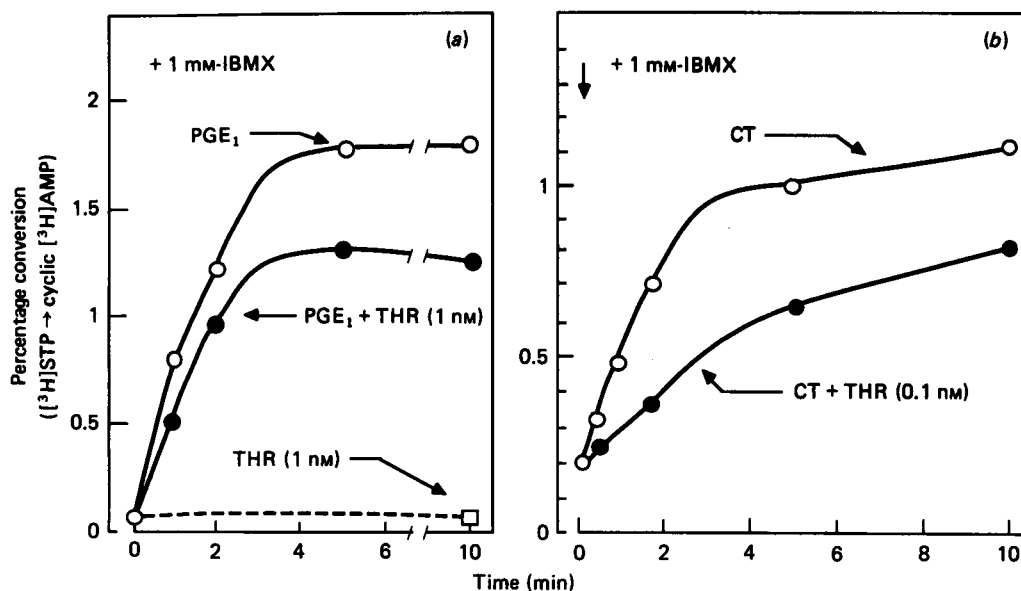

Fig. 1. Time course of thrombin effect on PGE₁- and cholera-toxin-stimulated cyclic AMP accumulation

G₀-arrested cells labelled with [³H]adenine were pretreated for 30 min in Hepes-buffered DMEM with 1 mM-IBMX (a) or 100 ng of cholera toxin/ml (CT, b). At zero time, the cultures received the following additions: (a) 1 μM-PGE₁ (○), 1 nM-thrombin (THR) (□) or 1 μM-PGE₁ together with 1 nM-thrombin (●); (b) 1 mM-IBMX, either alone (○) or together with 0.1 nM-thrombin (●). Formation of cyclic [³H]AMP was determined at the indicated times as described in the Experimental section.

Measurement of phosphoinositide breakdown

Confluent cultures in 35 mm-diam dishes were labelled with [³H]inositol (1 μCi/ml) over the 30 h incubation in serum-free DMEM. Before the start of the experiment, the bicarbonate-buffered medium was replaced by 1 ml of DMEM buffered with 20 mM-Hepes (pH 7.4), containing 1 μCi of [³H]inositol/ml. Cells were equilibrated in this medium for at least 1 h before addition of 20 mM-LiCl and the agents to be tested, as specified in the Figure legends. Incubations were stopped by quickly aspirating the medium, washing the cultures with ice-cold phosphate-buffered saline (142 mM-NaCl, 2.7 mM-KCl, 8 mM-Na₂HPO₄, 1.5 mM-KH₂PO₄, 0.5 mM-MgCl₂ and 0.7 mM-CaCl₂), and adding 0.5 ml of 10% (w/v) HClO₄. After neutralization with KOH and removal of the KClO₄ precipitate, the cell extract was applied to a 0.7 ml column of Bio-Rad anion-exchange resin (AG 1-X8, formate form), essentially as previously described [14,21]. Free inositol, glycerophosphoinositol and total inositol phosphates were eluted with 5 ml of 5 mM-, 5 ml of 40 mM- and 6 ml of 2 M-ammonium formate/formic acid, pH 5, respectively.

Determination of intracellular cyclic AMP

This was done by measuring the conversion of [³H]-adenine nucleotide precursors (primarily [³H]ATP) into cyclic [³H]AMP [22]. Confluent cultures in 35 mm dishes were labelled with [³H]adenine (2 μCi/ml) over the 30 h incubation in serum-free medium. Cells were then rinsed with DMEM buffered with 20 mM-Hepes at pH 7.4, and incubated for 30 min at 37 °C in this medium. Test agents were then added as indicated in the Figure legends, in 1 ml of the same medium. The reaction was stopped by aspiration of the medium and addition of 0.5 ml of ice-cold 5% (w/v) trichloroacetic acid. The acid extracts were then removed and dishes rinsed with an

additional 0.5 ml of 5% trichloroacetic acid. Unlabelled ATP and cyclic AMP (each 1 mM) were added to the resulting pooled acid phases, which were then eluted through sequential chromatography on Dowex and alumina columns as described previously [22]. Cyclic AMP formation was expressed as the percentage conversion of [³H]ATP into cyclic [³H]AMP, as previously described [14]. When pertussis toxin was used, it was added to the culture 5 h before the beginning of the experiment into the medium used to prelabel the cells.

All incubations were performed in duplicate. Values are means ± range; the deviation was less than 4% for data points without error bars.

Materials

Highly purified α-thrombin (2660 NIH units/mg) was generously provided by Dr. J. W. Fenton, II (New York State Department of Health, Albany, U.S.A.). *myo*-[2-³H]inositol and [³H]adenine were from Amersham Corp. Prostaglandin E₁ (PGE₁), isobutylmethylxanthine (IBMX), 4β-phorbol 12,13-dibutyrate (PbT₂), ATP, cyclic AMP, cholera toxin and forskolin were from Sigma. The inactive 4α-phorbol 12,13-dibutyrate was provided by L.C. Services Corp. (Woburn, MA, U.S.A.) Pertussis toxin (islet-activating protein) was purchased from List Biological Laboratories (Campbell, CA, U.S.A.).

RESULTS

Effects of thrombin on PGE₁- and cholera-toxin-induced-cyclic AMP production

As shown in Fig. 1(a), addition of 1 μM-PGE₁ in the presence of the phosphodiesterase inhibitor IBMX caused a rapid increase in cyclic AMP in CCL39 cells, as measured by the conversion of [³H]ATP into cyclic [³H]-

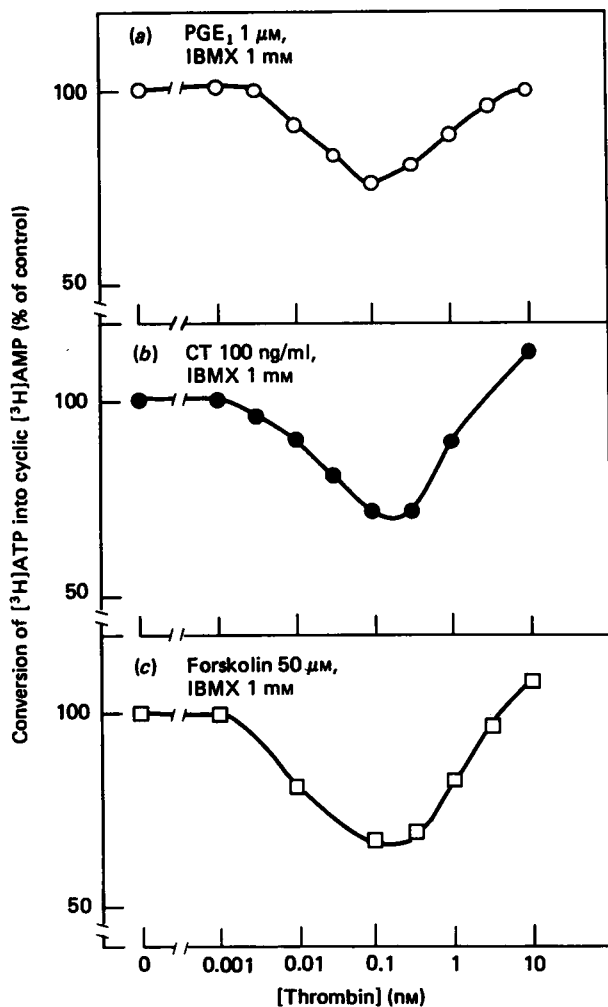

Fig. 2. Concentration-dependence of the effects of thrombin on PGE₁-, cholera-toxin- and forskolin-induced cyclic AMP formation

Cyclic [³H]AMP was measured in every case 5 min after the addition of the indicated concentrations of thrombin. (a) PGE₁ (1 μM) and thrombin were added at the same time, 30 min after the addition of 1 mM IBMX; (b) IBMX (1 mM) was added at the same time as thrombin, after a 30 min pretreatment with 100 ng of cholera toxin (CT)/ml; (c) forskolin (50 μM) was added with thrombin, 30 min after IBMX. Conversions of ATP into cyclic AMP were expressed relative to the control values in the absence of thrombin (100%); 100% corresponds to 1.45% conversion in the presence of PGE₁, 1% in the presence of cholera toxin and 0.84% in the presence of forskolin.

AMP. The maximal accumulation, reached by 5 min, corresponded to a 25-fold increase in cyclic AMP concentration above baseline. Addition of 1 nM- α -thrombin together with PGE₁ resulted in a 30% decrease in both the rate of cyclic AMP production and the plateau amount. IBMX by itself caused only a small increase in intracellular cyclic AMP, by about 2-fold (results not shown), and thrombin had no significant effect on this basal accumulation (Fig. 1a). Fig. 1(b) shows that thrombin likewise inhibited the accumulation of cyclic AMP promoted by cholera toxin. Treatment of CCL39 cells for 30 min with 100 ng of cholera toxin/ml resulted in an approx. 4-fold increase of cellular cyclic

AMP over basal, and addition of IBMX caused a rapid and striking further increase, which was markedly inhibited by 0.1 nM-thrombin.

Biphasic concentration-dependence of thrombin effects on cyclic AMP formation

To analyse the concentration-dependence of thrombin effects on cyclic AMP formation, CCL39 cells were incubated for 5 min with increasing concentrations of α -thrombin, upon stimulation of adenylate cyclase with PGE₁, cholera toxin or forskolin (Fig. 2). PGE₁ and forskolin, which caused an immediate activation, were added together with thrombin, whereas cholera toxin, acting more slowly, was added 30 min before thrombin and IBMX. Thrombin effects were very similar in the three cases, indicating that these effects are not restricted to receptor-mediated activation of adenylate cyclase. The dose-dependence curves were clearly biphasic, with a maximal inhibition around 0.1 nM-thrombin and a progressive relief of the inhibition above this concentration. The highest concentration of thrombin tested (10 nM) did not cause any inhibition of cyclic AMP production, and even slightly potentiated the accumulation induced by cholera toxin and forskolin.

The inhibitory effect of thrombin is mimicked by AlF₄⁻ and abolished by pertussis toxin

We previously reported that AlF₄⁻ causes a strong inhibition of PGE₁-stimulated adenylate cyclase in intact CCL39 cells [14], presumably by activating an inhibitory G-protein (G_i). A similar inhibition (by 50%) was elicited by NaF and AlCl₃ in cholera-toxin-stimulated cells (Fig. 3a). The effect of NaF in the presence of 10 μM-AlCl₃ was dose-dependent, with a maximal inhibition of adenylate cyclase above 2 mM, a concentration range in which the major complex ion formed by Al³⁺ and F⁻ is expected to be AlF₄⁻[23]. Interestingly, AlF₄⁻-induced inhibition was completely abolished in cells pretreated with pertussis toxin (Fig. 3a).

If the inhibition exerted by low thrombin concentrations on cyclic AMP production is due, as with AlF₄⁻, to the dissociation of a G_i protein, the relief of inhibition observed at high thrombin concentrations might be caused by a desensitization of thrombin receptors, leading to an attenuation of the coupling between receptors and G_i proteins. If this were the case, addition of NaF and AlCl₃ in order to activate the G_i protein directly without involving thrombin receptors should restore the inhibition of cyclic AMP formation at high thrombin concentrations. Fig. 3(b) shows that this is not true. In fact, at concentrations above 0.03 nM, thrombin was able to suppress progressively the inhibition induced by AlF₄⁻. This result definitely rules out the hypothesis of a dampened coupling between thrombin receptors and G_i proteins. It rather suggests that thrombin can either prevent the dissociation of G_i or overcome the G_i-mediated inhibition by an enhanced activation of adenylate cyclase.

We therefore examined the effects of thrombin on cyclic AMP production in pertussis-toxin-treated cells, in which G_i dissociation should be severely impaired. Fig. 4 shows that in these cells the inhibitory phase of the concentration-dependence curve of thrombin effects on cyclic AMP has completely disappeared. In contrast, the second phase was not affected by the pertussis-toxin treatment, and this resulted, at the highest thrombin

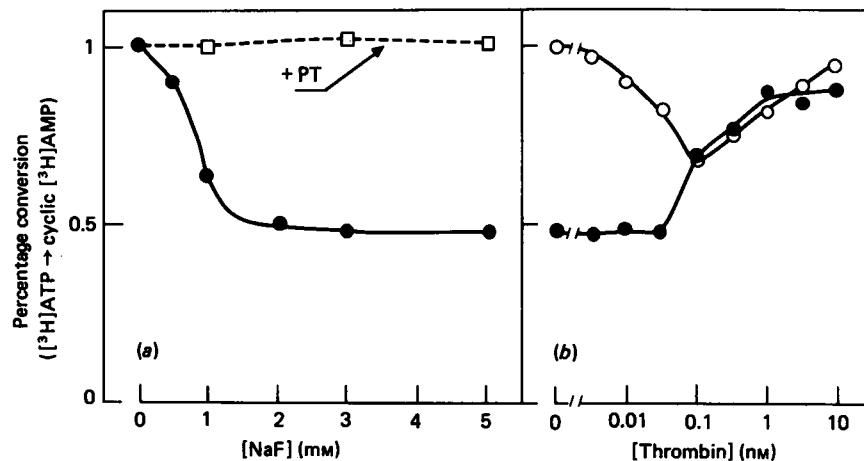

Fig. 3. Inhibition of cholera-toxin-stimulated cyclic AMP formation by AlF_4^- ; effect of thrombin in the presence of AlF_4^-

^3H Adenine-labelled cells were pretreated for 30 min with 100 ng of cholera toxin/ml. (a) Cells were incubated with $10 \mu\text{M}$ - AlCl_3 and various concentrations of NaF, in the presence of 1 mM-IBMX. Formation of cyclic AMP was determined after 5 min. Some cultures (□) were pretreated for 5 h with 10 ng of pertussis toxin (PT)/ml added directly to the labelling medium. (b) Thrombin was added at the indicated concentrations to cholera-toxin-pretreated cells without (○) or with (●) 5 mM-NaF and $10 \mu\text{M}$ - AlCl_3 , in the presence of 1 mM-IBMX, for 5 min.

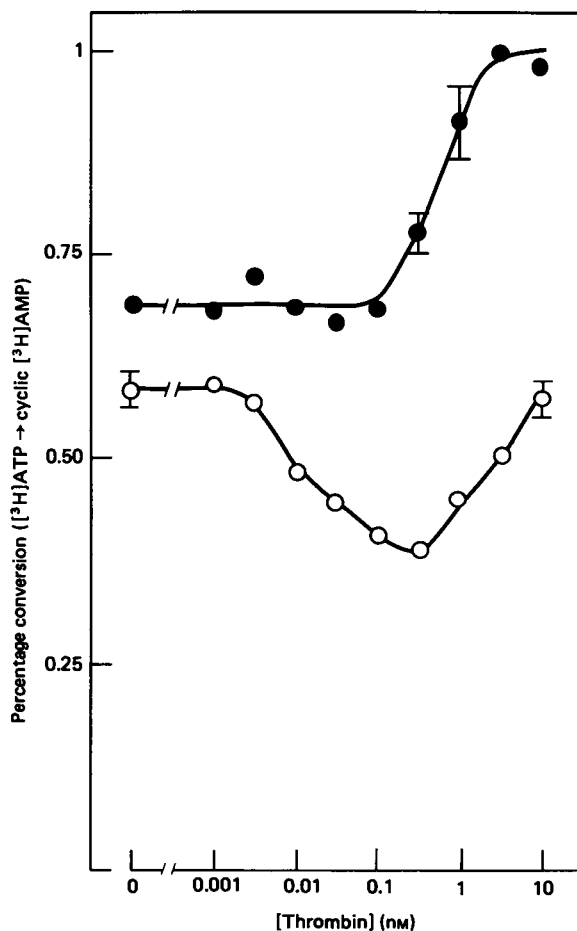

Fig. 4. Effect of pertussis toxin on thrombin inhibition of cholera-toxin-stimulated cyclic AMP accumulation

^3H Adenine-labelled cells were incubated for 5 h without (○) or with (●) 10 ng of pertussis toxin (PT)/ml, before treatment with cholera toxin (100 ng/ml) for 30 min. Then IBMX (1 mM) and various concentrations of thrombin were added for 3 min before determination of cyclic AMP formation.

concentrations, in a striking potentiation of the cholera-toxin-induced activation. Thus it clearly appears that, at concentrations above 0.1 nM, thrombin can enhance the cholera-toxin-induced activation of adenylate cyclase under conditions where G_i dissociation is strongly inhibited. It is noteworthy that, in pertussis-toxin-treated cells, the activation of cyclase in response to cholera toxin, in the absence of thrombin, was usually slightly higher than in control cells (as in the experiment represented in Fig. 4). This suggests that in control cells G_i exerts a basal tonic inhibition on the cyclase.

The stimulatory effect of thrombin is mimicked by phorbol esters and abolished by down-regulation of protein kinase C

As thrombin is a potent activator of the phosphoinositide-specific phospholipase C in CCL39 cells [6], and hence presumably activates protein kinase C, we examined the effects of the phorbol ester PBT_2 on cyclic AMP production, to determine whether protein kinase C plays a role in the thrombin-induced modulations of adenylate cyclase activity. Fig. 5(a) shows that increasing concentrations of PBT_2 caused a progressive increase in the cholera-toxin-stimulated cyclase activity. This effect can be attributed to protein kinase C, since the inactive phorbol ester αPBT_2 had no effect even at $1 \mu\text{g}/\text{ml}$. Interestingly, activation of protein kinase C led to the complete suppression of AlF_4^- -induced inhibition, independently of the order of addition of PBT_2 and AlF_4^- . Similar results were obtained when these effectors were added together (Fig. 5a) and when cells were pretreated for 30 min with PBT_2 or for 5 min with AlF_4^- (results not shown). As shown in Fig. 5(b), the protein kinase C-mediated potentiation of adenylate cyclase could be detected only after stimulation with cholera toxin, at all toxin concentrations. The basal cyclase activity was not significantly affected by PBT_2 , in the absence or presence of IBMX (Fig. 5b, inset). Phorbol esters also potentiated the cyclic AMP accumulation after stimulation with forskolin, but in contrast slightly inhibited the PGE_1 -induced activation (results not shown).

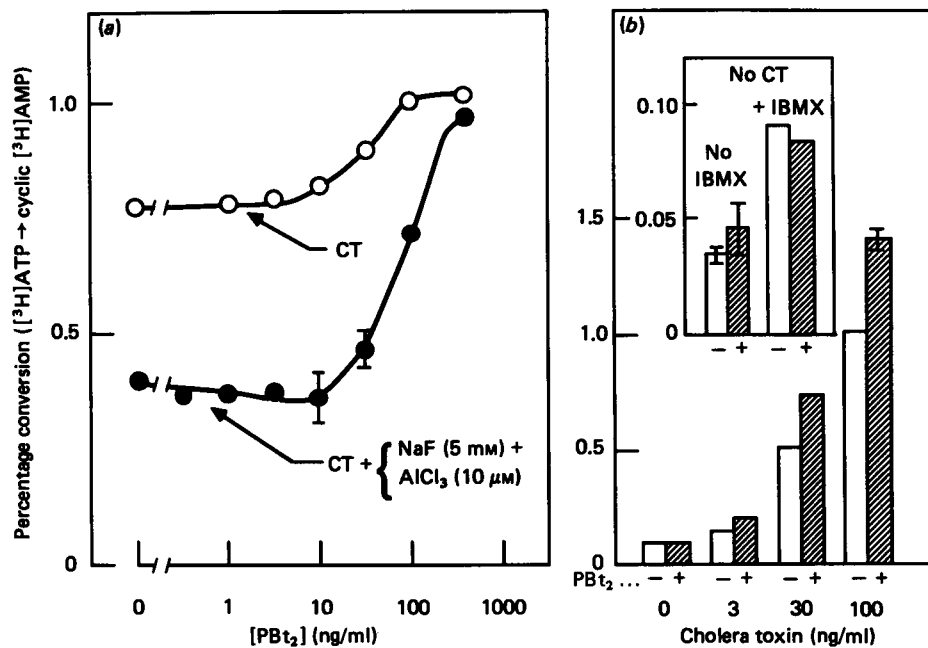

Fig. 5. Dose-dependent effects of PBT_2 on AlF_4^- inhibition of cholera-toxin-induced cyclic AMP formation

$[^3\text{H}]$ Adenine-labelled cells were pretreated for 30 min with 100 ng of cholera toxin (CT)/ml. (a) Increasing concentrations of PBT_2 were added without (○) or with (●) 5 mM-NaF and 10 μM - AlCl_3 , in the presence of 1 mM-IBMX, for 5 min. (b) Cells were treated with (▨) or without (□) 100 ng of PBT_2 /ml, along with the indicated concentrations of cholera toxin for 30 min. Then 1 mM-IBMX was added, and cyclic AMP formation was determined after 5 min. The inset presents, with an expanded scale, the effects of the PBT_2 pretreatment on cyclic AMP concentrations in the absence of cholera toxin, with or without IBMX for 5 min.

In many cell types it has been shown that protein kinase C activity can be greatly diminished by prolonged pretreatment with high concentrations of phorbol esters [24,25], owing to increased degradation of the kinase [26]. To determine whether the thrombin-induced potentiation of adenylate cyclase is indeed mediated by protein kinase C, we tested the effects of thrombin in cells pretreated for 30 h with 400 ng of PBT_2 /ml (Fig. 6). In these PBT_2 -pretreated cells the cholera toxin-stimulated adenylate cyclase, measured after thorough wash-out of PBT_2 , was no longer potentiated by phorbol esters. Moreover, the cyclase activity was slightly lower than in control cells (Fig. 6, inset). These results suggest, firstly, that protein kinase C has indeed been strongly down-regulated in PBT_2 -pretreated cells and, secondly, that there is a small constitutive kinase C-mediated enhancement of the stimulated cyclase activity in control cells. When increasing concentrations of thrombin were added to protein kinase C-depleted cells, only the inhibitory effect of thrombin was observed on the cholera-toxin-stimulated cyclase (Fig. 6). The maximal inhibition was about 50%, as with AlF_4^- (Fig. 3), and half-maximal inhibition was obtained at 0.02 nM-thrombin. The stimulatory effect of high thrombin concentrations was almost completely abolished by protein kinase C down-regulation, and both inhibitory and stimulatory effects were suppressed in kinase C-depleted cells pretreated with pertussis toxin (Fig. 6).

G_i is not the target of protein kinase C

One plausible mechanism by which protein kinase C might potentiate adenylate cyclase responses is by inactivating a G_i protein and thus relieving a tonic

inhibitory influence, as proposed for platelets [27,28] and for S49 lymphoma cells [29]. If this were the case, phorbol esters should no longer be effective after pertussis-toxin inactivation of G_i . Fig. 7 shows that in fact pertussis-toxin-treated cells maintain the ability to respond to PBT_2 with enhanced cyclic AMP production. This indicates that protein kinase C must act by modifying a pertussis-toxin-insensitive component of the adenylate cyclase complex. Comparison of the efficiency of maximal concentrations of PBT_2 and thrombin for potentiating cyclic AMP production in pertussis-toxin-treated cells (Fig. 7) indicates that the stimulatory effects of thrombin on adenylate cyclase can be entirely accounted for by protein kinase C activation.

Inhibitory effects of cyclic AMP on phosphoinositide breakdown

We have previously reported that increasing cyclic AMP in CCL39 cells results in a marked inhibition of thrombin-induced phosphoinositide hydrolysis [14], and should therefore decrease the subsequent activation of protein kinase C. Since the above-mentioned data suggested a role of protein kinase C in the effects of high thrombin concentrations on adenylate cyclase, it was decided to examine how much the stimulation of phospholipase C is affected under the conditions used in this study. Inositol phosphate accumulation was measured in the presence of 20 mM-LiCl to inhibit the inositol-1-phosphatase [30], upon stimulation with 0.01 nM- or 1 nM-thrombin. Fig. 8 shows that pretreatment of cells with 100 ng of cholera toxin/ml for 30 min resulted in only a small inhibition of phospholipase C activity at 1 nM-thrombin (by less than 15%), but in a marked

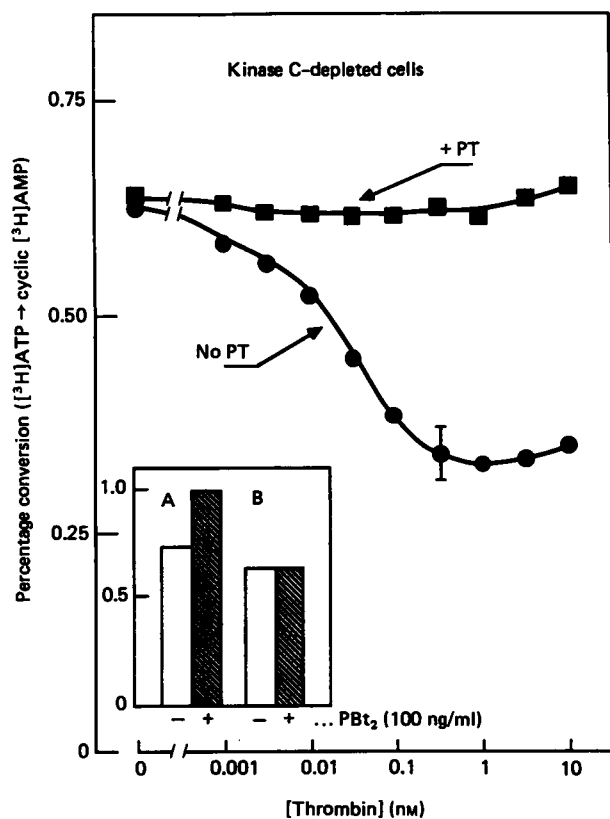

Fig. 6. Effect of a prolonged pretreatment with PBt_2 on the thrombin-induced changes in cyclic AMP formation in cholera-toxin-stimulated cells: effect of pertussis toxin in PBt_2 -pretreated cells

Cells were treated with 400 ng of PBt_2 /ml over the 30 h incubation in serum-free DMEM labelled with $[^3H]$ -adenine. Pertussis toxin (PT) was added to some dishes (■) at 10 ng/ml for the last 5 h. Then all cultures were incubated for 30 min with 100 ng of cholera toxin/ml before addition of 1 mM-IBMX and increasing concentrations of thrombin for a further 3 min. Inset: control cells (A) or cells pretreated with 400 ng of PBt_2 /ml (B) were washed extensively with DMEM before being stimulated for 30 min with 100 ng of cholera toxin/ml, in the absence (□) or presence (▣) of 100 ng of PBt_2 /ml. Cyclic AMP accumulation was then measured as described above after a 3 min incubation with 1 mM-IBMX.

decrease (by 60%) at 0.01 nM-thrombin. When IBMX was added together with thrombin, the inhibition of phospholipase C was more pronounced, reaching 30% at 1 nM-thrombin and up to 85% at 0.01 nM. It can be therefore predicted that, in the presence of cholera toxin and IBMX, the conditions most frequently used in this study to measure cyclic AMP production, protein kinase C should be almost normally activated at high thrombin concentrations, but only very weakly activated at low concentrations. Accordingly, the inhibitory effects of thrombin on adenylate cyclase should be less obscured by the kinase C-mediated activation at low thrombin concentrations under these experimental conditions, which can be expected to emphasize the biphasic shape of the dose/response curve.

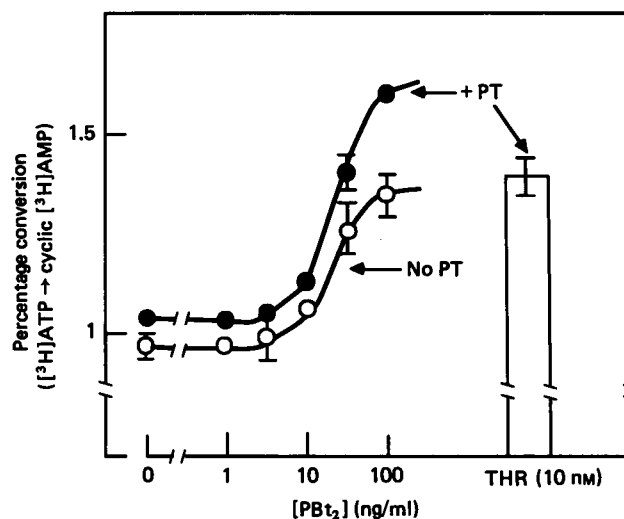

Fig. 7. Effect of pertussis toxin on PBt_2 potentiation of cholera-toxin-stimulated cyclic AMP accumulation

$[^3H]$ Adenine-labelled cells were treated (●) or not (○) with 10 ng/ml of pertussis toxin (PT) for 5 h before stimulation for 30 min with 100 ng of cholera toxin/ml in the presence of increasing concentrations of PBt_2 . Cyclic AMP formation was measured after a further 5 min incubation with 1 mM-IBMX. The bar represents the cyclic AMP in pertussis-toxin-treated cells, after stimulation with cholera toxin and exposure to 10 nM-thrombin (THR) and 1 mM-IBMX for 5 min.

DISCUSSION

Addition of α -thrombin to the hamster fibroblast line CCL39 results in the stimulation of DNA synthesis and cell division [4]. Our previous studies have indicated that phosphoinositide hydrolysis plays a crucial role in the mitogenic signalling pathway of thrombin [15,16]. The present results demonstrate that, in addition, thrombin exerts complex effects on the adenylate cyclase system. We report that a biphasic response to thrombin is observed for activation of adenylate cyclase by PGE_1 , cholera toxin or forskolin. (1) Low thrombin concentrations below 0.1 nM decrease the stimulated cyclase activity. A similar inhibition is induced by AlF_4^- , which is known to activate GDP-bound G proteins [17], presumably by mimicking the γ -phosphate of GTP [31]. Thrombin- and AlF_4^- -induced inhibitions are not additive, and both are abolished by pretreatment of cells with pertussis toxin. (2) At thrombin concentrations above 0.1 nM, adenylate cyclase inhibition is progressively suppressed. This is not due to an impaired inhibition, but rather to a compensating activation, since abolition of the inhibitory reaction by pertussis toxin results in a marked potentiation by thrombin of cholera-toxin-stimulated cyclic AMP formation. A similar enhancement of adenylate cyclase activity can be induced by an active phorbol ester in both normal and pertussis-toxin-treated cells, suggesting a role of protein kinase C. Accordingly, the stimulatory phase of the thrombin effect is suppressed after down-regulation of protein kinase C.

Altogether, these results lead us to conclude, as summarized in the model in Fig. 9, that the inhibitory

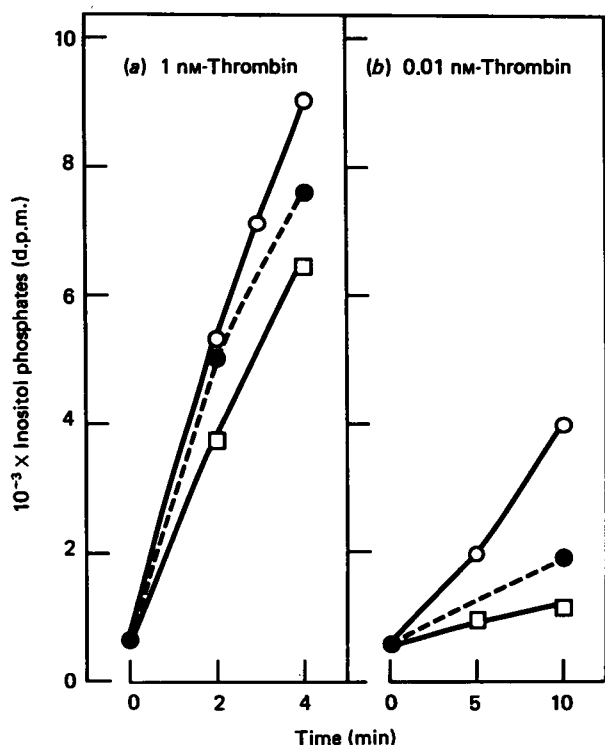

Fig. 8. Effect of cholera toxin on thrombin-induced inositol phosphate formation

[³H]Inositol-labelled cells, equilibrated in HEPES-buffered medium as indicated in the Experimental section, were incubated for 30 min without (○) or with (●, □) 100 ng of cholera toxin/ml. LiCl (20 mM) was added for the last 10 min of this incubation. At zero time cells were stimulated by 1 nM (a) or 0.01 nM (b) thrombin, in the absence (○, ●) or the presence (□) of 1 mM-IBMX. Total inositol phosphates were determined at various times.

effects of thrombin on adenylate cyclase are due to the activation of a pertussis-toxin-sensitive inhibitory G protein (G_i), and the stimulatory effects to the activation of protein kinase C.

These results raise several questions. One concerns the identity of the G_i protein(s) activated by thrombin. Recent studies have shown that in CCL39 cells pertussis toxin catalyses the ADP-ribosylation of two distinct proteins, of $M_r \sim 40000$ and 41000 respectively (B. Rouot, unpublished work), with the M_r -40000 protein being closely related to the α_{40} of neutrophils [32,33], as indicated by immunochemical evidence (P. Gierschick, unpublished work). Whether $G_{\alpha_{40}}$ and $G_{\alpha_{41}}$ have clearly distinct functions and whether they are both activated by thrombin is not known. Although $G_{\alpha_{40}}$ seems to be a more likely candidate for coupling thrombin receptor to phospholipase C (G_p function in Fig. 9), both $G_{\alpha_{40}}$ and $G_{\alpha_{41}}$ should be able to fulfil the G_i function by releasing their $\beta\gamma$ subunits. Indeed, the various G proteins appear to differ in their α subunit, but to share identical $\beta\gamma$ subunits [17,34], and it has been proposed that inhibition of adenylate cyclase is caused by the release of $\beta\gamma$ subunits, acting either by a mass-action effect on G_s [17] or directly on adenylate cyclase [35]. Interestingly, the treatment with pertussis toxin appears to block completely the inhibition of adenylate cyclase by all thrombin concentrations (Fig. 6), whereas it does not block the protein kinase C-mediated stimulatory effects of high thrombin concentrations, in agreement with our previous observation that thrombin-induced stimulation of phosphoinositide hydrolysis is only partially inhibited by pertussis toxin [15]. This differential pertussis-toxin sensitivity of adenylate cyclase inhibition and phospholipase C activation rather supports the hypothesis that the two pathways involve two different G-proteins.

Whatever the nature of the G protein(s) responsible for adenylate cyclase inhibition in CCL39 cells, it is

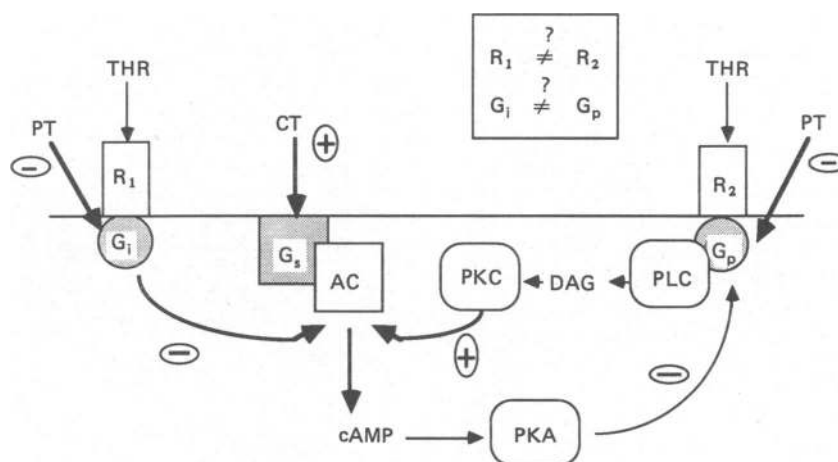

Fig. 9. Hypothetical model for thrombin-induced effects on adenylate cyclase in CCL39 cells

Thrombin (THR) receptor(s) (R_1 , R_2 ; maybe identical) are coupled to one or two pertussis-toxin-sensitive G protein(s) with two functions: inhibition of adenylate cyclase (G_i) and activation of phospholipase C (G_p). Formation of diacylglycerol (DAG) leads to activation of protein kinase C (PKC), resulting in a potentiation of stimulated cyclic AMP formation. Increased cyclic AMP causes, presumably through activation of protein kinase A (PKA), an inhibition of phospholipase C (PLC) activity. Other abbreviations: AC, adenylate cyclase; G_s , stimulatory G protein; CT, cholera toxin; PT, pertussis toxin.

notable that its (their) activation by AlF_4^- is inhibited by pertussis toxin, as is the activation by AlF_4^- of phospholipase C [14]. This observation is not consistent with the commonly accepted idea that covalent modification of G proteins by pertussis toxin essentially inhibits their coupling with receptors [36] without affecting their direct activation by GTP analogues [35] or by fluoride [37]. Our data rather support the model proposed by Jakobs *et al.* [38] of an impaired dissociation of ADP-ribosylated G proteins.

Another as yet unresolved question is whether inhibition of adenylate cyclase and stimulation of phospholipase C by thrombin in CCL39 cells involve two different receptors or a single one. Previous studies of thrombin binding to CCL39 cells have revealed a major high-affinity binding site of $M_r \sim 150000$, but the role of this receptor in mitogenicity has not been firmly established [39]. In another strain of hamster fibroblasts a single thrombin receptor has been proposed to mediate the effects on phospholipase C and on adenylate cyclase [7], whereas two distinct receptors are thought to be involved in platelets [19].

What may be the target of protein kinase C in the adenylate cyclase system of CCL39 cells? It is known that protein kinase C can either inhibit or potentiate the accumulation of cyclic AMP promoted by adenylate cyclase activators in various cell types (see ref. [11] for review). The potentiating effects have been related either to an impairment of G_i -induced inhibition caused by phosphorylation of the α_i subunit [27–29] or to an enhancement of the interaction of α_s with the catalytic unit of adenylate cyclase [40]. Our data in CCL39 cells are consistent with the latter interpretation. Indeed, activation of protein kinase C results in increased cyclic AMP accumulation in response to cholera toxin or forskolin, and this effect is not primarily related to G_i , since it is not suppressed by pertussis-toxin treatment, in contrast with results obtained in Swiss 3T3 cells [41]. The enhancing effects of phorbol esters and pertussis toxin are in fact additive in CCL39 cells (Fig. 7), in contrast with the findings by Bell & Brunton [29] on S49 lymphoma cells. Interestingly, however, activation of G_i by AlF_4^- is completely overcome by high concentrations of phorbol esters, suggesting that the kinase C-mediated modification of the cyclase system makes it refractory to free $\beta\gamma$ subunits. The target of protein kinase C might be α_s or the cyclase itself, which is consistent with the recent report that protein kinase C activation induces the phosphorylation both *in vitro* and *in vivo* of the catalytic subunit of adenylate cyclase [42]. In contrast with their enhancing effects on cholera toxin and forskolin, phorbol esters cause in CCL39 cells a small inhibition of PGE_1 -stimulated adenylate cyclase, which suggests a more complex regulation of receptor-mediated stimulations, presumably owing to additional kinase C-mediated modifications at the level of receptors. A similar inhibition of PGE_1 -stimulated cyclic AMP accumulation has been observed in platelets [43] and in S49 lymphoma cells [44].

Interactions between phospholipase C and adenylate cyclase systems are even more complex, since increased cyclic AMP inhibits the phospholipase C pathway in CCL39 cells. The mechanism of this inhibition is not yet known, but the inhibitory effects of cyclic AMP on AlF_4^- -induced activation of phospholipase C [14] indicate that a post-receptor target is involved, rather than

thrombin receptors as in platelets [45]. Interestingly, the inhibitory effect of cyclic AMP on phospholipase C activation is more pronounced at low thrombin concentrations, which explains why the G_i -mediated inhibition of adenylate cyclase has been found to be dominant on the protein kinase C-mediated activation at low thrombin concentrations. The same is true for AlF_4^- , since this ion is a weak activator of phospholipase C [14].

It should be emphasized that throughout this study we have stimulated adenylate cyclase to gain an insight into the effects of thrombin on cellular cyclic AMP. Variations of basal cyclic AMP concentrations in thrombin-stimulated cells are very small, but preliminary results obtained with a more sensitive method indicate that the present results can be roughly extrapolated to unstimulated cyclase. A small decrease in cellular cyclic AMP is indeed observed in CCL39 cells upon stimulation with thrombin, especially at low thrombin concentrations. As re-initiation of DNA synthesis in CCL39 cells is strongly inhibited by increased cyclic AMP, a decrease in cyclic AMP, even of small amplitude, may be of great importance for the mitogenic response. This hypothesis requires testing.

We are grateful to K. Seuwen for critical reading of the manuscript and to M. Bonacci for skilful secretarial work. This work was supported by grants from Glaxo (France), the Centre National de la Recherche Scientifique (LP 7300), la Fondation pour la Recherche Médicale and the Association pour la Recherche contre le Cancer.

REFERENCES

1. Chen, L. B. & Buchanan, J. M. (1975) *Proc. Natl. Acad. Sci. U.S.A.* **72**, 131–135
2. Carney, D. H., Glenn, K. C. & Cunningham, D. D. (1978) *J. Cell. Physiol.* **95**, 13–22
3. Pohjanpelto, P. (1978) *J. Cell. Physiol.* **95**, 189–194
4. Van Obberghen-Schilling, E., Pérez-Rodríguez, R., Franchi, A., Chambard, J. C. & Pouysségur, J. (1983) *J. Cell. Physiol.* **115**, 123–130
5. Carney, D. H., Scott, D. L., Gordon, E. A. & La Belle, E. F. (1985) *Cell* **42**, 479–488
6. L'Allemain, G., Paris, S., Magnaldo, I. & Pouysségur, J. (1986) *J. Cell. Physiol.* **129**, 167–174
7. Raben, D. M., Yasuda, K. & Cunningham, D. D. (1987) *Biochemistry* **26**, 2759–2765
8. Murayama, T. & Ui, M. (1987) *J. Biol. Chem.* **262**, 5522–5529
9. Berridge, M. J. & Irvine, R. F. (1984) *Nature (London)* **312**, 315–321
10. Majerus, P. W., Wilson, D. B., Connolly, T. M., Bross, T. E. & Neufeld, E. J. (1985) *Trends Biochem. Sci.* **10**, 168–171
11. Kikkawa, U. & Nishizuka, Y. (1986) *Annu. Rev. Cell Biol.* **2**, 149–178
12. Magnaldo, I., Talwar, H., Anderson, W. B. & Pouysségur, J. (1987) *FEBS Lett.* **210**, 6–10
13. Rebecchi, M. J. & Rosen, O. M. (1987) *Biochem. J.* **245**, 49–57
14. Paris, S. & Pouysségur, J. (1987) *J. Biol. Chem.* **262**, 1970–1976
15. Paris, S. & Pouysségur, J. (1986) *EMBO J.* **5**, 55–60
16. Chambard, J. C., Paris, S., L'Allemain, G. & Pouysségur, J. (1987) *Nature (London)* **326**, 800–803
17. Gilman, A. G. (1987) *Annu. Rev. Biochem.* **56**, 615–649

18. Aktories, K. & Jakobs, K. H. (1984) *Eur. J. Biochem.* **145**, 333–338
19. McGowan, E. B. & Detwiler, T. C. (1986) *J. Biol. Chem.* **261**, 739–746
20. Brass, L. F., Laposata, M., Banga, H. S. & Rittenhouse, S. E. (1986) *J. Biol. Chem.* **261**, 16838–16847
21. Bone, E. A., Fretten, P., Palmer, S., Kirk, C. J. & Michell, R. H. (1984) *Biochem. J.* **221**, 803–811
22. Bozou, J. C., Amar, S., Vincent, J. P. & Kitabgi, P. (1986) *Mol. Pharmacol.* **29**, 489–496
23. Goldstein, G. (1964) *Anal. Chem.* **36**, 243–244
24. Rodriguez-Pena, A. & Rozengurt, E. (1984) *Biochem. Biophys. Res. Commun.* **120**, 1053–1059
25. Ballester, R. & Rosen, O. M. (1985) *J. Biol. Chem.* **260**, 15194–15199
26. Young, S., Parker, P. J., Ullrich, A. & Stabel, S. (1987) *Biochem. J.* **244**, 775–779
27. Jakobs, K. H., Bauer, S. & Watanabe, Y. (1985) *Eur. J. Biochem.* **151**, 425–430
28. Katada, T., Gilman, A. G., Watanabe, Y., Bauer, S. & Jakobs, K. H. (1985) *Eur. J. Biochem.* **151**, 431–437
29. Bell, J. D. & Brunton, L. L. (1986) *J. Biol. Chem.* **261**, 12036–12041
30. Hallcher, L. M. & Sherman, W. R. (1980) *J. Biol. Chem.* **255**, 10896–10901
31. Bigay, J., Deterre, P., Pfister, C. & Chabre, M. (1985) *FEBS Lett.* **191**, 181–185
32. Gierschik, P., Falloon, J., Milligan, G., Pines, M., Gallin, J. I. & Spiegel, A. (1986) *J. Biol. Chem.* **261**, 8058–8062
33. Oinuma, M., Kataka, T. & Ui, M. (1987) *J. Biol. Chem.* **262**, 8347–8353
34. Spiegel, A. M. (1987) *Mol. Cell. Endocrinol.* **49**, 1–16
35. Katada, T., Oinuma, M. & Ui, M. (1986) *J. Biol. Chem.* **261**, 5215–5221
36. Masters, S. B., Stroud, R. M. & Bourne, H. R. (1986) *Protein Eng.* **1**, 47–54
37. Katada, T., Oinuma, M., Kusakabe, K. & Ui, M. (1987) *FEBS Lett.* **213**, 353–358
38. Jakobs, K. H., Aktories, K. & Schultz, G. (1984) *Eur. J. Biochem.* **140**, 177–181
39. Van Obberghen-Schilling, E. & Pouyssegur, J. (1985) *Biochim. Biophys. Acta* **847**, 335–343
40. Bell, J. D., Buxton, I. L. O. & Brunton, L. L. (1985) *J. Biol. Chem.* **260**, 2625–2628
41. Rozengurt, E., Murray, M., Zachary, I. & Collins, M. (1987) *Proc. Natl. Acad. Sci. U.S.A.* **84**, 2282–2286
42. Yoshimasa, T., Sibley, D. R., Bouvier, M., Lefkowitz, R. J. & Caron, M. G. (1987) *Nature (London)* **327**, 67–70
43. Williams, K. A., Murphy, W. & Haslam, R. J. (1987) *Biochem. J.* **243**, 667–678
44. Bell, J. D. & Brunton, L. L. (1987) *Am. J. Physiol.* **252**, E783–E789
45. Lerea, K. M. & Glomset, J. A. (1987) *Proc. Natl. Acad. Sci. U.S.A.* **84**, 5620–5624

Received 29 February 1987/10 March 1988; accepted 18 April 1988