

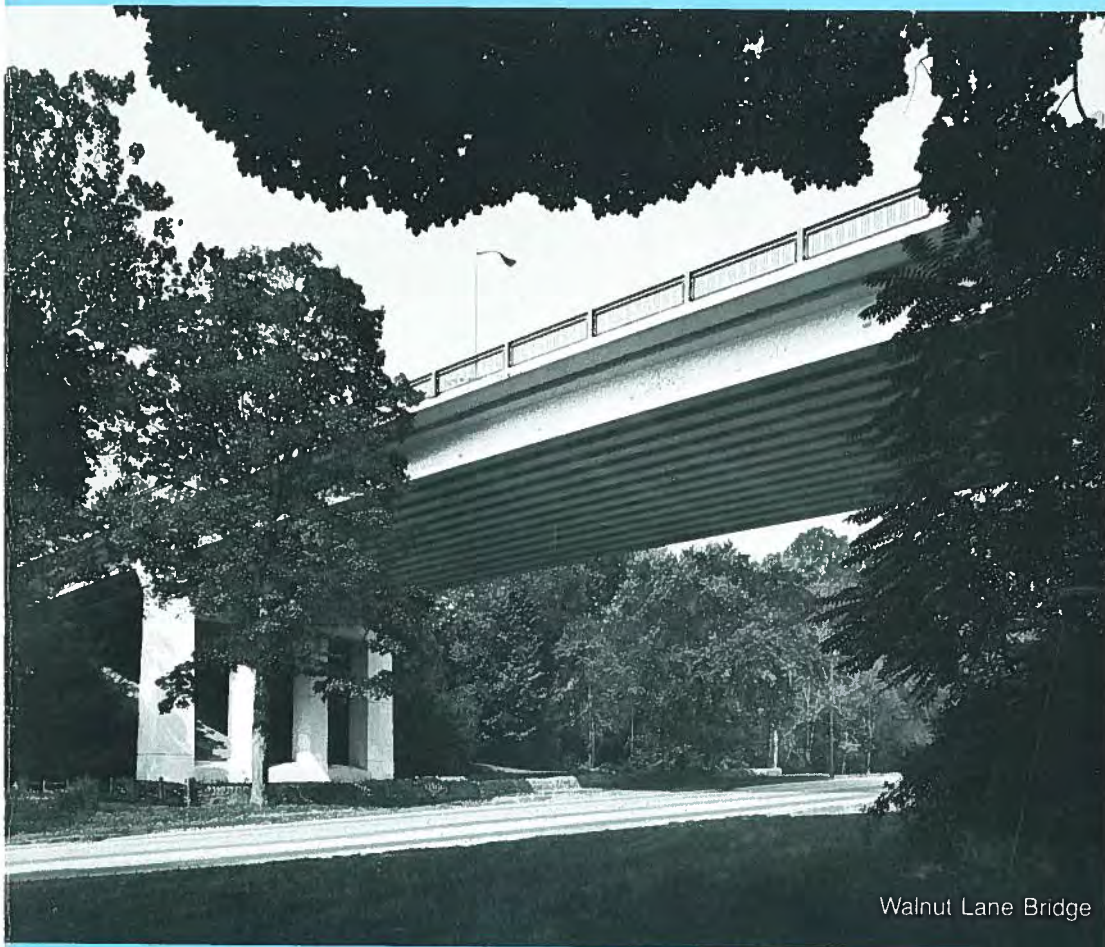

Reflections on the Beginnings of Prestressed Concrete in America



Walnut Lane Bridge

- Magnel's Impact on the Advent of Prestressed Concrete
- Dynamic American Engineers Sustain Magnel's Momentum
- The Innovators of Prestressed Concrete in Florida
- Prestressed Concrete Innovations in Tennessee
- Prestressed Concrete Developments in the Western United States
- Early History of Prestressed Concrete in Colorado
- An Adventure in Prestressed Concrete
- The Beginnings of Prestressed Concrete in Canada
- The End of the "Beginnings"

The Prestressed Concrete Institute
is not responsible for the statements
and opinions expressed in this publication.

Copyright© 1981 by
Prestressed Concrete Institute
201 N. Wells Street
Chicago, Illinois 60606

Reprinted from the copyrighted
JOURNAL of the Prestressed Concrete Institute,
Vol. 23, No. 3 May/June 1978 and
successive issues through Vol. 25, No. 3
May/June 1980.

All rights reserved. No part of this
publication may be reproduced in any
form or by any means, without the
prior written permission of the
Prestressed Concrete Institute.

Printed in the United States of America

ISBN Number: 0-937040-18-5

* * * * *

Editor-in-Chief: George D. Nasser
Assistant Editor: Deborah J. LeBrun



Nineteen seventy-nine was the 25-year Silver Jubilee of the founding of the Prestressed Concrete Institute.

To commemorate this anniversary, the PCI JOURNAL presented a series of papers on the early history of prestressed and precast concrete in North America, narrated by the individuals who participated in the early development of the industry. These papers were published in 13 successive issues of the JOURNAL from May-June 1978 through May-June 1980.

Because of the heavy demand for these papers it was decided to compile the series into a single volume. Part 1, on the design and construction of Walnut Lane Bridge, describes the significant role Professor Magnel of Belgium played in introducing prestressed concrete to America. Part 2 covers major early contributions of American engineers. Parts 3 through 8 describes the early history of prestressed concrete construction in Florida, Tennessee, the middle and southwestern United States, Colorado, the Northwestern states, and Canada. The concluding section (Part 9) recounts further details about the pioneers and related developments of the early prestressing industry on the east and west regions of America. A concluding section summarizes the industry's landmark events.

This volume contains not only valuable practical information on prestressed concrete, but serves as a unique historical record of one of the most exciting periods in the annals of construction.

CONTENTS

Introduction	1	Part 6—Early History of Prestressed Concrete in Colorado	163
<i>Charles C. Zollman</i>		<i>George C. Hanson</i>	
Part 1—Magnel's Impact on the Advent of Prestressed Concrete	5	Part 7—An Adventure in Prestressed Concrete	189
<i>Charles C. Zollman</i>		<i>Arthur R. Anderson</i>	
Part 2—Dynamic American Engineers Sustain Magnel's Momentum	33	Part 7 (cont.)—An Adventure in Prestressed Concrete	238
<i>Charles C. Zollman</i>		<i>Arthur R. Anderson</i>	
The Bill Dean We Knew	72	Part 8—The Beginnings of Prestressed Concrete in Canada	257
<i>McLeod C. Nigels</i>		<i>Mark W. Huggins</i>	
Part 3—The Innovators of Prestressed Concrete in Florida	77	Part 9—The End of the "Beginnings"	285
<i>Harry Edwards</i>		<i>Charles C. Zollman</i>	
Part 3 (cont.)—The Innovators of Prestressed Concrete in Florida	104	Part 9 (cont.)—The End of the "Beginnings"	308
<i>Harry Edwards</i>		<i>Charles C. Zollman</i>	
Part 4—Prestressed Concrete Innovations in Tennessee	121	Part 9 (cont.)—The End of the "Beginnings"	332
<i>Ross H. Bryan</i>		<i>Charles C. Zollman</i>	
Part 5—Prestressed Concrete Developments in the Western United States	141	Milestones of Events and Developments in North American Prestressed Concrete Industry (1939-1958)	361
<i>Tadius J. Gutt</i>			
		Walnut Lane Bridge Named "Outstanding Achievement"	366



Part 1—
Magnel's Impact
on the Advent of
Prestressed Concrete

by
Charles C. Zollman

Magnel's Impact on the Advent of Prestressed Concrete



Charles C. Zollman
Consulting Engineer
Newtown Square, Pennsylvania

*Whatsoever a man soweth,
that shall he also reap
(Galatians 6:7)*

No single event was more instrumental in launching the prestressed and precast concrete industry in North America than the construction of the Walnut Lane Bridge in Philadelphia in 1950 (see articles in Sept.-Oct. 1976 PC JOURNAL¹).*

More than anything else, however, it was the charisma, dynamism, and engineering talent displayed by the man who designed the Walnut Lane Bridge, namely Professor Gustave Magnel of Belgium, that gave the impetus neces-

sary for the acceptance and development of prestressed concrete in the United States.

On the other hand, very few know *how* this came about, *how* the Belgian-American Educational Foundation, an American-sponsored organization founded in 1920 as an aftermath of World War I, was to be instrumental in bringing Professor Magnel to the United States in 1946. Nor is it known how many apparently unconnected events and coincidences which took place during that period, led to the construction of the Walnut Lane Bridge.

This is an extraordinary and fascinating story which I believe should be recorded for posterity.

*It should be mentioned that the principles of prestressing had been known and applied to circular tanks much earlier in North America.

The author traces the events that led to the construction of the Walnut Lane Bridge—the first major linear prestressed concrete structure in the United States. In particular, he emphasizes the significant role that Professor Gustave Magnel played in introducing prestressed concrete to North America.

Belgian-American Educational Foundation

America's compassion for the downtrodden and its generosity towards them is legendary. During World War I, it was exemplified by the activities of the "Commission for Relief in Belgium" chaired by Herbert Hoover, who later became the 31st President of the United States.

At the end of World War I, the Commission was left with a substantial surplus of funds. Herbert Hoover, who had become fond of the Belgians, was convinced it was in the best interests of Belgium and the United States, to continue this assistance, though in another form. He then founded the "Belgian-American Educational Foundation" to be funded from the "Belgium Relief" surplus. The Foundation's purpose was to select about 15 to 20 of the most promising graduates in any field or discipline from the four Belgian-Government sponsored Universities: Ghent, Brussels, Louvain and Liege.

Each year, beginning in 1920, graduates in law, medicine, engineering, the sciences, music, business administration, and in many other disciplines were invited for a 1-year stay in the United States. They were encouraged to pursue an education at an American

university of their choice. No strings were attached to this invitation* although it was understood that at the end of their studies they would return to Belgium with the expertise and singular "know-how" acquired in the United States.

At the time, Herbert Hoover did not realize the extent of the impact the Foundation would have on American-Belgian political and economical relations. To some degree, this relationship would affect the outcome of World War II and the introduction of prestressed concrete to the United States. Thus, until 1940 when the Germans invaded Belgium, temporarily halting the Foundation's activities, Belgian graduates annually came to the United States. Most of them acquired advanced degrees, usually doctoral degrees.

By 1940, many of the Foundation's alumni had become leaders in Belgium's industry, business and government. Some were instrumental in developing business with the United States, others became influential in Belgian politics, or other national and international bodies. For example, Armand Cerulus, a student of Harvard's extraordinary Professor

*For the record, the Foundation's original name during the Hoover Administration was "C.R.B. Educational Foundation." Essentially, the Foundation's policy arranged for the exchange of students between Belgium and America; American graduates also attended Belgian universities in a 1-year annual exchange.

The Author

Charles C. Zollman was instrumental in the promotion, development, design and construction of Philadelphia's Walnut Lane Bridge, the first major prestressed concrete bridge in North America. He was the first chairman of PCI's Technical Activities Committee from 1957 to 1960 and an active participant in PCI affairs as director from 1956 to 1959.

Mr. Zollman's early consulting services for the design and construction of pretensioning plants throughout the United States, his activities in the field of precast concrete as well as his many contributions to the PCI, have identified him as a pioneer of this industry in North America.

Mr. Zollman was a student of Professor Gustave Magnel at Ghent University, Belgium. Later, he became Magnel's unofficial representative in the United States, responsible for the detailed arrangements of Magnel's several trips to this continent.

In 1973, the Delaware County Chapter of the Pennsylvania Society of Professional Engineers named Mr. Zollman "Engineer of the Year." The honor was bestowed for his "Engineering Excellence in the design and administration of numerous large civil engineering projects; for his pioneering achievements in the design of prestressed concrete bridges and for his dedication as a teacher of the theory of prestressed concrete design."

Filmore Swain, later became full Professor of Architecture at Ghent University. Léon Rucquoi eventually became the Technical Consultant in New York for the Steelmakers and the Metal Working Industries of Belgium and Luxembourg. Fernand Chenu was made head of the Electrorail empire which merged with Westinghouse after World War II. Daniel Vandepitte, who designed and supervised the construction of Belgium's first suspension bridge using prestressed concrete stiffening girders, was later appointed Professor and Rector (President) of Ghent University. There were many others.

During World War II, when available minerals such as nickel, cobalt, tin, zinc and radium were unavailable to the Western Allies, some of the Foundation alumni (who had escaped to England) helped America obtain these scarce materials from the Belgian Congo (today known as Zaire). The shoe was on the other foot and this time the Belgians were on the giving end.

This explains why Belgium was the only country in the world not financially obligated to the U.S. after World War II. The U.S. owed the Belgian Government substantial amounts of money for goods received during the war years. This unusual situation was one factor which enabled Belgians to rapidly get re-established. Belgium's speedy recovery and the hard work of the Belgians helped make Brussels (Belgium's capital) the first European Market capital. Belgium also became headquarters for NATO.

As the years went by, other international organizations, American businesses and industrial enterprises selected Belgium as their headquarters. Unobtrusively, the Foundation did its share in furthering Belgium's interests.

Since all of the Foundation's activities were halted by World War II, funds had accumulated. These surplus funds made it possible to extend the Foundation's exchange, after the war, to represen-

tatives of Belgian business, enterprise and industry. They were invited by the Foundation to spend 1 to 3 months studying American technology which had developed substantially during the war years.

Magnel's Influence

Gustave Magnel, Professor of Engineering at the University of Ghent, was chosen to represent the entire Belgian construction industry as well as Belgium's educational and technical professions. From April to June 1946, Magnel toured the United States as "Belgian American Educational Foundation (BAEF) Scientist" and as a "member of the Belgian Scientific Mission to the United States."

Teacher Par Excellence

As early as the late twenties, Magnel's eminence as a teacher was known worldwide. The student body at the University of Ghent was a miniature "United Nations." Students flocked to Ghent to attend his structural engineering and reinforced concrete classes. His ability to present in clear and simple language the most complex theories and problems was unique and unparalleled.

Magnel was fluent in English, French and Flemish. He taught in the latter two languages with equal facility, without a trace of an accent. Students would never cut his 90-minute classes. On the contrary, they would attend classes in both languages, even though some students may have been fluent in only one language.

I remember, after nearly 40 years, my first class with Magnel. As the mild-mannered, soft spoken man walked into the room, all would stand in deference, respect, even awe. He'd gesture for us to sit down, then he'd put on his "pince-nez," look us over quietly, a grin would appear . . . and then he'd begin:

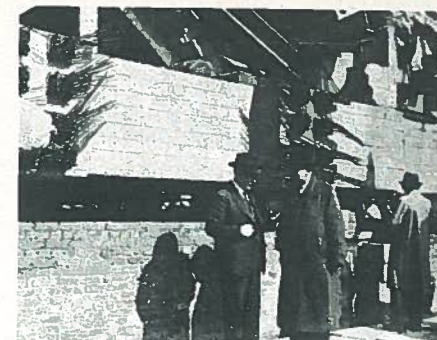

Fig. 1. Professor Gustave Magnel (left) at job-site inspecting underpinning of tower.

"Gentlemen, you have now been with this University for 2 years. You must, by now, be excellent mathematicians. But do not expect me to fill this large blackboard with all kinds of complicated formulas and their derivations. It is true that I would look like a very learned man—but that is not why I am here. I must make engineers out of you—in less than 2 years—so that you can design and analyze structures rapidly and as accurately as possible—not mathematicians who will need 6 months to solve a problem based on assumptions . . . which are inaccurate anyway. By that time the building would have been constructed by someone else."

Magnel essentially was practical as a result of his great wealth of experience (Fig. 1). Always methodical, efficient, and down to earth, he also brought a rare degree of human sympathy and insight to his relationships with his students. And they in turn revered him.

Patriot Par Excellence

It is no wonder that the Germans upon occupying Ghent in 1940 immediately removed Magnel from the University to eliminate his influence. They still allowed him to remain as Director of the Reinforced Concrete Laboratory (now bearing his name) which he had founded in 1926. It originally was located in the basement of a former hotel and later

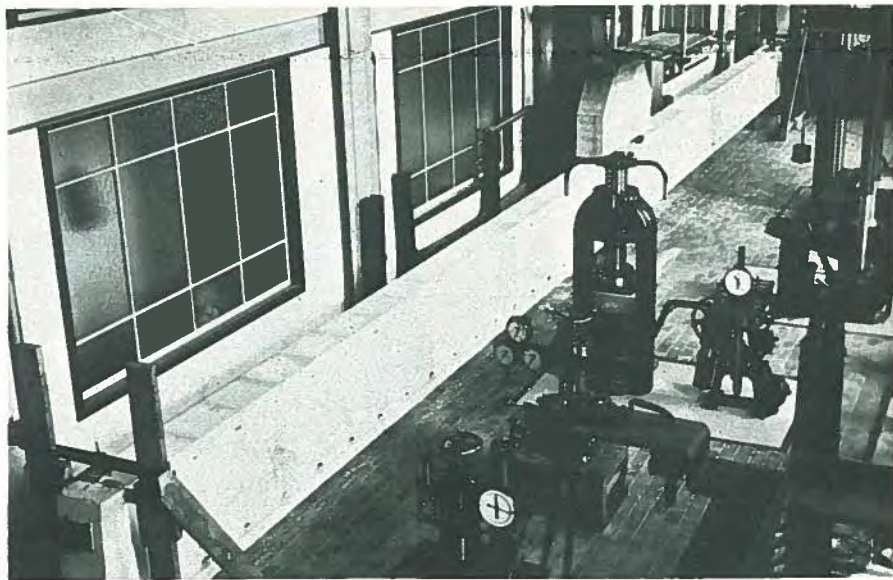

Fig. 2. Magnel's Reinforced Concrete Laboratory tested only full-scale concrete members. Magnel had little use for small-scale models. Shown here is the testing of a 66 ft (20 m) block beam.

moved to expanded laboratory facilities, and modern quarters. By 1940, it had become the most advanced and sophisticated research and testing laboratory for reinforced concrete in Europe. His great pride was the office overlooking a portion of his laboratory (similar to a captain's ship-bridge) where he would observe the testing of *full-sized* concrete members. Magnel had little use for tests on small-scale models (Figs. 2 and 3).

During the German occupation, Magnel was deeply concerned for the fate awaiting his young engineering graduates. He remembered World War I when such men were sent to work in Germany for the enemy. He undertook the task of trying to keep these young men in Belgium. No doubt, because of his unusual personality, he managed to foil the Germans' plans convincing them it was to their benefit for this man-power to stay in Belgium working on a new development. That development, of course, was prestressed concrete!

It should be noted here that the Ger-

mans favored pretensioning as can be testified by its use in the construction of submarine bases along the Atlantic and North Sea coast. American research teams sent to Germany and the occupied countries immediately after World War II have assembled data on this particular German war activity.

During these secluded years at the laboratory, Magnel had the opportunity to conduct full-scale research on prestressed concrete, including investigations on the phenomena of creep of steel and shrinkage of concrete, buckling and other problems. He also developed his post-tensioning system including the anchorages later to be known as the "Belgian or Magnel-Blaton prestressing system and sandwich plate anchorages." In doing so, he managed to keep the young Belgian engineers from having to work for the Germans.

When Magnel later tested the concrete "poured" at the Atlantic Wall along the North Sea coast, the test cubes (equivalent to American test cylinders)

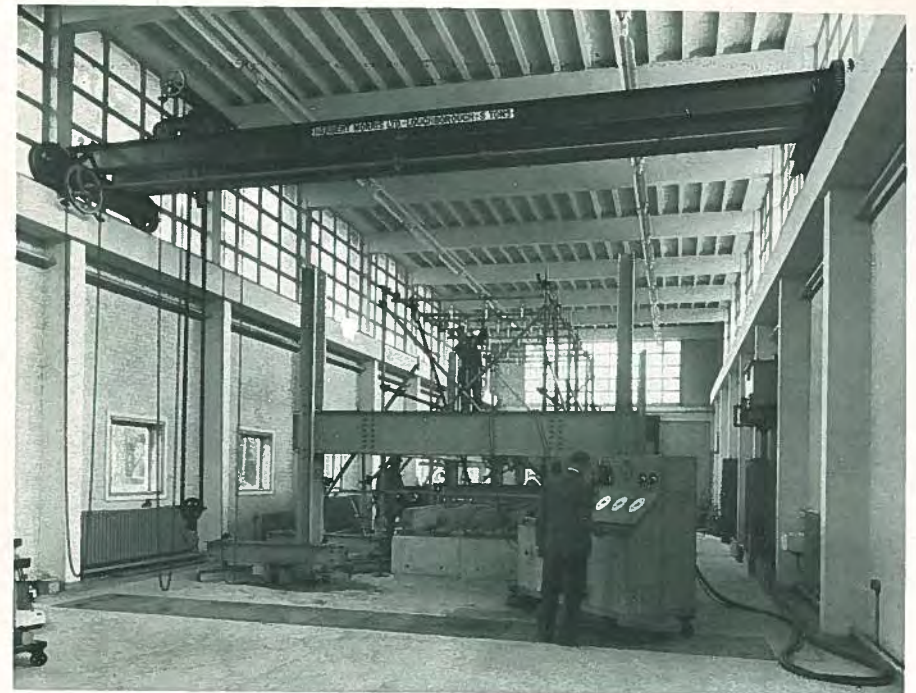

Fig. 3. General view of the interior of the structures' laboratory showing the test frame with bridge decks in position for testing. The hydraulic console is shown in the foreground.

showed, invariably, to be of low strength resulting in dire consequences for German field personnel!"

At this point, the Nazis suspected Magnel and during 1944 Gestapo orders were issued for his arrest and deportation to Germany. Luckily, Magnel was not in Ghent the day the Gestapo looked for him; his secretary had managed to hide him in Brussels. He remained a fugitive until the end of the war. He stayed constantly on the move and did not sleep in the same place more than one night. The Nazis never caught him.

With the British and Canadian Armies advancing, the Germans retreated from Belgium. Soon after, Magnel repossessed his teaching chair at the University.

There is an ironic personal note to the story of Magnel's teaching chair at the University of Ghent. His pre-war laboratory assistant was a former student

whose education had been subsidized by Magnel. During the war, this student collaborated with the Germans and temporarily seized Magnel's "chair." When Magnel rightfully regained his seat, the former assistant fled Belgium and was never heard from again.

As far as Magnel was involved, the ultimate blow to the Germans' military strength came when Brigadier Jean Paul Carriere† of the Canadian Army requested Magnel's assistance. A canal crossing in Ghent was urgently needed to carry fuel lines. With an enigmatic smile, Magnel promised to construct the

†Legend has it that he deceived the Germans in many other ways, but Magnel in his modesty rarely talked about it. For example, the story goes that some of his sophisticated, in-house designed testing instruments with their many dials, were in reality radio transmitters to London!

†Brigadier Jean Paul Carriere was later to become President of Franki Canada Ltd.

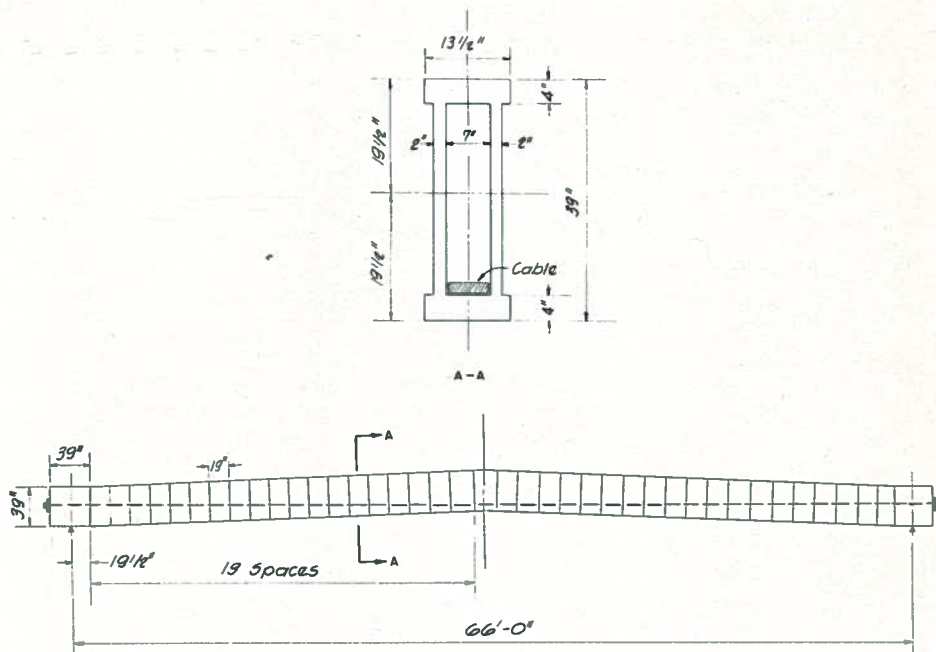

Fig. 4. Block beam used by Canadian Royal Engineers to carry British fuel lines at Ghent crossing, Terneuzen Canal, in 1944.

indispensable bridge in only *one day*.

He made this commitment with solid confidence. Long before he had gone into hiding, the Germans had ordered him to cast concrete blocks, at their expense, for their buildings. However, Magnel successfully delayed delivery of the blocks on one pretext or another. As he described in his book, *Prestressed Concrete*² (see Fig. 4), "... and in 1944, the Canadian Royal Engineers used similar beams for a bridge to carry pipelines over the Terneuzen Canal; in this case, the contractor had the beams in stock."

Now, he simply shipped the blocks to the site of the canal crossing, assembling, post-tensioning and erecting a bridge ready to carry the British fuel lines, with remarkable speed.

Magnel took great delight in telling this particular story; he had deceived the enemy once more where they were most

vulnerable. Brigadier Carriere and Magnel became great friends, which was an additional incentive for Magnel's several trips to this hemisphere, especially his visits to Canada.

In 1954, Magnel graciously accepted the opportunity to lecture at the Canadian Conference on Prestressed Concrete in Toronto, Ontario. He was instrumental in spearheading the dramatic beginning of prestressed concrete in Canada and the United States.

Introduction of Prestressed Concrete

Meanwhile, I had managed to escape Europe in 1941 and come to the United States where I worked on the East Coast for various consulting and contracting firms. Primarily, I worked as a

designer and detailer of reinforced concrete structures.

Between 1944 and 1945, news bulletins issued by the Belgian Consulate in New York sometimes carried items about Professor Magnel: first, that he had disappeared, then, that he had escaped from the Germans and finally, that he had been reinstated as Professor at the University of Ghent.

Learning of Magnel's safety during the summer of 1945, I wrote a congratulatory letter to him. In his handwritten reply, Professor Magnel wrote (among other things), "... and I even built and tested a 20 meter (about 66 ft) span prestressed beam,"—which he considered a great achievement in its time. Shortly afterward, Magnel announced that he would visit the United States as an "Advanced Fellow" of the Belgian-American Educational Foundation in spring 1946.

I promptly wrote a letter to Professor Magnel suggesting universities he should visit, consulting engineers to meet, and construction sites to be inspected. I also made arrangements for Magnel to lecture on prestressed concrete, a subject almost unknown in the United States at that time. Indeed, the only information on prestressed concrete published in an American textbook was almost an afterthought. Professor Clarence W. Dunham's book, *The Theory and Practice of Reinforced Concrete*³ included a chapter titled "Practical Details and Miscellaneous Data." (This book was considered the most advanced and popular treatise on concrete design available at the time.)

Magnel finally arrived in New York City in April 1946. He was greeted by his former secretary (who had saved his life during the Nazi occupation and later fled to the United States) and me. What an emotional reunion this was: the old professor and the young engineer who would be his guide in the New World. So much had happened since my graduation from the University of Ghent in 1939, the last time we met.



Fig. 5. Professor Magnel, the lecturer, on his American tour.

Everything went smoothly during Magnel's first trip to the United States. Because of his easy and outgoing manner and his willingness to listen, he was well received everywhere and accomplished what he came for, namely the study of American developments in education, engineering and construction which had grown enormously during the war years.

Invariably, Magnel would conclude a meeting by saying: "You are so kind to tell me what *you* have done, may I then tell you what *I* have done? I have developed prestressed concrete ..." and off he went! Fig. 5 shows Professor Magnel addressing one such meeting.

Ammann, the engineer who conceived, designed and who was responsible for the construction of the George

Washington bridge in New York was fascinated by Professor Magnel and discussed at great length the advantages and limitations of oil tempered wires and cold drawn wires. MacLeod, the chief engineer of Corbetta Construction Company, at first reluctantly, then enthusiastically took Magnel to the construction sites of concrete arches around New York discussing with the practical professor his construction problems and what prestressed concrete could do for him.

Although English was not his native tongue, Magnel spoke the language very eloquently (Figs. 5 and 6) and had the rare gift of being able to simplify complex theories and difficult problems.

On his American lecture tours, he captivated large audiences at Columbia University in New York, the Engineers Club in Baltimore, the University of Illinois in Urbana, and many other engineering groups. Throughout America, he described his prestressed concrete work, enunciating his theories and showing numerous, detailed slides. The March 1947 issue of the *Journal of the Engineering Institute of Canada*^{4,5} clearly says:

"This paper is a resumé of several addresses given by the author (Gustave Magnel) before various Branches of the Engineering Institute of Canada in May 1946, and has been prepared for the *Journal* by special request. *Prestressing is explained in a way that any member of the profession could understand* (Fig. 7). Three methods of prestressing are given and each explained in detail. The economies obtainable by the use of prestressing are given and each explained in detail. The economies obtainable by the use of prestressing make this *short and very clear explanation* a subject of prime interest and importance of today's and tomorrow's engineers."⁶ (Italics are added for emphasis.)

⁶Also see Reference 4 and the Editor's note in the July-August 1954 issue of *Military Engineer*.



Fig. 6. Professor Magnel teaching prestressed concrete.

Two significant events occurred during Magnel's first visit to America which had a direct bearing on the development of prestressed concrete in this country and which culminated in the realization of Philadelphia's Walnut Lane Bridge.

The first event was my introduction of Magnel to the Preload Corporation of New York. At the time, this company was the American leader in the design and construction of circular prestressed structures such as tanks, reservoirs and domes. The Preload Corporation eventually became a sub-contractor for the construction of the Walnut Lane Bridge girders.

Magnel's Book

I believe the most significant effect on the development of linear prestressed concrete in America took place the day before Magnel returned to Europe in 1946. He greeted me in his New York hotel room with the following message: "Before I return to Belgium, I will leave with you the last three copies of a manuscript I have written in French. It is the first comprehensive design and analysis text for prestressed concrete members anyone has ever written. Let me explain it to you . . ." For the next couple of

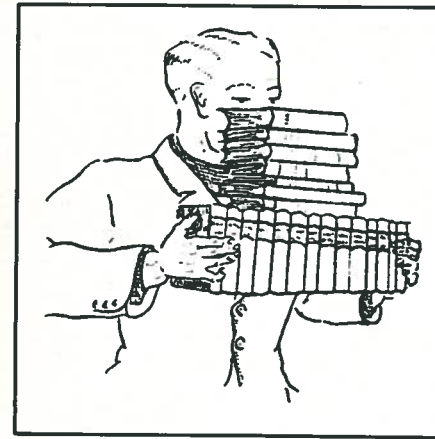

Fig. 7. Professor Magnel's explanation of the principle of prestressing.

hours the Professor proceeded to teach me the fundamentals of the design and analysis of prestressed concrete.

I became so captivated with the clarity and simplicity of Magnel's explanation that I requested permission to translate the manuscript into English for possible publication in an American technical journal. Permission was granted.

However, by the time the translation was submitted several months later, Magnel advised me that he had written a second chapter. Later, there was a third and a fourth chapter, in all, eleven chapters were translated. I could barely keep up with the Professor; no sooner had the translation of one chapter been completed when the Professor had produced the next.

The original manuscript was now sufficiently developed to merit publication as a book: the English version of the French *Le Béton Précontraint*.

Indeed, it was a labor of love. For more than a year, the midnight oil burned. Not only did the text require translation but all drawings, charts, diagrams and tables had to be converted to American measurements. At the time, I could ill afford to have someone else re-draw them.

In addition, the nomenclature had to be modified to American standards. All the examples worked out in the metric system were recomputed to the inch/pound system. The rewards of a job well done were immeasurable if not monetarily so. However, the disappointment was painful when American publishers such as McGraw-Hill, Inc. and John Wiley & Sons turned the book down because they could not as yet see a market for the product.

Concrete Publications Limited of London, however, grabbed the manuscript, retranslated it from "American-English" to "British-English," reworked the nomenclature to conform to British practice and published a first edition of 6000 copies in 1948² (see Fig. 8).

The book promptly sold out. Eight

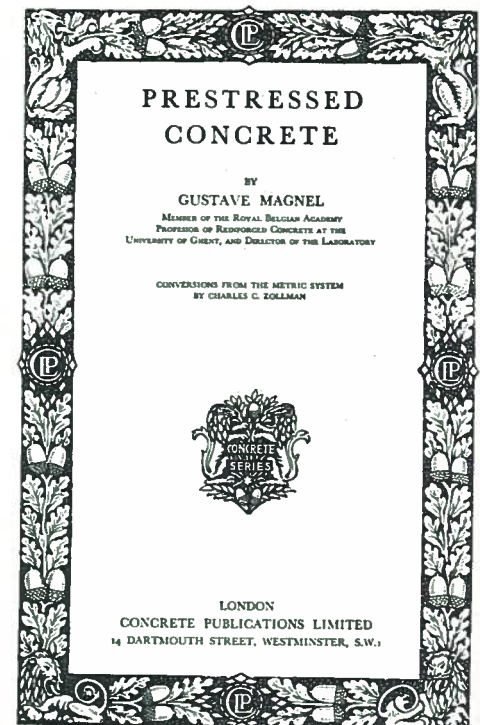

Fig. 8. The first edition jacket of Professor Magnel's book in English on "Prestressed Concrete."



Gustave Magnel

Philosopher • Teacher • Builder
(1889-1955)

People who personally knew Professor Gustave Magnel or were present at his lectures all readily agree on one thing about the man—that he was one of the most effective teachers of his time. Here in slightly edited form are excerpts from some of his more memorable lectures:

● **On complicated formulas**—When I first gave lectures, I used to cover the blackboard with complicated formulas—not on such a tiny one as this but on a big blackboard which has several sections such as are found in the lecture rooms of the Belgian University. I was so proud of myself because I thought I was very clever. But now, since I am older, I have understood that writing complicated formulas does not solve any problems.

● **In explaining the action of prestressing in a statically determinate beam**—Take the simple case of a beam resting on two supports. If we apply a prestress force at the ends of the beam we notice that the beam cambers upwards due to the prestressing moment (prestressing force times its eccentricity). At the completion of prestressing, the beam still rests on the two end supports. What are the reactions on those two end supports? Well, if everything is symmetrical, the reaction at each support is equal to one-half the weight of the beam. What else could it be? And whether we apply a very large prestress force or a small prestress, each reaction is always equal to one-half the weight of the beam. It is statically determinate.

● **In explaining continuity in a prestressed beam**—Let us now consider a continuous beam having two equal spans. We prestress the beam with wires going from one end to the other.

Assume for the time being that the central support is missing—the beam would also curve upward like the simply supported beam. But the central support is there and it says to the beam, “Hey, my little beam, please you may not lift up, I’m keeping you down.” In other words, the support can only keep that beam down by exerting an external force, i.e., an anchorage force downward—and that is only possible due to simple statics, if we have at each of the outside supports an upward reaction equal to one-half of the anchorage force. With these new forces acting on the beam, we have a new kind of bending moment diagram. In fact, it means that we get so-called “secondary moments” in the beam. These secondary moments are great or small, positive or negative depending on the magnitude and shape of the stressed cable and the cross section of the beam.

● **On Hooke’s Law**—We need to develop a reliable theory with which to proportion and reinforce a beam based on its moment of rupture. Unfortunately, in a real case we can no longer apply the laws of elasticity. Don’t forget that a design based on a calculation of stresses is nothing more than the development of the assumption that Hooke’s Law is applicable, i.e., that stress is linearly proportional to strain ($\sigma = E\epsilon$). Hooke’s Law happens to be the only thing that civil engineers know



for sure in their calculations—but it happens to be wrong for most materials. Yes indeed, engineers don’t know anything else—sure enough they modify it, they call it the Theorem of Three Moments, Theory of Least Work, and Formulas for Bending and Torsion. But it is always Hooke’s Law written in red or green, English, German or Chinese—and it is wrong most of the time!

● **On safety factors**—Everybody loves to talk about safety factors but nothing is more complicated or confusing. It is meaningless to talk about safety factors unless you explain what it is related to for a particular case. (Does it, for example, relate to cracking, breaking or fatigue strength?) To just say that you have a safety factor of 2, 2.5, 2.7, or 3 has no meaning. That depends more on one’s bank account! Ja, if you can afford to spend a lot of money—if you are, say, the president of General Motors or somebody like that, you see it doesn’t matter how strong you make the beam—you can afford to have a safety factor of 3 or more. However, if you have a very tight budget, you will probably use a safety factor of 2 (but it must be at least 2).

● **On a lecturer’s role**—Why are we here together? It is to learn something from one another. If I say “Yes” to everything you believe, then there is no reason for my being here.

● **On corrosion of prestressing steel**—Beware of corrosion! Remember that when wires are placed in a duct they are in a wet, moist atmosphere and in contact with the air. The wires must be surrounded with grout and must never touch one another.

● **On the true behavior of a member**—There is only one authority in the world who knows what happens in a beam—and that is the beam itself. My method is to go directly to the beam and ask it “Say my dear, tell me what are your stresses? What is your moment of rupture?”

● **On model testing**—If you want to derive meaningful conclusions, perform your tests on real big beams (60, 70, 100 or 150-ft spans)—not toys of 3 or 4 ft long, 2 or 3 in. deep, which I call confidential beams.

● **On false prophets**—Beware of people who are trying to sell you new patents or prestressing systems. Most of the time these people know very little about engineering or prestressing principles. These devices are only worth considering after full-scale testing.

● **On professional ethics**—If you cannot design a prestressed concrete structure on a sound and economical basis, don’t build it! Above all, be an engineer with a professional conscience. Make the structure right!

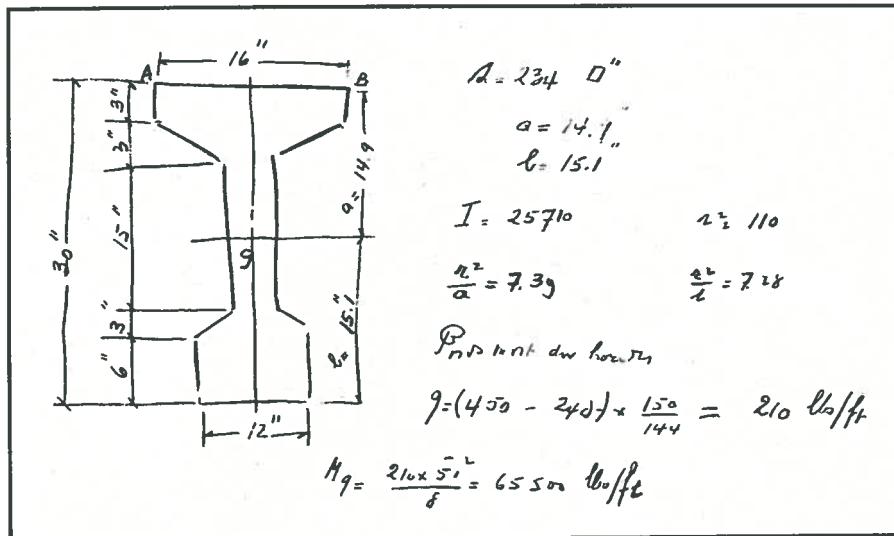

Fig. 9. Portion of an original calculation sheet in Magnel's own handwriting.

thousand copies of the second revised and expanded edition were published in 1950 and a third further expanded edition was published in early 1954.

In view of the book's unexpected success, McGraw-Hill of New York purchased the reprint rights of the third edition, late in 1954.

I am convinced that most copies of the early editions made their way into the United States and Canada, the only major English speaking countries. (Until 1955, when T. Y. Lin published his book on *Design of Prestressed Concrete Structures*⁶, Magnel's book was the only English text treating the subject.)

During those early years Magnel's book was the practical tool to which engineering students and practicing engineers referred to for the design and analysis of prestressed concrete structures. The impact this treatise (as well as many of Magnel's other publications*)

*Magnel was a prolific writer. He published about 200 technical articles and books between 1910 and 1955.

**The Virginia Construction Company is now called Basic Construction Company, Inc.

had on the prestressed concrete industry is indeed significant.

The basic principles, charts, and nomographs generated the necessary confidence in the design of the new material and served as the basis for prestressed concrete publications and engineering practice for many years thereafter.

Fig. 9 shows a portion of an original calculation sheet in Magnel's own handwriting.

The Preload Corp.

During the forties, the Preload Corporation was awarded a sub-contract from the Virginia Construction Company, Norfolk, Virginia** to construct eight prestressed concrete digestion tanks for Philadelphia's North-East Sewerage Disposal Plant.

Preload Corporation thus was in a strategic position to promote linear prestressed concrete in Philadelphia. This can be seen in the following extract from a June 5, 1948, letter to Charles C. Sunderland, Chief Engineer of the John A. Roebling & Sons Company from E. R.

Schofield, Principal Assistant Engineer in the Department of Public Works, Bureau of Engineering, Surveying and Zoning, Philadelphia:

"Since I saw you last April several things have happened to our Walnut Lane Bridge. The Pre-Load Co. (sic) who are building some digestion tanks for us requested permission to study the problem. Although I did not like the situation I could hardly refuse, my position being what it is. At the time I was very enthusiastic about Mr. Coff's* plan but did not like the probable erection difficulties. . .

"In studying the proposed Walnut Lane Bridge, the Preload Corporation went to Europe and hired Professor Magnel. He proposed a prestressed girder bridge similar to those which had been built in Europe. Part of that proposal was to make girders with an 'I' shaped cross section and with a uniform depth of about 6 ft 6 in. (2 m).

"... Please note that the intention is to cast the 'I' section girders at the site and place them in position on the piers and abutments by launching. The girders will be pulled together by transverse wires placed at the top and bottom of the diaphragms [about 14 ft (4.3 m) apart]. The tops of adjacent 'I' sections will touch each other on the main span and the wearing surface will be placed directly upon the tops of the I's. On the approach spans every other girder is omitted and the deck becomes a poured-in-place problem as are the cantilever sidewalk brackets of the main span. . .

"... There are several things I like about this solution, the first being the economy of one set of molds or forms for all girders, another being the fact that enough bridges have been and are being built in Europe to have established precedents for the basic design and method of prestressing and erection."

Some months before this letter had been written, I had joined the Preload Corporation as Design Engineer and was assigned to the task of promoting, developing and designing linear pre-

stressed concrete structures using the Blaton-Magnel cable system and anchorages.

This was a logical assignment in view of my relationship with Professor Magnel and my knowledge of European and American design and construction practices.

It was in this capacity that I presented Magnel's plan in the early spring of 1948. I entered Ed Schofield's office, stood in front of his desk, faced him, and slowly unrolled the large drawing Professor Magnel had developed showing a plan, elevation, cross section and a rendering of a proposed prestressed concrete Walnut Lane Bridge.

As I stood there, silently holding up the drawing, Schofield examined it intently (his eyeglasses on the tip of his nose) and then pronounced the magic words we all had hoped to hear: "Yes, that's what I want"—let me have the drawing." He hurried off, drawing in hand, but soon returned and said, "They like it upstairs."

"Upstairs" meant the offices of the Philadelphia officials for the Bureau of Engineering, Surveys and Zoning. These officials included Thomas Buckley, director; A. Zane Hoffman, chief engineer; and Samuel Baxter, assistant engineer. Edward Schofield was then the principal assistant engineer. "They like it," was tantamount to a final approval but Schofield said, "Well, we need one more approval. Let's go."

Ed Thwaits (at the time, vice-president and sales manager for the Preload Corporation)** had accompanied me and, together with Schofield, we set out for the office of Roy Larson, architect and

*L. Coff, a consulting engineer in New York, had developed, as consultant to John A. Roebling & Sons Company, a prestressed concrete box girder of variable depth for a Walnut Lane Bridge using cables made up of galvanized strands provided with sockets and swage terminal for anchorages, and bridge saddles over transverse diaphragms, similar to the cables used in suspension bridges.

**Ed Thwaits is now 85 years old and lives quietly in Denver, Colorado.

chairman of Philadelphia's Art Commission. Any proposed public structure in Philadelphia is subject to approval by the Art Commission but with particular scrutiny if located in beautiful Fairmount Park, the largest park to be contained within a city's limits.

As we waited, Schofield again went "upstairs" but returned all smiles saying, "Well, that's finished business. Larson approved it. It's lunchtime; let's have a bite to eat." We were all elated. The drama and suspense was over. Walnut Lane Bridge as it now stands was accepted there and then after another version, a single 212-ft (64 m) simply supported span, had been rejected by Schofield as being too daring.

One should bear in mind that a public transportation official has the enormous responsibility of protecting the life and safety of the public. To convince a public official of the merits of a new construction method is a difficult task, particularly since Americans advocating its use only had a second-hand knowledge of prestressed concrete. It takes vision, daring and courage for a public official to accept the challenge and to proceed with such a project.

Contractor Emile Blaton said it well:

"Ah! Those Americans. They have guts. When we started prestressed concrete, we built first a beam having a 20-ft (≈ 6 m) span, then, when we had learned how to do that well, we made a 40-ft (≈ 12 m) beam, and then a 50-ft (≈ 15 m) beam, we progressed step by step. But the Americans! No, they have to start their first prestressed concrete bridge with 160 and 74-ft (≈ 49 and 23 m) spans."

And he shook his head in disbelief.

It was the culmination of several months of persistent hard work by Professor Magnel, his staff, the Belgian contracting firm of Blaton Aubert who held the patent rights to the anchorage system as builders of many Belgian prestressed structures, and the staff of the Preload Corporation.

Constructing the Walnut Lane Bridge

In retrospect, one now sees how the project fell into place: The roles of the Belgian-American Educational Foundation, Gustave Magnel,⁸ the laboratory testing of full-sized beams, the manuscript, the business acumen and drive of the Preload Corporation, and finally the vision and daring of Philadelphia officials of the Bureau of Engineering, Surveys and Zoning.

Magnel's manuscript, in my handwriting, proved invaluable because it gave Schofield and Baxter the necessary confidence in the design methods and testing methods and results of full-sized members developed by Magnel.

What remained were months of intense office work. Between Magnel's office in Ghent, Preload's in New York and the Bureau of Engineering of the City of Philadelphia, design and detail work had to be coordinated. A complete set of construction drawings and specifications in accordance with American practice required preparation.

Most of the detail work was carried out by Ted Gutt* under my supervision. Gutt was part of Preload's staff and later became resident engineer and field supervisor for construction of California's first prestressed concrete bridge, the Arroyo Seco Pedestrian Overpass.

By late summer of 1948, the City's contract documents were completed.

Fig. 11 (on the next two facing pages) shows two of the original contract drawings (simplified).

It is worth noting that the contract included a clause requiring testing, to destruction, a full-sized main span girder of about 160 ft (48 m) at the bridge site.^{9,10}

Fig. 10 shows portions of Magnel's

*Ted Gutt is presently the Chairman of PCI's Plant Certification Committee and an Assistant Vice-President of the Prestressed and Architectural Concrete Division of the Tanner Companies.

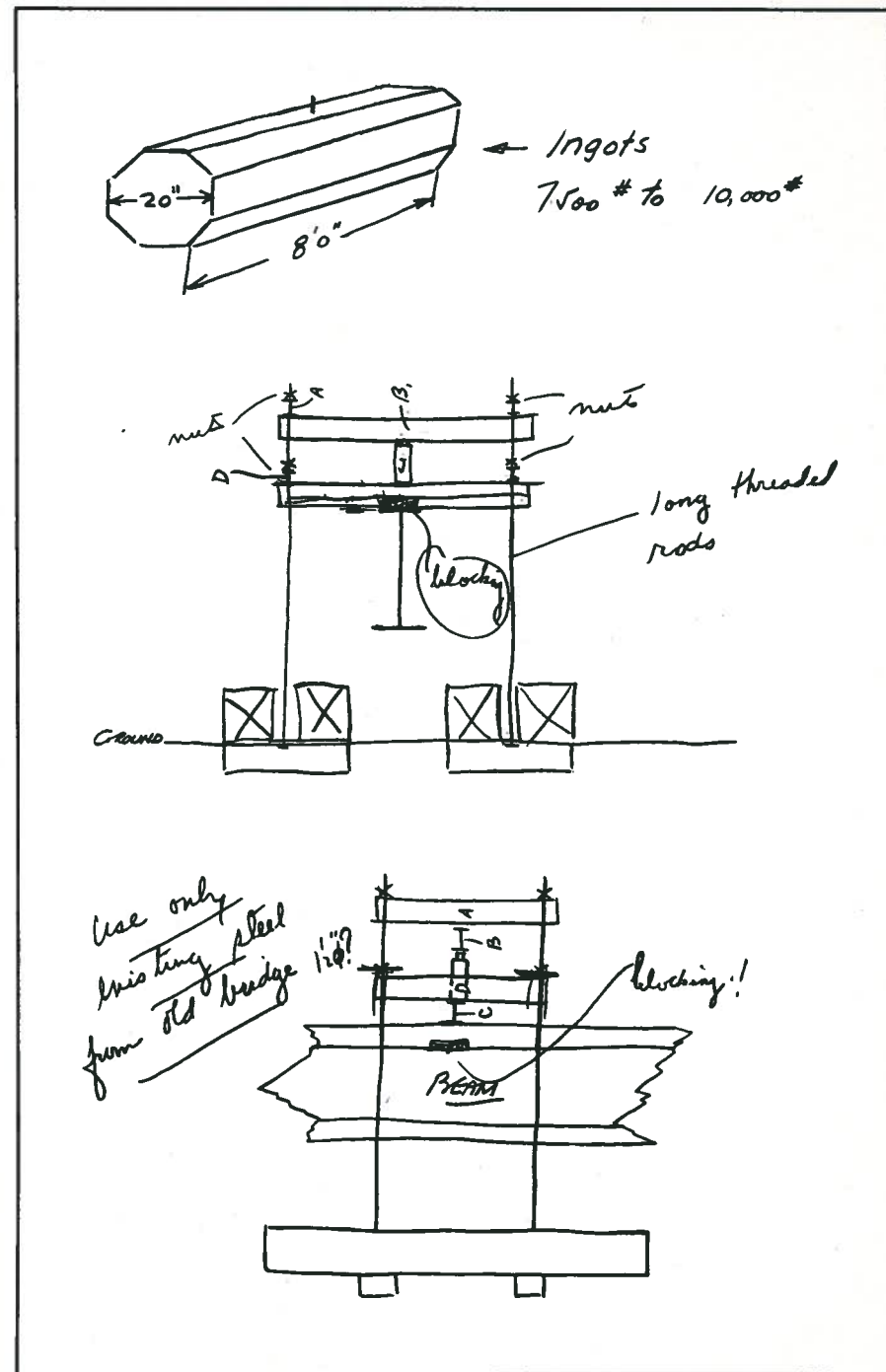

Fig. 10. Portions of Magnel's original rough sketches of the proposed testing arrangement for a 160-ft (49 m) girder used in the main span of the Walnut Lane Bridge. For contrast refer to the actual drawings (see Fig. 15).

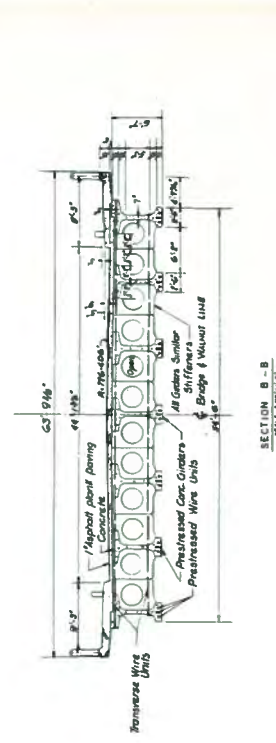
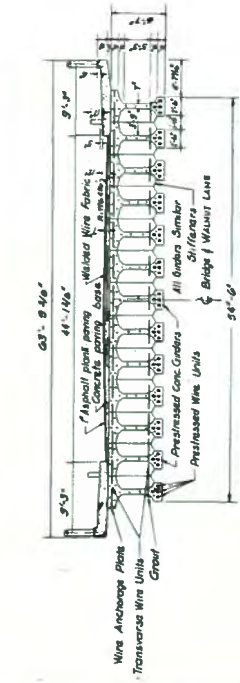
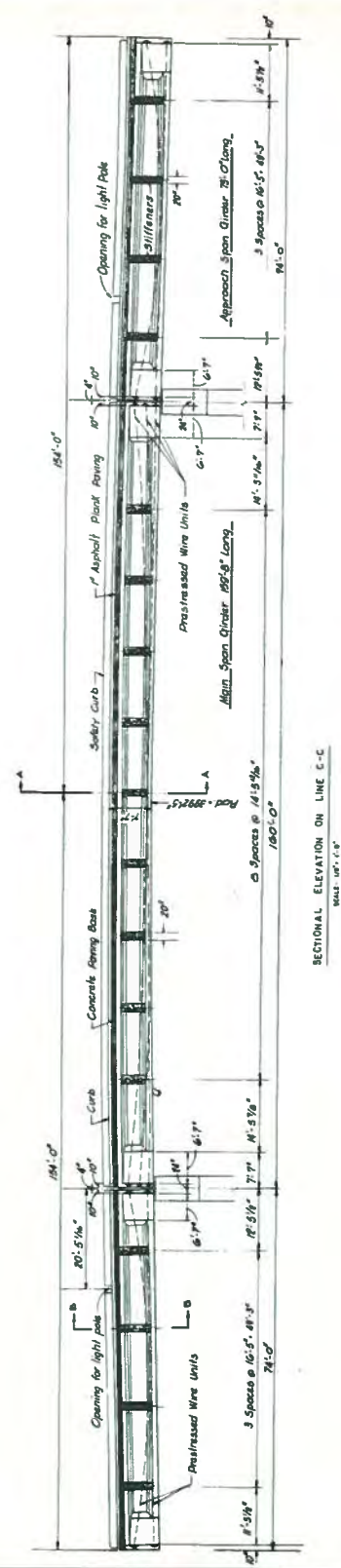
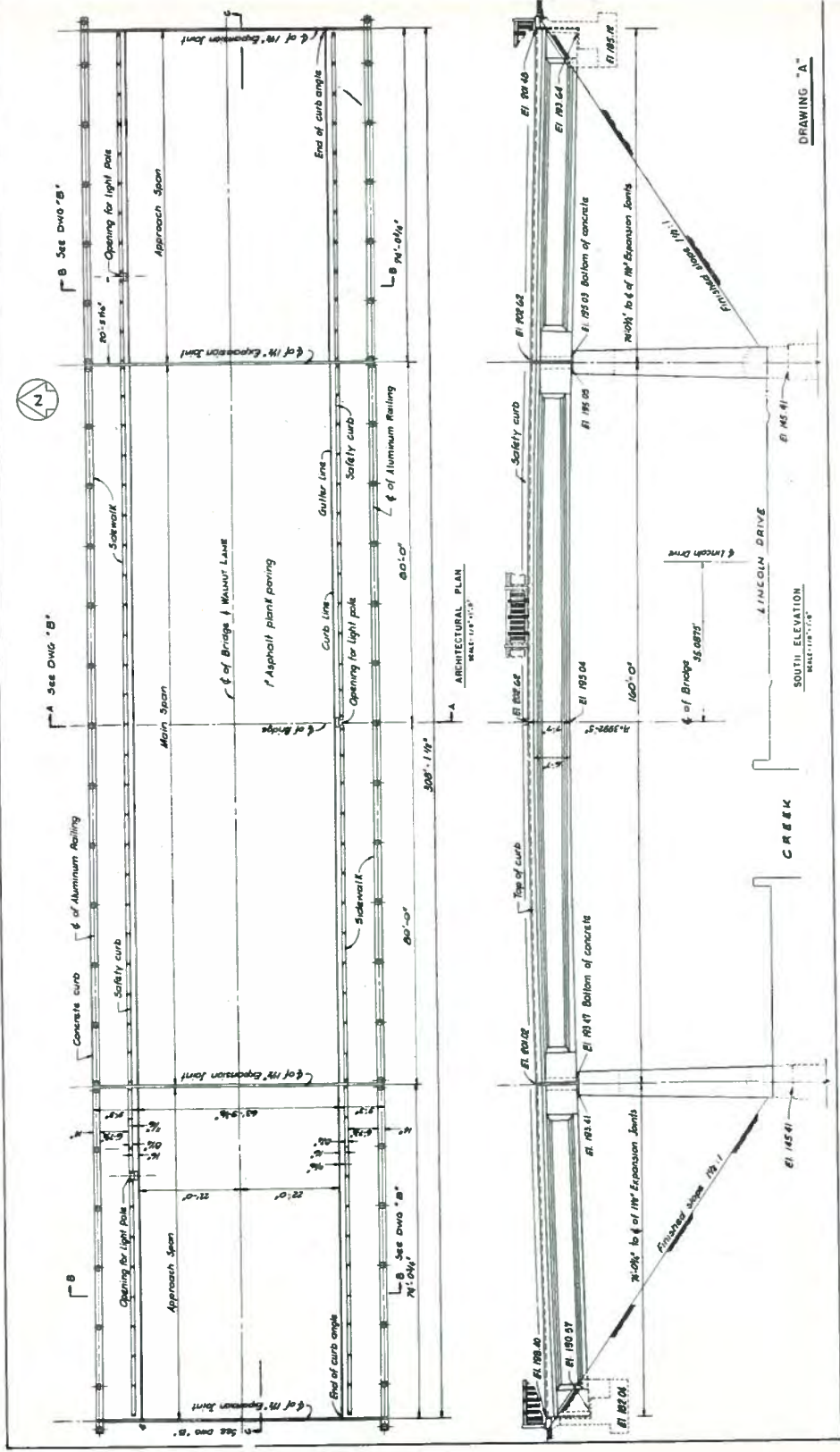

Fig. 11. Original contract drawings (with some detail simplification) of Walnut Lane Bridge showing the plan, various elevations and typical cross sections of the structure.

IMPORTANT FIRST—Look for bids to be asked soon for a prestressed concrete bridge, first in the U. S. Look also for an article on it in a near-future issue of this journal. Philadelphia's department of public works has been quietly designing the structure these past several months. Of deck-girder type, it will have a center span of 160 ft., end spans of 74 ft. The largest of the girders will weigh 150 tons. Precast, they will be lifted into place 50 ft. above a drive in Fairmount Park.

original rough sketches of the proposed testing arrangement for a 160-ft (49 m) girder of the Walnut Lane Bridge.

Bids were let on January 19, 1949 (see Fig. 12) leaving only one unexpected hurdle to overcome.

A joint venture of Corbetta Construction Company and Raymond Concrete Pile Inc. submitted a low bid based on

Fig. 12. "The Philadelphia Inquirer's" announcement of the bid opening for the Walnut Lane Bridge, December 1, 1948. Bids were taken on January 19, 1949. The contract was awarded in the spring of 1949.

an alternate Freyssinet design. After protracted discussions, the bid was rejected as not conforming to the contract documents.

This alternate design called for 14 girders in the main span whereas the basic design consisted of 13 girders. Indeed, the Freyssinet stressing jack, at that time, was unable to pull the force pro-

vided by 0.276-in. (7 mm) diameter wires but was limited to pulling 0.196-in. (5 mm) diameter wire.

It was not possible to accommodate the large number of 0.196-in. (5 mm) wires required in 13 girders. Therefore, with the alternate design a 14-girder main span was essential. This caused an esthetic problem in aligning girders when the approach spans were taken into consideration.

A contract was finally awarded in the Spring of 1949 to the Henry W. Horst Company for the construction of the original design in the amount of \$698,383; the second lowest bid was \$705,706.50.¹¹ The Preload Corporation was awarded the sub-contract to fabricate the girders.

Load Testing to Destruction

Testing of the 160 ft (49 m) long and 6 ft 7 in. (2 m) deep girder, identical to the girders forming the center span of the bridge, was conducted on October 25, 1949 (see Fig. 13) adjacent to the site of the bridge. This test demonstration attracted some 300 engineers from seventeen states and five countries—England, Cuba, Mexico, Canada and Belgium—who stood in the rain for the entire day to witness the drama.¹²

Professor Magnel himself (Fig. 14) supervised the formal test demonstration and provided his appreciative audience with a running commentary (interspersed with his usual witty humor despite the rainy conditions) on the progress of the test.

To the astonishment of some skeptics, the Professor correctly predicted the behavior of the girder during each loading phase and foretold the favorable outcome of the load test.

Fig. 15 is a diagram of the typical jacking frame and Figs. 16a and 16b show the general testing arrangement and details of the testing frame, respectively.

Figs. 17 and 18 show the behavior of the girder during its various testing



Fig. 14. A very happy Professor Magnel conducted the test demonstration and delighted the spectators with his humorous running commentary.

stages from initial loading to final destruction.

The girder had to be loaded to between 10 to 11 times its working load, i.e., loads were gradually increased to 5000 lbs per lineal ft (≈ 7500 kg/m), to cause failure. Failure occurred through compression of the concrete in the upper flange.

This 5000 lb per lineal ft per load corresponds to a total superimposed load of some 800,000 lbs ($\approx 360,000$ kgs). At this point the deflection at midspan of the 160-ft (≈ 49 m) long beam was only slightly more than 15 in. (≈ 38 cm).

It is noteworthy to mention that the first crack occurred at an equivalent load of 1400 lbs per ft (≈ 2100 kg/m). The deflection was only 11/16th of an inch (≈ 2 cm).

As the loading was continued, the crack widened but at a load of 1500 lbs

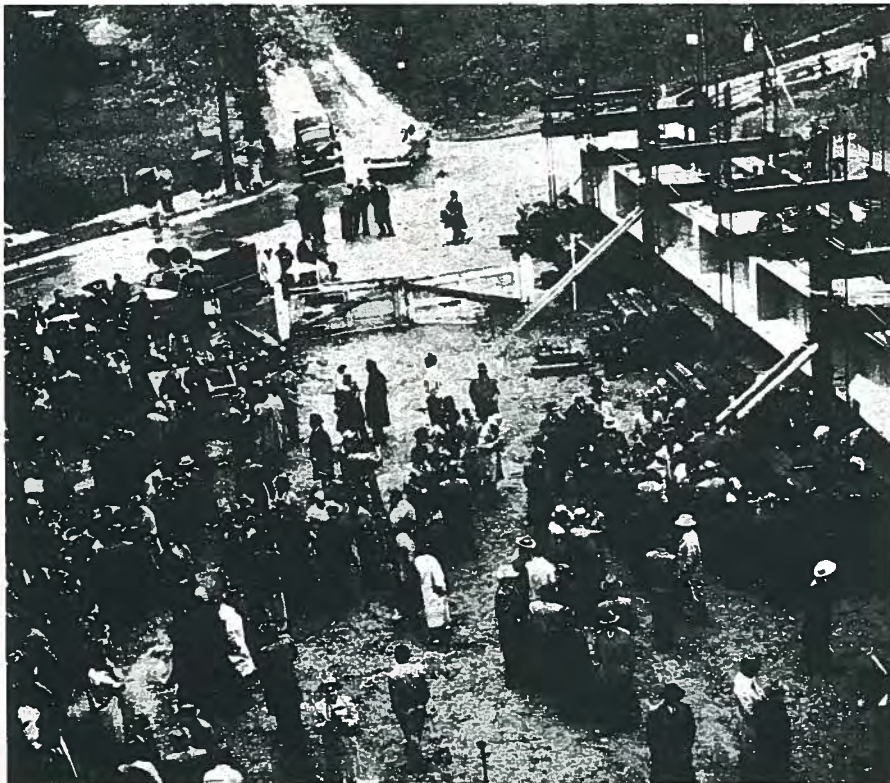

Fig. 13. Over 300 engineers from 17 states and 5 countries witnessed the formal testing to destruction of an identical girder used in the main span of the bridge.

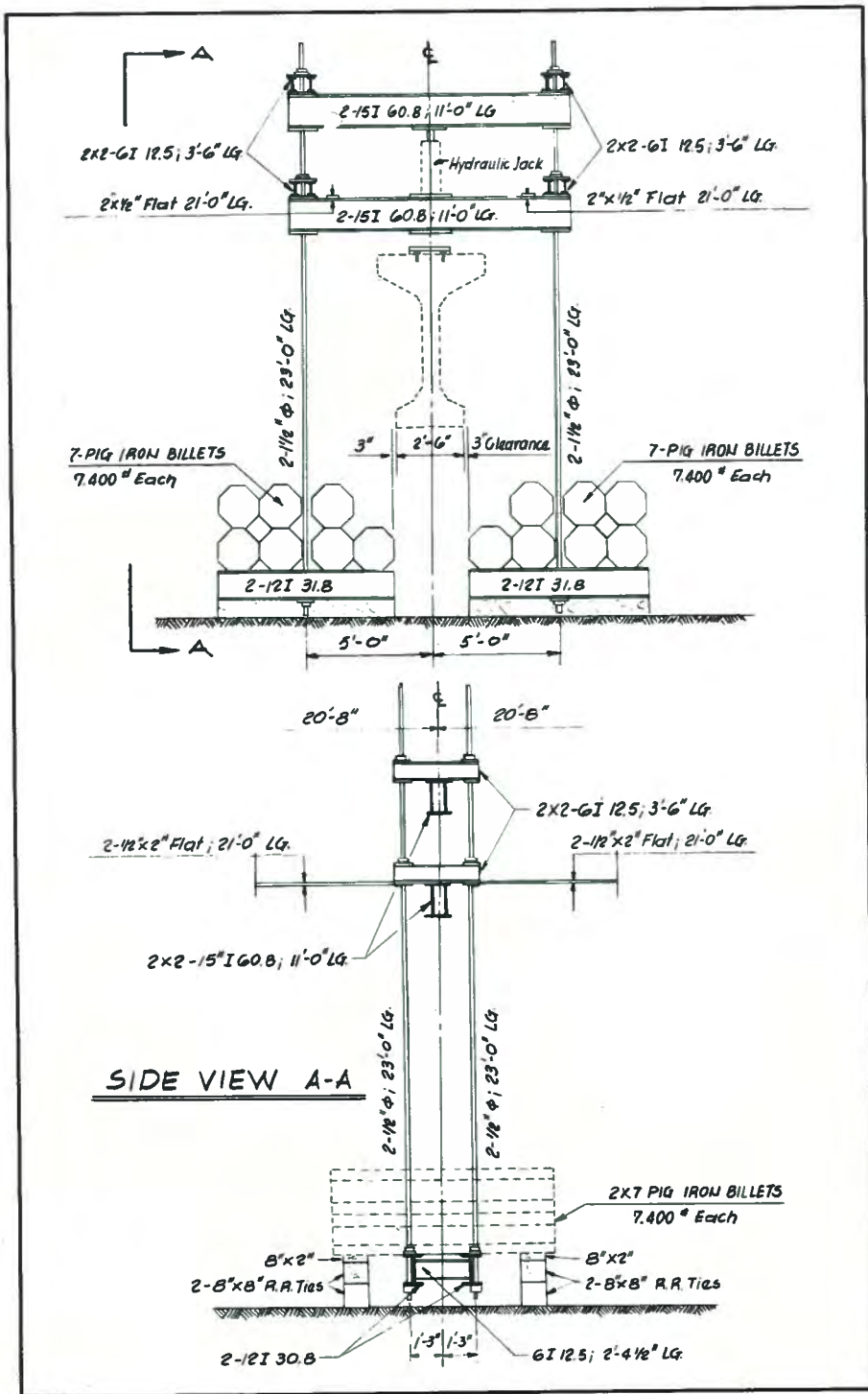

Fig. 15. Elevation and section of typical jacking frame (for contrast see Fig. 10).

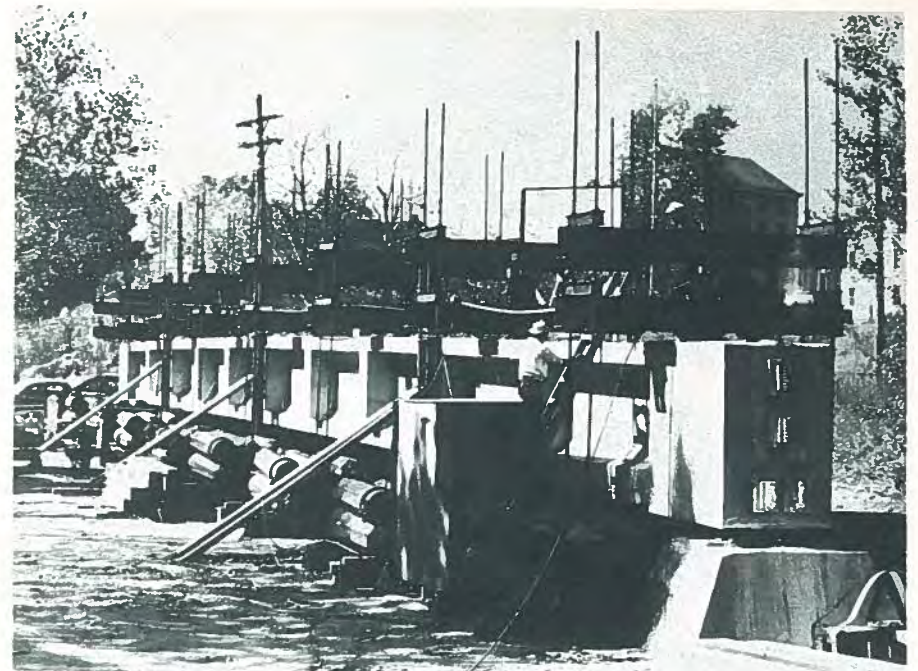

Fig. 16a. General testing arrangement.

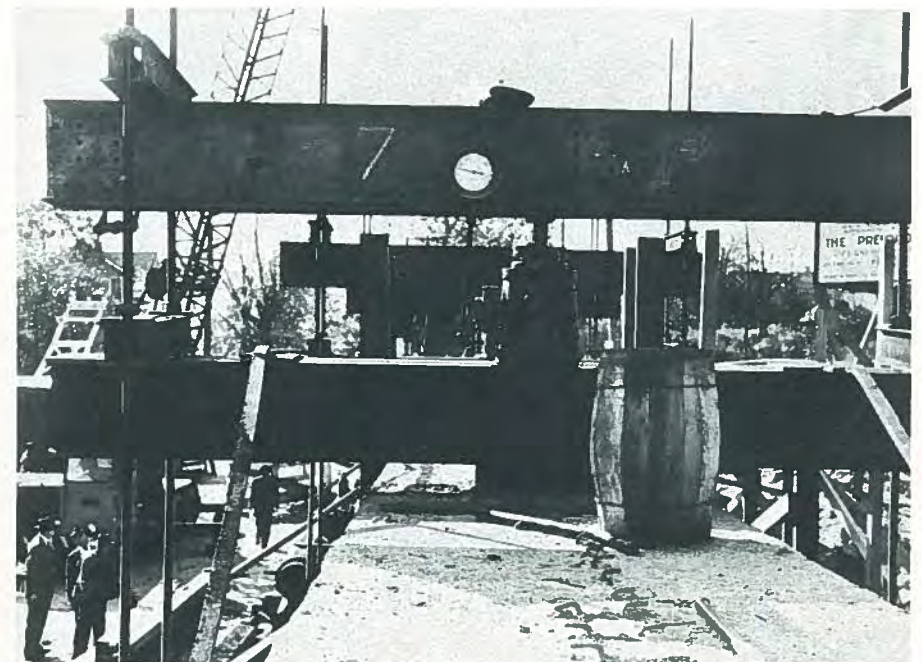
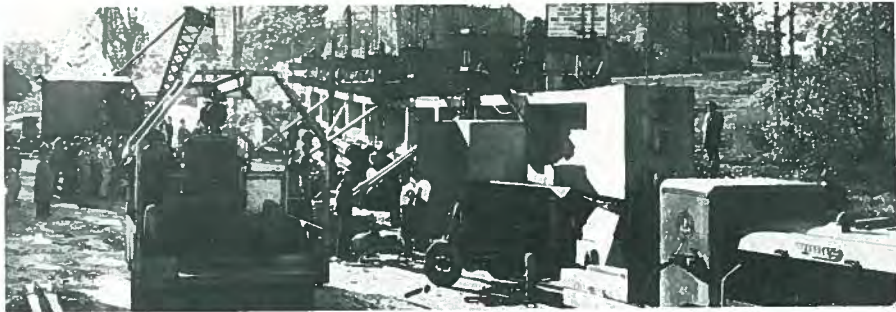

Fig. 16b. Closeup of testing frame.



(a) Deflection of girder prior to failure.



(b) Girder at moment of failure.



(c) Girder after failure.

Figs. 17. Although the girder did not fail at the designated testing load "informal" testing continued the following day (ironically, in clear sunny weather). The girder finally cracked at the superimposed load of more than 1.2 million lbs.

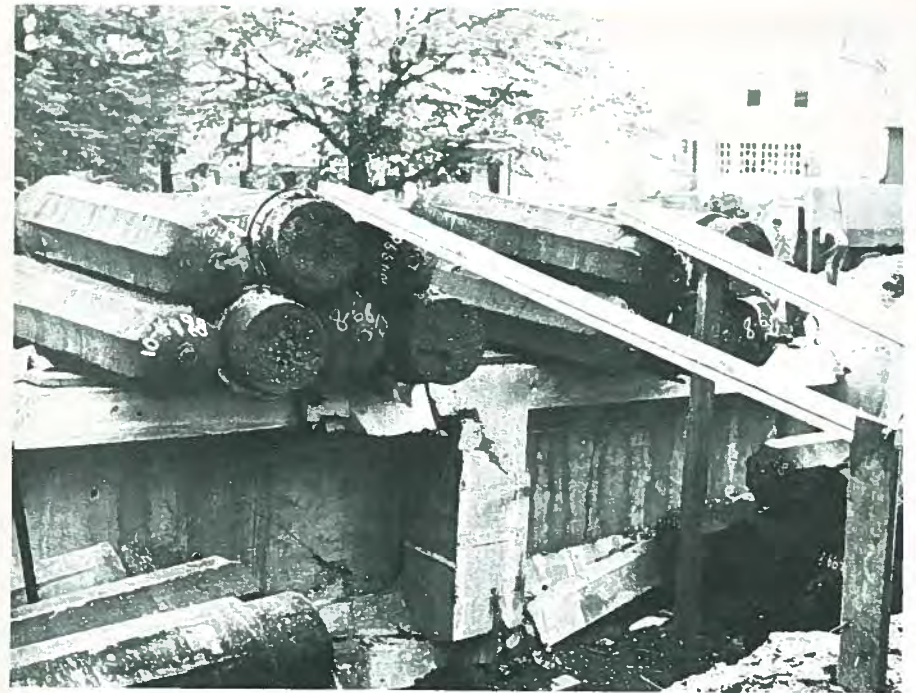

Fig. 18a. Closeup of failure at midspan.

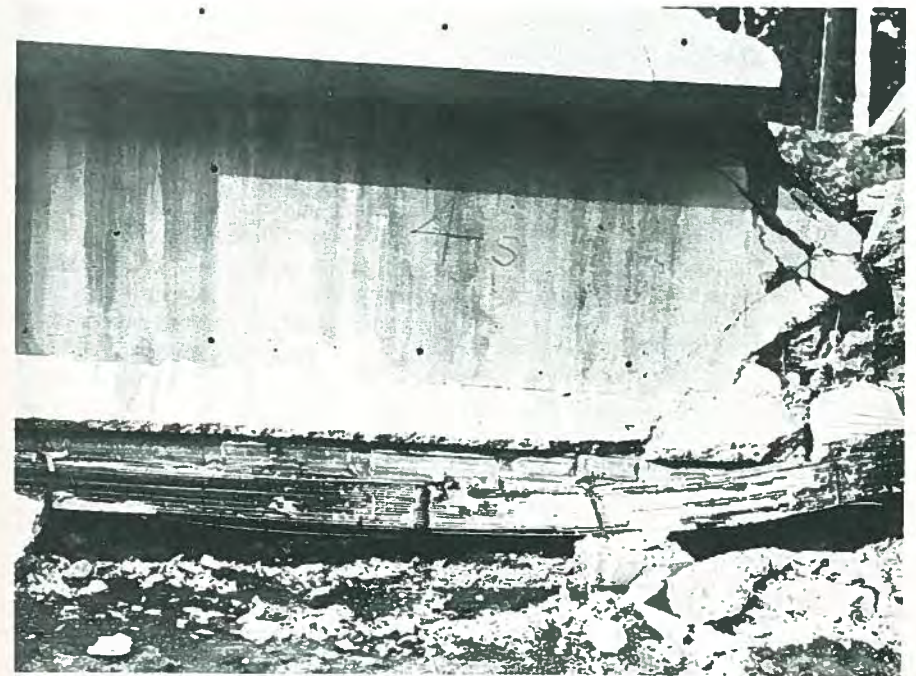

Fig. 18b. Closeup of failure due to moments.



Fig. 19. A year before Magnel's death, the Professor (center) admires the Walnut Lane Bridge with Charles Zollman (left) his former student and good friend, and Samuel Baxter (right).

per ft (≈ 2200 kg/m) other cracks appeared in the panels next to the central stiffener. Up to this time, there was no noticeable deflection in the girder.

The formal test was arranged to simulate uniform loading throughout the length of the girder. This was accomplished by means of eight jacks placed 20 ft 8 in. (6.3 m) on center on top of the girder (see Figs. 16a and 16b).

Again, it should be noted that although load testing was continued for most of the day, the girder did not fail that day.

The next day (a beautiful day in contrast to the previous one), after the ingots had been rearranged the beam was destroyed.

For the record it should be mentioned that Dr. Arthur R. Anderson (at the time a consulting engineer in Springdale, Connecticut) was in full charge of the delicate instrumentation, the strain readings and the deflection measurements.

The successful testing to destruction at the job site (and in front of a large audience) of the 160-ft (49m) long girder, 6 ft 7 in. (≈ 2 m) deep and weighing an average of 2000 lb per ft (3000 kg/m), far away from the comforts of a laboratory, was a significant achievement which instilled public confidence in prestressed concrete.

To have devised simple but sufficiently accurate means for synchronizing and controlling load increments at eight different locations along the girder is a credit to American engineers. For none of these techniques had been previously associated with linear prestressing.

After the bridge was completed, Professor Magnel visited the site with his old friends to admire the structure (see Fig. 19 and 20).

The Aftermath

After the contract was awarded to the Henry W. Horst Company, a group composed of those responsible for constructing the Walnut Lane Bridge travelled to Europe to inspect prestressed concrete construction (especially bridges).¹³ The group included Anthony Horst of the Henry W. Horst Company, Robert Petersen and Ben Baskin of Concrete Products of America,* Sam Baxter, Ed Schofield and myself.

We were met at the Brussels airport by Professor Magnel who joined us in a sumptuous dinner. Tony Horst, who had

*In 1949, they built the first American pretensioning plant for the manufacture of box girders, at Pottstown, Pennsylvania. Another first!

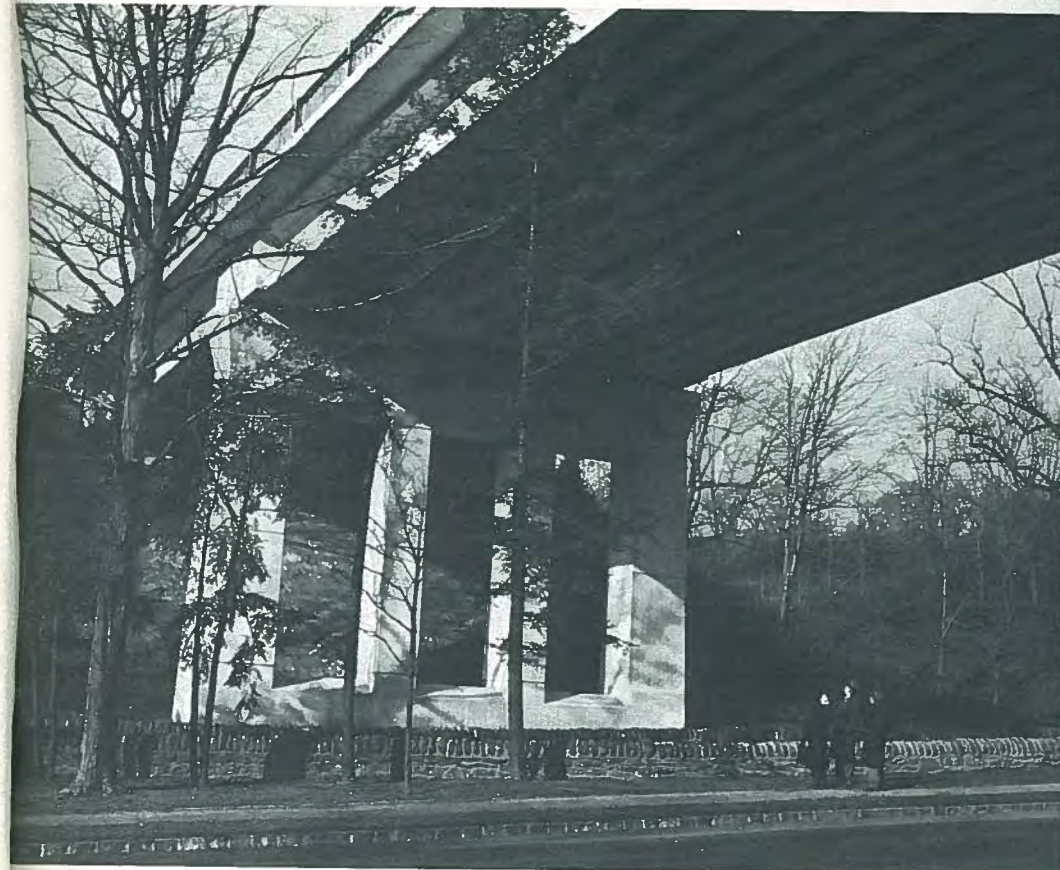

Fig. 20. The completed Walnut Lane Bridge and the men responsible for its construction; (from left to right) Prof. Magnel, Samuel Baxter (ASCE) and Charles Zollman (author of this paper).

been extremely concerned about the concrete strength and slump specifications asked Professor Magnel, "Is it true that you requested zero slump?" The Professor answered with a smile, "I am not talking about zero slump, I am talking about 'minus' slump." But then, that is another story.

And so is the one about William A. Dean, one of the men instrumental in developing prestressed concrete, especially in Florida. In 1949, I met Bill Dean, then bridge engineer for the State of Florida. He greeted me by saying, "I have gone sour on prestressed concrete."

However, shortly afterward, Dean did proceed with the design of the 17,500 ft (≈ 5300 m) long prestressed concrete Sunshine Skyway Trestle between Bradenton and St. Petersburg, Florida. In 1957, he received ASCE's distinguished Ernest E. Howard Award for "achievements in the design and construction of prestressed concrete."

The ball was beginning to roll—soon to pickup momentum in Florida, the Midwest, and on the West Coast.

The second part of this article will reveal how the ball was made to roll making the prestressed concrete industry a giant in American construction.

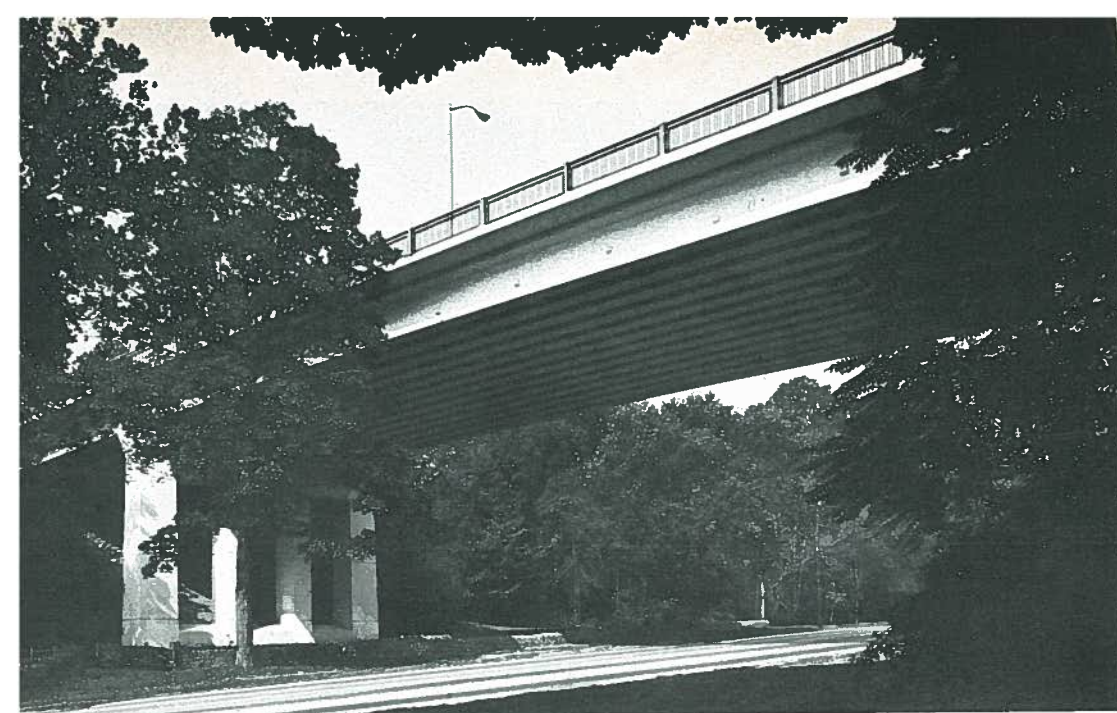

Fig. 21. Walnut Lane Bridge as it looks today.

References

1. T.Y. Lin Symposium on Prestressed Concrete: Past, Present, Future, PCI JOURNAL, V. 21, No. 5, Sept.-Oct. 1976, 224 pp.
2. Magnel, Gustave, *Prestressed Concrete*, Concrete Publications, Ltd., London, First Edition, 1948, p. 113 and McGraw-Hill Book Co., Inc., New York, Third Edition, 1954, p. 9 and 136.
3. Dunham, Clarence W., *The Theory and Practice of Reinforced Concrete*, McGraw-Hill, Inc., New York, 1939, Chapter 16, "Practical Details and Miscellaneous Data."
4. Magnel, Gustave, "The Principles of Prestressed Concrete," *The Journal of the Engineering Institute of Canada*, March 1947.
5. Magnel, Gustave, "The Principles of Prestressed Concrete," *The Military Engineer*, July-August, 1954.
Note: Whereas Reference 4 refers to "basic principles," Reference 5 applies to "advanced principles" in connection with continuity, ultimate design, building codes, structural steel and so forth.
6. Lin, T. Y., *Design of Prestressed Concrete Structures*, John Wiley & Sons, Inc., New York, 1955.
7. Schofield, E. R., "First Prestressed Bridge in the U.S.," *Engineering News Record*, December 30, 1948.
8. "In Memoriam—Gustave Magnel," Memorial Assembly in the Rotunda, Ghent University, October 13, 1956.
9. Bowman, Waldo, "Full-Size Prestressed Girder Tested," *Engineering News Record*, November 3, 1949.
10. "Testing Prestressed Concrete Girder," *Concrete Magazine*, V. 57, No. 12, December 1949.
11. Schofield, E. R., "Construction Starts on Prestressed Concrete Bridge in Philadelphia," *Civil Engineering*, July, 1949.
12. Weart, William G., "5,000 Pounds Per Foot Pressure Fails to Snap New Type Girder," *The New York Times*, October 26, 1949.
13. Schofield, E. R., "Prestressed Concrete Used for Boldly Designed Structures in Europe," *Civil Engineering*, September 1949.



Part 2— Dynamic American Engineers Sustain Magnel's Momentum

by
Charles C. Zollman

Part 2

Dynamic American Engineers Sustain Magnel's Momentum



Charles C. Zollman
Consulting Engineer
Newtown Square, Pennsylvania

In a free and competitive society such as ours, stagnation spells doom.
(Evelyn H. Harris)

The momentum generated by Professor Gustave Magnel (culminating in the construction of the Walnut Lane Bridge) carried across North America. Reluctantly at first, then enthusiastically, American engineers and contractors learned the necessary skills so as to be able to use prestressed concrete for their structures. Then in typical American fashion, to maximize the potential of prestressed concrete, they conceived new construction methods, innovated new devices and improved existing prestressing techniques.

How did all this come about?

- What were the lessons we learned from the Walnut Lane Bridge?
- How did Professor Magnel's insistence on high quality materials and workmanship ultimately lead to the acceptance of steel forms and external vibration, the horizontal mixer and high strength concrete?
- Who was responsible for the development and subsequent use of stress-relieved wire and seven-wire strand, essentially an American innovation which revolutionized the industry?
- How did the first pretensioning plant come into being in North America and what were the early types of precast concrete products?

The author discusses the lessons learned from the Walnut Lane Bridge and narrates the events leading to the development of stress-relieved seven-wire strand and the advent of the first pretensioning plant in North America.

He emphasizes the major role William Dean played in approving the design and construction of the Tampa Bay Bridge and especially in establishing standardized bridge beams for the industry.

- How did the prestressed block beam come about which is also a totally independent American development?
- What were the events leading to the construction of the Tampa Bay Bridge, an important structure which sustained the momentum created by the Walnut Lane Bridge?
- Why was the influence of William Dean, an open-minded talented public servant with no real preferences, so decisive to the growth of the young precast prestressed industry?
- How did standardization of bridge beams get initiated?

The above are some of the questions for which I will attempt to provide answers. But more importantly, this narrative is an intensely human story reflecting courage, failure, inventiveness, coincidences, tragedy and triumph.

Quality of Materials and Workmanship

Despite the gradual "Americanization" of prestressed concrete construction in

those early days, the influence of Professor Magnel continued to be felt. Regarding one particular aspect of prestressed concrete, the Professor was uncompromising, namely, his insistence on workmanship and the quality of the component materials of prestressed concrete.

This particular point came to light dramatically in the spring of 1949 when a group made up of those responsible for constructing the Walnut Lane Bridge visited Europe to inspect prestressed concrete construction (see the "Aftermath" at the end of Part 1 of this series of papers).

Anthony Horst, general contractor for the Walnut Lane Bridge, asked Professor Magnel during a dinner meeting, if it were possible to attain "zero slump." With a smile, Magnel answered that he would have liked to specify "minus slump" for the concrete of the Walnut Lane Bridge. He continued, "Tomorrow, at my laboratory in Ghent, in your presence, I will batch no-slump concrete and you will see water coming to the surface." And that's exactly what happened!

Tony Horst, who was used to "pour-

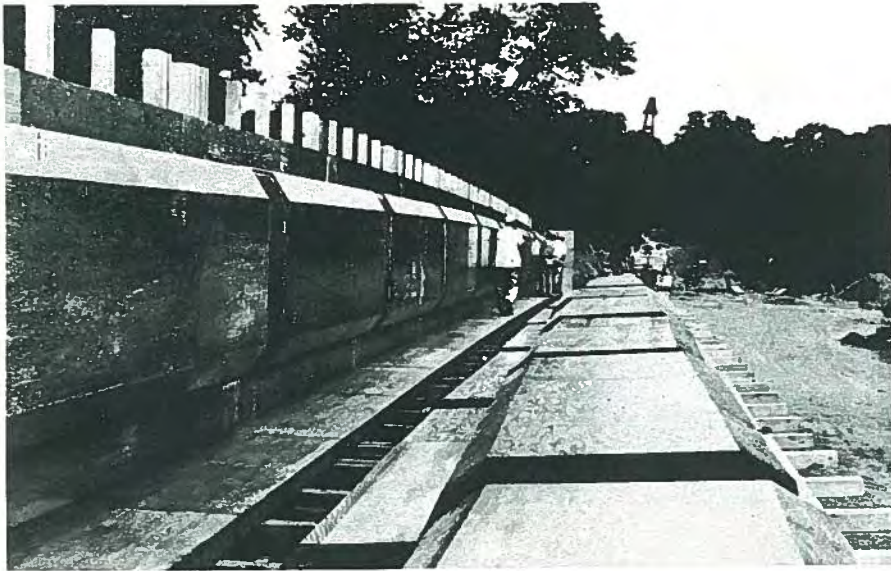

Fig. 1. Wood forms for Walnut Bridge.

ing** 3000-psi (20.7 kPa) concrete with a high slump of approximately 5 to 6 in. (127 to 152 mm) was duly impressed. [It must be appreciated, of course, that 30 years ago the requirement for a 5000-psi (34.5 kPa) concrete on a job site was extremely rare.]

Horst was obviously in a predicament. How was he going to comply with Magnel's requirement of no-slump concrete? On the one hand, he was aware that the professor was uncompromising where workmanship and quality were concerned. [Professor Magnel knew from rigorous laboratory experiments and long years of field experience that the component materials of prestressed concrete, i.e., steel and concrete, "work harder" (as compared to conventional reinforced concrete) under high stresses. Therefore, the quality of both

*How appropriate a term for what is usually done at the job site. However, one "pours" soup, not concrete. Quality concrete should be "placed."

†The concrete should have at least an ultimate strength of 5000 psi (34.5 kPa), consistently, and the cold drawn wires at least 220,000 psi (1517 kPa).

materials must meet relatively high strength and durability standards.†]

On the other hand, Horst knew that a batching plant at the site of his three-span structure, which could produce no-slump concrete, was impractical due to lack of storage space for raw materials and working space. To install a batching plant would also be too costly since only a relatively small amount of high strength concrete was needed.

An additional consideration was that Horst realized that if prestressed concrete, particularly post-tensioning at the site, was ever to get off the ground in the United States, he needed the cooperation of the ready-mixed concrete industry, which he would obviously receive by using ready-mixed concrete for this first structure.

Because of all the above considerations, Horst had no other choice but to use transit ready-mixed concrete for the Walnut Lane Bridge even though the haul from the concrete plant to the casting site was nearly an hour's drive. Horst realized fully well that he would not get "no-slump" concrete out of the mixer.

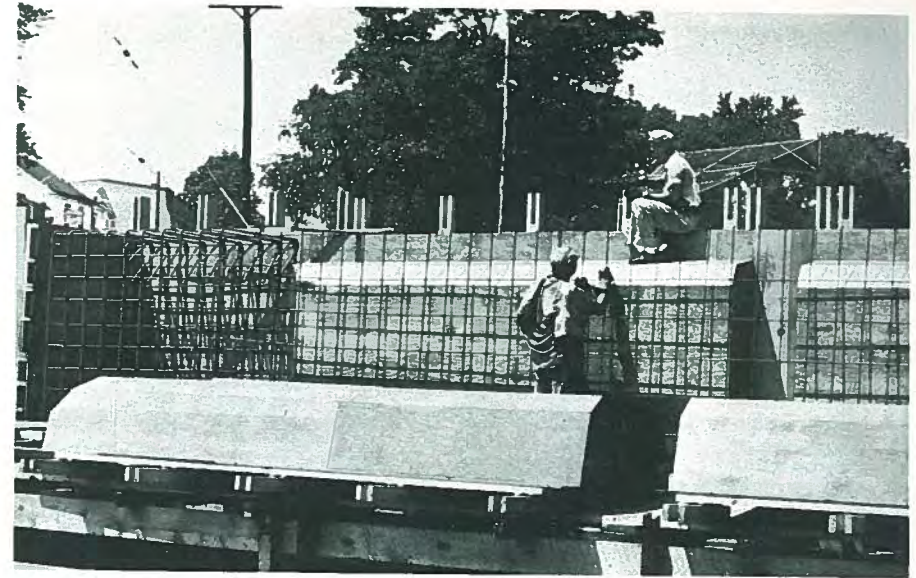

Fig. 2. Placing reinforcement in wood forms for Walnut Lane Bridge.

To make matters worse, Sam Baxter (at the afore-mentioned dinner) reminded Horst that in accordance with the contract, Professor Magnel had the last word. No approval from Professor Magnel meant no approval from the City of Philadelphia†† and the Professor demanded "no-slump" concrete!

Fortunately, Professor Magnel was also an eminently practical man. He understood the problem and eventually agreed to a *maximum* of 2-in. (51 mm) slump on condition "you are going to use steel forms so that, to insure compaction, you can vibrate the concrete *energetically* by means of external vibration . . . of course, you will do this in combination with internal vibration."

This modified provision was not well received by the Preload Corp. (fabricators of the concrete girders). But Professor Magnel was drawing on his long experience in prestressed concrete work. He had learned that with low slump, but high strength concrete for I-beams having relatively thin webs in relation to their depth (which makes placing of concrete difficult) energetic *exter-*

nal vibrating in addition to internal vibrating, was imperative.

This dual consolidation of the concrete is essential if honeycombs and/or cold joints are to be avoided. Such vibrating, with high frequency and relatively low amplitude vibrators could only be effectively done through the use of properly braced and stiffened heavy gauge steel forms to which vibrators could be attached, permanently or temporarily.

Preload Corp. had based their cost estimates on the use of two sets of wood forms (see Figs. 1 and 2) for the main span girders and another two sets for the approach span girders. They intended to place and internally vibrate the concrete through side windows which were to be located slightly above the bottom flange of the girder in each panel between 14 ft 6 in. (about 5 m) on center diaphragms.

††Quoting from Baxter's letter to A. W. Horst, June 17, 1949: "Since Professor Magnel was designated in the documents which accompanied the proposal, as the engineer who would be responsible for this work, I must insist that the procedures and methods adopted will have his approval."

The Author

Charles C. Zollman was instrumental in the promotion, development, design and construction of Philadelphia's Walnut Lane Bridge, the first major prestressed concrete bridge in North America. He was the first chairman of PCI's Technical Activities Committee from 1957 to 1960 and an active participant in PCI affairs as director from 1956 to 1959.

Mr. Zollman's early consulting services for the design and construction of pretensioning plants throughout the United States, his activities in the field of precast concrete as well as his many contributions to the PCI, have identified him as a pioneer of this industry in North America.

Mr. Zollman was a student of Professor Gustave Magnel at Ghent University, Belgium. Later, he became Magnel's unofficial representative in the United States, responsible for the detailed arrangements of Magnel's several trips to this continent.

In 1973, the Delaware County Chapter of the Pennsylvania Society of Professional Engineers named Mr. Zollman "Engineer of the Year." The honor was bestowed for his "Engineering Excellence in the design and administration of numerous large civil engineering projects; for his pioneering achievements in the design of prestressed concrete bridges and for his dedication as a teacher of the theory of prestressed concrete design."

Preload Corp. objected to the use of steel forms because their high costs could not be depreciated with only seven uses for each of the four forms.* Very reluctantly and against his better judgment, Professor Magnel resolved the impasse, by yielding to Preload's pressure. In doing so, however, he predicted there would be trouble and indeed there was!

Preload attempted to provide whatever external vibrating the wood forms could withstand without damage or displacement, hoping the less intense vibrating "would do the job nevertheless."

As Professor Magnel had anticipated, the abundance of concrete placing problems throughout the entire concreting job was caused primarily by insufficient external vibrating. Energetic vibrating would have caused misalignment of the forms and would have torn them apart after only two or three uses, requiring the purchase of additional forms. This method would have been most un-

*Seven uses for wood forms is very good, but is not sufficiently economical for steel forms.

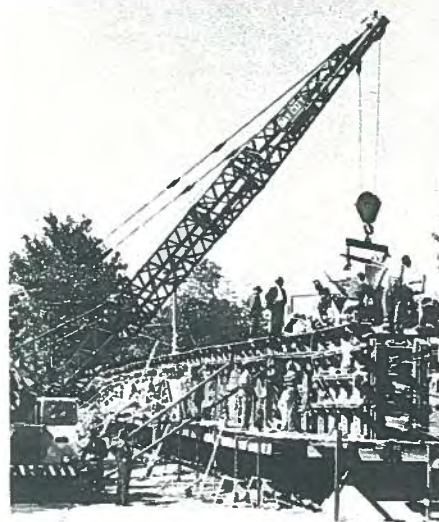

Fig. 3. Placing of concrete in Walnut Lane test girder.

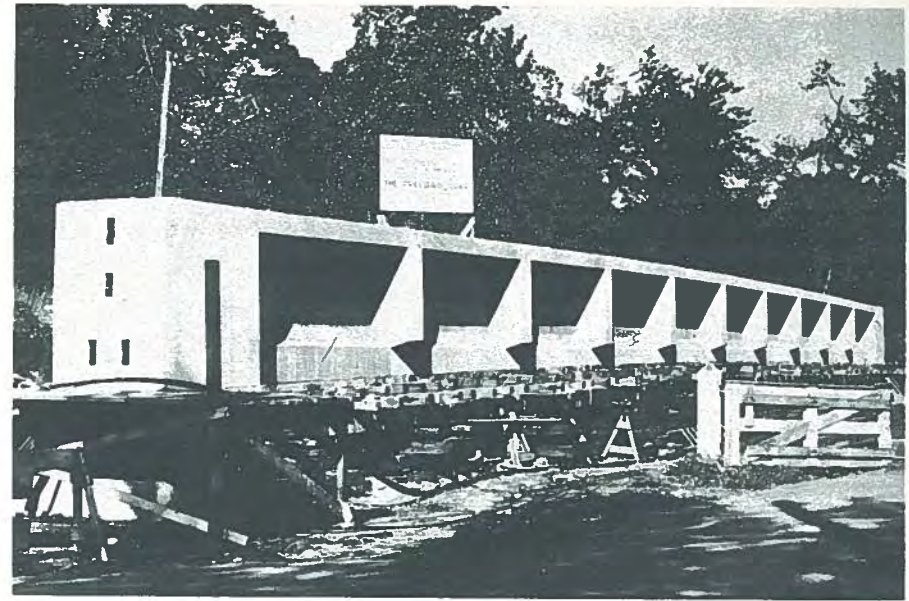

Fig. 4a. Appearance of Walnut Lane test girder.

economical. Even less intense vibration damaged the forms and maintenance became greater than anticipated with a corresponding increase in cost. If this additional expense had been considered initially, Preload could easily have afforded the use of steel forms.

It should be mentioned that the placing of 80 cu yds (61 m³) of concrete in the test girder (see Fig. 3) took a full day under the guidance and supervision of a Belgian technician experienced in prestressed concrete work. When the forms were stripped, the appearance of the finished test girder was perfect, as can be seen in Fig. 4a. However, after the technician departed for Belgium, the general contractors' workers, particularly their superintendent, had taken over placing the 80 cu yds (61 m³) of concrete in the first girder which was to become a part of the bridge.

The workers were very proud indeed when they had completed the job, including the vibrating, in about half the time it took to complete the test girder. But their pride and satisfaction did not last long.

When the forms were stripped, the sight was appalling: honeycombs throughout the girder, cold joints, displacement of wire units, and reinforcing steel wire were only too evident (see Fig. 4b).

Unfortunately, attention had not been



Fig. 4b. Appearance of first bridge girder cast (fascia girder).

paid to the instruction and advice given by the Belgian technician. Eventually, the general contractors learned how to fabricate a perfect girder, but at great expense and emotional grief. All this anguish could have been avoided if the contractors had only followed the good advice which they had paid for in the first place.

As is almost always the case when European construction methods have to be reconciled with American construction practices, many problems surfaced during the actual construction of the bridge. Fortunately, Samuel Baxter, Chief Engineer and Surveyor for the city of Philadelphia stayed on top of the job at all times. With the help of Max Barofsky, his assistant in charge of all field construction, differences were amicably resolved, one by one, at times by compromise, at other times with strong letters. The following is an extract from a letter Baxter wrote to the general contractor:

"The bridge is being built for the City, and is being paid for by the City. The contract requires that methods of procedures, schedules of work, and similar items are subject to the approval of the Engineer (Magnel). We have found that several such matters have been started without discussion or approval by us ... I am sure that you and Preload will understand the necessity of following the thoughts expressed in this letter and will act accordingly."*

Baxter felt, and rightly so, that because the Walnut Lane Bridge was an imaginative and significant design, pos-

*Letter from Baxter to Henry W. Horst, general contractor, October 15, 1949.

†Magnel used to tell the story of his visit to the site toward the end of construction. There he saw the last girder on its soffit waiting to be stressed. He asked the girder: "Tell me, my little friend, why are you not stressed?" And the girder would say, "Well, my dear professor, they put too much water in my concrete. I am still too weak and not strong enough to be stressed." And Magnel would shrug his shoulders ... and smile.

‡This latter method is what William E. Dean would advocate as discussed later on in this paper.

sibly opening up new opportunities for other designers and builders, everyone connected with the job would want to be credited and recognized on successful completion of the project. On the other hand, if there were any errors or misjudgments Baxter knew fully well that he alone would have to shoulder the blame.

Eventually, the bridge was completed to the satisfaction of all concerned, particularly the Philadelphia officials. The high standards of workmanship which Professor Magnel demanded were met, though completion of the Bridge went beyond the scheduled date. The concrete did not attain the required strength for prestressing transfer as early as was hoped for since the slump was gradually increased far beyond the agreed upon 2 in. (51 mm) to compensate for placing problems (Fig. 5).†

Sam Baxter later analyzed these problems. Addressing the First United States Conference on Prestressed Concrete held at the Massachusetts Institute of Technology, in August of 1951 (attended by over 600 representatives from all segments of the construction industry), he recalled:

"Specifications called for a 2-in. slump concrete (very dry compared with usual mixes in this country) and of a 5400-lb strength in 28 days. Placing a dry mix in an I-beam cross section is tough enough, but in this case, it had to be pushed through a 7-in. web filled in part with cable ducts for the prestressing wires. Large voids appeared in two of the early girders.

"As a result of requests from the field, slump was gradually increased to 2½, 3 and 3½ in. This made it easy to place the concrete but led to other difficulties. The 5400-lb strengths originally attained in 15 days now took the full 28 days. Girder production took twice as long, since prestressing could not be started until the concrete had attained the required strengths.

"Next time we will keep a 2-in. slump and find ways of placing it or else, widen the web intentionally in the design."‡

E. L. CONWELL & Co.
ESTABLISHED 1891
 ENGINEERS—CHEMISTS—INSPECTORS
 2024 ARCH STREET
 Philadelphia 3, Pa. October 19, 1949

Laboratory No. C 92628-E

28 DAY REPORT OF COMPRESSION TESTS OF 6" x 12" CONCRETE SPECIMENS

Taken at Walnut Lane Bridge, City of Philadelphia, Pa.
 Date Taken September 21, 1949 and tested October 19, 1949

MARK	LOCATION	PROPORTIONS	SLUMP (in.)	WATER-CEMENT RATIO (Gallons per Sack Cement)	STRENGTH IN COMPRESSION (Lbs. per sq. in.)
FRS #1	-	-	3"	-	5270
FRS #2	-	-	1½"	-	5640
					AV 5455

These specimens stored under job conditions

8½ sacks cement per cu. yd. concrete
 Plastiment added

COMMENTS

These specimens made by our representative at the site of the above project.

Reported to:
 D. J. Lixner c/o Preload Corp'n. (5)
 S. A. L.

Respectfully submitted,
 E. L. CONWELL & CO.
 A. S. Peiper, President

Fig. 5. Copy of original 28-day report of compression tests of concrete specimen. Note date (beginning of project) and the 3-in. slump!

Baxter's keen observation did not, however, end the controversy of "low slump" concrete. In 1954, Professor Magnel addressed a luncheon meeting of the Concrete Industry Board of New York City. He said:

"... I returned yesterday from the Northwest where I visited with my good friend, Arthur Anderson. And—ladies and gentlemen—Tacoma will become famous for a second time!

Because there I saw Anderson consistently making zero-slump concrete for his prestressed beams!

"So, don't tell me anymore that you cannot make zero slump concrete, because I have seen it with my own eyes. Of course, you must use what we call in Belgium an 'Eirich' mixer, in other words, a horizontal mixer. That is the only way that you will be able to make high strength concrete for prestressed work."

What caused this outburst (for Professor Magnel was angry) was that he had been taken to task by American contractors for a statement he had made regarding the inability or unwillingness of Americans to make high strength concrete. The controversy had gone far enough to be published in the influential *Engineering News Record* with the headline: " 'Americans make soup, not concrete,' says Belgian Professor."*

Today, manufacturers of concrete mixers to be used in prestressing plants produce only one type of mixer, namely, the horizontal mixer!

In retrospect then, a major lesson Walnut Lane Bridge taught us was that steel forms and external vibration are prerequisites if sound and economical prestressed concrete products are to be produced. This has been recognized by the pretensioning industry which today uses almost exclusively, steel forms and external vibration.

Stress-Relieved Wire

Still another major benefit directly attributable to the Walnut Lane Bridge is the American improvement in the manufacture of cold drawn steel wire and the subsequent manufacture of strands using such wires. This development played a decisive role in the future growth of the prestressed concrete industry not only in North America but around the world.

During World War II, when Professor Magnel conducted laboratory tests on the phenomenon of creep, he discovered that the stress losses in the wires, due to creep, were too high at high working stresses. These losses had to be re-

**Engineering News-Record*, February 25, 1954, p. 23.

†Unfortunately, John A. Roebling & Sons Co., was unable to capitalize or generate sufficient compensation for its tremendous research and development efforts, much less financial gain. Other wire producers who did not have these costs to depreciate, entered the market shortly after this development, and contributed to the firm's demise.

duced. Further research showed that he could overstress the design working stress by about 10 percent, keep it at that level for about 2 minutes, and slowly reduce the jacking pressure until the design stresses were reached. This, in fact, is what American engineers would later call "stress relieving."

Unfortunately, Professor Magnel's original method of stress relieving was cumbersome, time consuming and not always reliable because labor had to be relied upon with constant supervision, all of which was very costly.

Charles Sunderland, then chief engineer for John A. Roebling & Sons, Co., believed very strongly he could improve upon Magnel's method. In his opinion, the desired results claimed by Magnel were not achieved. Sunderland was convinced that only 2 minutes of overstressing were not enough and that stress relieving belonged in the mill, rather than at the job site. Spurred by this challenge, he developed a unique manufacturing technique for stress relieving wire. Eventually he was able to furnish the site, and later the pretensioning plants, with a stress-relieved wire far superior in characteristics than any other prestressing wire produced in the world.

Roebing & Sons were the first to produce a wire for the prestressing industry which had a higher ultimate strength, less creep and other improved properties, allowing for higher working stresses.†

Stress-relieved wire was a significant contribution to prestressing. In a short time, it became the only type of wire used world-wide for prestressed concrete. Until that time, the European wire manufacturers were selling cold drawn wires "as drawn" not realizing (or perhaps unwilling to admit) the necessity of reducing steel creep in prestressed concrete and the importance of stress relieving at the mill.

One of the major reasons the test girders for the Walnut Lane Bridge per-

Lessons from Galipault Bridge

Although the lessons learned (namely, the necessity to place the fresh concrete in steel forms and to use external vibration) from the Walnut Lane Bridge were widely known and documented, some people, apparently, never learn from the experience of others.

A case in point was the construction of the Galipault Bridge in Canada which I investigated in 1963 on behalf of the contractor.

Hair cracks, honeycombs, dis-

placement of prestressing wire units, unwarranted sweep, cold joints and other deficiencies caused the rejection of 38 (yes indeed 38) 100-ft (30.5 m) long by 72-in. (1.9 m) deep girders.

Cause of the deficiencies: distortion of wood forms due to energetic external vibration. In addition, the thin cross section of the deep girders made concrete placing extremely difficult (see Figs. 6a and 6b).

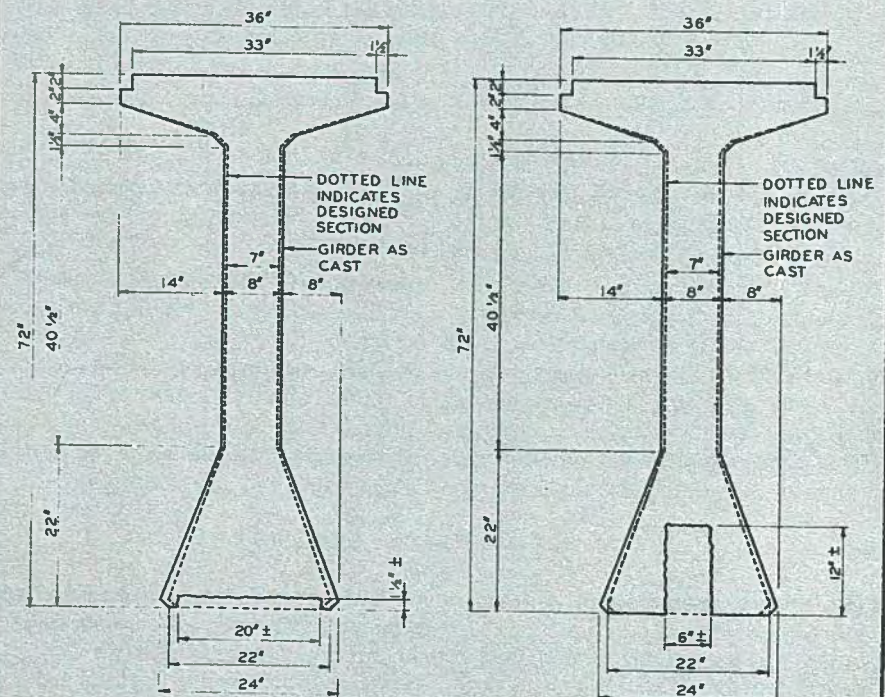

Fig. 6a. Cross section of oversized girder with spalled soffit.

Fig. 6b. Cross section of oversized girder with tendons not completely surrounded by concrete.

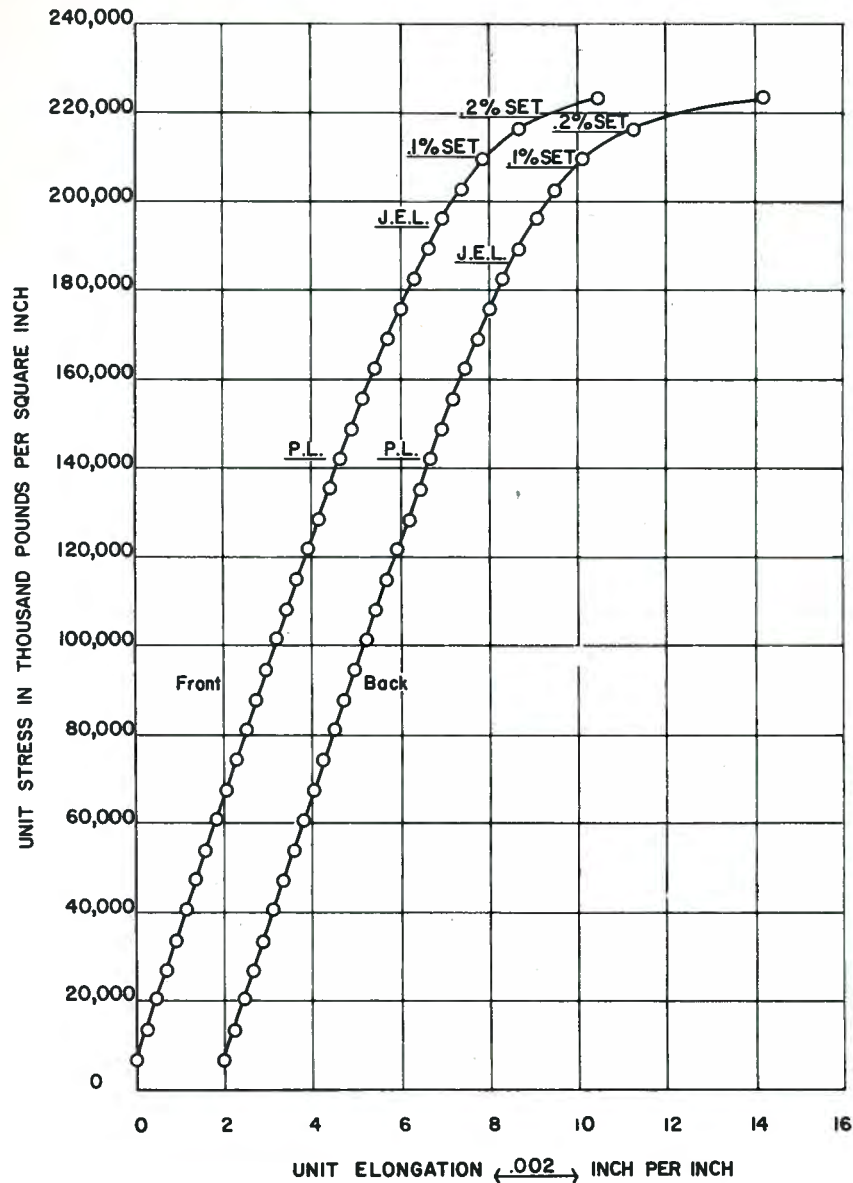

Fig. 7. Stress-strain diagram of Roebling's stress-relieved wire as used for Walnut Lane Bridge. (Note: Tensile test on 0.276-in. diameter high elastic limit wire; coil No. 28; 80D stock; Heat 2: 5068; from 10,000 lb production lot for Preload Corp.; June 16, 1949.)

formed so well was the use of American-made wire with improved characteristics (see Fig. 7). These girders

originally were designed for the European-made wire having less desirable creep characteristics.

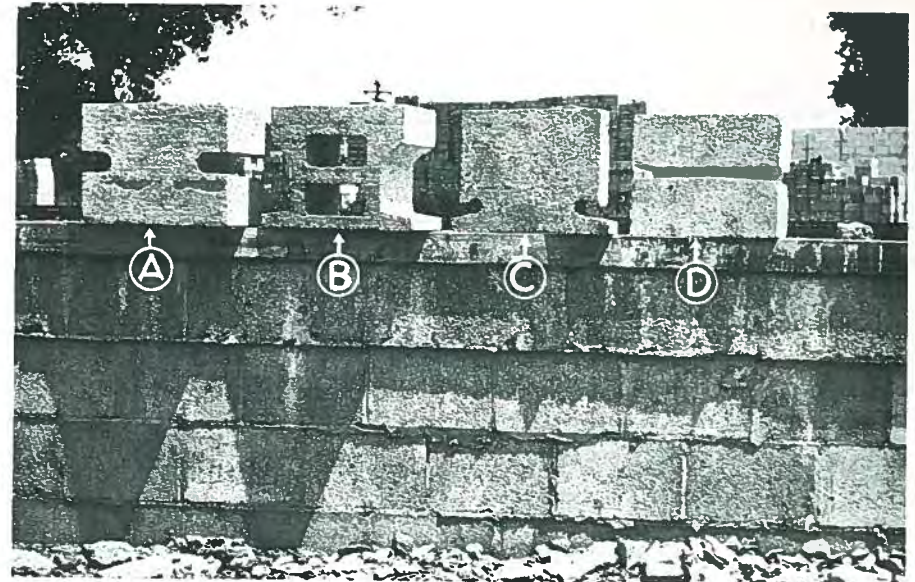

Fig. 8. Typical machine made concrete blocks as used by Ross Bryan for block beams. Block A: terminal end block at live end of beam; Block B: Standard unit; Block C: Positioning block; Block D: Special grooved end block at dead end of beam.

Prestressing Machine-Made Concrete Blocks

Totally independent of the events surrounding the Walnut Lane Bridge, Ross Bryan, consulting engineer in Nashville, Tennessee, conceived the idea of prestressing machine-made concrete blocks (see Fig. 8).¹ This was accomplished with the aid of factory-made stressing units such as Roebling's

stranded galvanized cables and fittings as shown in Figs. 9a and 9b.² Prefabrication would keep site work to a minimum and hence, lower costs.

Block A in Fig. 8 is the typical live end terminal unit. Block B is a standard unit; Block C, the positioning unit, and Block D, the special end block unit having grooves in the two side faces and in the end face. The construction procedure was then to anchor the tensioning cable with standard fittings in the terminal end

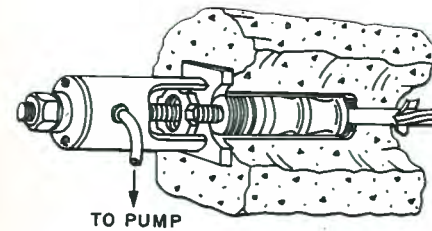

Fig. 9a. Typical Roebling anchorage (before stressing).

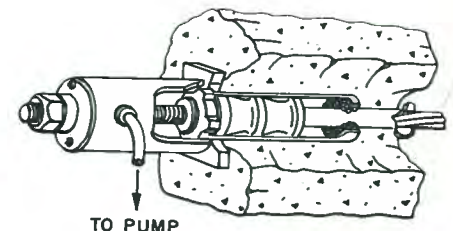

Fig. 9b. Typical Roebling anchorage (after stressing).



Fig. 10a. Erection of block-beams hauled 176 miles from fabricating plant to erection site, Obion County, Tennessee (about 1950).

unit; to place the cable in the recess outside the line-up standard units; and to wrap the cable around the special end unit, thereby eliminating two end fittings at one end of the beam thus formed.

Tennessee's Highway Department erected beams made this way for spans up to 50 ft (15 m) for secondary road bridges (Figs. 10a and 10b). After placing the beams side by side, concrete

was cast between them which embedded and bonded the stressing units.

A cast-in-place concrete wearing surface would complete the structure erected with a minimum of skilled field labor.

C. L. Johnson, partner in the consulting engineering firm of Johnson and Anderson, Pontiac, Michigan, approached the same problem in a slightly different



Fig. 10b. Completed three-span block-beam bridge in Tennessee.

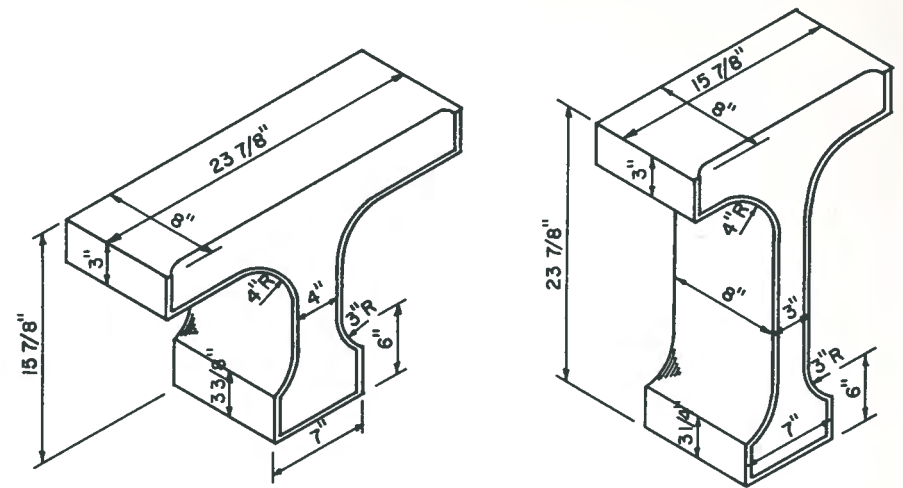

Fig. 11. Typical machine made blocks as used in Michigan area. Only three kinds of blocks are required to make up a Michigan block-beam.

manner. Typical I-shaped blocks as shown in Fig. 11, were stamped out on a Besser machine in a block plant. At the left of Fig. 12, the position block is shown; at the center is the typical block and at the right, the end block.

Of particular interest are the joints (see Figs. 11 and 12) which are poured instead of butted, with a rich grout in its small lip or bead cast around the edge of one race of the block. Better control of the total length of the girder was insured.



Fig. 12. Typical Michigan area blocks as produced by Besser machine.

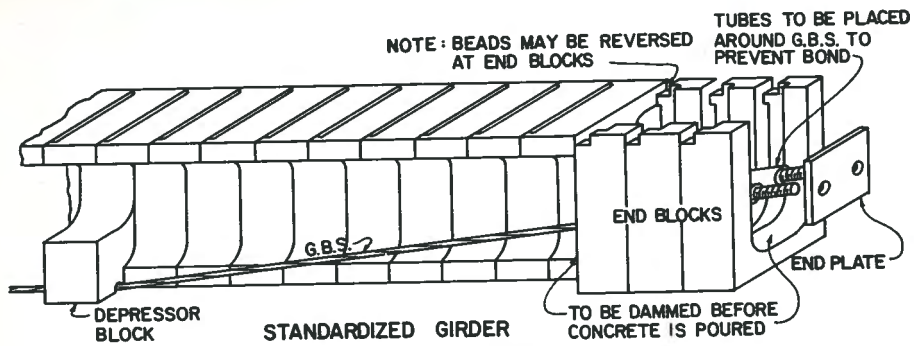

Fig. 13. Michigan block-beam as made up before stressing.

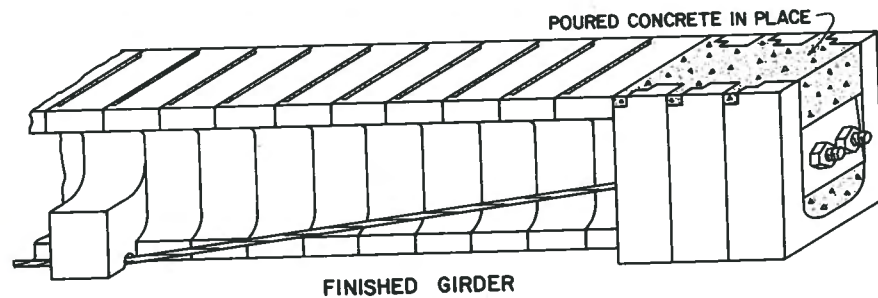

Fig. 14. Michigan block-beam as made up after stressing.

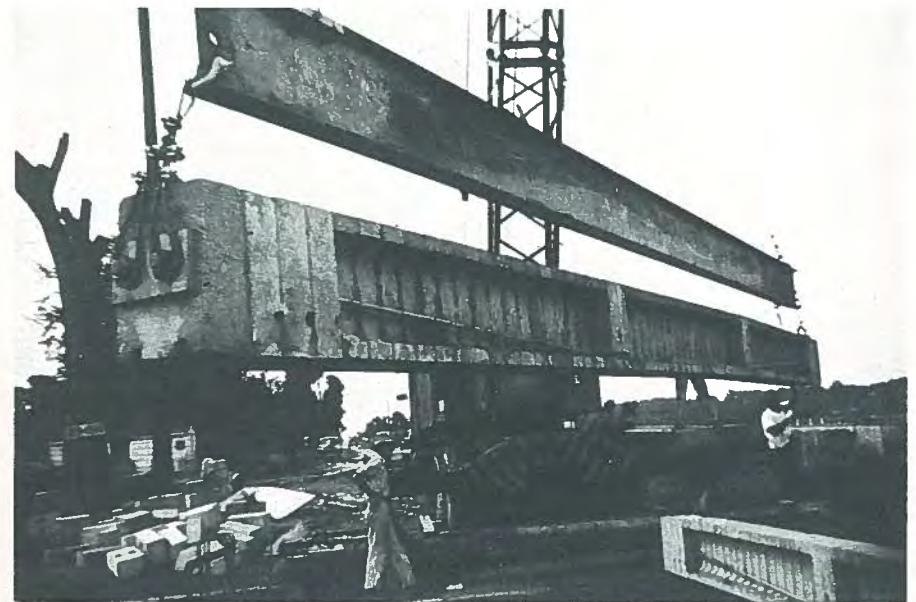

Fig. 15. Testing of Michigan block-beam with 1.5 live load.



Fig. 16a (top). Erection of typical block-beam in Michigan.

Fig. 16b (bottom). Close-up of block-beam during erection showing post-tensioning wire unit.



It was also speedier and more economical than a troweled mortar joint, performed by unskilled labor. Fig. 13 is a line drawing of a girder assembled while Fig. 14 shows a completed girder. Fig.

15 illustrates a load test and Figs. 16a and 16b show the erection of such a block-beam.

However, with the advent of the pre-tensioning plant and the stranded ten-

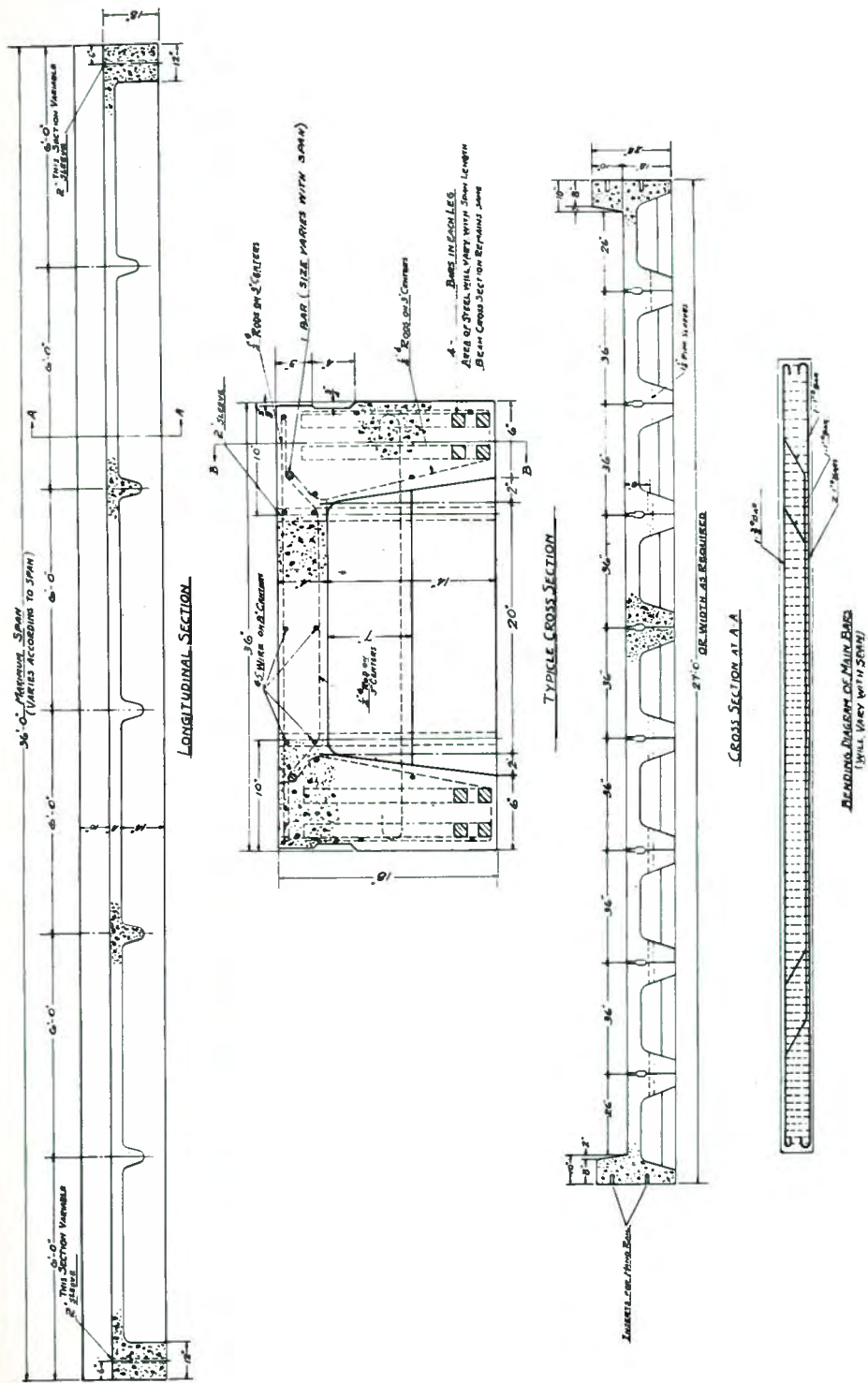

Fig. 17. Typical precast concrete channel slab as used around 1950 in Pennsylvania.

dons (as will be explained further in this article), the prestressing of factory-made concrete blocks fell into disuse and was eventually replaced with the more economical Florida-developed double tees and California-developed single tee panels which have a greater load capacity with greater span possibilities and more versatility.

The concrete block development is mentioned here for its historical interest, for the skill, ingenuity and talent shown by Ross Bryan and C. L. Johnson who had a pioneering spirit of their own.

It should be recognized that while Bryan's bridge was the first prestressed bridge completed in the United States, it was a *block bridge* for secondary roads, while the Walnut Lane Bridge was the first large *girder* type bridge on a main city parkway. Thus, both bridges could be considered as firsts in their own right.

In passing, it should also be mentioned that Ross Bryan played a major role in getting some of the early prestressing plants started.

Plant Produced Prestensioned Members

Among the members of the group who travelled to Europe with Sam Baxter in May, 1949, were Robert Petersen and Ben Baskin, president and chief engineer, respectively, of the Concrete Products Co. of America, Pottstown, Pennsylvania (about 35 miles northwest of Philadelphia). Officially, they went along for the "ride," but in reality, they had a serious problem on their minds and hoped to find the answer in Europe.

As astute businessmen, they kept the problem to themselves. But first, a little background. In 1947, Concrete Products began producing, under controlled conditions and rigid state inspections, precast concrete channel slabs (Fig. 17) for secondary bridges for Pennsylvania's State Highway Department. The spans, however, were limited to about 36 ft (11

m), primarily because deflections became excessive beyond that span length for highway truck loadings and also because of lack of transverse rigidity of channel slabs. Petersen and Baskin realized that if they were to survive in a competitive market, they had to extend the spans to 50 ft (15 m) at least, and if possible, beyond that.

They found their answer in Great Britain while visiting a prestressing plant near London. Here they observed the precasting of small products (such as building joists, planks) using 2 mm (0.076 in.) diameter piano wires—"toys" as Professor Magnel would say. Magnel always thought in terms of large structural members having to carry heavy loads.

After this visit to the British plant, Petersen and Baskin were convinced that plant-produced prestensioned beams (as opposed to the post-tensioned beams Freyssinet and Magnel were advocating) were the answer to their specific problem. This was the "answer" provided, of course, they could practically and economically resolve three major foreseeable problems, namely:

1. Rigidity of the member
2. A suitable anchorage system
3. An efficient prestressing wire

1. Theoretically, the first problem could easily be resolved by adding a bottom slab to the legs of the channel (Figs. 18a and 18b) so as to shape a monolithic cross section (Fig. 18c). A box-like beam having the required stiffness and transverse stability was obtained and, thus, the problem of rigidity could be solved.

But how would they form the inside faces of the box? At that stage of development, they could not find the answer. They decided, therefore, to use cardboard sonotubes and the cross sections shown in Figs. 19a and 19b resulted.

The former section (Fig. 19a) was capable of carrying H20-S16 truck loads

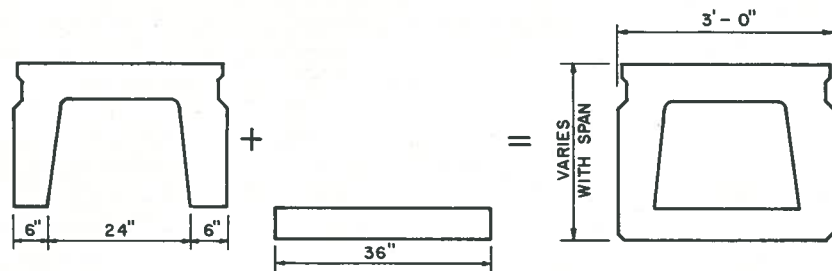

(a) Channel Slab + (b) Bottom Slab = (c) Box Girder

Fig. 18. Logical development from channel slab into box girder.

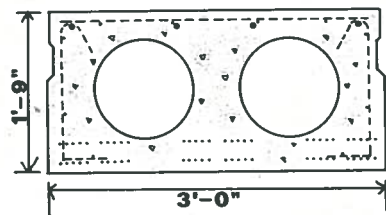

Note: This section is used for members having clear spans from 18 to 36 ft; for spans from 18 to 28 ft the depth is 17 in. and the diameter of the holes is 10.5 in. For clear spans from 30 to 36 ft the depth of the members is 21 in. and the holes, which extend to within 2 ft of the ends, are 12.5 in. The width of all members is 3 ft. The number of steel cables, 0.25 in. in diameter, ranges from 27 to 76 for clear spans from 18 to 36 ft.

Fig. 19a. First design of box girders for short spans using sonovoids (1950).

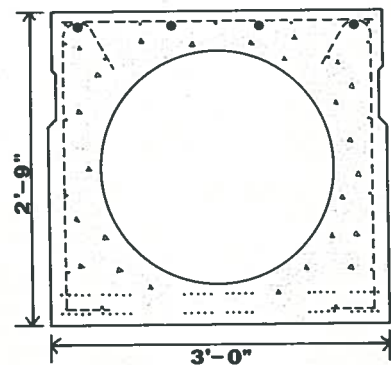

Note: This cross section is for pretensioned prestressed concrete bridge members, for clear spans from 38 to 50 ft. The number of steel cables, each 0.25 in. in diameter, ranges from 48 to 80—depending on the span. The width of all the members is 3 ft and the depth is 33 in. The diameter of the hole, which extends to within 2 ft of the ends of each member, is 24.75 in.

Fig. 19b. First design of box girders for long spans using sonovoids (1950).

for spans from 18 to 36 ft (5.5 to 11 m), the latter (Fig. 19b) for spans ranging from 38 to 50 ft (11.6 to 15.2 m). The standard width for both was 3 ft (0.91 m). The depths were 17, 21, or 33 in. (432, 533, or 838 mm) depending on the span. The cost of forming was reduced to a minimum, being limited to exterior side forms.

Concrete Products eventually found an elegant solution to their "inside forming" riddle. The procedure Ben Baskin devised was simple and ingenious,³ as we all know today. However, for several years, it remained a closely guarded secret. At that time, Concrete Products' competitors could not fathom how it was done. Of course, the "secret" eventually leaked out and the box girder became, and still is today, a very popular, useful and practical pretensioned product employed throughout North

America and elsewhere. Further refinements allowed spans to be increased to 100 ft (30.5 m) and even beyond, with transportation and erection remaining as the only problems to be solved.⁴

2. The next problem was to find an economical, temporary anchorage to hold the stressed wire to the stressing bed. Ben Baskin was able to produce an inexpensive sleeve-type device which could be swaged readily onto the wire holding the stress induced in the wire. This device was to be the forerunner to the strandwise now used universally throughout the industry.

3. The last problem was the most difficult one to solve. It was not practically feasible to use a great number of piano wires to take care of the large prestressing forces required by the superimposed loads produced by the heavy AASHTO (today's AASHTO) truck loadings. Unfortunately, the use of larger diameter single wires was not a viable solution because bond requirements could not be satisfied with such wires. In desperation, Ben Baskin turned to Walter O. Everling, Chief of Research for United States Steel. Prodded by Baskin, Everling came up with the stranded seven wire unit!

Bond tests were subsequently conducted on the 1/4-in. (6.35 mm) diameter strand (made up of seven smaller wires) and these were, indeed, successful. Baskin then built the first pretensioned bed in North America, between 1949 and 1950. The bed length was 120 ft (36.57 m). During the spring of 1950, he produced the first American *pretensioned* bridge beam having a span length of 30 ft (9.14 m), a width of 3 ft (0.914 m) and a depth of 17 in. (432 mm), on his new stressing bed.

The beam was successfully tested to destruction at the plant in Pottstown, Pennsylvania, on May 20, 1950, in the presence of many State and City Public Works officials. The testing was done under the direction and supervision of

Dr. Arthur R. Anderson* who later built his own plant in Tacoma, Washington.

The successful load testing of this beam was a tremendous, innovative achievement. This development set an example which put into motion the forthcoming pretensioning industry.

It was not long after the casting of the first pretensioned box beam sponsored by Pennsylvania's Dept. of Highways, that an elaborate testing program on full-sized box beams was initiated at Fritz Engineering Laboratory, Lehigh University, Bethlehem, Pennsylvania. Under the direction of Dr. Carl Ekberg, Professor at the Civil Engineering School and Professor William J. Eney, director of the Fritz Engineering Laboratory, and head of the Department of Civil Engineering and Mechanics, the program was to last for several years. From this test program numerous test reports and papers were published which provided an extremely valuable source of reference material.⁵

As a direct result of these tests and their publication, in 1955 the Pennsylvania Department of Highways approved the use of prestressed box girders for six bridges over the Vine Street Expressway in downtown Philadelphia. This project was the first large-scale application of box girders in the United States. A total of 570 girders were required. Of these 553 were 48 ft long (14.63 m) (Fig. 20a), 26 were 60 ft long (18.3 m). Some of them (Fig. 20b) required up to 94 - 3/8-in. (2400 mm) diameter strands producing an initial prestressing force of 1128 kips (5020 kN). This was a tremendously large pretensioning force to cope with in 1955.

In summary, then, to Concrete Products of America** goes the credit for having built the first pretensioned bed,

*In addition to his many other accomplishments, Dr. Arthur R. Anderson was responsible for the instrumentation on the Walnut Lane Bridge test girder.

**In the early 1960s, about the time both Petersen and Baskin retired, the plant was sold to the American Marietta Corporation.

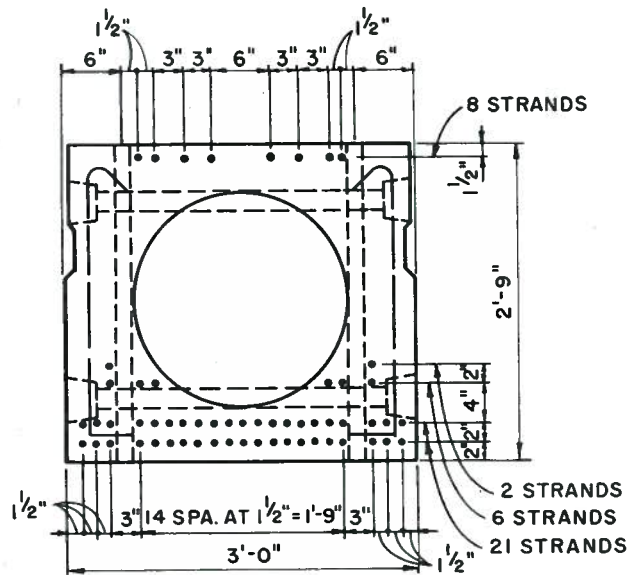

Fig. 20a. One of box girders for Vine Street Expressway in Philadelphia with fifty-eight $\frac{3}{8}$ -in. diameter strands with force of 698 kips (1955).

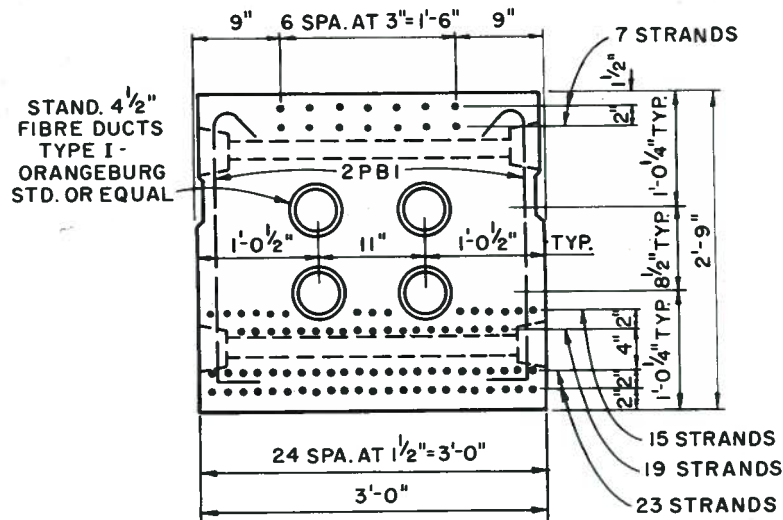

Fig. 20b. One of box girders for Vine Street Expressway in Philadelphia with ninety-four $\frac{3}{8}$ -in. diameter strands with force of 1128 kips! (1955).

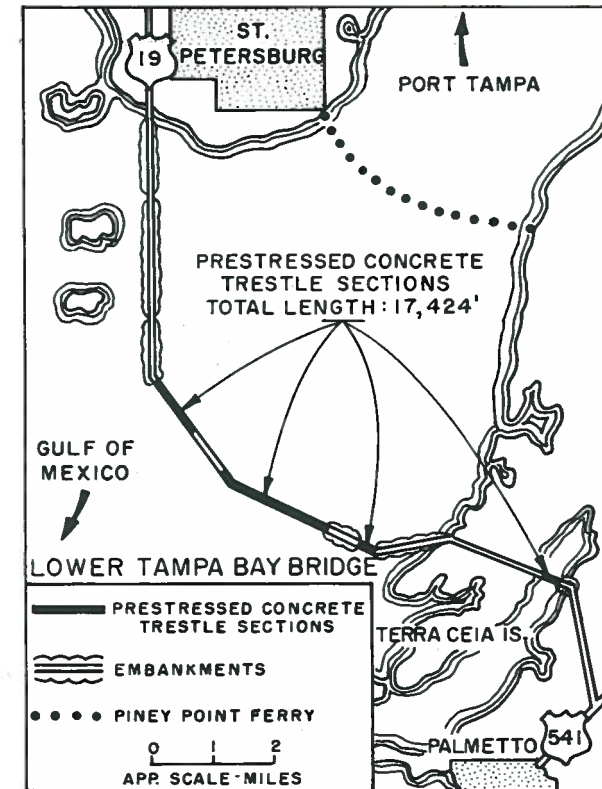

Fig. 21. Location map of Lower Tampa Bay Bridge.

for having produced the first box girder as a logical extension of their precast channel slab and for having been the driving force behind the development of the stranded wire. This important innovation was to become the basic element which made the pretensioning industry possible, practical and economical in North America.

William Dean's Influence

During the early construction stages of the Walnut Lane Bridge, the Preload Corp. learned of the revived plans by Florida's State Highway Department in Tallahassee, to construct the proposed Lower Tampa Bay crossing later to be

known as the Sunshine Skyway. This crossing connects the city of Brandon to St. Petersburg, Florida (Fig. 21).

This project had laid dormant for several years since bids taken around 1946 exceeded the allocated budget. The proposal was to construct a 17,500 ft (5334 m) trestle bridge calling for precast reinforced concrete units (Fig. 22) having spans of 36 ft (11 m) and a total width, out-to-out, of 37 ft 5 in. (11.4 m), including curbs (see next page).

Preload surmised that in using prestressed concrete, the 36 ft (11 m) span could, perhaps, be increased to 48 ft (14.63 m) without appreciable increases in concrete quantities for the superstructure. At first sight it appeared (and the actual construction later confirmed that assumption) that substantial

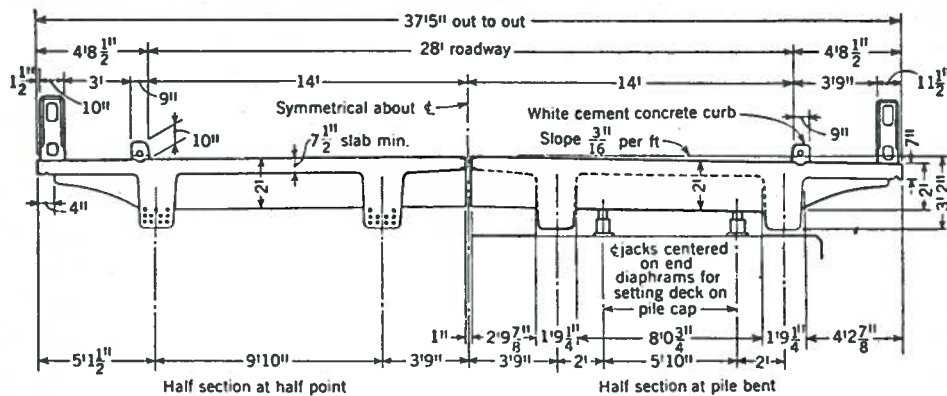

Fig. 22. The original precast reinforced concrete trestle for the Lower Tampa Bay Bridge consists of a precast deck divided along center line into two identical sections. The deck is erected on four-pile precast concrete bents spaced 36 ft on centers. For contrast see Fig. 25.

savings could be achieved in the sub-structure of the entire structure. If a prestressed concrete design were used, only three pier bents would be required to span the 144 ft (44 m) distance between tower bents whereas four pier bents would be needed for the precast design. This scheme would save one pier every 144 ft (44 m) in approximately 17,500 ft (5334 m) of trestle.

Ed Thwaits, Preload's Vice-President and sales manager, and I arranged to meet with William Dean,* Chief Bridge Engineer for Florida's Highway Department, to explore the possibilities of a prestressed concrete design substitution. Preload would cover all design costs but then could hopefully collect subsequent earnings produced from anchorage royalties.

We were all exuberant with high hopes and expectations [after all, how often do you have 17,500 ft (5334 m) of

*William Ennes Dean was born on November 15, 1909, and died December 30, 1965. He retired from the Florida State Road Department in 1962 after 30 years of distinguished service.

†The Sclayn Bridge has two 205-ft (62.5 m) spans with a maximum depth at each midspan of not more than 6 ft 8 in. (2 m).

repetitious and identical spans?] Ed Thwaits and I left on a Sunday night in April 1950 for Tallahassee to keep the Monday morning appointment.

The reception we received, while very polite, was cold indeed. Bill Dean's comment, "I have gone sour on prestressed concrete," put us into a state of shock. Fortunately, Ed Thwaits kept very calm. Always the suave and smooth diplomat, he replied: "We are very sorry that you feel that way and, I guess, there is not much that we can do about it. However, since we are here, perhaps you would like to look at some photographs we have on the construction of the Walnut Lane Bridge."

Being the congenial Southerner, Dean could not very well turn us down. Indeed, we had come all the way from New York. We proceeded to show him, and to elaborate on, the photographs. Dean, through his questions, appeared to warm up to the subject as we progressed with the photographs. At what we thought was the opportune moment, Thwaits mentioned to Dean that we had brought a short film on the construction of the Sclayn Bridge in Belgium,† the first continuous prestressed concrete bridge

to be built in addition to being the longest. Would he and his staff be interested in seeing it?

Dean's face brightened. "It so happens that tonight the local ASCE chapter holds its monthly meeting at the Naval Base, and we do not have a speaker. Perhaps, Mr. Zollman would care to be the speaker, talk about the Walnut Lane Bridge and show the film."

We not only jumped at the chance but also offered to take care of the refreshments for the "happy hour" which usually followed such meetings.

The evening was a memorable one and in retrospect I believe it proved to be decisive in swinging Bill Dean over to the proposed prestressed bridge.

During the evening, beginning with a sociable dinner attended by Dean, his principal assistant, Tom Jennings, Ed Thwaits and myself, an atmosphere of mutual trust, respect and confidence developed. These mutual feelings, despite the diverse background of the participants, were to last until Bill Dean's untimely death at the relatively young age of 57.

It was during this dinner that Dean, who had the highest regard for Hardy Cross (the greatest American engineer in Dean's opinion) discovered that I had been a student of Cross's.* Well, that did it! My "stock" went up sky-high with Dean and with it, the prospects for the prestressed design.

I believe that the technical presentation I made at the local ASCE meeting was well received (Fig. 24) as were the refreshments. Dean was the hero of the evening. Not only had he saved the day by finding a speaker on such short notice but he found one that provided refreshments for a meeting expected to be dull. Instead, the evening was most congenial and successful (no mean feat in a dry county!)

Tampa Bay Crossing

The day following the meeting, Thwaits and I faced another Dean, this

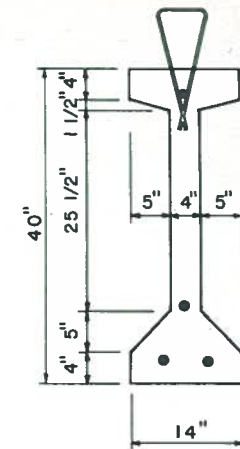

Fig. 23. Cross section of Tampa Bay beam as designed by the author while staying in a Tallahassee hotel. The beams were later cast in a yard near the bridge site.

time, cordial, smiling and in excellent spirits. The subject of the bridge was discussed and Thwaits suggested that I could develop (while in Tallahassee) a preliminary design and analysis for a typical span of his bridge—and roughly estimate the cost for such a structure. For the balance of that day and evening I worked in my Tallahassee hotel room with a pocket-sized slide rule,† to determine an economical span and an acceptable I-beam cross section.

The next day, we submitted our suggested I-beam design (Fig. 23) to Dean together with our supporting computations. Dean seemed to be satisfied. He did not find anything wrong on a quick check but asked whether he could keep the computations. I gave him the originals (there were no Xerox machines

*This incident is mentioned here only because one never knows how an incidental remark can greatly influence a serious decision-making process!

†Magne's philosophy was that in view of the many assumptions an engineer has to make, the accuracy obtained in using a pocket-sized slide rule was more than enough—if an engineer thought he needed a full-sized slide rule, he was not much of an engineer. Naturally, Magne always used a pocket-sized slide rule.

MEMBERS:
 ALFRED A. MCKETHAN
 BROOKSVILLE, FLA.
 J. GLOVER TAYLOR
 JACKSONVILLE, FLA.
 MARION G. NELSON
 PANAMA CITY, FLA.
 MERRILL P. BARBER
 SEBO BEACH, FLA.
 TRUSTEN P. DRAKE JR.
 OCALA, FLA.

STATE ROAD DEPARTMENT OF FLORIDA
 TALLAHASSEE
 April 12, 1950

Mr. E. H. Thwaits
 Vice President
 The Preload Corporation
 211 East 37th Street
 New York, 16, N. Y.

Dear Mr. Thwaits:

The Navy Reserve personnel and all of our Engineer guests enjoyed and appreciated the program which you and Mr. Zollman presented on your last trip to Tallahassee. All persons who were privileged to see and hear it have expressed a desire to be present at another program along the same lines and on the same subject.

Captain James D. Wilson, District Civil Engineer for the Sixth Naval District has stated that he will make every effort to be present at any future programs we arrange and sponsor which are as essential to the progress of construction and engineering as the one which you presented to us. I am convinced that the Navy Civil Engineer Corp will welcome the opportunity to sponsor your program wherever they have a Regular or Reserve Organization.

Mr. Dean has advised me that you and Mr. Zollman will probably be in Tallahassee sometime during the month of May, 1950. If you wish to put on another program at that time we will be glad to sponsor it and make the necessary arrangements for advertising and for a place to accommodate the turnout we could have. It is expected that we could have approximately sixty engineers and construction men present, if given time to do the necessary advertising.

With two weeks notice we can schedule the program on a date to suit your convenience.

Yours truly,
R. E. Arnow
 R. E. Arnow

cc: Captain James D. Wilson
 Dist. Civil Engineer
 APR 15 1950

Fig. 24. Letter concerning presentation at Naval Base, Tallahassee, April 1950.

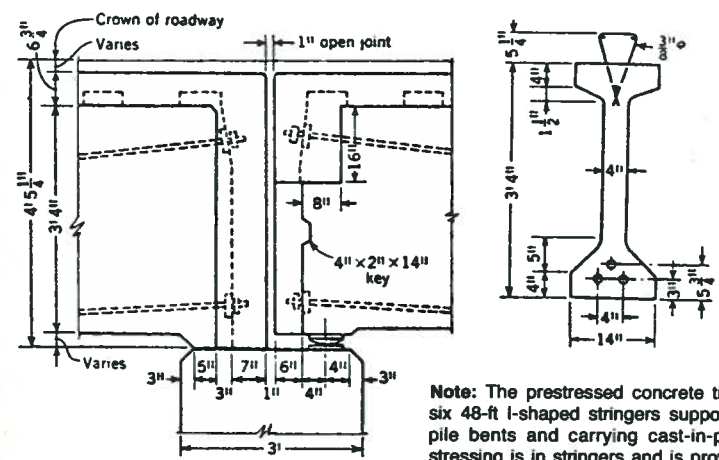
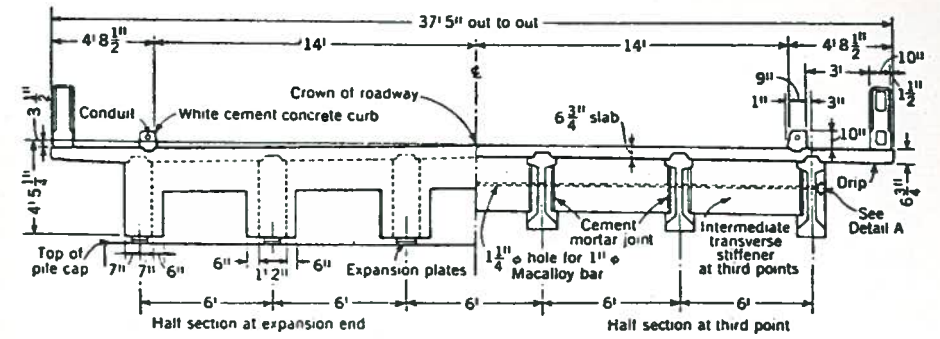

Note: The prestressed concrete trestle consists of six 48-ft I-shaped stringers supported on concrete pile bents and carrying cast-in-place deck. Prestressing is in stringers and is provided by three 1-in.-diameter British-made Macalloy bars.

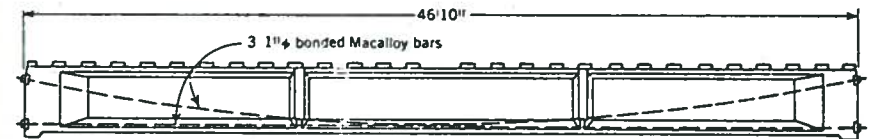

Fig. 25. Typical cross sections of prestressed concrete superstructure and elevation of prestressed beam for Tampa Bay Bridge (for contrast see Fig. 22). Note that this was the first use of the Lee-McCall system of prestressing in the United States.

in those days!) and returned to New York puzzled and wondering what the next step would be. Two days later, the mail brought us not only the computations I had made but additional computations for deflections, camber, cracking load, ultimate load (the whole bit) in Dean's handwriting on standard yellow paper.

Apparently, Dean had convinced him-

self that prestressing was a sound concept after all and had kept the door open for further discussions. Many meetings followed between Dean and the consultants to the State of Florida, namely, Parsons, Brinckerhoff, Hall & MacDonald.* These meetings resulted in the bridge cross sections shown in Fig. 25.

*Now known as Parsons, Brinckerhoff, Quade and Douglas.

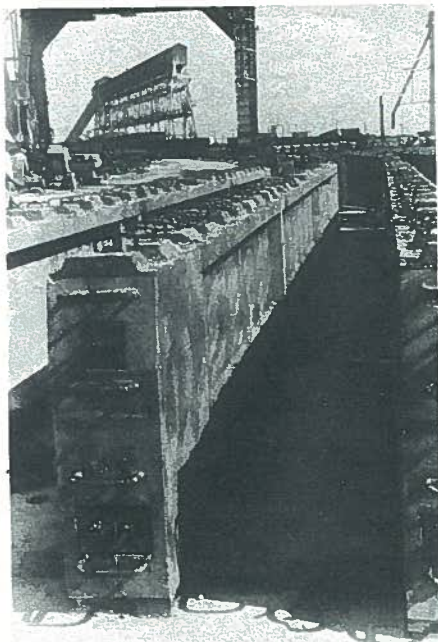

Fig. 26. Typical Tampa Bay beam in storage yard.

For Bill Dean it was a momentous decision, the effect of which was to be felt for many years throughout the entire construction industry. And why did he make that decision? After all, as a civil servant of the State of Florida there was no immediate nor long-range monetary return to be expected. All he could expect was criticism from entrenched vested interests in other construction materials and construction problems galore since, except for the Walnut Lane Bridge, there was no other structure of the magnitude of the proposed trestle. He was not disappointed in either. But it did not faze him as he was, if not somewhat conceited, certainly a competent and above all a fearless engineer who had the courage to base his decision solely on the merits of the material. There could not have been any other justification.

Eventually, contract documents were

*Forerunner of the Stressteel bars.

developed and completed for a prestressed design much like the one I had developed that day in the hotel in Tallahassee. The difference was that the Lee-McCall bar and anchorage stressing units* were used instead of the Blaton-Magnel system. (Preload had acquired patent rights for both systems.) Bids were taken in 1951 for the Tampa Bay Crossing and included a rather elaborate program for the testing of full-sized members.

The construction of that bridge crossing sustained the momentum initiated by the Walnut Lane Bridge and is described in detail by Maurice N. Quade of Parsons, Brinckerhoff, Hall & MacDonald in his paper "15 Mile Toll Bridge Under Construction Across Lower Tampa Bay," appearing in ASCE's *Civil Engineering*.^{6,7}

"Tests Establish Construction Procedures for Prestressed Beams in Tampa Bay Bridge," written by Dean appeared in a following issue of *Civil Engineering*.⁸ (Fig. 26 shows a beam in the storage yard not too far from the site, later used for this bridge.)

That first meeting in Dean's office marked the beginning and was a catalyst for the dynamic growth of prestressed concrete in Florida. Dean's account of the meeting is of value and can be found in the fourth and fifth paragraphs in the closing paper he gave at the *First National Prestressed Concrete Short Course* held at St. Petersburg, Florida, October 10-12, 1955.

The course was cosponsored by the newly-formed Prestressed Concrete Institute and the University of Florida, Department of Civil Engineering (see Fig. 27).

At this course six memorable papers were presented.⁹ Of particular interest is Bill Dean's closing paper on the "Outlook to the Future of Prestressed Concrete." Even 23 years later, Dean's presentation is thought provoking.

(Note: Dean's paper is reprinted in the Appendix.)

Announcing!

1st

NATIONAL PRESTRESSED CONCRETE SHORT COURSE

OCTOBER 10, 11, and 12, 1955

Co-sponsored by

The DEPARTMENT OF CIVIL ENGINEERING
(as a public service function of the Engineering and Industrial Experiment Station)

and

The PRESTRESSED CONCRETE INSTITUTE

The *First National Prestressed Concrete Short Course* will offer an excellent opportunity for the practicing and student engineer to become familiar with the theory and design of prestressed concrete structures. You will have a chance to meet and hear outstanding engineers. The course will give you an outlook on the tremendous future of prestressed concrete.

- **PROGRAM:** The first two days of the Short Course will be devoted to lectures encompassing a review of beam theory, basic theory of prestressing, prestressing methods, materials used in prestressed concrete, post-tensioning and pre-tensioning, design of simply supported beams, design of beams having variable cross sections, etc. There will be design sessions where registrants will have an opportunity to design both simple and complicated structures. Each class will be limited to 50 registrants in order to permit personal supervision.
- The third day will be devoted to papers, movies and slides presented by outstanding engineers in the field of prestressed concrete. Various topics involving materials, design, manufacture, present use and future possibilities of prestressed concrete structures will be discussed.
- An optional field trip to one of the casting yards in the area is also being planned to acquaint the registrants with the manufacturing methods being employed in the production of prestressed concrete products.
- **LOCATION:** Due to the large number of engineers expected to attend this Short Course, the classroom facilities of the University of Florida and accommodations available in Gainesville would not be sufficient on the dates indicated. It is therefore planned to hold the Short Course at the Maritime Base, St. Petersburg, Florida, where facilities to accommodate the expected registration are available. Moreover, the city of St. Petersburg has ample hotel and restaurant facilities at summer rates during the time the course is to be held.

FEES. The registration fee will be \$25.00 for the three-day period. This will include box lunches for the three days and possibly an evening picnic.

HOTEL RATES are from \$2.50 to \$4.00 for single rooms, and \$5.00 to \$10.00 for double rooms. It is also possible for university students to stay in dormitories located at the Base for \$1.00 per day.

The limited size of the lecture sessions will, in turn, limit total attendance. It will therefore be necessary to register in advance. Details of the program and final registration cards will be sent to all persons indicating their interest by returning the enclosed self-addressed card as soon as possible.

Fig. 27. Flyer advertising PCI's first national prestressed concrete short course.



Fig. 28. Bill Dean and the author together at the 1955 PCI Course in St. Petersburg, Florida. During Dean's last years his eyesight was failing.

Fig. 28 shows a picture of Bill Dean and me taken at the 1955 PCI Course in St. Petersburg.

By 1955 much had happened in Florida (and throughout the United States) since the day Dean first became interested in prestressed concrete. In a letter to me he wrote:

"... In the past 5 years our prestressed practice has expanded to proportions far beyond our anticipations. We now have a dozen simultaneous projects underway with prestressed spans. Prestressed piles and other small parts are regular construction items..."

That was an understatement. Indeed, shortly after our first trip to Tallahassee, Bill Dean met Harry Edwards, a consulting engineer who had moved from the north to Lakeland, Florida, and between the two of them—well, Harry Edwards will tell the story as it happened, in his own words, in the next article in this series.

*I was Chairman of PCI's Technical Activities Committee (TAC) in 1957 and had asked Dean to serve as Chairman of the Bridge Committee.

Standardization of Bridge Beams

The design and construction of the Tampa Bay bridge had a tremendous effect on Dean. He learned, the hard way, that the *thin* minimum cross section of the beam used for the trestle, which was patterned after European practice, was *not* suited to American construction practice.

These thin beams (Fig. 29a) were inviting underflange cracking which was hard to control. The logical corrective measure was to "fatten" up the member.¹⁰ In this fashion, the beam shown in Fig. 29b came about and was subsequently used on other Florida trestles. The increase in concrete material was negligible but the benefits substantial.

The philosophy of "stubby" beams rather than "skinny" beams (theoretically equally structurally sound) was best expressed at the time when bridge beams were being standardized for highways.

About the time Dean became Chairman of the newly formed Joint AASHO-PCI Committee,* the Federal

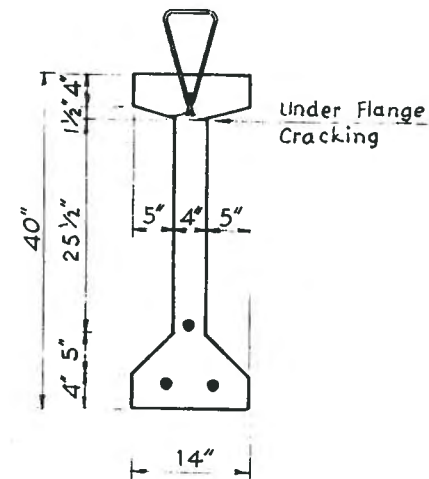

Fig. 29a. Typical underflange cracking which at times occurred in originally designed girder.

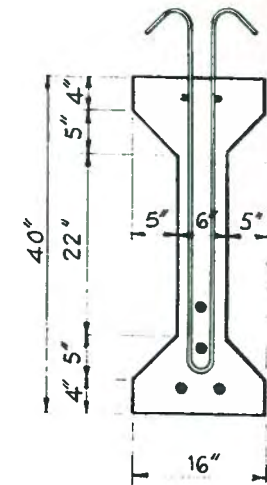

Fig. 29b. Revised Tampa Bay girder as used in subsequent structures.

Bureau of Public Works (BPW)* was ready to publish "Standards, Prestressed Concrete Beams for Bridge Spans 30 to 100 Feet." They had developed detailed "skinny" beams modeled after the European concept of beams. Dean courageously convinced the BPW of the unsoundness of their "Standards." They never were published, thus averting what would have been a disaster for the young precast prestressed industry.

Prestressed Concrete Spreads Across U.S.

Meanwhile, with prestressed concrete applications thriving in Florida and through the South, the Midwest was also developing applications. The newly formed Prestressed Concrete Corporation,† headquartered in Kansas City, Missouri (mid-1950), had developed a new post-tensioned stressing system using the "button-head" as the basis for anchorage. This system was used for the first time for two 110-ft (33.5 m) span

girders for the Arroyo Seco Pedestrian Overpass at 110th Street in Los Angeles, California.

This overpass became the first prestressed concrete structure on the West Coast. The resident engineer on that project was Ted Gutt‡ who had produced the detailed engineering drawings for the Walnut Lane Bridge.

The adventures of Gutt in the Midwest and on the West Coast in connection with prestressed concrete should make for exciting reading rounding out the story of prestressed concrete's development in the East, South, Midwest and California leaving it to Arthur Anderson to tell of the developments in the Northwest.

In other developments, Tulsa, Oklahoma, contractor Percy F. Blair and his father modified the button anchorage

* Now called the Federal Highway Administration.

†At the time, I was Chief Engineer for the Prestressed Concrete Corporation.

‡Ted Gutt is presently chairman of PCI's Plant Certification Committee and an Assistant Vice-President of the Prestressed and Architectural Concrete Division of the Tanner Companies in Phoenix, Arizona.

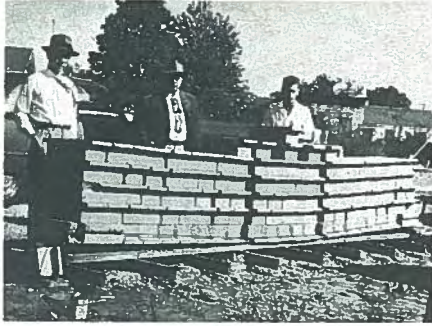

Fig. 30. Testing of soffit beam made up by masonry blocks (Tulsa, Oklahoma).

system using nuts instead of plates and cast and erected the first precast prestressed concrete buildings in the Midwest in Tulsa, Oklahoma, on designs I had made. (Fig. 30 shows the testing of the anchorage on a soffit beam made up by masonry blocks.)

Closing Thoughts

The late 1940s and all of the 1950s were exciting, fascinating and gratifying years for those involved in concrete construction and wanting to meet the challenges. They were years of pre-casting, prestressing, high strength concrete, admixtures, vacuum concrete, steam curing—one greater challenge after another.

I was in the midst of it all: the prospect of the Walnut Lane and the Tampa Bay

*When prodded, Magnel would tell us with a chuckle of the times the Palace limousine would call on Saturday mornings to deliver him to the palace for tutoring. He would wear, according to protocol, a cutaway suit with high hat. It sounds incongruous in this day and age, but that was the way it was done. Magnel had a very close rapport with King Baudouin and he intended to dedicate his prestressed concrete television and observation tower that he was designing to the King. Unfortunately, death overcame him before construction began and the prospective tower died with him, as he was the driving force.

†Those who attended the San Francisco World Conference in 1957 will still remember, no doubt the loud rebel yell booming through the banquet hall when the band started to play "Dixie." The Soviet delegation sat at his table. They could not understand it—of course they could not!

Bridges; the casting of 26,000 channel slab panels [shaped 5 by 19 ft (1.52 by 5.79 m)] in 140 concrete molds in 190 days in Albany, Georgia, for the United States Marine Corps warehouses; the advent of the headed wire; and many other facets of concrete work.

Travelling through the United States, I made slide presentations on prestressed concrete at meetings of many local ASCE Chapters and other professional societies. I had the pleasure of participating as guest speaker in a variety of symposia held at several universities, colleges and conventions. And finally I was able to contribute to the work of various technical committees.

Above all, it was my good fortune to have known and worked with such dynamic men and outstanding engineers as Professor Gustave Magnel and William E. Dean. Even with diverse backgrounds, they had much in common.

On the one hand, the international, cosmopolitan, amiable and good natured Professor Magnel could travel anywhere in the world and would be received by a delegation of former students. He was an outstanding engineer whose main interest was education although he felt testing, actual field practice and experience were essential to verify his theories. He was at home with royalty (tutoring Prince Baudouin of Belgium who later became King*) but equally at ease with the penniless student who was looking for help (and which the Professor gave liberally).

On the other hand, Bill Dean was the public servant, the impetuous Southerner deeply in love with the South and ready to fight the Civil War all over again.† He was a cautiously courageous man with daring and vision whose only ambition was to design and build better engineered structures.

He was, also, a modest professional engineer who refused nomination by the Florida ASCE Chapter for the Ernest E.

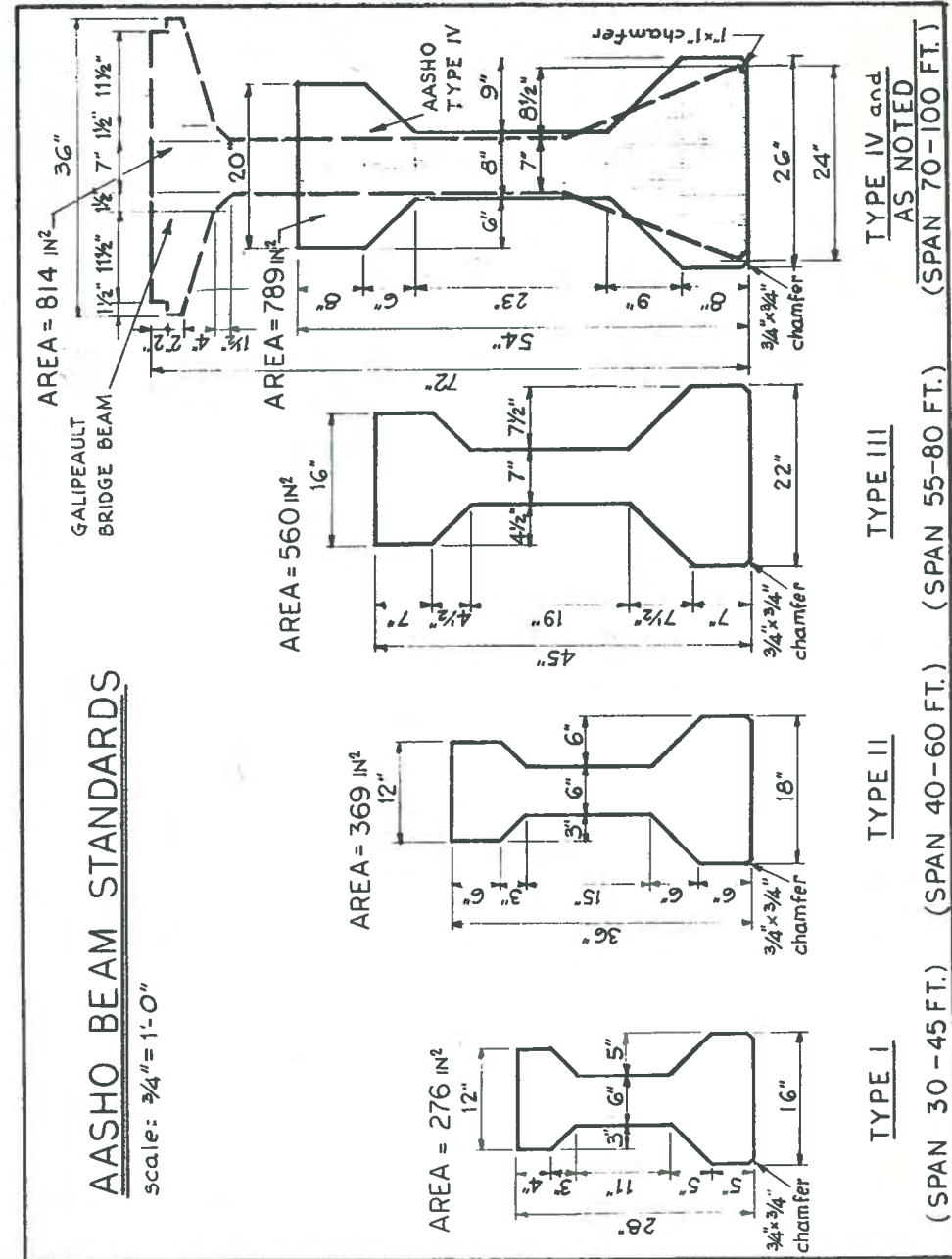

Fig. 31. European type girder (Galipault Bridge) superimposed on "fat" AASHO standard beam which solved some of the casting problems.

Howard Award because he felt others equally deserved the honor. However, when I had convinced the Nominating Committee (with Bill Dean's knowledge), that he had earned the right to be nominated, he eventually accepted it.

Both men understood the potential of prestressed concrete, what it would mean to the construction industry and mankind when the first step towards its use had been made. In their own special way, both men courageously made that first, giant step!

Prudent and cautious, Professor Magnel would progress step-by-step through tests which he planned, guided and supervised in his own elaborate laboratory where he was the master. He checked his theories and the computational results he intended to present to the profession at large and only then would he apply these in the field. Safety, through *well thought out practical engineering concepts* and excellent workmanship were his overriding criteria.

In his own way, Bill Dean was the same. He proved this when he requested exhaustive field tests on full-sized beams with and without deck slabs, for the Tampa Bay trestle before allowing fabrication of the beams. Dean understood the potential, and limitations, of American labor as related to the American economy.

This understanding was the basis for the I-beam standards as they were developed under his chairmanship. He personally made the computations, for he remained a prudent and meticulous designer even when swamped in "administrative" work. Perhaps the superimposing of the European type beam on the AASHTO-Type IV beam as shown on Fig. 31 will make that abundantly clear (see previous page).

No wonder then that the contributions

made by both men—innovative, daring for their time, but cautious—were eventually recognized by their peers. Sadly enough, the two men never met.

On October 18, 1950, at an imposing ceremony I attended, the world renowned and respected Franklin Institute in Philadelphia presented Professor Magnel with the Frank P. Brown Medal for his outstanding contribution to the development of engineering techniques for prestressed concrete. In 1957, the American Society of Civil Engineers honored William E. Dean with the Ernest E. Howard Award for his contribution to the advancement of prestressed concrete.

Both awards were well deserved and I know for a fact that both men, particularly Professor Magnel (for he was a foreigner) cherished these awards.

The Prestressed Concrete Institute honored Dean with a Special Award in 1964 for the 1548 ft (472 m) long, prestressed Sebastian Inlet Bridge in Florida. Dean's imaginative design eliminated construction falsework, through the use of precast *pretensioned* components for its 380 ft (116 m) three-span *continuous* main section.¹¹ This project is quite an accomplishment for a man who had started off with, "I have gone sour on prestressed concrete."

In 1965, Bill Dean was invited to represent the PCI the following year at the quadrennial FIP Congress (Internationale Fédération de la Précontrainte) in Paris and to present a paper on prestressed concrete bridges designed and built in the early 1960s. Unfortunately, Dean died that winter and it was left to me to pick up the pieces Dean had already prepared, to complete the paper and to present the material in Paris, which I did.

At the conclusion of the presentation, I gave homage to Dean and projected a candid photograph showing Dean lecturing at some previous convention. What a twist of fate!

Editor's Note: It must be appreciated that during all the years that Charles Zollman knew Bill Dean, Dean never once offered him a consulting job. But unwittingly, through his death, Bill Dean left him the legacy of the greatest gift one could receive, that is, the honor of officially representing the United States on behalf of the Prestressed Concrete

Institute at the quadrennial meeting of the prestigious FIP Congress in Paris.

Charles Zollman to this day admits that this meant more to him than any monetary reward that he could ever have received. As he said, "l'homme propose et Dieu dispose" (Man proposes and God disposes).

REFERENCES

1. Zollman, Charles C., "Trends in Linear American Prestressed Concrete Construction," *Precontrainte-Prestressing*, Brussels, Belgium, Nos. 1 and 2, 1952.
2. Coff, L., "Prestressed Concrete—A New Frontier," *Engineering News Record*, September 1, 1949.
3. Ziverts, George J., "A Study of Cardboard Voids for Prestressed Concrete Box Slabs," *PCI JOURNAL*, V. 9, No. 3, June, 1964, pp. 66-93 and No. 4, August 1964, pp. 33-60.
4. Bender, Brice F., and Kriesel, William G., "Precast, Prestressed Box Beams; A State-of-the-Art Report," *PCI JOURNAL*, V. 14, No. 1, February 1969, pp. 72-95.
5. Ekberg, C. E., Jr., "The Characteristics of Prestressed Concrete Under Repetitive Loading," *PCI JOURNAL*, V. 1, No. 3, December 1956, pp. 7-16.
6. Quade, Maurice N., "15 Mile Toll Bridge Under Construction Across Lower Tampa Bay," *Civil Engineering*, April, 1952.
7. Clossner, J. J., and Vick, A. D., "Prestressed Concrete Trestles Over Tampa Bay," *Construction in the South*, September 1953.
8. Dean, W. E., "Tests Establish Construction Procedures by Prestressed Beams in Tampa Bay Bridge," *Civil Engineering*, January 1953.
9. Papers presented at the *Prestressed Concrete Short Course*, St. Petersburg, Florida, October 10-12, 1955:
 - (a) Bryan, Ross, "Applications of Prestressed Concrete Principles."
 - (b) Zollman, C. C., "Structures of Unusual Design."
 - (c) Everling, W. O., "Steel Wire for Prestressed Concrete."
 - (d) Wenzel, Harold B., "High Strength Concrete."
 - (e) Smith, Eugene, "Major Prestressed Concrete Projects."
 - (f) Dean, William, "Outlook to the Future of Prestressed Concrete."
10. Dean, W. E., "Peculiarities and Shortcomings of Prestressed Concrete in Florida Bridge Practice," *PCI JOURNAL*, V. 2, No. 1, June, 1957, pp. 32-37.
11. Dean, W. E., "Sebastian Inlet Bridge," *PCI JOURNAL*, V. 10, No. 6, December 1965, pp. 35-42.

* * *

NOTE: A reprint of William Dean's paper on the "Outlook to the Future of Prestressed Concrete" is given in the Appendix on the following pages.

¹¹I applied this concept with great success for two bridges, part of a 14,000 ft (4246 m) trestle on Maryland's Eastern Shore.

APPENDIX

OUTLOOK TO THE FUTURE OF PRESTRESSED CONCRETE*

By William Dean†

The title of this paper would indicate a clairvoyant ability on my part for which I make no claim. In some twenty-five years of engineering practice I have had little experience with the use of crystal balls, tea leaves or Zodiactal science.

In recent years the prediction of future trends in developments has become a highly specialized field in business management that has important branches in engineering. While I have little detailed knowledge of the methods employed by scientific prognosticators, the general procedure seems to be a process of collecting data on trends as they have developed in the past, drawing curves from past through present and then by extrapolation projecting these curves into the future and attempting to draw conclusions therefrom.

This general procedure is a very important part of traffic engineering. In the planning of modern highway facilities recognition of probable future traffic problems, five, ten, twenty or more years in the future, is a necessary part of the design if further obsolescence is to be avoided. Traffic engineers have been quite successful in predicting general trends; however, in the matter of actual volume at some future date all these predictions very often underestimate by a considerable amount. Highway traffic is developing at an accelerated rate, and quite often the slope of the curve representing future traffic is considerably steeper than predicted. Prediction of future requirements for ten years are often reached in less than five. Demand is often

increasing faster than any past experience would indicate.

Having watched the development of prestressed concrete for the past several years, I wonder if a condition somewhat analogous to this traffic problem does not exist in the field of prestressed practice. Certainly we can say that five years ago there existed much interest in prestressed work, and there were strong indications of considerable development in the field. However, I wonder how many of us foresaw the rapidity with which the development would come about.

It is just a little over five years since Charlie Zollman made his first visit to my office in Tallahassee to discuss a possible design for use on the trestle portion of the Sunshine Skyway. Up until that time Charlie was the only engineer with any reliable information and experience in prestressed concrete that I had met; although, I had met quite a number of them that were quite inexperienced and grossly misinformed.

As a result of some of those other meetings, I must confess, as Charlie told you all this morning, that I had considerable prejudice, but I will not admit that Charlie sold me anything. He showed me by fact and by reason, and as an outgrowth of that first visit to my office, in April of 1950, the design was developed for the trestle portion of the Sunshine Skyway which did have a very important part, I think, in furthering prestressed practice in this country. I can say that Charlie introduced me to prestressing. It is something for which I will always have a warm spot in my heart and much gratitude.

We are now concluding a three-day conference designed to further prestressed practice. It has been my pleasure to attend and participate in several such conferences, and as an indication of trend we might look back

*This paper is reprinted from PCI's First National Prestressed Concrete Short Course, presented at St. Petersburg, Florida, October 10-12, 1955.

†Chief Bridge Engineer, Florida Highway Department, Tallahassee, Florida.

Written 23 years ago, many of the concepts Dean talked about are still relevant today.

and examine some of the principal developments associated with these gatherings.

The engineering profession and construction industry had a significant introduction to prestressed practice at the First United States Conference on Prestressed Concrete held at Massachusetts Institute of Technology in the summer of 1951. The sponsors of this conference had hoped for a registration of 200 to 300. Actual registration was more than twice the anticipated number. Attendance included teachers and students of structural engineering, practicing engineers, prospective manufacturers of materials for prestressing, proponents and patent holders of certain prestressing methods and a representation from the construction industry.

At that time the first major prestressed bridge in the United States, the Walnut Lane Bridge at Philadelphia, was about complete, and a few smaller bridges and structures had been built or were under process of construction in other parts of the country. Papers given at this conference described construction in the United States up to that time; however, many of the constructions described were of European structures. Valuable data on the properties of material for prestressing were given by manufacturers who were naturally looking for markets, and considerable factual data on design concepts and methods were presented.

The general air of most attendants was one of intense interest with a generous portion of skepticism. The experience of one of the contributors, with whom I am well acquainted, might be cited. With considerable brashness, and against all rules of discussion, he accepted an assignment to discuss certain theoretical and practical design concepts. A paper was conceived in ignorance, written out of a vast background of inexperience and de-

livered in an attitude involving approximately equal parts of interest and cautious skepticism.

Despite its amateurish nature some basic problems, as they appeared at the time to one average practicing engineer, were listed. Some of these were lack of: simple practical method of linear prestressing, freer patents, authentic design criteria, authentic test of large scale members on which the design criteria might be based and only a limited number of reliable construction firms with experience in prestressing. The past four years has seen presently acceptable solutions to every one of these problems.

The next conference that might be remembered was a part of the Centennial of Engineering in Chicago in the Fall of 1952. Prestressing was given a very important part on the program. Interest was such that the session on prestressing had to be moved from the original scheduled meeting place to the largest ballroom of the Conrad Hilton Hotel and even there late comers had to be satisfied with standing room only. In the year immediately past the contract had been let for the structures on the Sunshine Skyway totaling 363 trestle spans with precast, prestressed concrete girders. At the time this was the largest contract for prestressed members ever let in any part of the world.

Since that time the Skyway construction has been very considerably exceeded in other big contracts. You just saw an example of that presented by our last speaker. Now, this same brash contributor whose efforts at the MIT conference has been described was again in attendance. This time, with an increase in enthusiasm and a considerable reduction in skepticism, he described test to destruction of full size members being used on the Skyway. These tests had shown

member performance which fully justified design computations and indicated an acceptable margin of safety for the intended surface.

It is believed that these tests, which were given wide publicity in the technical press, and the use of prestressing on the Skyway had much to do with the acceptance of prestressing by both engineers and the construction industry. Certainly the contributor referred to was hard-put in answering letters from many engineers, and for months the contractor's yard literally swarmed with prospective competitors.

It might be worth noting that the MIT conference was sponsored and largely guided by an academic group, the faculty of a major technical college; the Centennial of Engineering was sponsored by four professional societies and was largely a gathering of practicing engineers. Since these conferences, there have been many others of much importance throughout the country, and hundreds of prestressed structures of many types have been designed and constructed.

The most significant development in the prestressing field in the last two or three years has been the growth of a large and healthy construction industry with numerous firms equipped and ready to manufacture many building parts of prestressed concrete. Without this group there would be little prospect of rapid advancement in the field. The method of construction may be the subject of advanced thinking in research, it may be put in the form of workable plans, but under our American system of operation, which pray God may never change, it is of little value until sound business men consider it sufficiently practical to warrant capital investment from which a profit can be reasonably expected. The large growth of prestressing plants, representing the substantial capital investments by many business firms, indicates the practical acceptance of the method by this important group.

It might be worth pointing out that in the development and advance in structural practice, the work of the academic group, of the practicing engineers and the business men from the construction and materials industries form inseparable and interrelated parts. Major advancement without the proper contribution

of any one of these groups would be as unlikely as a tripod standing on two legs. I might say, parenthetically, that although many men may have similar educational backgrounds, it appears that there are certain factors of temperament and disposition and thinking that will usually place a man particularly in one of these groups.

I have often noticed some of my associates who have become established in one of these groups try to get into another, and too often they are not successful at it. I notice on our program listed under the officers of the Prestressed Concrete Institute two engineers who are business men and one practicing consulting engineer; under the directors I see three business men and one who is a very noted teacher and author. To me that is a significant grouping of men. It is a significant combination of talents, and I think that the success that we have enjoyed in prestressing, the success that has been realized, cannot be attributed to any one of those groups, but all have had their importance and necessary part in it.

This particular conference, while directed by the academic group and participated in by all the above mentioned groups, has a very strong backing of the business firms making up the principal membership of the Prestressed Concrete Institute. This has been a happy and progressive partnership. The registrants have come from all groups, and work here has been, at least to this speaker, distinctive. We have not only heard informative general papers but have spent two days in consideration of detailed design standards; its basic significance, to me, my friends, occurs here.

These past three days we have not only been preaching the gospel, we have been receiving members into the congregation. As at all other prestressed conferences attended by the speaker, the interest here has been keen; however, to me it has been particularly significant due to the general registrant participation. We might ask how it is possible to get a large group to attend a conference like this and to do the detailed work of this one. Probably the answer is that most of us realize that if we are to keep abreast of structural practices, we have no choice in the matter. Prestressing as an accepted construction

method is here with us. Accepting this as a fact, it behooves all of us to learn how to live with it, to learn its applications together with its limitations.

At several points in this paper reference has been made to significant advances and developments. Certainly any mention of these would be lacking if the *Criteria for Prestressed Concrete Bridges*, published by the United States Bureau of Public Roads, was omitted. While these criteria were developed principally to govern highway bridges, they are laws that are applicable to prestressing in general. Most engineers very properly look askance at any radically new technical development until it has been subjected to exhaustive test, tried in the light of experience and suitable rules for its use are developed.

Some two years past, a joint committee of two of the major technical societies of the country was set up to develop a code for prestressing. The establishment of this proposed code by this committee has been delayed for various reasons, and in the meantime prestressing is so logical and practical and has aroused such wide interest that construction would not wait for the development of the code. In order to achieve uniform practice in highway bridges, the Bureau sought out and sorted a composite of the most informed opinions and presented their criteria to the engineering and construction industry.

There is hardly any way to measure the importance of this booklet to the development of prestressing practice. Many engineers who are hesitant, or in doubt as to the proper applications, unit stresses, design concepts and so forth, have been reassured by knowing that an organization having the well deserved prestige of the Bureau, with its background of careful, conservative practice, has officially approved prestressed construction. The *Criteria*, where possible, will be revised and improved from time to time; however, as presently published, they can be used with the assurance that structures designed in accordance with their specification will produce serviceable, practical structures with adequate margins of safety.

So far, we have been looking backward

and touched on a very few high spots in the advancement of prestressed concrete from a logical and interesting theory of a few years past to the practical and generally recognized construction method of today. Perhaps the trend that has been shown has been sufficiently evident to warrant a little prognostication. It does not seem that we would need any crystal ball, tea leaves or other impedimenta and paraphernalia of the occult art to say that prestressed concrete has earned a permanent place in American construction practice. It is not going to supplant the older and universally accepted construction methods in reinforced concrete, steel or timbers, but it does add another type from which a choice can be made. While prestressed concrete will not supplant conventional construction types, there are many applications where it can be expected to do a better job, and in these applications it will certainly take over. To try and list these applications would be pointless. It would seem sufficient to say that as hundreds have been found in the past, thousands will probably be found in the future.

Getting back to that MIT conference and that amateurish paper by the rash contributor, about the only statement with any degree of sagacity, and that only a simple truism, was the following concluding statement: "When we learn to build as good a structure as we are now building at a reduction in cost or a superior structure for the same cost, prestressed construction is sure to gain a wide acceptance in American structural practice." The conditions set forth in this four year old statement have been fully met, and the predicted acceptance has been realized.

In concluding it might be appropriate to observe that all of us who expect to make a living in structural work, whether we belong to the academic group, practicing engineers or the construction industry, will do well to learn as much as possible about prestressing, its design, its applications, construction methods and limitations, for if we are to keep abreast of modern practice, we will be dealing with the subject of prestressed concrete for the rest of our careers.

William Ennes Dean

(1909-1965)

In 1970 the Florida State Legislature posthumously honored **William E. Dean** by renaming the Tampa Bay Bridge after him and issued a special commendation honoring Dean for his contributions to the economy of the State of Florida. This event is historically significant because it recognizes the professional contributions and public services rendered by an engineer to the nation's welfare.

Published below for the first time is the full text of an address given at the bridge dedication ceremonies in St. Petersburg, Florida, November

20, 1970. The material adds further dimension to Dean's contributions and insight into his personality. The information also provides a valuable supplement to Charles C. Zollman's Part 2 article on "Reflections on the Beginnings of Prestressed Concrete in America," published in this book pages 33 through 71.

It should be appreciated, of course, that the bridge being dedicated is the same Tampa Bay Bridge which was extensively discussed by Zollman in the aforementioned article.

EDITOR

The Bill Dean We Knew*

McLeod C. Nigelst

Vice-President, Florida Prestressed Concrete Association

I have a difficult task before me today in that I, as spokesman for the prestressed concrete industry, have been charged with the responsibility of putting into words our feelings toward Bill Dean and what he meant to our industry.

The task is difficult because our feelings are deep feelings of admiration and respect and are almost impossible to express in mere words. I am honored to have this responsibility just as it was an

honor to know and be associated with Bill Dean.

The bridge that is being named today in honor of Bill Dean is the first bridge in which prestressed concrete I-beams were used in any quantity in the United States. Bill Dean was 42 years old when he designed these beams. He had been promoted to the position of Bridge Engineer only 2 years prior to this time. I wonder how many of us here today would have had the courage to try something as new as prestressed concrete was to this country at that time on a project of this magnitude. There was

no prestressed concrete industry in the United States; only a few companies specializing in the construction of circular storage tanks.

In 1950 there was only one plant in the country producing prestressed concrete products for buildings and bridges. Today there are more than 320 such plants in the United States and Canada. Our industry has experienced a tremendous growth in the 19 years since Bill Dean stuck his neck out and designed this structure. Growth of this nature doesn't "just happen." It takes men with foresight on the side of industry such as the first three presidents of the Prestressed Concrete Institute, namely, Douglas Cone, George Ford and Ashton Gray, with a willingness to work faithfully and devote themselves in order to be able to offer a better way of doing something.

It takes more than that, however. For an offering to be successful it must be accepted and it isn't always easy for those in positions of responsibility to accept something new, particularly when the general public is involved as the purchaser. Bill Dean had this kind of courage. It paid off on this bridge for when the bids were opened, the prestressed concrete proposal proved less costly than conventional construction.

This bridge was, for a number of years, the longest prestressed concrete trestle span in the world. Engineers from all of the other states came to review and inspect the project and Mr. Dean had attained his place of leadership in the field of prestressed concrete.

From that time on Bill was convinced that large numbers of prestressed concrete bridge components could be mass produced in central plants and result in economical, durable and maintenance-free bridge construction. He set out to develop standard sections and to include their use in bridge projects throughout Florida. In order to be sure of their economy the Road Department



William E. Dean. In background is the Sebastian Inlet Bridge for which Dean received a special PCI Award in 1964.

prepared two designs for these structures and placed the prestressed beams in competition with other materials. In 40 projects they never lost a competition!

Bill served as chairman of the AASHO-PCI Committee that developed the standard sections that are still in use today. He instigated research at the University of Florida from 1952 until 1958 in order to improve on the design and economics of prestressed concrete. It is also true that he didn't always wait for the results of research before putting his theories into practice. In an address at Purdue University in 1962 he said:

"The normal procedure in the establishment of any structural practice is to complete many tests and much significant research before putting the new system to work. In some cases, prestressed practice has not followed this conventional procedure. The techniques of prestressing have developed so rapidly that research has often been hard put to keep abreast of practice. In much of our work, reason and intuition

* Full text of an address given at ceremonies naming the W. E. "Bill" Dean Bridge in St. Petersburg, Florida, November 20, 1970.

† Currently, Vice President, Sales and Engineering, Prestress Concrete Co., Inc., Charleston, South Carolina.



Mrs. W. E. Dean and family pictured at dedication ceremonies, Nov. 20, 1970.

have told us to go ahead. At the same time, we set up research projects to test our theories. Thus, practice has often preceded research."

I am not pointing out this statement to you to indicate any lack of thoroughness or caution in Mr. Dean's career philosophy. He was, on the contrary, most thorough in his deliberations and you could be sure that he was quite positive of the validity of his engineering theories before he would allow them to be incorporated in any construction. He was an outspoken proponent of professionalism. In his keynote address at the 1957 World Conference on Prestressed Concrete he cautioned:

"Prestressed concrete is an engineered material. Design engineering cannot be entrusted to draftsmen and other sub-professional office help. There is no magic in the application of prestressed concrete. All of the principles of mechanics of materials still apply and the law of gravity has not been repealed simply because we have become adept at overcoming an inherent weakness of concrete."

Mr. Dean stressed the need for competent design procedures and a high standard of quality in production techniques. He was our friend as producers but he never hesitated in giving us a loud and emphatic *NO* to our requests if he felt that they were not to the best interests of the State and therefore to the people of Florida. And we respected him for that.

I have never once in my career met anyone in the prestressed concrete industry who had anything but the highest respect for Bill Dean. You always knew where you stood with him. He made it perfectly clear as far as his position was concerned and when he expressed himself there wasn't any doubt in anybody's mind where he stood as to a given subject.

It was this quality of forthrightness for which I personally respected him the most. He had no problems in communicating his thoughts to those around him and I am convinced that it is the lack of this power of communication that causes much needless tribulation and

misunderstanding in our human relationships today.

Bill Dean had another quality that made him unique. He was, as I have said, known throughout the world as an authority in the field of prestressed concrete bridge design. Regardless of his fame, however, he never let his importance separate himself from the common man. He could carry on a conversation with the lowest echelon laborer in the prestressed plants to which he made frequent visits just as easily as he could with the president of the company or the other high ranking officials with whom he associated. He was obviously more enthused about what he saw in the future for prestressed concrete design than he was impressed about his own accomplishments of the past.

He was awarded the Ernest E. Howard Award by the ASCE in 1957 "for outstanding contributions and pioneer work in the design and use of prestressed concrete, particularly as related to bridge construction."

After his retirement in 1962 and while working with Howard Needles Tammen and Bergendoff he served as a consultant to the PCI and prepared the *Manual of Quality Control for Plants and Production of Precast Prestressed Concrete Products*.

Perhaps the climax of his career was the design of the Sebastian Inlet Bridge for which he was justly proud—a 180-ft clear span across the channel with precast, prestressed, plant produced beams! A heretofore unheard of feat of engineering that won him a special award from the PCI in 1964.

He was named "Engineer of the Year" by the Florida Section of the ASCE in 1965. A full color picture of Bill with the Sebastian Inlet Bridge in the background appeared in the Sunday, December 5 edition of the *Orlando Sentinel*. We immediately wrote Bill to congratulate him

THE W. E. "BILL" DEAN BRIDGE

A WORLD RENOWNED BRIDGE ENGINEER
FLORIDA'S PRESTRESS CONCRETE
PIONEER AND AUTHORITY ON MOVABLE
SPAN BRIDGES. A GENTLEMAN ENGINEER
SUPERBLY VERSED IN DESIGN AND
CONSTRUCTION PRACTICES.
HIS CONTRIBUTIONS TO FLORIDA'S
ECONOMY IS RECOGNIZED BY THIS
MEMORIAL PLAQUE AND BRIDGE.

SERVED THE FLORIDA STATE ROAD
DEPARTMENT 1932-1962

DESIGNATED BY
1970 LEGISLATURE OF FLORIDA

Inscription on W. E. Dean Bridge plaque.

and to ask him where we might obtain a copy of the photograph.

Today, that photograph hangs in our office and a postcard dated December 15, 1965, just 15 days before his untimely death, is taped to the back side. I think it typifies his personality. It reads:

"Thanks so much for your congratulatory letter. These newspapers have to fill up space somehow and I was just odd-ball enough to qualify. The color photo can be obtained thru the Sentinel Star Photo Office but it sure as Hell ain't worth the price."

Mrs. Dean, that picture of your husband, with the postcard on the back couldn't be bought today at any price! I only wish that everyone could have known Bill Dean as we were privileged to know him. I wish that every young engineer could somehow experience the enthusiasm that he felt about everything worthwhile in life, could exhibit the courage that was his and the dedication that he had to his profession. He set an example for all of us to follow. He served his State and nation well and we're proud to have had a part in this ceremony today.



Part 3—
The Innovators of
Prestressed Concrete
in Florida

by
Harry Edwards

Part 3

The Innovators of Prestressed Concrete in Florida



Harry Edwards
President
Leap Associates, Inc.
Lakeland, Florida

The key to the success of the prestressed concrete industry lay in developing a high quality, well-engineered, competitive product.

The successful completion of the Walnut Lane and Tampa Bay bridges in 1950 and '51 showed very convincingly the tremendous potential of prestressed concrete. Nevertheless, several nagging questions remained unresolved. For example:

- Would prestressed concrete be solely confined to long-span "monumental" type structures?
- Would prestressed concrete components have to be "custom-made" for each individual structure?
- Could the same principles that were being used successfully for bridges also be applied for buildings and other structures?

- If mass production under controlled factory conditions was the key to the solution what types of prestressed concrete components would be desirable?
- Lastly, and most importantly, if the technological obstacles could be overcome, was there a sufficient incentive (i.e., a profit motivation) for business men to invest considerable capital in plant facilities, materials, machinery, transportation and erection equipment?

The answers to these and other vexing questions were being tackled in other parts of the country. However, it was in Florida where much of the early pioneering work was

Based on his experiences, the author reflects upon the beginnings of the precast prestressed concrete industry in Florida. He narrates the events that led to the development of design recommendations for pretensioned members, the advent of standardized sections (especially the double-tee) for buildings, the construction of the early precasting plants, and some of the problems and solutions.

done. In short, it was the innovators in Florida who spearheaded the developmental work and set the pace for the rest of the country to follow.

What were the events and coincidences that led to this development and who were the innovators? But before we get into the details let's momentarily backtrack.

How it all Began

Like many things in life that later become important to us, the concept of prestressing did not come to me dramatically. After graduating from the University of Florida in 1936, I became extremely interested in structures and their method of erection. Being an avid reader, I would spend much of my time at the local library searching for practical information on construction.

I first became aware of the capabilities of prestressed concrete in the late thirties in reading the works of European pioneers such as Freyssinet, Hoyer and Abeles. Most of the work being done at that time was related to post-tensioning involving long-span structures. Nevertheless, I was particularly intrigued by the

pioneering work of E. Hoyer* in Germany (between 1935 and 1939) in which he cast thin flat slabs 2 in. (50 mm) thick by 4 ft (1.2 m) wide and pretensioned them using very thin [0.08 in. (2 mm) diameter] cold-drawn high strength piano wire. To ensure adequate bond between the steel and the concrete, Hoyer, out of necessity, had to use very small diameter piano wires, the number of which became very large as the span increased.†

What impressed me so much about Hoyer's work was that his pretensioned slabs were very strong, flexible and durable. Their use was also quite versatile because the slabs could be used with or without topping. Unfortunately, the reason why the slabs did not become commercially successful (discounting the impact of World War II) was that because of bond requirements only small diameter prestressing wires could be used. Indeed, the wires were so small that many such wires were required for a given slab span to the point that Hoyer could not use large-sized aggregates.

*Originally from Czechoslovakia, Professor Hoyer conducted his experimental work on prestressed slabs at the Technical University of Braunschweig in Germany.

†The smaller the diameter of the wire, the larger is its ultimate strength provided the wire is sufficiently ductile. An ultimate strength of 350,000 psi (2420 MPa) was not unusual for these piano wires.

The Author

Harry Edwards is president and founder of Leap Associates, Inc., a consulting engineering firm headquartered in Lakeland, Florida. Since its inception in 1950, the firm has concentrated its services almost exclusively to the engineering development and promotion of pretensioned products and the computerized design and analysis of prestressed concrete structures.

Mr. Edwards obtained his BS degree in mechanical engineering from the University of Florida at Gainesville in 1936 and is currently a registered professional engineer in Florida and 16 other states.

During World War II he worked for Wright Aeronautical Corp. in Woodridge, New Jersey. In 1945 he moved to Florida joining International Minerals & Chemicals Corp., where he designed and supervised erection of mining buildings for 5 years.

After forming his own company he was responsible for designing the early precasting plants in Florida where he introduced new cross sections (especially the double-tee) which Leap developed. His firm designed many of the early pretensioned structures in Florida.

Mr. Edwards played a major role in the formation of the Prestressed Concrete Institute and served as its first Secretary-Treasurer from 1954 to 1956.

As a result his mix consisted only of sand, cement and water—almost a grout which was unsatisfactory for large scale operations.

The state-of-the-art of pretensioned concrete stayed nearly dormant until about 1950, with the advent of the stress-relieved seven-wire strand.

* * * *

Meanwhile, I was following very keenly the successful construction of the Walnut Lane and the Tampa Bay bridges as well as some European projects. Based on my knowledge of Hoyer's experiences, the question that kept popping in my mind was:

► *If post-tensioning was being shown to be so successful in these long span bridges, why could not the same principles be applied in shorter span structures, say for buildings and other structural applications, but using pretensioning?*

Of course, the obvious answer was in developing an efficient mass production technique which could manufacture prestressed concrete products along typical American assembly line production techniques.

Nevertheless, before such a concept could be implemented, in 1950 there remained a multitude of problems to be solved. For example, from a design engineer's viewpoint there were:

- No design criteria, specifications or building code requirements on prestressed concrete.* This, of course, would involve the task of developing satisfactory design criteria and specifications which in turn would have to be accepted by local building code officials.
- No research data available in the United States which would substan-

*The *Criteria for Prestressed Concrete Bridges* was published in 1954 by the U.S. Bureau of Public Roads, and the report by ACI-ASCE Joint Committee 323, *Recommended Practice for Prestressed Concrete* (which formed the basis for the subsequent provisions in the ACI Code), was not published until 1958.

tiate satisfactory prestressed member performance in the structure.

- Scarcity of technical information on prestressed concrete in American periodicals and other literature. Although there was some European design information on prestressing most of it dealt with post-tensioning long span structures and furthermore was in a foreign language needing translation. There also was the problem of reconciling European construction methods with American practice.
- Very few American engineers or contractors knowledgeable in the practice of prestressed concrete.
- No local or national organizations to lend guidance and give stature to such an industry.

From a potential precaster's viewpoint there were even more unanswered problems:

- Except for the plant in Pottstown, Pennsylvania, which produced bridge beams (see discussion by Zollman in previous article), there were no prior American experiences with pretensioned products using long-line casting beds.
- Prestressing steel was in the form of small-sized smooth wire which required a large number of such wires for any sizeable span.

*Beyond a certain length, conventional reinforced concrete members become inefficient and uneconomical. The increase in weight makes the member too heavy and produces excessive deflection with accompanying cracking and other problems.

†Span length is very arbitrary and unfortunately there is a tendency to "stretch" spans beyond admissible limits. Strictly speaking, span length should be correlated with the load to be carried by the member, its deflection and other design criteria.

In the late forties some precasting plants in the United States were producing 2-in. (51 mm) thick, 2-ft (0.61 m) wide reinforced concrete planks having a span of 8 to 9 ft (2.44 to 2.75 m). Also, 2-ft (0.61 m) wide channel slabs having stems 3½ in. (89 mm) deep and a slab thickness of 1½ in. (38 mm) spanning 8 ft 6 in. (2.59 m) were being produced in some areas of the United States (Alabama, Ohio, New Jersey, for example).

In 1950 hollow-core slabs beyond 20 ft (6.1 m) were reportedly being produced by Flexicore. Also, some reinforced channel slabs up to 30 ft (9.2 m) were said to be made by Rackle Co. in Cleveland, Ohio.

- Chucks for gripping and anchoring the wire to the abutments were crude or inefficient.
- Hydraulic jacks for tensioning the wire were either inefficient or borrowed from other building trades.
- An efficient method for producing high strength concrete [at least 4000 psi (27.6 MPa)] was needed. At the time (1950) concrete strengths greater than 3000 psi (20.7 MPa) were rare in most ready-mixed concrete operations.
- There was a lack of efficient curing methods which would produce early concrete strengths.
- There was an absence of efficient forming equipment.
- Lifting equipment was limited.
- There was a lack of skilled labor and knowledgeable plant engineers.
- Lastly, assuming there was a sufficient market for pretensioned products, would the components be competitive with other building materials. In other words, would the return on capital justify the initial investment?

Despite the many technical and financial uncertainties, there were also some very positive indications that a precast concrete industry for buildings and other structures could succeed in Florida. For example:

- Florida (and other parts of the country) were in the midst of a building boom. There were also signs that the Federal and State Bridge and Highway Programs would be revitalized and expanded.
- There was an increasing demand for longer spans and crack-free members.*
- There was a shortage of structural steel.
- The precasting state-of-the-art was such that conventional reinforced concrete slab lengths could not extend much beyond 15 ft (4.6 m) for normal loads.† This situation then presented an ideal opportunity to in-

crease span lengths through prestressing.

- Efficient span limits had been reached for conventionally reinforced beams and girders. Industrial plants and warehouses were usually designed on the basis of 20 x 40 ft (6.1 x 12.2 m), 30 x 40 ft (9.2 x 12.2 m) bays or 20 x 60 ft (6.1 x 18.3 m) modules for parking structures. The above considerations suggested the need for standardization of building components.
- Florida has a warm climate insuring year-round production without protective enclosures. In most areas supplies of aggregates and cement were more than adequate to meet the demand. Furthermore, labor was relatively cheap. These were all ideal factors to encourage production facilities along assembly line procedures.
- There was already a well-established concrete industry producing ready-mixed concrete and machine-made blocks.

The above considerations gave me an added incentive to form Lakeland Engineering Associates, Inc.,* which I did in 1950 with the assistance of two other engineers, J. D. Raulerson and Roy Hill.† One of our goals was to explore the feasibility of using standard pre-tensioned concrete products for buildings and other structures.

Development of Design Recommendations

We quickly found out that there was very little technical information on prestressed concrete that could be used directly for the design of buildings. Therefore, we had to develop our own design criteria in connection with allowable stresses, prestress losses, release strengths, limits on camber and deflection, as well as other design requirements. These guidelines became the

first set of recommendations for pre-tensioned concrete as a guide for precasters in the United States to be used in Architects' specifications.

During those early days there were many diverse opinions as to the exact wording and values for many of the design recommendations. One complicating factor was the rapidly changing state-of-the-art. Nevertheless, the recommendations that we developed (with help from several individuals) ultimately formed the basis for PCI's first *Specifications for Pretensioned Bonded Prestressed Concrete*, published in 1954 (see Fig. 1).‡ Later these same specifications formed the nucleus for the ACI-ASCE Joint Committee 323 Recommended Practice for Prestressed Concrete, published in the January 1958 *ACI Journal*.

Early Prestressed Buildings in Florida

The opportunity to design our first prestressed concrete buildings came early in the fifties. The first was a short-span flat slab job for a housing project and the next a long-span roof beam system for a warehouse. Both jobs involved site cast pretensioned concrete.

Belle Glade project

The first important job in 1952 entailed the design of precast flat slabs for a low cost housing project for migrant workers in the Everglades produce region near Belle Glade, Florida. The top soil, where the building was to be located, was a

*Within 4 years our name was changed to LEAP Associates, Inc., a contraction of Lakeland Engineering Associates in Prestressed Concrete.

†Beginning in 1951 (part time) and then permanently in 1953, Paul Zia, a brilliant young engineer (who had been highly recommended to us by Prof. T. Y. Lin) joined Leap and was very helpful to our firm both as a designer and project engineer. Zia later joined the Civil Engineering Department faculty at the University of Florida at Gainesville.

‡These specifications were formally adopted by the newly formed Prestressed Concrete Institute on October 7, 1954, and became effective throughout the industry on November 7, 1954.

Standard SPECIFICATIONS

For Pre-Tensioned Bonded Prestressed Concrete — Adopted by the PRESTRESSED CONCRETE INSTITUTE, October 7th, 1954, effective November 7, 1954. Amended March 7, 1955.

Section 1. SCOPE

(A) These specifications cover the design and use of Pre-tensioned Bonded Prestressed Concrete, in any structure to be erected under the provisions of these specifications.

Section 2. DEFINITIONS

(A) The term 'Pre-tensioned Bonded Prestressed Concrete' refers to the concrete in which the prestressing strands and/or wire are tensioned, before the hardening of concrete, between fixed abutments in a prestressing bed, or against strong moulds. When the concrete has hardened, the connection between the strands (and/or wire), and the abutments are released and the pre-tensioned strands (and/or wires) will contract and thus to create mainly internal compressive stress in concrete through bond between the strands and the concrete.

(B) The definitions of all other terms pertaining to prestressed concrete shall conform to the latest report of Joint ACI-ASCE Committee 323.

Section 3. MATERIALS

(A) STRAND

(1) All strands shall be of the 7 wire type having one center wire and six outside wires. The center wire shall be enough larger than the outside wires to guarantee that each of the outside wires will bear on the center wire, thus gripping it.

(2) All strands shall be of stress-relieved as a unit after the wires have been formed into a strand.

(3) Strand properties shall conform to the following table:

STRAND DIAMETER	APPROXIMATE AREA SQUARE INCHES	MINIMUM ULTIMATE STRENGTH (LBS.)
3/16	.0214	5,500
1/4	.0356	9,000
5/16	.0578	14,500
3/8	.0799	20,000
7/16	.1089	27,000

Minimum 0.2% yield stress equals 0.85 of ultimate.

Minimum elongation in ten (10) inches equals 4%.

Fig. 1. Copy of PCI's first Specifications for Pretensioned Bonded Prestressed Concrete Products. These Specifications were formally adopted by the newly-formed Prestressed Concrete Institute and became an industry standard on November 7, 1954 (less than 6 months after its formation).

(B) WIRE

(1) All wires shall be of stress-relieved type and not larger than 1/8" in diameter. Their properties shall conform to the following:
Minimum ultimate strength equals 250,000 psi.
Minimum 0.2% yield stress equals 0.80 of ultimate.
Minimum elongation in ten (10) inches equals 4%.

(C) REINFORCING STEEL

(1) All deformed steel bars and/or welded steel wire fabric for concrete reinforcement shall meet the standards of the latest ASTM specifications.

(D) CONCRETE

(1) Concrete shall meet the required strength as called for on the plans and shall be manufactured, transported and deposited in accordance with the latest recommended practices of American Concrete Institute.

(2) Except poured-in-situ topping, concrete shall have a minimum ultimate strength of 4000 psi.

(3) Air entraining cement or suitable admixtures may be used to increase workability of concrete.

(4) The size of coarse aggregate in the concrete shall meet the spacing requirements of prestressing steel and/or reinforcing steels, and in no case shall be larger than one (1) inch.

Section 4. DESIGN STRESSES

(A) PRESTRESSING STRAND AND WIRE

(1) Initial stresses shall not exceed 70% of minimum ultimate strength for stress-relieved strand and/or wire.

(2) Loss in initial prestress due to creep, shrinkage and plastic deformation shall be assumed not less than 16%.

(B) CONCRETE

(1) Maximum allowable stresses in concrete at the time of transfer of prestressing shall be as follows:

Compression in Bridge Members	0.50 f _c
Compression in Building Members	0.55 f _c
Tension	0.06 f _c
Unless additional is taken by reinforcing steel.	

(2) Maximum allowable stresses under final dead and live load conditions shall be as follows:

Compression in bridge members.	0.40 f _c
Compression in building members	0.44 f _c
Tension in bottom fiber in bridge members	0.
Tension in bottom fiber in building members	0.05 f _c
Tension in top fiber.	0.04 f _c
Unless the additional is carried by reinforcing steel, but not more than 0.08 f _c	
Diagonal tension	0.04 f _c

(C) When concrete of light weight aggregate is used, data on stress losses due to creep, shrinkage, and plastic deformation should be presented and these stress losses used instead of those listed under 4 (A) (2).

Section 5. DESIGN DETAILS

(A) The spacing of prestressing strands and/or wire shall be the largest of the following:

(1) The center to center distance of prestressing wires shall not be less than three times the wire diameter.

(2) The center to center distance of prestressing wires shall not be less than four times the strand diameter.

(3) In either case, the clear spacing between strands and/or wires shall not be less than one and one-half times the maximum size of coarse aggregates.

(B) The minimum distance from any concrete face to the center of a wire or strand shall be three times the wire or strand diameter, or one-half its diameter, plus one inch, whichever is greater.

Section 6. CONSTRUCTION

(A) All materials, details and procedures shall be as called for on the plans or by the engineer.

(B) Prestressing strands or wires, and all reinforcing steel as called for on the plans shall be accurately placed in position before concrete is poured.

(C) Care should be exercised to keep strands or wires clean of form oil and other substances harmful to bond.

(D) Strands or wires may be tensioned and anchored all at once or one or more at a time at the discretion of the manufacturer.

(E) When two or more strands or wires are tensioned simultaneously means, as approved by the engineer, shall be provided to obtain equal tension in each strand or wire as it is practical.

(F) For stress-relieved strand or wire, pre-tensioning force shall be determined either by elongation based on the modulus of elasticity of the strand or wire or by load measured by calibrated gauge, or by both.

(G) Forms are preferably of permanent type made of steel or concrete. Quality wood forms as to produce smooth finished product may also be used.

(H) Concrete shall be deposited, vibrated, finished and cured in accordance with the latest recommended practices of American Concrete Institute.

(I) Where the surface of a prestressed member is to receive a concrete topping,

this said surface shall be finished rough, by brushing it with a steel wire brush, or equal means, so as to increase the bond between the member and its topping.

(J) At least three standard test cylinders shall be prepared at the time the concrete is deposited for each production line to determine the concrete strength of the casting at different ages.

(K) Pretension in the strands or wires shall be released from the anchorage gradually and simultaneously.

(L) Unless otherwise approved by the engineer, this transfer of prestressing force shall be done when concrete has reached a minimum strength of 4000 psi.

(M) Forms shall be so designed that they will not restrict the longitudinal movement of the casting when the prestressing force is transferred.

(N) Unless approved by the engineer, the finished products of prestressed concrete shall be lifted and/or supported at the points shown on the plans, or at the supporting points of the member when it is put into service.

(O) Bearing and anchorage of the prestressed concrete members shall be in accordance with the plans.

(P) Before shipment, all prestressed concrete members shall be inspected to make certain that materials and workmanship conform to the requirements of these specifications.

PRESTRESSED CONCRETE INSTITUTE
P. O. BOX 495 **LAKELAND, FLORIDA**

Fig. 1. (cont.). PCI's first Specifications for Pretensioned Products (1954).

Fig. 1. (cont.). PCI's first Specifications for Pretensioned Products (1954).

rich, mucky humus over a thin rock layer. There was no other choice but to use a suspended concrete floor with foundations going down to the rock stratum.

The contractor wanted to precast the floor slabs on site in order to speed up construction. A preliminary analysis showed that when the 15-ft (4.6 m) long slabs were designed using standard reinforcing steel they became unduly thick and expensive. Remembering Hoyer's work, I, of course, jumped at the opportunity to use prestressing wire in place of the reinforcing steel and thus reduce the thickness and weight of the slabs. I presented this alternative proposal to the contractor, Bert Roemer, and the owner who readily accepted my suggestion.

The resulting prestressed slab design was actually quite similar to the slab proportions that Hoyer had used in the late 1930s. However, in place of sand we used pea gravel and instead of 0.08 in. (2 mm) diameter piano wire we specified a prestressing steel with a 0.196 in. (5 mm) diameter smooth single wire. The slab thickness was about 4 in. (102 mm).

The contractor ordered the wire from Roebing Corp. in Trenton, New Jersey; in fact the wire had already been shipped to the construction site in Florida. However, before it was actually put into use, we received a telegram from Roebing saying that they had just finished testing a brand new stress-relieved seven-wire strand with a 1/4-in. (6.35 mm) diameter. The message went on to say that the strand had shown remarkably superior bond characteristics as compared to the smooth single wire we had ordered. Furthermore, Roebing stated that they would even be willing to exchange the wire they had already shipped to the site for the new strand at no extra charge. Would we be interested?

Despite the fact that the performance of this new strand was unknown to me, I

immediately recognized that this might be the breakthrough we were hoping for and accepted the offer. As we anticipated, the strand performed very well and although the size of the strand was relatively small by today's standards and the slab spans were quite short, the job proved decisive in setting the stage for the future use of seven-wire strand in building construction.

The new strand had three major advantages over the smooth wire.

- (a) Better bonding properties than smooth single wire.
- (b) Because of its larger size, fewer strands would be needed thus producing a more efficient prestressing and concrete placing operation.
- (c) This in turn permitted the use of a larger-sized aggregate, meaning, of course, that conventional ready-mixed concrete could be used, and finally
- (d) Larger member cross sections were now possible.

Sarasota project

The next important prestressed job came in 1953. The task before us was to redesign the roof system for a 60 x 120-ft (18.3 x 36.6 m) warehouse owned by West Florida Tile & Terrazzo Distributors, Inc., in Sarasota, Florida. By using prestressed beams to support the precast foam concrete roof slabs, we were able to eliminate the pipe columns which were originally designed to support steel bar joists.¹

To span the roof we used eleven 60-ft (18.3 m) prestressed tapered I-beams, each weighing 6½ tons, placed at 10-ft (3.05 m) centers (see Fig. 2). The beams were symmetrical with total depth varying from 30 in. (762 mm) at midspan to 18 in. (457 mm) at the ends. The flange was 14 in. (356 mm) wide and 3½ in. (89 mm) thick at the edge. The web was 3 in. (76 mm) thick. Four intermediate stiffening ribs were used as shown in Fig. 2.

Each beam was pretensioned with

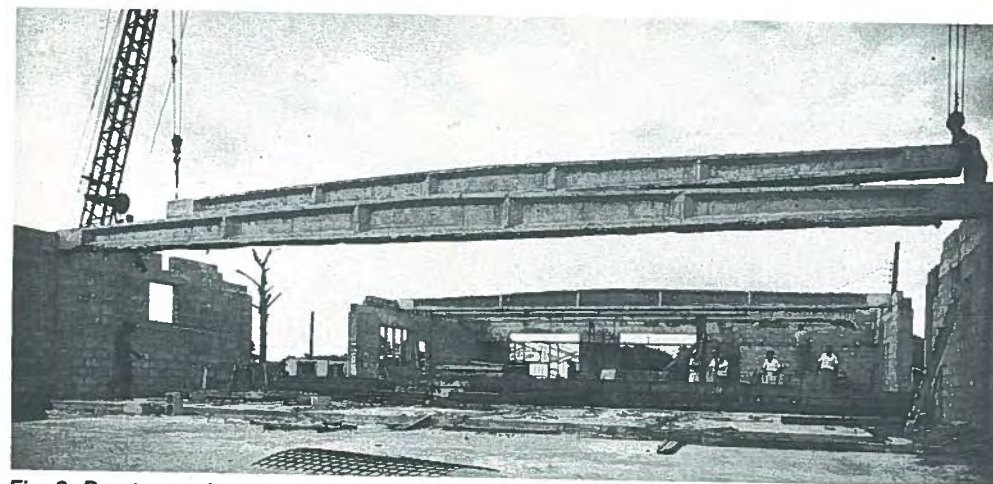

Fig. 2. Prestressed tapered I-beams being erected in 1953 for warehouse roof in Sarasota. The 60-ft (18.8 m) beams were pretensioned on the warehouse floor. Courtesy: Paul Zia.

twenty-one 5/16-in. (8 mm) diameter stress-relieved seven-wire strand having a total design prestressing force of 176,400 lb (785 kN).

The beams were cast on the finished floor slab of the warehouse. Three pairs of abutments were placed on each side of the building and set directly against the 6-in. (152 mm) thick floor. These abutments were used to anchor the pretensioned strands. Temporary backfill was employed to prevent any possible overturning of the abutments due to the pull in the strands. The anchorage of each strand was achieved by clamps.

Two 30-ton hydraulic jacks, inserted between the abutments and a jacking beam, were used to tension each pair of strands. Only one set of wood forms were used which were stripped and re-used 24 hrs after the concrete was cast. The beams were cured under wet burlap. When the concrete was 3 days old and the average cylinder strength had reached 4000 psi (27,560 kPa), the strands were released. No slippage between the concrete and the strands was observed.

A crew of four established a production rate of one beam every 3 days. When the first five of the eleven beams

were completed, they were lifted at both ends by two cranes and placed on the load-bearing walls in order to vacate the floor space for casting the second group of six beams. A crew of seven did the erection.

Despite the fact that one of the beams was damaged during erection (see Reference 1), the job proved to be successful and the prestressed beams performed satisfactorily.

While the Belle Glade and Sarasota projects were modest in size and the construction methods crude by today's standards, they set in motion the possibilities for plant produced pretensioned concrete.

Plant Produced Pretensioned Concrete

Based on the success of the Belle Glade housing project, the Sarasota warehouse job and other experiences, I became convinced that mass produced pretensioned components manufactured under properly controlled plant conditions (in contrast to random site conditions) would hold a competitive place in the building market. I discussed these

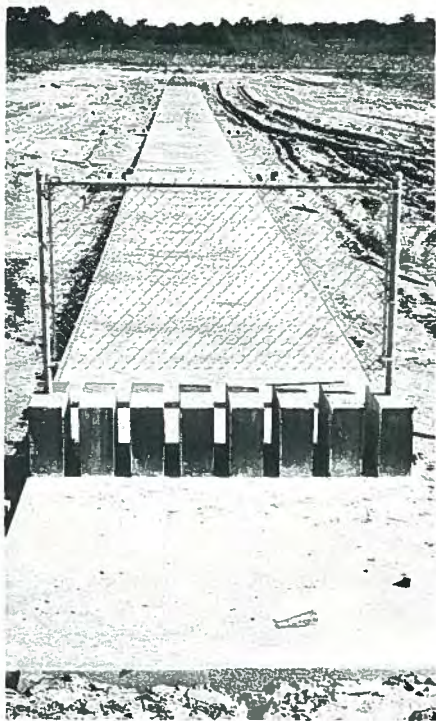

Fig. 3. First prestressing bed built by Florida Prestressed Concrete Co., Inc., in 1953, in Tampa (Courtesy: Paul Zia).

possibilities with key Florida producers of concrete ready-mix and block companies and encouraged them to enter this new business.

Such a venture, of course, would involve substantial outlays in capital for expansion of plant facilities, purchase of equipment, machinery, lifting devices, materials, and other hardware. Much of this hardware was still in a developmental stage or simply non-existent. There also was the question of obtaining knowledgeable plant personnel and skilled labor. Lastly, there were many unknown technological problems related to the precasting and prestressing operations themselves that needed solution.

*Capital Prestress in Jacksonville and Southern Prestress in Pensacola were established a few years later.

Nevertheless, despite the above uncertainties, a few courageous and astute businessmen had the foresight to realize that prestressing could benefit their existing operations. They were, of course, aware that there was already an increasing demand for longer span buildings and bridges and that there was a span limit beyond which conventional reinforced concrete would become uneconomical. Being astute businessmen they could well appreciate a new technique which could cut member thickness and weight and reduce steel requirements, thus making their products more competitive with other building materials.

The five business men that did make momentous decisions in 1953-54 to enter their companies into the prestressing business* were:

- Francis Pipkin, representing Gordon Bros., Lakeland, Florida (name later changed to Prestressed Concrete, Inc.).
- Douglas P. Cone, representing Cone Brothers, Tampa, Florida (name later changed to Florida Prestressed, Inc.).
- Sam Johnson, representing West Coast Shell Corporation, Sarasota, Florida.
- George Ford, representing R. H. Wright & Co., Fort Lauderdale, Florida (company later sold to Houdaille-Duval-Wright Company).
- J. Ashton Gray, representing Dura-concrete, Leesburg, Florida (name later changed to Dura-Stress).

One of the first decisions the pre-caster faced was the design of the long-line casting beds. This permitted the pretensioning of strand in lengths of say 400 ft or more so that a large number of concrete components could be cast end-to-end down the full length of the casting bed. The decision depended on many factors, one of which was standardization (covered in the next section). One danger, of course, because of the rapidly changing state-of-the-art, was obsolescence of the casting bed.

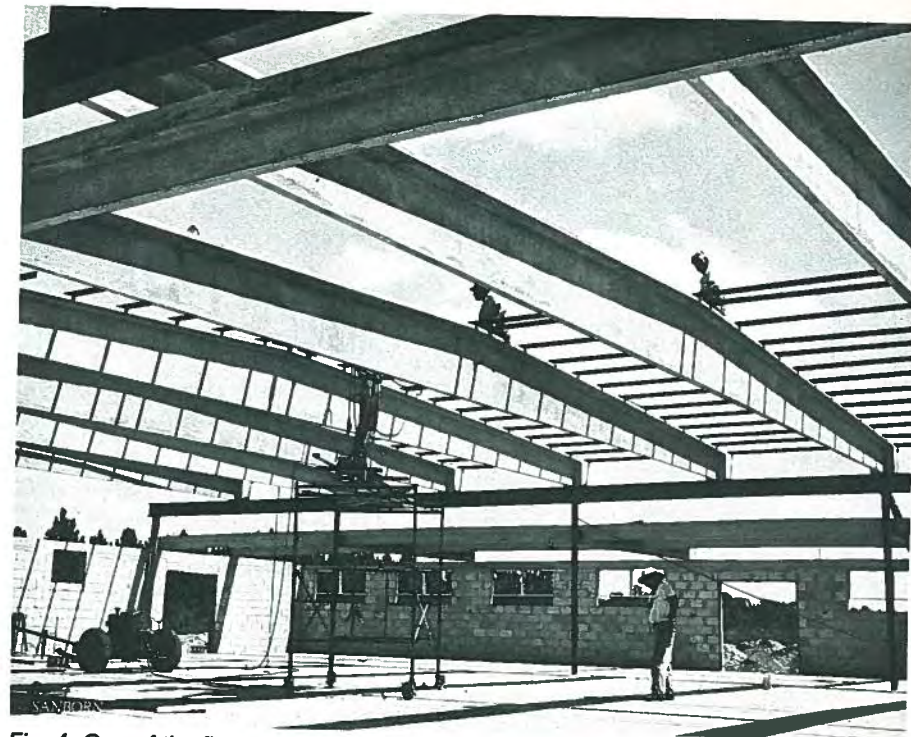

Fig. 4. One of the first examples of pretensioned tapered beams built in Florida in the mid-fifties. These 60-ft (18.3 m) beams were fabricated by Prestressed Concrete Inc., in Lakeland.

Fig. 3 shows the first prestressing bed built in 1953 by Florida Prestressed Concrete Co., Inc. (owned by Douglas P. Cone) in Tampa.

Standardized Cross Sections

Early in the design of the precasting plants, a major question arose, namely, what type of pretensioned element should be produced and what should the cross-sectional dimensions be. Of course, for the precasting operation to be economical, it was essential that some form of standardization be instituted so that mass production would be possible.

From a design engineer's viewpoint standardization meant design simplifica-

tion and an opportunity for any contractor to bid on the same job.

Because of the importance of standardization this whole subject area occupied much of our early activity at Leap. During the first decade we became involved with I-beams, solid flat slabs, double-tees, channel slabs, hollow-core slabs, composite members, tee joists, keystone joists, bridge deck slabs, piles and poles.

Tapered I-beams

One of the earliest examples of pretensioned beams in Florida was for the roof of a ballroom club (see Fig. 4). These 60-ft (18.3 m) tapered beams were fabricated by Prestressed Concrete Inc. (Leap franchised), in Lakeland, Florida.

Another major precast job we did was

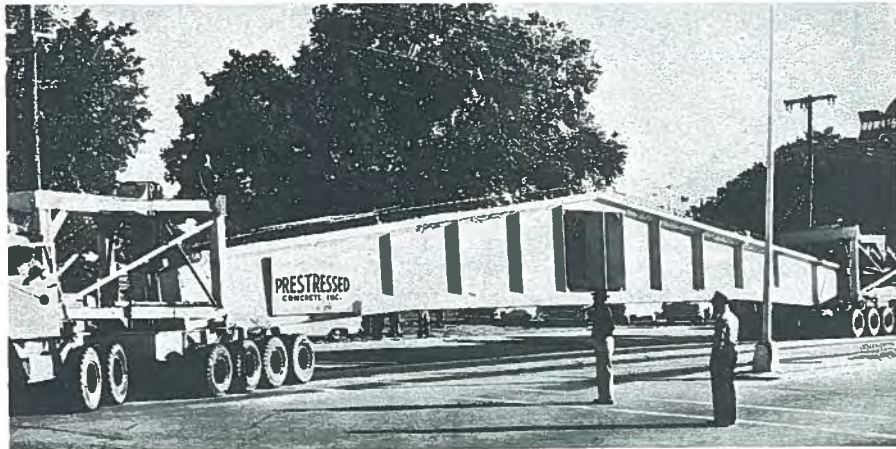

Fig. 5. Pretensioned tapered I-beam with opening and stiffening ribs being transported to American Cyanamid Corp's phosphate plant. Each beam was 101 ft (31 m) long and weighed 71 tons. Beams were fabricated by Prestressed Concrete Inc., in Lakeland (Courtesy, Paul Zia).

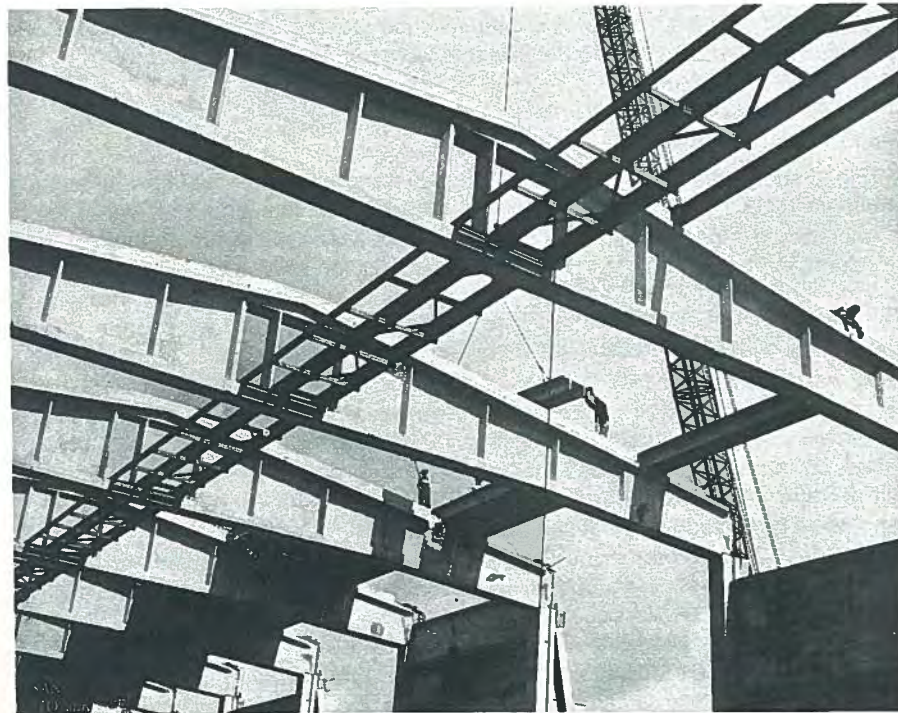

Fig. 6. Pretensioned tapered I-beams being erected at American Cyanamid Corp's phosphate plant. A total of 34 identical beams were used.

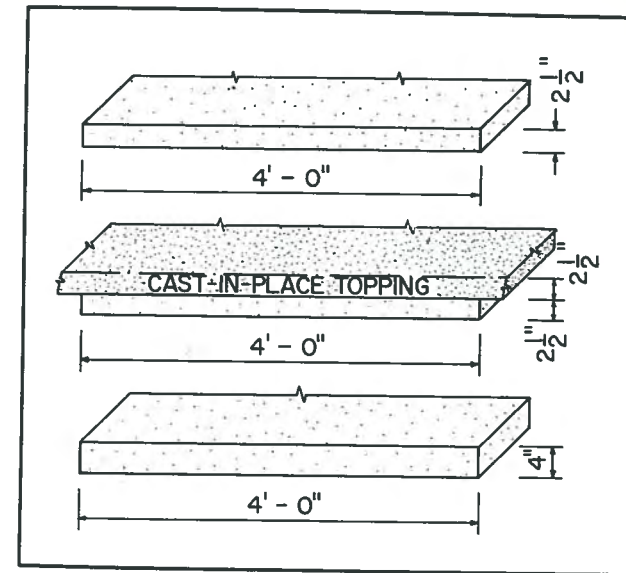

Fig. 7. Typical sections of solid prestressed slabs produced in Florida in fifties. Spans usually ranged up to about 15 ft (4.6 m).

for a phosphate plant owned by American Cyanamid Corporation in Brewster, Florida. This project entailed the design of 34 identical tapered I-beams with an opening at midspan. Each beam was 101 ft (31 m) long, 11 ft (3.4 m) high (at midspan) and 7 ft (2.1) high (at supports), and weighed 71 tons. Fig. 5 shows one of the beams being transported and Fig. 6 shows the beams being erected at the construction site. These beams were fabricated in the

mid-fifties by Prestressed Concrete Inc. (Leap franchised), in Lakeland, Florida.

Flat slabs (Figs. 7 and 8)

The first basic section we considered was the solid slab. The early flat slabs cast were 4 in. (102 mm) thick, 4 ft (1.2 m) wide with spans up to about 15 ft (4.6 m). Sections without cast-in-place toppings were intended for roofs while sections with toppings for composite action were for floors (see Fig. 7).

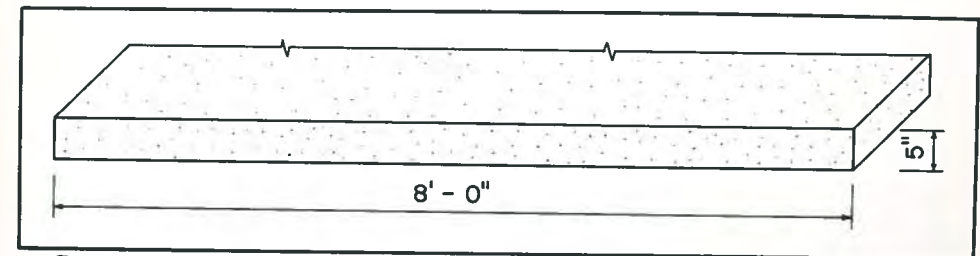

Fig. 8. Cross section of a more advanced prestressed slab produced in Florida. Span lengths went as high as 20 ft (6.1 m). These types of slabs were quite popular in Florida until the advent of the double-tee and tee-joint in the mid-fifties.

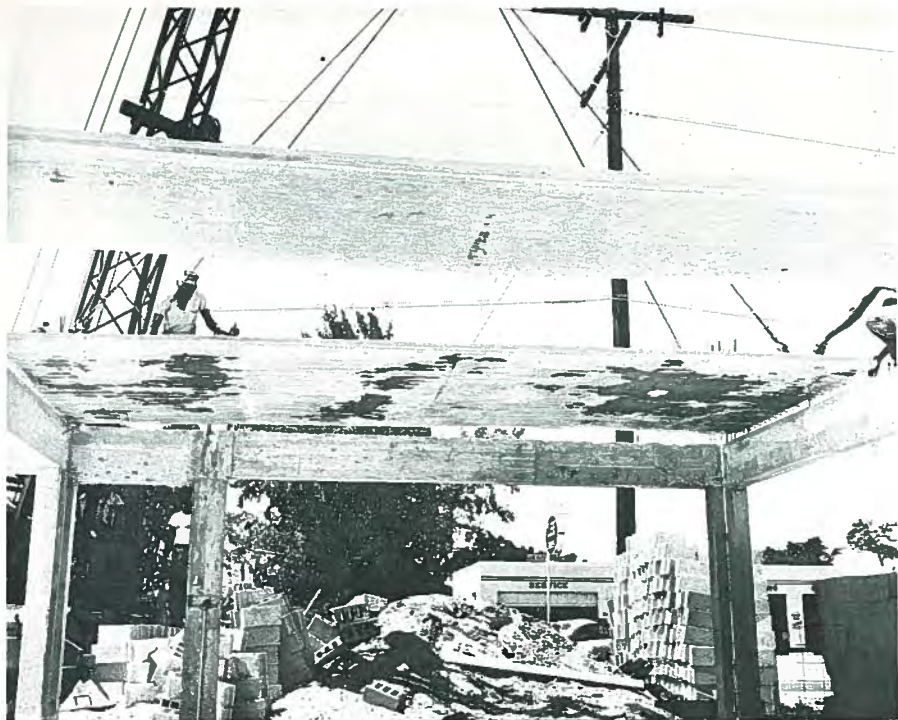

Fig. 9. Thin precast prestressed flat slabs were very popular in Florida in the mid-fifties. These particular slabs were 5 in. (127 mm) thick and 8 ft (2.44 m) wide with a span of about 20 ft (6.1 m), probably longer than would be allowed by today's codes.

Several other slab thicknesses ranging from 2½ to 8 in. (64 to 203 mm) were tried out. However, the 4 and 5-in. (102 and 127 mm) thick slabs turned out to be the ones having the widest application.

Similarly, the width of the slabs was increased to 5, 8, 10 and 12 ft (1.53, 2.44, 3.05 and 3.66 m), with the 8-ft (2.44 m) width having the widest acceptance (see Fig. 8 on previous page).

Fig. 9 shows some very slender precast prestressed slabs being erected on an early project in Florida.

The demand for floor slabs grew faster than for roof slabs and with the wider and thicker slabs, the floor slab with topping gradually gained acceptance.

Development of double-tee

As the demand for longer spans and more diversified structures grew, we knew we had to search for alternative cross sections. The double-tee was the logical extension of the channel slab or thin shell slab developed earlier. By deepening the stems (or legs), shortening the transverse span but cantilevering the top slab beyond each stem, a very practical and versatile member was created. In contrast to a single-stemmed member, the double-tee had two stems which gave the member better support and stability. The double-tee could readily be handled, stored, transported and conveniently erected. We found out that the cantilever on each side of the stem could be shortened resulting in width flexibility (see Fig. 10).

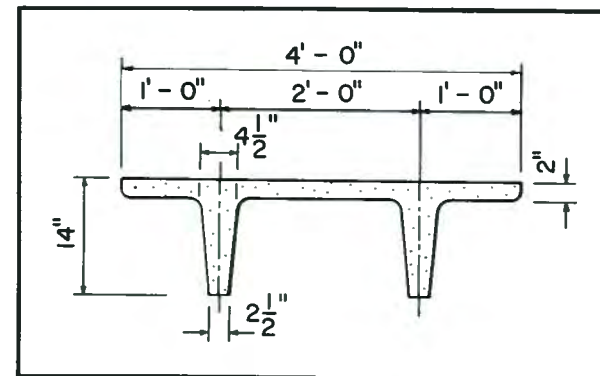

Fig 10. Dimensions of original double-tee.

We also discovered that we could make the section very thin and in fact we got carried away by making it too thin. The slab of our original double-tee was only 1½-in. (38 mm) thick and the stem was 2½-in. (64 mm) wide at the base.

The 2½-in. (64 mm) stem width survived but as soon as we got into production we had to increase the slab thickness to 2 in. (51 mm). This dimension has also survived until today.

The first double-tee which went into

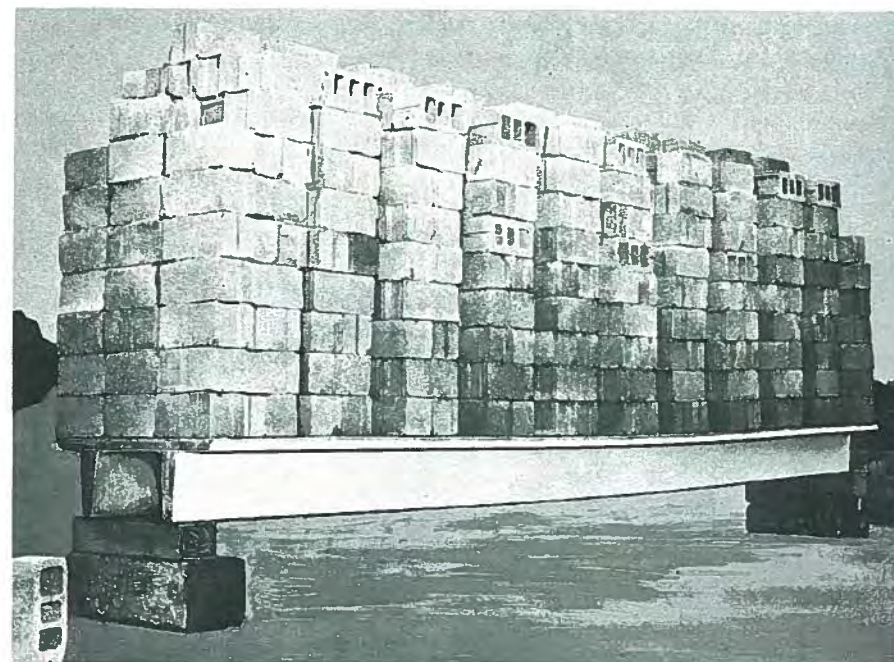

Fig. 11. The first load test on a 14-in. (356 mm) deep, 4-ft (1.2 m) wide and 25-ft (7.6 m) long double-tee. Note the small deflection. Span lengths were later increased to 50 ft (15.3 m).

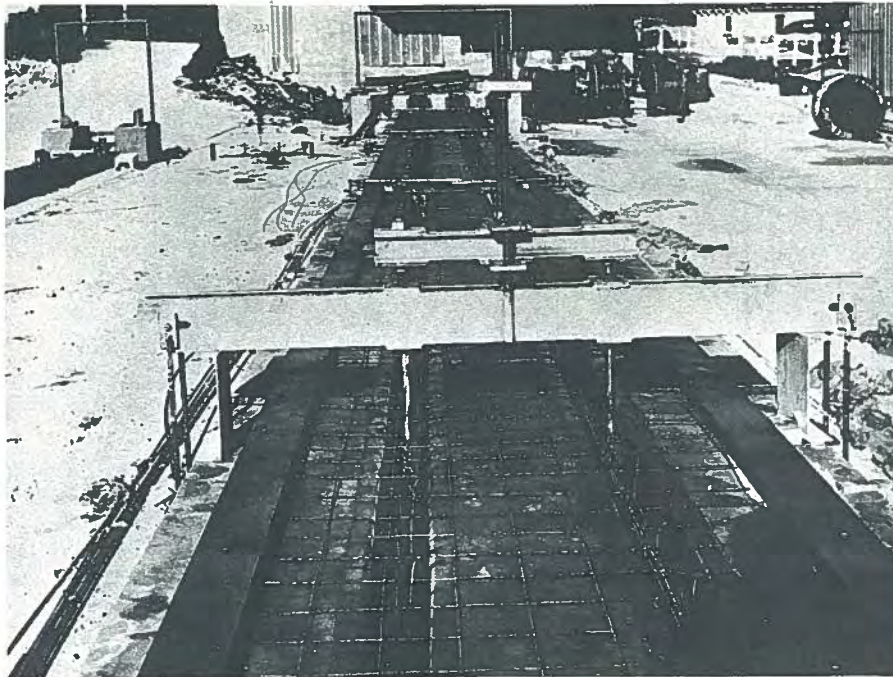

Fig. 12. Early attempt at draping strand in a double-tee. The concrete stressing bed is 420 ft (128 m) long. Note that the stems of the double-tee form had a steel liner. In the background can be seen strand wound on large wood reels. Courtesy: Dura-Stress, Inc., Leesburg, Florida.

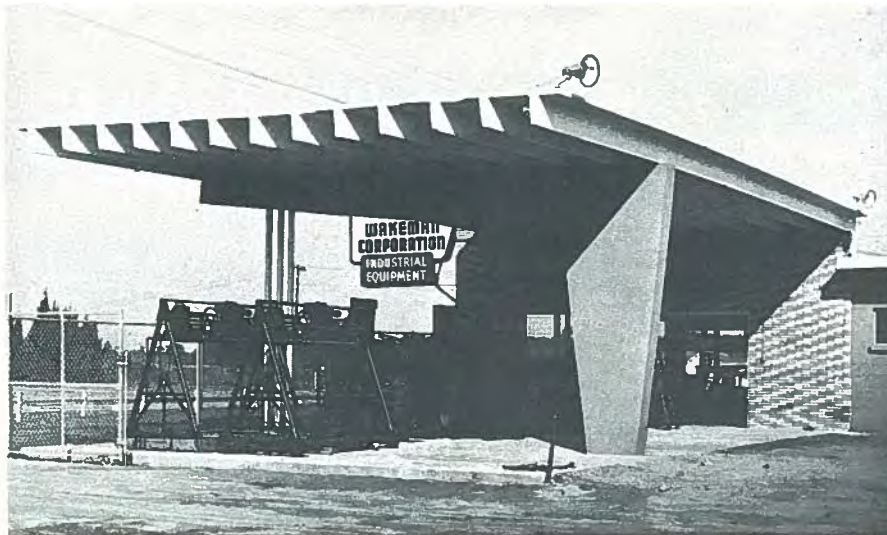

Fig. 13. Application of original double-tee [14-in. (356 mm) deep by 4-ft (1.2 m) wide] for a canopy of an industrial building.

production was 14 in. (356 mm) deep and 4 ft (1.22 m) wide including the two 1-ft (0.305 m) cantilevers (see Fig. 10).

With a slab thickness of 2 in. (51 mm) and stem widths of 2½ and 4½ in. (64 and 114 mm) at the base and top, respectively, these dimensions gave a slope on the side of the stems of 1 in 12—too liberal by today's standards but for those days provided sufficient tolerances for stripping the product from the forms.

The original double-tee is relatively small by today's standards. Nevertheless, its dimensions were largely dictated by the capacity of existing cranes, and span length demands at the time. We also felt it was prudent to start in small steps and thoroughly test the member in the laboratory and the field before going to bigger sections. The first load test on a 14 in. (356 mm) by 4-ft (1.2 m) double-tee member is shown in Fig. 11. As can be seen from the small deflection, the member performed admirably under load (see previous page).

At the start, most plants used parallel ¾-in. (10 mm) diameter 250-ksi (1724 MPa) strand. During the second year and thereafter, two-point depressed strand patterns were used to increase the span and loading range.

Fig. 12 shows an early attempt (1956) at draping strand in a double-tee at the Dura-Stress plant in Leesburg, Florida.

The introduction of the double-tee played a very important role in the development of the young prestressed concrete industry. Within 5 years it was produced in five plants in Florida and about twenty other plants throughout the United States. Span lengths could now be extended to about 50 ft (15.25 m).

The original double tees were used in many diverse types of applications. Fig. 13 shows one such example in an industrial building and Fig. 14 shows another application in a short-span bridge. Later the technique was extended to longer span county bridges (see Figs. 15 and 16). Double-tees were



Fig. 14. Application of 14-in. (356 mm) double-tee for short-span farm-to-market bridge. Several hundreds of these bridges have been in use for over 20 years with excellent performance.

also ideally suited for school buildings which typically were on 24-ft (7.32 m) modules with a central corridor.

One further advantage we found was that with minor modification the forms for double-tees could be converted into other shapes. For example, by eliminating the cantilevers a channel section could be formed. Using this technique, span lengths could also be increased. One such example is shown in Fig. 17.

With the advent of larger capacity cranes and the demand for even longer spans (in the early sixties), the section of the original double-tee was enlarged to that shown in Fig. 18 (a section which is still in use today). We found that by making the slab wider and the stem deeper we could greatly extend our span lengths. The most popular section was an 8-ft (2.44 m) deep member with stems 3¾ in. (95 mm) at the base and 5¾ in. (146 mm) at the top. These dimensions gave a stem taper of 1 in 22. (The form manufacturers by this time were able to furnish a more precise form assembly for easy withdrawal of the product.)

During the developmental period of

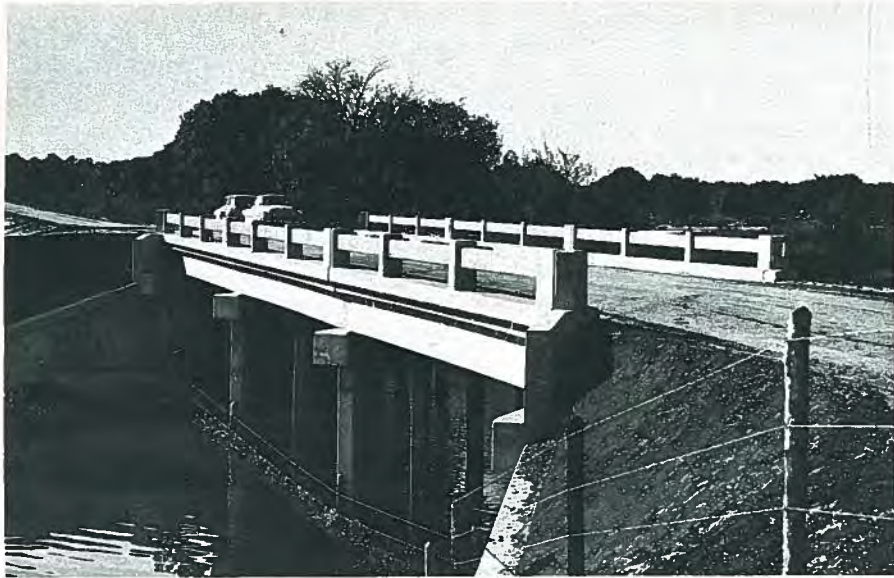

Fig. 15. Precast prestressed county bridge in Sarasota, Florida.
 Courtesy: Paul Zia.

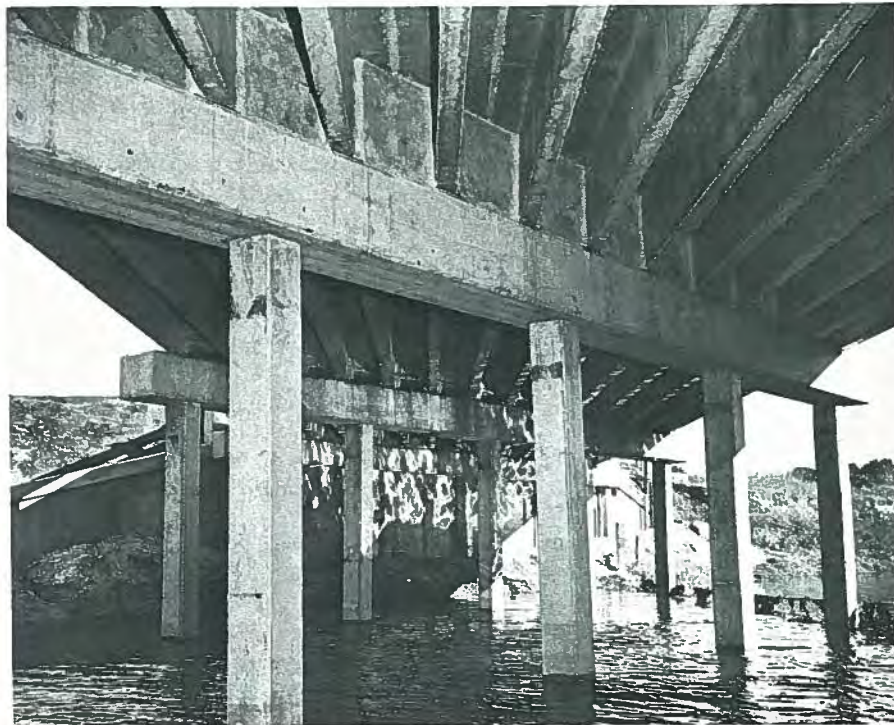

Fig. 16. Underside of precast prestressed county bridge in Sarasota, Florida.
 Courtesy: Paul Zia.

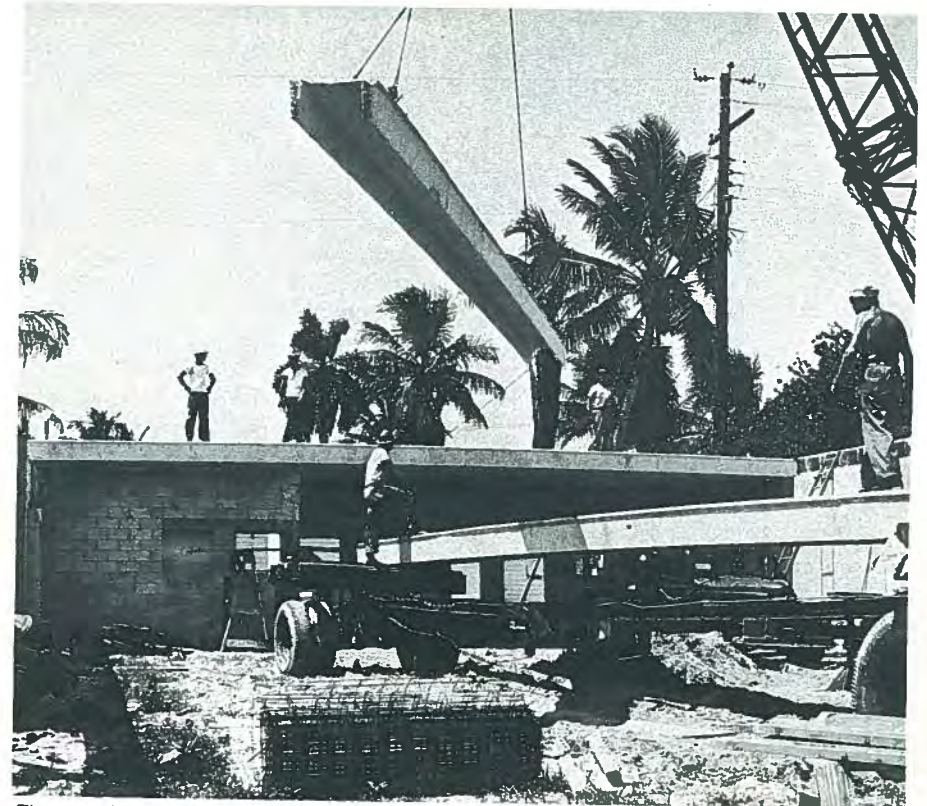

Fig. 17. Original 14-in. (356 mm) deep x 4 ft (1.2 m) wide double-tee reduced in width to a channel section in order to obtain longer spans.

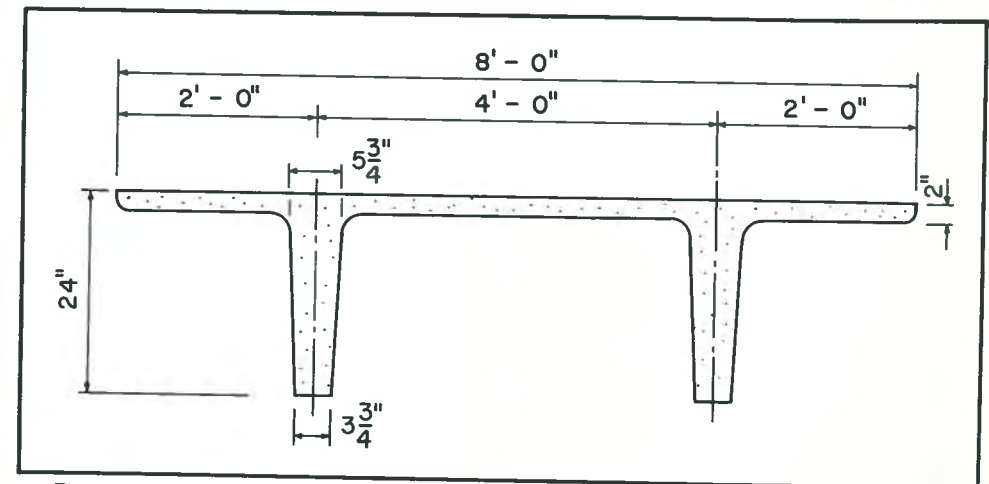

Fig. 18. Dimensions of giant double-tee (late fifties).

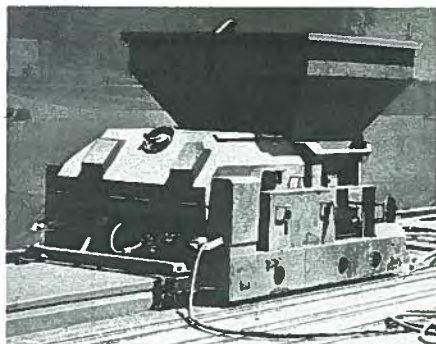

Fig. 19. The Dodd extruder. This machine (although quickly outmoded) was one of the first machines in Florida to produce hollow-core slabs continuously and automatically.

the 4-ft (1.22 m) wide double-tee we made a mistake by producing a 5-ft (1.53 m) wide double-tee which was not a progressive solution so we immediately went to an 8-ft (2.44 m) wide slab. And in doing so, we recognized the limitations on the stem width of the original double-tee. If the stem is too narrow the section becomes very congested and placing of concrete becomes difficult resulting in possible honeycombing. In fact, we were in favor of widening the stem width beyond 4 in. (102 mm) but we were talked out of it and eventually we held it down to 3¾ in. (95 mm).

In retrospect, I wish we had held our ground and gone to stem widths of 4 or 4½ in. (102 or 114 mm). Later experiences showed us that the early double-tees needed more cover for fire protection. Also, with wider stems more parallel strands could be used without making the placing of concrete more difficult. In addition, a more economical design would result as the eccentricity would be increased, provided camber is controlled.

*It is believed that the first use of hollow-core slabs in the United States was by Spancrete. Henry Nagy, currently Chairman of the Board, Spancrete Machinery Corp. in Milwaukee, Wisconsin, modified a German machine and began producing prestressed hollow-core slabs in 1954.

Hollow-core slabs

In the late fifties prestressed hollow-core slabs became quite popular in Florida for short and medium spans.*

Some of the early producers made hollow-core slabs using paper boxes to create the voids. In fact, one enterprising producer (John Brannen of Sarasota, Florida) successfully produced a hollow-core slab by pulling long metal tubes through the forms with a truck in order to slipform the void of the section.

In 1958 David Dodd developed the Dodd extruder (see Fig. 19) which was one of the early machines in Florida for making hollow-core slabs continuously and automatically. Soon, the Dodd extruder became outmoded although it did pave the way for later more efficient machines. During the sixties Spancrete, Span Deck, and Spiroll were a few of the more successful producers of hollow-core slabs.

Tee-joists

The tee-joint came shortly after the development of the double-tee. In fact, it was possible (with some modification) to cast the tee-joint in the same double-tee form. For longer spans a tapered (variable section) tee-joint was also produced.

At one time, the combination of prestressed tee-joists and tectum roof decks (see Fig. 20) became quite popular in Florida and actually outsold the original double-tee. Subsequently, the keystone joist with a composite cast-in-place deck was developed by Prestressed Systems, Inc., Miami, and became a leading floor system in Florida (see Fig. 21). Under the direction of Jack Schilinger (manager of PSI), the company later developed a complete system of production, delivery and field erection for the precast prestressed segment of the contract.

With the advent of the larger sized double-tee sections, the tee-joint became less and less competitive.



Fig. 20. Canopy using prestressed tee-joists and tectum roof deck. At one time in the mid-fifties this roofing system was quite popular in Florida but soon gave way to the double-tee.

Piles and poles

From the early fifties prestressed piles were produced by most of the precasting plants. One of the most common shapes was an 18-in. (457 mm) square section. Fig. 22 shows the casting of such a pile at Dura-Stress, Leesburg, Florida. As the demand increased, piles with circular, hollow and other cross sections were added. About the same time, other special structural members such as poles and rail ties were also produced.

Single-tee

The single-tee came into prominence in the late fifties.* It was being promoted in California and other parts of the country by Prof. T. Y. Lin. The single-tee was structurally a very efficient section, capable of carrying much heavier loads on longer spans than previously used.

Unfortunately, despite its advantages, the single-tee was inclined to become very bulky and heavy when used for relatively long spans, thus requiring strong straddle carriers to be handled by large cranes. Also, because it has a single stem the member is unstable until erected thus requiring temporary lateral supports. Consequently, the single-tee was difficult to store, to ship and its erection was more limited.

Nevertheless, we did look at the single-tee and in fact were able to cast modified single-tees on our double-tee forms. In the ensuing years the single-tee did not prove to be very widely used in Florida.

*The single-tee (also called the Lin tee) was developed by T. Y. Lin and Associates in California in the late fifties. The section was 8 ft (2.44) wide, 36 in. (814 mm) deep and had an 8 in. (203 mm) wide stem. Spans ranged up to 100 ft (30.5 m).

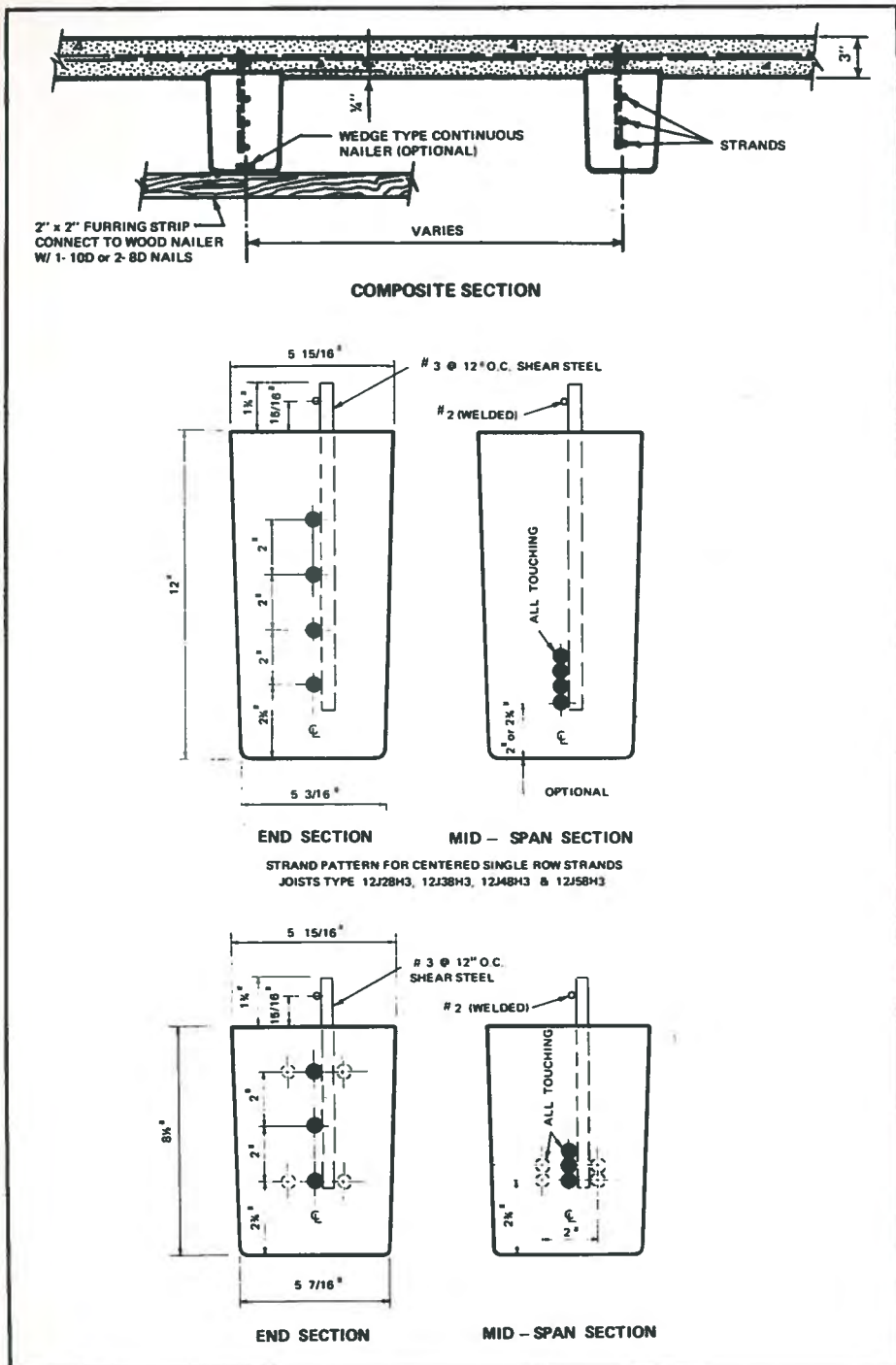

Fig. 21. The keystone joist with a composite cast-in-place deck became in the sixties a leading floor system in Florida. The system was developed by Prestressed Systems, Inc., of Miami, Florida.

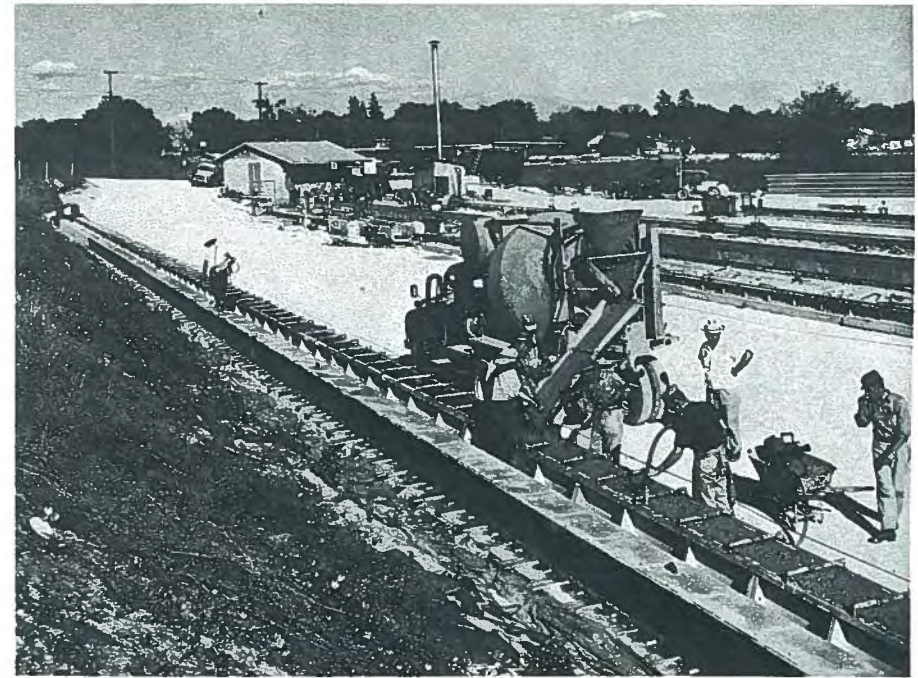

Fig. 22. Early method of casting 18-in. (457 mm) square pile. The bed is 650 ft (198 m). Courtesy: Dura-Stress, Leesburg, Florida.

Some Problems and Solutions

As in any growing business, the pre-casting industry was confronted by some problems. However, these obstacles were gradually overcome through further development, experimentation and engineering judgment.

The following is only a small sampling of the major developments, together with the problems and solutions. Covered are prestressing steel, forms, concrete curing and ponding problems.

Prestressing steel

As mentioned earlier, the development of stress-relieved seven-wire strand played a decisive role in insuring the success of the precast concrete industry. Apart from its superior characteristics, the strand permitted the appli-

cation of a relatively large prestressing force with minimum handling costs.

During the fifties most of the strand in Florida (and indeed around the country) was supplied by John A. Roebling's Sons Corp., the company which pioneered strand development.* The strand performed very well but unfortunately it was packaged on large wood reels which made handling very awkward.

In the sixties most of the strand in Florida was supplied by Florida Wire and Cable Company† in Jacksonville. At first FWC produced only 250-K strand in sizes 5/16, 3/8, 7/16, and 1/2 in. (8, 9.5, 11, and 12.7 mm), packaged on wood reels. Initially, the greatest percentage of strand usage was 7/16 in. (11 mm) diameter.

*Roebling later became a part of the Colorado Fuel and Iron Corporation (CF&I). In 1974 CF&I ceased producing strand.

†FWC was founded in 1958 by Edward Danciger as a Florida Corporation and began manufacturing strand in 1960.

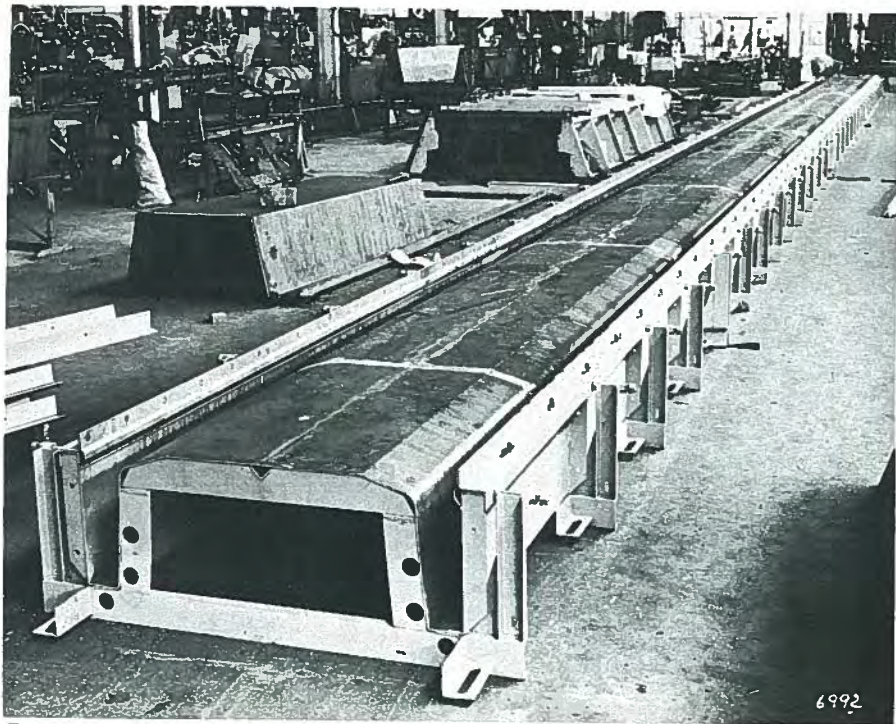

Fig. 23. Typical all-steel form for a channel slab (1957). Courtesy: FMC Corporation, Lakeland, Florida.

During 1962, 270-K strand came into use which was an improvement. About the same time strand began to be packaged in demountable packs and subsequently in reel-less coils replacing wood reels. This innovation made the handling of strand much easier.

Development of forms

The first forms for double-tees were all-concrete molds integrated with the bed. These worked very well for several castings and in fact the concrete surface finish was quite satisfactory. Unfortunately, a careless workman in lowering his spud vibrator into the stems of the tee would nick their sides thus damaging the mold beyond repair. Stripping the double-tee would become increasingly difficult and invariably the mold had to

*Currently, President of Prestress Supply in Lakeland, Florida.

be scrapped. The solution to correct this situation was to encase the stems with a steel liner.

For competitive reasons, double-tees had to be produced on a daily basis. This required accelerated curing. To achieve this, steel pipes through which steam would circulate were embedded in the concrete. This system worked well for a few years until corrosion on the inside of the pipes restricted the flow of steam. In subsequent installations hot water and hot oil circulation were substituted. Eventually, of course, the forms were made entirely of steel.

Much of this developmental work on forms was accomplished by Food Machinery and Chemical Corp. (FMC) and Plant City Steel Co. In fact, in the fifties and sixties most of the steel forms in Florida were supplied by these two companies. Rex Hartup,* who at the

time was sales engineer for FMC, was responsible for many of the innovative developments of steel forms for all types of prestressed concrete products. Fig. 23 shows a typical example (in 1957) of an all-steel form for a channel slab.

Curing plant-produced products

Because of Florida's warm climate, year-round precast production could be carried out without protective enclosures. From the beginning small quantities of calcium chloride were added to the concrete mix as an accelerating admixture. Freshly cast concrete was cured by means of hot water circulating in pipes.

All the early precasters used the above curing method which worked very well and was economical. In fact, hundreds of prestressed concrete structures (in which calcium chloride had been used) are still in existence today without showing any detrimental effects. Unfortunately, during the mid-fifties calcium chloride was being used in Western Canada (and other areas) in conjunction with an imported oil-tempered non-stress-relieved prestressing steel. It is further believed that in some cases concrete with a fairly high water-cement ratio was also being employed. As a result, corrosion failures occurred in several prestressed concrete structures.

The steel manufacturers and other research teams made a thorough investigation of the failures and concluded that it was the calcium chloride that was causing the steel corrosion.* The investigators were probably right for that type of steel, the amounts of calcium chloride used and other field conditions. It is also possible that the relatively high water content in the concrete mix may have contributed to the steel corrosion.

At any rate, these failure incidents received a tremendous amount of publicity world-wide. It came to the point where no reputable engineer would specify calcium chloride as an admixture in pre-

stressed concrete and eventually it was banned from all codes of practice.

Precasting plants had to look for other methods to accelerate curing of concrete. As a consequence steam curing and circulating hot oil were introduced which proved to be quite expensive except that they allowed for more efficient daily production cycles.

Ponding problems

During the late fifties and sixties there was a tendency to "stretch" the spans of prestressed roof members. This was accomplished through the use of depressed strands which at the same time reduced camber due to the prestressing forces.

In selecting the location of the deflectors and the number of strands to be deflected, the designer could control the magnitude of the camber. If the camber was too small, either by design or due to carelessness, the final condition of prestress plus dead and live load could result in *deflection* rather than camber.

As a result, if after a rain there was not a complete water run-off, the deflection would increase and cause "ponding." This condition would worsen with each subsequent rainstorm as water would keep accumulating on the roof.

This so-called "ponding" problem did result in several failures which were widely publicized across the country. The solution, of course, was to take into consideration *all design criteria* and provide *adequate camber* in a roof member. In addition, the roof itself should slope slightly to provide for water drainage. The ponding problem was ultimately solved but for some years it caused much grief and needless anguish.

*For more detailed information on this subject see the articles: "Use of Calcium Chloride in Prestressed Concrete," by R. H. Evans, *Proceedings, World Conference on Prestressed Concrete, San Francisco, California, July 1957*, pp. A31-1-8; and "Corrosion of Prestressed Wire in Concrete," by G. E. Monfere and G. J. Verbeck, *ACI Journal, Proceedings V.57, No. 5, November 1960*, pp. 491-515.

Part 3 (cont.)

The Innovators of Prestressed Concrete in Florida



Harry Edwards

President
Leap Associates, Inc.
Lakeland, Florida

The key to the success of the prestressed concrete industry lay in developing a high quality, well-engineered, competitive product.

In the last issue I described how the precast prestressed concrete industry got started in Florida. In particular, I discussed the development of design specifications for prestressed concrete, the establishment of the first precasting plants, the evolution of standardized cross sections, several early applications of pretensioned products and some of the problems and solutions.

While much of this activity was going on, several other significant developments were being actively pursued:

- Full scale load demonstration tests of the newly developed products at the precasting plants.
- The formation of the Prestressed Concrete Institute (and its initial programs) and the Florida Prestressed Concrete Association.
- Various educational activities, especially the research programs at the University of Florida and the Leap conferences.

In the following narrative, I will discuss in some detail each of the above developments.

Continuing from the previous issue, the author reflects upon the beginnings of the precast prestressed concrete industry in Florida. He describes the field demonstration tests, the formation of the Prestressed Concrete Institute, the Leap conferences and the contributions by the University of Florida.

Load Testing Demonstrations

With the introduction of each new section it became highly desirable to test the performance of the product. After all, most engineers and state officials were unaware of the capabilities of prestressed concrete. The early precasting companies would put on load demonstration tests at which they would invite key building officials, state and local highway department personnel, architects, consulting engineers, builders, producers, the press, and other interested persons.

It was important to instill upon building code and highway officials (and thereby the public) a high degree of confidence in the product. These demonstration tests were performed on bridge deck slabs, channel slabs, double-tees, tee-joists, piles, composite members, and other products (see Figs. 24-33). By and large these spectacular tests were highly successful and made a lasting impression on the spectators.

Indeed, it was at one of these early demonstration tests in 1953 at Cone Brothers (Florida Prestressed Concrete Co.) in Tampa that I first met Bill Dean, then a bridge engineer with the Florida State Highway Department in Tallahassee. Dean had earlier designed the Tampa Bay Bridge and was well acquainted with prestressed concrete construction. He was, however, primarily interested in post-tensioning but was insatiably interested (and open-minded) in any new technique that would produce a more economical and better-engineered structure.

It was at this demonstration test (and others that followed) that Dean became even more convinced that pretensioned concrete was a viable construction material in highway work. From the load tests on 8-in. (203 mm) thick bridge deck slabs (at which Dean was present) two things became apparent: (1) that a prestressed member could carry a much greater load prior to failure than a comparable reinforced member and (2) that even just prior to failure if the load were removed, the member would recover its

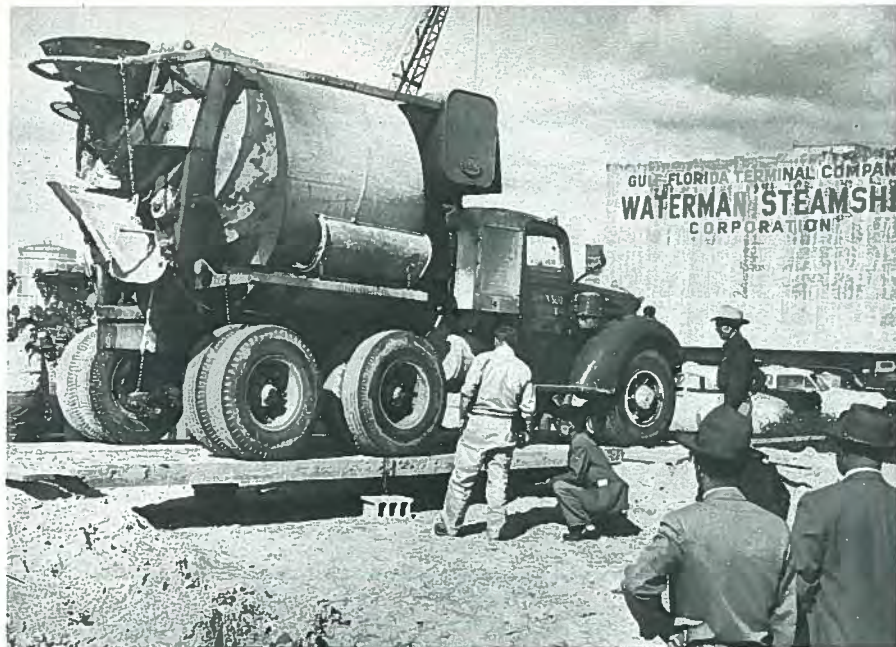

Fig. 24. Demonstration test by Cone Brothers Construction Co. in Tampa, Florida (1954) of 2-in. (51 mm) thick prestressed slab with 4-in. (102 mm) composite topping. The span was 30 ft (9.2 m) long.



Fig. 25. Demonstration test of 100-ft (30.5 m) long prestressed channel slab at R. H. Wright & Son, Fort Lauderdale, Florida.



Fig. 26. Demonstration test of prestressed I-beam at Cone Brothers Construction Co., Tampa, Florida. In foreground is a variable depth tee-joint. Courtesy: Paul Zia.

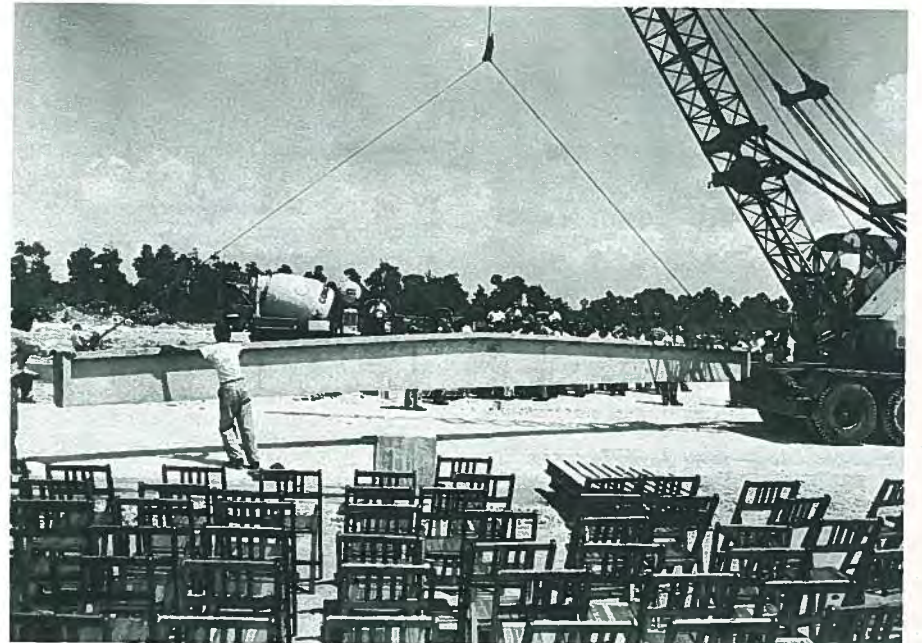

Fig. 27. Variable section tee-joint being lifted by crane prior to testing at Cone Brothers Construction Co., Tampa, Florida.

MAGIC OR

REALITY

By Col. Martin P. KORN
Executive Secretary
Prestressed Concrete Institute

Dramatic Demonstration of Prestressing Amazes Spectators At Beam Test

Test described conducted by Prof.
A. M. Ozell, College of Engineering,
University of Florida, Gainesville,
Florida

It happened near Jupiter, Florida, not too many months ago when Juno Prestressors put on a show. A beam was to be tested. Was that the only attraction . . . just a test?

A beam is a beam and there is nothing new in that! But this test was to be different, for many were curious, or skeptical, or both. And so they came — architects, engineers, contractors and builders.

The beam was a 14" prestressed concrete channel section, 2'-6" wide, 63'-0" long, original camber plus 4", design live load 30 lbs. per sq. ft. The beam was loaded with one live load and down went the beam, the camber reduced to plus 1½".

A second live load was added and down went the beam again, now registering a deflection of -1½". The beam, loaded with 60 lbs. per sq. ft., had gone down 5½" at its center seemingly like rubber, not a crack in sight. Curiosity was ripe.

What if a third live load were added? Would they dare? Any beam of steel or reinforced concrete would hardly be expected to look happy under two live loads. Certainly not reinforced concrete which would surely show cracks. But three live loads — was not that asking too much of prestressed concrete?

The producer did not think so nor was he backing away from a challenge. So the

word was passed around that a third live load would be added. And the loading began.

Cement blocks one after another distributed symmetrically, went to work, the beam went down and down, an inch, and another inch; finally more than one foot. The crowd stepped back. What if the beam collapsed? Anything could happen. Everyone seemed primed for the climactic moment — a drama of stress and strain and then . . . !

Silence, suspense, anxiety! Breathing seemingly stopped. The third live load was completed. Nothing was happening. The beam held fast, the audience with it. A pause and then the group moved close; some cracks had appeared, they were hardly more than hairlines.

Deflection now registered -9", a drop of 13" at center of beam! Talk about rubber, here was prestressed concrete, a structural material, load bearing and certainly putting on a show of strength, its muscles flexed under a live load of 90 lbs. per sq. ft., three times its design load! Now what did the spectators think?

Granted the beam was strong. But just because it stood up under three live loads like rubber didn't mean it was good any longer, or was it?

One live load was removed and the beam

recovered from a -9" deflection to 2¼".

A second live load was removed and the beam moved up to show a camber of plus 1½". What now?

The third and last live load was removed and the beam seemed to bounce up in victory — its camber restored to plus 3¼". Surprise and thrills reflected in the expressions of the spectators. Not a crack was visible. All had disappeared. Recovery was almost complete. A permanent drop of a mere ¾" after that herculean display of strength and resiliency. Was it reality or magic in that prestressed concrete?

Reality, as attested by numerous similar tests of varying types of prestressed concrete products around the country. A reinforced concrete beam could not have made it if only 14" deep. Not even a steel beam. Here then was something for the architects, engineers, contractors and builders to ponder.

Prestressed concrete has strength, but it has something more. It had resiliency greater than reinforced concrete or even structural steel, a natural for dynamic loadings. It spells economy in costs, no maintenance, savings in headroom by virtue of its shallower depths. It is available for quick delivery and erection. It offers versatility. Yes, the magic of prestressed concrete is now a reality.

This article was originally published in the

FLORIDA BUILDING JOURNAL, Feb. 1958

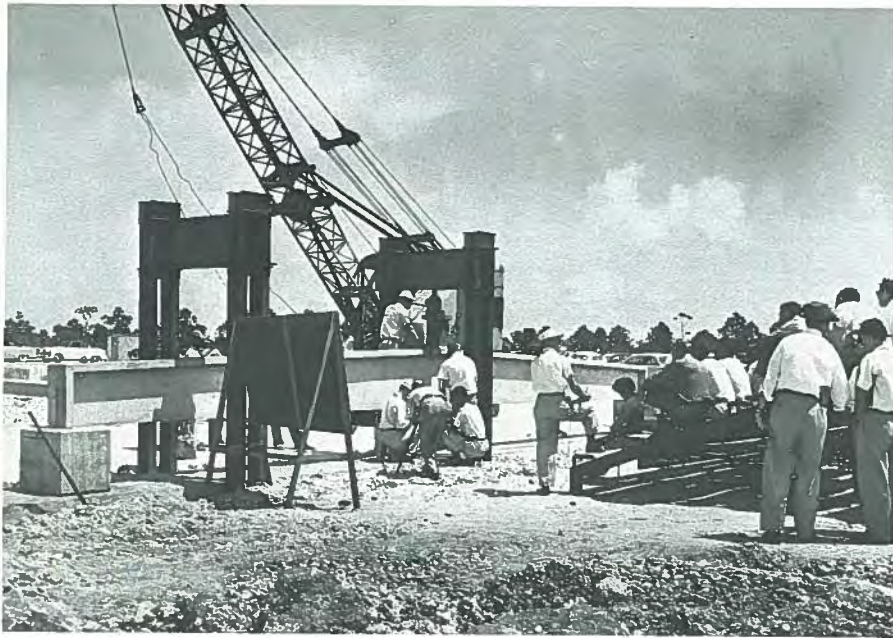

Fig. 28. Demonstration test of variable section tee-joint at Cone Brothers Construction Co., Tampa, Florida. Courtesy: Paul Zia.



Fig. 29. Demonstrating the production of a 14-in. (356 mm) deep by 4-ft. (1.2 m) wide double-tee at R. H. Wright & Co., Fort Lauderdale, Florida. Note that this form used a steel liner for the stems only. The remainder of the form was concrete.

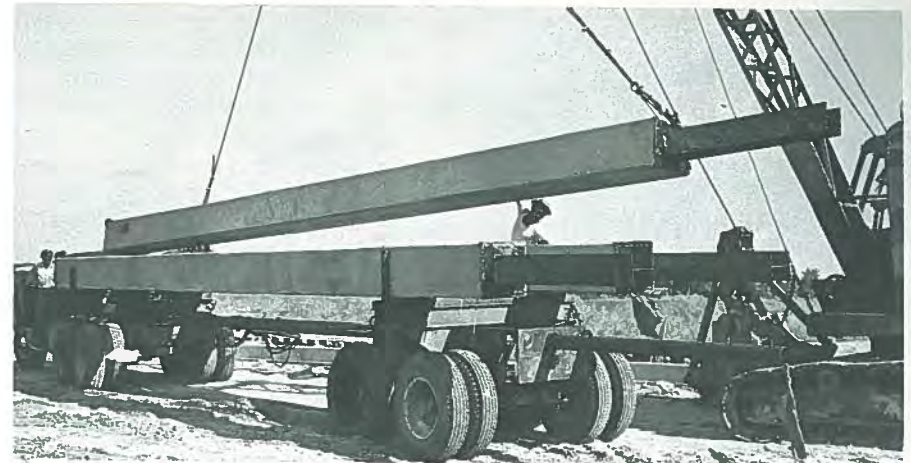

Fig. 30. A pretensioned pile (with wide flange steel beam used for rock penetration) being transported to field demonstration test site.



Fig. 31. Pile driving demonstration test at Cone Brothers Construction Co.

**TAMPA SAND &
MATERIAL CO.**

and
**CONE BROTHERS
CONTRACTING COMPANY**

Welcome You
to a

**DEMONSTRATION &
TESTING
of
PRESTRESSED CONCRETE
STRUCTURAL MEMBERS**

Tampa, Florida
December 16, 1953

All members to be tested today were designed by Lakeland Engineering Associates, Inc., Lakeland, Florida, under the direction of Harry Edwards.

The purpose of this demonstration is to acquaint the engineers, architects, public construction officials, and other interested parties with the uses and advantages of building with Prestressed Concrete.

We sincerely appreciate your attendance, and if, during the course of events, you have any questions, please feel free to ask them.

Moderator: Mr. Harry Edwards,
Registered Engineer of
Lakeland Engineering
Associates,
Incorporated

Coca Cola, coffee, and water are available to quench your thirst. At noon delicious barbecued chickens and ribs will be served.

Typical announcement of field demonstration test (1953).

deflection and return to its original shape. This power of elastic resiliency, an inherent characteristic of prestressed concrete, greatly impressed Dean as well as many other engineers. Any flexural crack would close after removal of the load, as long as the member remained within the elastic range which is much greater with high strength steels than with ordinary reinforcing steel.

Equally persuasive were the piling demonstration tests (see Figs. 30-32) many of which Dean witnessed. A prestressed pile could be handled easily with a sling around it, dropped right into place in the leads, and driven into the ground without fear of breakage. This was in direct contrast with conventionally reinforced piles which had to be handled carefully because they could get cracked easily during transportation or driving.

The prestressed pile demonstration also showed the importance of keeping the right amount of prestress in the member otherwise rebound shock waves during the driving would crack the concrete.

Thereafter, Dean used pretensioned members in most of the bridges and other structures under the jurisdiction of the Florida State Highway Department. Based on these and other experiences he went on to develop the family of standard piles and I-beams the use of which later spread across the entire country.

On several occasions Bill Dean witnessed testing at the plant of Dura-Stress Inc., in Leesburg, where J. Ashton Gray, did much of the early development work in power and light poles, piles, bridge and building members, and production equipment such as strand depressing devices. When asked recently about some of the early significant developments, Gray said:

"One of the greatest advances came in 1958 when Bill Dean and Red Roberts of the State Road Department came to our yard in Leesburg and we worked out a system of detensioning strands in bridge gird-



Fig. 32. Pile driving demonstration test of series of piles at Cone Brothers Construction Co., Tampa, Florida. Courtesy: Paul Zia.

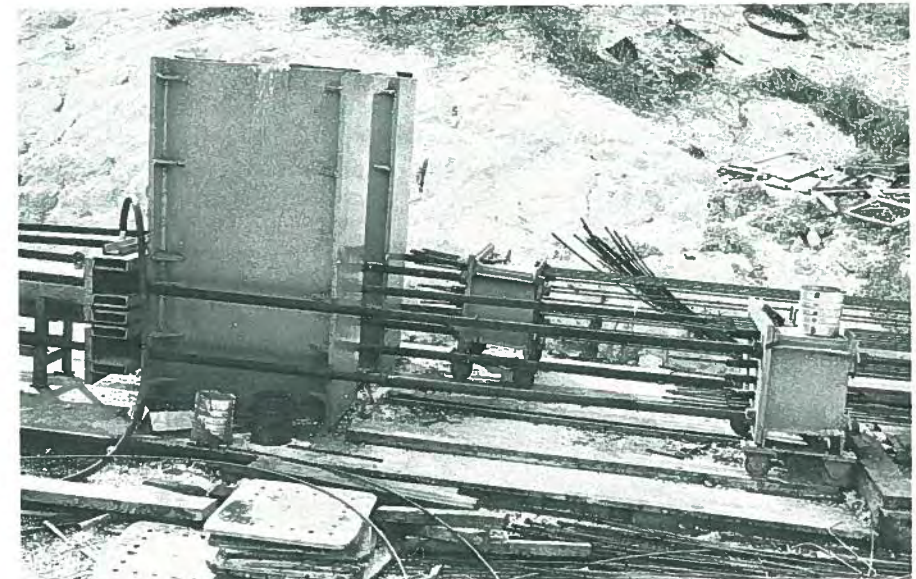

Fig. 33. Early multi-strand tensioning of an 18-in. (457 mm) square pile. Courtesy: Dura-Stress, Inc., Leesburg, Florida.



Douglas P. Cone
(1954-1955)



George Ford
(1955-1956)



J. Ashton Gray
(1956-1957)

First three Presidents of the Prestressed Concrete Institute.

ers by burning the strands in a predetermined pattern simultaneously at a number of points along the long casting bed. Each torch used a low oxygen flame and swept back and forth about 4 to 6 in. (102 to 212 mm) to produce a slower weakening of the steel strand. The detensioning system allowed us to get away from multiple strand tensioning and detensioning using very large rams (200 and 300 tons). As a result, we installed a single strand (center hole) jack."

Fig. 33 (previous page) shows early multi-strand tensioning for an 18-in. (457 mm) square pile at Dura-Stress.

Formation of PCI

As the prestressed industry grew and got larger it became apparent that a central or national organization was essential to give it stature and a unity of purpose. This became especially important if prestressed concrete was going to be recognized (on a par with other building materials) by local, state and national building codes.

At first there was a loose and informal association consisting of the officers of

the first precasting companies. Then through the untiring efforts of Douglas P. Cone, George Ford, J. Ashton Gray and some others, the Prestressed Concrete Institute was legally chartered June 18, 1954, in Tampa, Florida.

Right from the start six classes of members were recognized: Active, for prestressed manufacturers; Associate, for related businesses; Professional, for architects and engineers; Junior, for architects and engineers in training; Student, for students enrolled in accredited architectural and engineering colleges; and Honorary, for such persons as the Board of Directors may wish to honor.

The above shows that from the beginning PCI's founding fathers had the vision to recognize that the newly formed Institute was not simply another "trade association," but that prestressed concrete is an engineered product which needs the active participation of professional engineers.

In retrospect, it was this unique combination of producers, manufacturers of prestressing hardware, machinery and equipment, and professional engineers which sustained the growth and vitality

of the prestressed concrete industry.

The six companies that formed the PCI were Cone Brothers, R. H. Wright & Co., Dura-Stress, West Coast Shell Corporation, Lakeland Engineering Associates and Lakeland Concrete.

The first President of the newly-formed PCI was Douglas P. Cone. Serving as Vice President was George Ford and myself as Secretary-Treasurer. The other Directors were Sam P. Johnson, J. Ashton Gray, Francis L. Pipkin and Frank Williamson.

The initial objectives of the newly formed Institute were to:

- Develop standard specifications for pretensioned products for architects and engineers.
- Conduct full-scale fire tests of roof and floor slab products.
- Develop and promote the standardization of beam sections for bridges.
- Produce a technical journal and newsletter.

In the ensuing years the above goals were attained successfully.

The first annual convention was held at the Lago Mar Hotel in Fort Lauderdale, Florida, April 21-22, 1955. Over 300 engineers, architects, contractors and producers attended this inaugural convention. George Ford was elected PCI President at this convention.

PCI items first appeared in 1955 as a monthly periodical. It was produced by an advertising agency in Fort Lauderdale.

The first issue of the PCI JOURNAL was published in May 1956 (see Fig. 34) under the editorship of Dr. Alan M. Ozell, associate professor of civil engineering at the University of Florida. The new quarterly periodical was displayed at PCI's second annual convention held in Hollywood, Florida, May 16-18, 1956. At this convention, J. Ashton Gray was elected PCI's third President.

It soon became apparent that the PCI needed a permanent headquarters staff.

On Sept. 1, 1956, Col. Martin P. Korn (a former consulting engineer with broad design and construction experience) was appointed PCI Executive Secretary and PCI occupied temporary headquarters in Boca Raton, Florida.

Three years after the formation of PCI, a Florida Prestressed Concrete Association was formed in 1957 principally to develop and promote the interests of Florida precast producers. Sam Johnson of West Coast Shell Corporation was elected first President of the Association. A grouping of some of the early participants is shown on the next page (see Fig. 35).

As the prestressed concrete industry spread nationwide, PCI Headquarters was moved (December 1959) to 205 W. Wacker Drive, Chicago, Illinois, where Norman L. Scott was appointed Executive Secretary.

Prestress Institute Publishes New Journal

A new quarterly technical publication, the *PCI Journal*, made its debut at the recent second annual convention of the Prestressed Concrete Institute held at the Hollywood Beach Hotel in Hollywood, Florida, May 16-18.

A major objective of the Institute since it was organized in 1954, the magazine is under the editorial direction of Dr. A. M. Ozell, associate professor of civil engineering, University of Florida.

The first issue, which was distributed at the convention, contained articles by T. Y. Lin, W. E. Dean, J. C. Rundlett, Paul Zia, R. O. Kasten, A. M. Ozell and J. W. Cochrane, A. R. Anderson, L. E. Hill, Ross H. Bryan, and Lewis E. Weeks.

Fig. 34. News item in Ft. Lauderdale Daily News, June 2, 1956, announcing the creation of the PCI JOURNAL.



Fig. 35. Participants at early meeting of Florida Prestressed Concrete Association. Front row (l-r): Rex Hartup, (unidentified), Bill Newnan, Paul Zia, McKinney Taylor, Francis Pipkin, Jack Plunkett, Harry Edwards, Roy Hill. Back row (l-r): Roy Chastain, Ray Chiodo, Ray McCann, (unidentified), Sam Johnson, (unidentified), (unidentified), J. Ashton Gray, George Ford, John Heald, (unidentified), Harold Price. Many of these gentlemen later went on to serve the PCI and the industry with distinction on the local and national level.

University of Florida Contributions

I would be remiss if I did not acknowledge the considerable help given to the prestressing industry by universities and colleges in Florida and elsewhere.

This assistance came in several forms:

- Conducting fundamental research and valuable laboratory tests on the short-term and long-term behavior of prestressed concrete members.
- Holding seminars and conferences on prestressed concrete and providing the necessary facilities.
- Teaching courses on prestressed

*In recognition of their services to the PCI and the prestressed concrete industry, Professors Kluge, Ozell and Sawyer were made PCI Honorary Members. Professor Zia is a Martin P. Korn Award winner.

concrete to students thereby creating a new generation of engineers.

- Providing technical advice and consulting services.
- Publishing reports and papers.

Considerable research work was done on prestressed concrete during the fifties and sixties at the University of Florida at Gainesville. Much of this research was sponsored by the Florida State Road Department through the initiative of Bill Dean. However, research was also funded by the PCI, the university itself, producer companies and other clients.

In particular, the industry is indebted to Professor Ralph W. Kluge, Dr. Alan M. Ozell, Dr. Donald A. Sawyer, and Professor Paul Zia, who at the time were in the faculty of the Department of Civil Engineering at the University of Florida, for their extremely valuable contributions.*

Leap Conferences

Through the fifties and sixties Leap Associates began having annual conferences for prestressed concrete producers, suppliers to the industry and engineers (see Figs. 36 and 37). These meetings usually lasted 3 days and were heavily attended. The topics at these conferences covered design, production, erection, and sales. Also on the program were problem-and-solution type workshops which contributed greatly to ironing out many of the young industry's problems. In fact, in many ways these early conferences served as the nucleus and proving ground of future PCI Convention workshops and specialized seminars.

Closing Remarks

Thirty years is a long time to have spent in an industry even though it is in one's own chosen profession. Nevertheless, I feel privileged to have had the opportunity to participate in the prestressed concrete industry but particularly to have had the chance to work with



Fig. 36. Prof. T. Y. Lin and Harry Edwards having lunch at one of the early Florida conferences on prestressed concrete (taken at R. H. Wright plant in Fort Lauderdale).

and gain the acquaintance of so many talented construction men and engineers. I have only fond remembrances of the experiences we shared. If there is one aspect of the early days that stands out most vividly in my mind it is the close family kinship, singleness of purpose and the feeling that any problem however difficult could be solved.

In retrospect, I believe the following events and decisions insured the success of the pretensioning industry:

- Unquestionably, the development of stress-relieved seven-wire strand was decisive in making possible the pretensioning industry. Without the strand we could not have accomplished what we did.
- The courage shown by businessmen who wisely invested their money in precasting plants and equipment.
- The recognition that with the demand for longer spans and more diversified structures, a higher quality and better



Fig. 37. Harry Edwards conducting one of the many Florida seminars sponsored by Leap.

Fig. 38. Participants at early Florida prestressed concrete conference at Pier 66, Fort Lauderdale, in early sixties. How many of these gentlemen do you recognize?



engineered product was needed if we were to survive in a competitive market.

- The development of standardized sections, particularly the double-tee for buildings and the I-beam for bridges.
- The close interaction between educators, design engineers, producers, and manufacturers of prestressing hardware and equipment.
- The spectacular demonstration tests which convinced engineers, building and highway officials and thereby the public that prestressed concrete was a viable building material.
- The initiative and influence of Bill Dean.
- The formation of the Prestressed Concrete Institute which gave the young industry a national identity and paved the way in developing design recommendations and specifications

to be included in local and national codes of practice.

Finally, it would be vain of me to claim that it was through any stroke of genius on my part or that of my colleagues that made possible the success of the prestressed concrete industry. Perhaps it was simply because the climate was ripe for prestressing to get started in Florida and that we were lucky enough to be there at the right time!

References

1. Edwards, Harry H., and Zia, Zung-Teh, "Prestressing Provides Spacious Warehouse," *Concrete*, February 1954, pp. 5-7.
2. Edwards, H. H., "Prestressing—A New Age in Concrete," *The Concrete Manufacturer (A Section of Pit and Quarry)*, March 1956, 2 pp.
3. Edwards, H. H., "Standards for the Prestressed Concrete Industry," *PCI JOURNAL*, V. 2, No. 4, March 1958, pp. 77-80.

* * *



Part 4—
Prestressed Concrete
Innovations in
Tennessee

by
Ross H. Bryan

Part 4

Prestressed Concrete Innovations in Tennessee



Ross H. Bryan

Founder
Ross H. Bryan, Inc., Engineers
Nashville, Tennessee

Individual precast prestressed members must be integrated into a structure so that upon completion it has the appearance and structural integrity of a monolithic structure.

Quietly and independently, away from the main hub of construction, some innovative ideas were being implemented with prestressed concrete deep in the State of Tennessee.

This work involved the construction of the first linear prestressed concrete structures (using machine-made block beams) built in the United States, the introduction of continuity in prestressed spans, the first use of deflected strands in pretensioned beams as well as other design and construction innovations.

This paper will describe these developments in some detail and close by discussing some recent research work which might hold promise for the future.

Introduction

I had no knowledge of European developments in prestressed concrete until after World War II, when this work was described by several authors in the technical literature and some engineers returning from the war areas. I did, however, have knowledge of some attempts at structural precasting that had been

Based on his personal experiences, the author describes some innovative uses of prestressed concrete in Tennessee. He recounts the building of the first linear prestressed concrete structures in the United States, the development and use of deflected strand and the introduction of continuous construction.

made in the United States and I became very interested in them—so interested that upon returning from the service I applied to the leading fabricator for a job. I received a polite rejection but this did not dampen my enthusiasm. When I finally became aware of the weight that could be saved by prestressing, I began to think about ways to apply this advantage to precast systems.

Prestressed concrete became a reality in Tennessee when the newly formed consulting firm of Bryan and Dozier began an informal relationship with the Nashville Breeko Block Company in January of 1950, which resulted in the construction of the Fayetteville Stadium and the Madison County Bridge. This relationship would continue for a decade with neither party feeling the necessity of a formal or written agreement.

During this period hundreds of structures were built and many fabricating procedures were developed. Some procedures were improved, some discarded, and some, which were accepted by the industry, are still in use today. It was a relationship in which each party contributed time and/or materials as required to develop a new and exciting method of construction.

Carroll Strohm was General Manager

of the Breeko plant, and his willingness to risk his company's money and reputation in the production of an untried structural product gives testimony to his courage and foresight. The same is true of Ed Rodgers, the young Madison County bridge engineer, and Charles Lindsey, the high school coach at Fayetteville, both of whom literally built their structures with their own hands.

The decade of the fifties was an exciting time for engineers, especially young consultants who were not yet established and had more to gain than lose in the event they chose to develop design and construction skills that older, more established firms preferred to leave to others. It was a time when a designer could establish, in fact had to establish, his own criteria based upon his knowledge and experience—because there were no codes to rely upon.

There were design and construction conferences sponsored by various universities and highway departments during this period. These meetings were usually staffed by the same small nucleus of engineers who at the time were actively engaged in prestressed concrete design. It was a small group with a mutual interest and after the scheduled

The Author

Ross H. Bryan is the founder of Ross H. Bryan Inc., Consulting Engineers, of Nashville, Tennessee. Mr. Bryan designed the first linear prestressed structures to be completed in the United States. He also designed the first structures using deflected, pretensioned strands and developed design procedures for establishing continuity in precast, pretensioned concrete members through the use of mild reinforcing steel.

Mr. Bryan was a member of the PCI Board of Directors in 1959-1960, and Chairman of PCI's Technical Activities Committee from 1960 to 1962. He served as a member of the Fire Test Committee, the PCI Code Committee, the ACI-ASCE Joint Committee on Prestressed Concrete, and the ACI Building Code Committee. Since 1967 his firm has been the inspection agency for PCI's Plant Certification Program.

The author received a BS Degree in Civil Engineering from the University of Kansas in 1933, was employed by the Kansas Highway Bridge Department until 1939, and by the Panama Canal Department until 1942. During World War II he served in the Civil Engineering Corps of the U.S. Navy in the South Pacific.

The firm of Bryan & Dozier was established in 1949 and dissolved in 1952 when each partner set up a private practice. Mr. Bryan then served as president of his firm until his retirement 3 years ago. Currently, he acts as consultant to the firm.

meetings the nights were long and there were many brain-storming sessions. Eventually we would have a code, but this did not come easily. After a number of years a code covering prestressed concrete would be adopted by ACI, but that is another story.

The successful development of a design and construction technique requires input from both field and plant to supplement and confirm the engineering concepts. We were fortunate to have at the Breeko plant two men who shared our enthusiasm for the future of prestressed concrete. Charley Scott was in charge of the prestressing operation, and field problems, of which there were many. Lloyd Markham was the superintendent of the fabricating plant. Both of these men played a significant part in the development of prestressed concrete in Tennessee. Both men are now well known in the industry through their association with Southern Prestressed Concrete Inc. of Pensacola, Florida.

Other authors have described in detail the European contribution to American prestressed concrete design and construction procedures. It is important to remember that the one item required to make prestressed concrete economical in the United States was the production of a high quality tendon that could be bonded without expensive end anchorages. This tendon was developed by Charles Sunderland of the Roebing Company.

To those of us designing in prestressed concrete in the early fifties the Roebing Company was personified by their Sales Manager, Nelson Hicks, and by H. Kent Preston, an engineer assigned to the prestressing strand division. These men played a major role in providing the emerging industry with the research and materials needed to develop new designs and products. They were also very effective in the promotion of prestressed products with clients beyond the reach of most of us.

For several years the Roebing Com-



Fig. 1. Fayetteville Stadium, Nashville, Tennessee.

pany was the only supplier of prestressing strand in the United States. It is indeed unfortunate that the company, which performed the pioneering developmental work on prestressing steel has ceased producing strand.

The Portland Cement Association was very active in promoting prestressed concrete. Their field engineers were well trained and had access to most engineers' and architects' offices. In Tennessee, Henry Dougherty of the PCA office in Memphis became interested in the work we were doing, and was responsible for bringing Ed Rodgers, the County Engineer of Madison County, to our office. This contact resulted in the construction of the first prestressed bridge to be built in the United States of wholly American design and construction procedures.

Fayetteville Stadium

The Madison County Bridge was not the first linear prestressed structure to be built in the United States. The first structure was the Fayetteville Stadium, built on the site by local labor and supervised by the High School Coach, Charles Lindsey. We built a small wooden scale model of the stadium and exhibited it in a number of high schools in the surrounding area.

There was sufficient interest to justify the design and construction of a full scale bleacher section at the Breeko plant. On June 24, 1950, Charles Lindsey viewed the bleacher model at Breeko and on July 13, 1950, we received the go-ahead on the Fayetteville Stadium. On August 28, 1950, construction was begun and the stadium was completed on October 29, 1950. The structure is still in use today (see Fig. 1).

The Fayetteville Stadium was built of post-tensioned concrete block beams spanning 30 ft (9.2 m) between masonry piers. The beam units were three core, 16 x 12 x 8 in. (405 x 305 x 203 mm). Specified strength was 3750 psi (25.8 MPa). The tendons were 0.600 in. (15 mm) diameter galvanized bridge strands, tensioned to 26 kips (116 kN) each. The tendons were not grouted (see Fig. 2). The tendons cost \$14.00 each delivered in Nashville. The completed stadium cost was \$7.65 per seat.

Madison County Bridge

We received the go-ahead on the design of the Madison County Bridge on August 2, 1950. Construction of the beams was begun at the Madison County Highway yard on September 19, 1950. The bridge was completed on October 25, 1950. The bridge beams

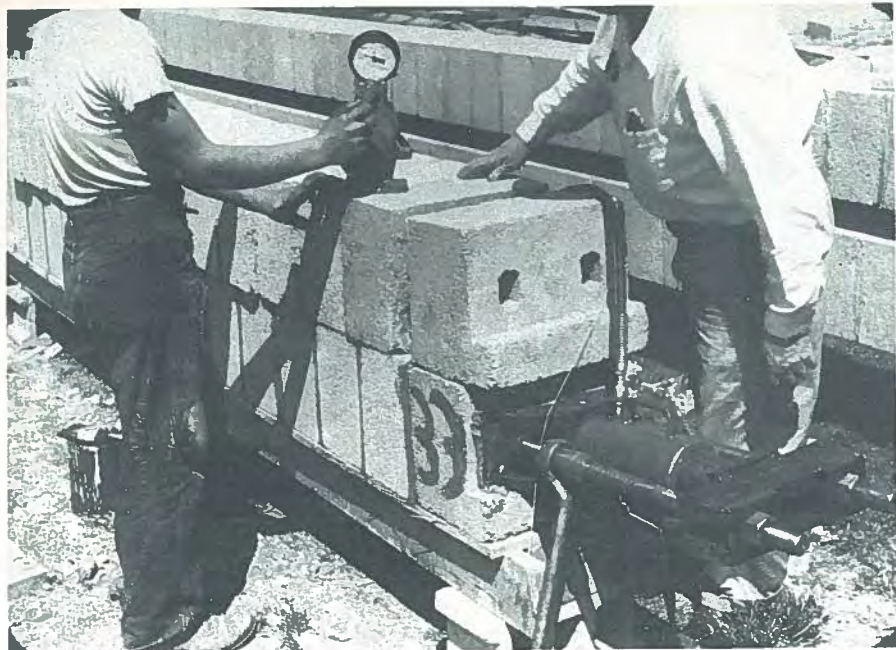

Fig. 2. Tensioning stadium beams.

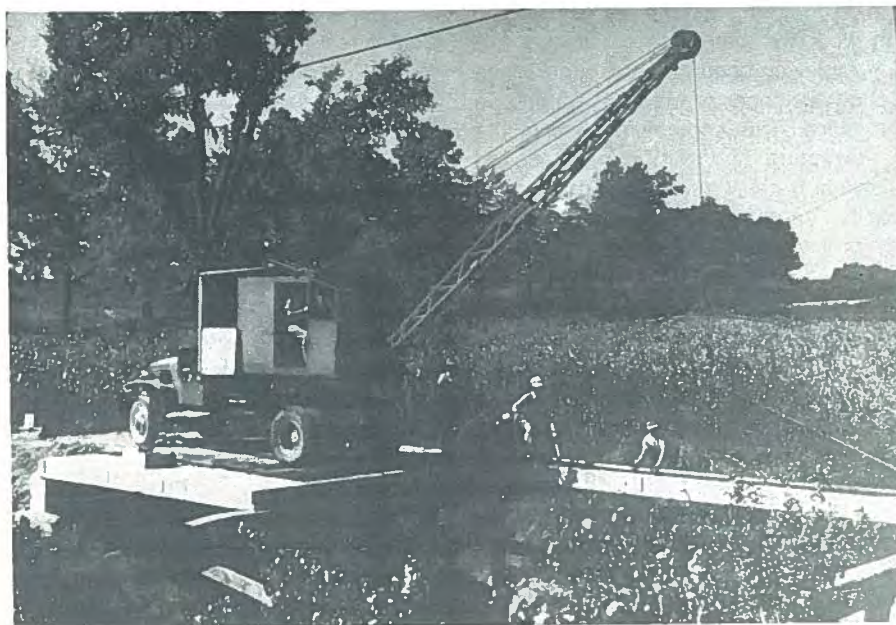

Fig. 3. Setting Madison County Bridge beams.



Fig. 4. Madison County Bridge beam units.

were made from the same units as the stadium except the sides of the unit were brought in to form a keyway when the composite slab was placed.¹

In both the stadium and the bridge, the cores were offset to provide a thickened top flange. The beams were tensioned with the same tendons used on the stadium and were ungrouted. The bridge (see Figs. 3 and 4) is still in service today.

The beam units used in the Madison County Bridge were redesigned for subsequent structures to permit the bonding of the strands and the elimination of fittings at one end by wrapping the tendons around a grooved, reinforced end block.² This reduced the cost and increased the ultimate moment capacity of the beams.³ The new unit also provided a more positive keyway for the distribution of wheel loads (see Figs. 5 and 6).

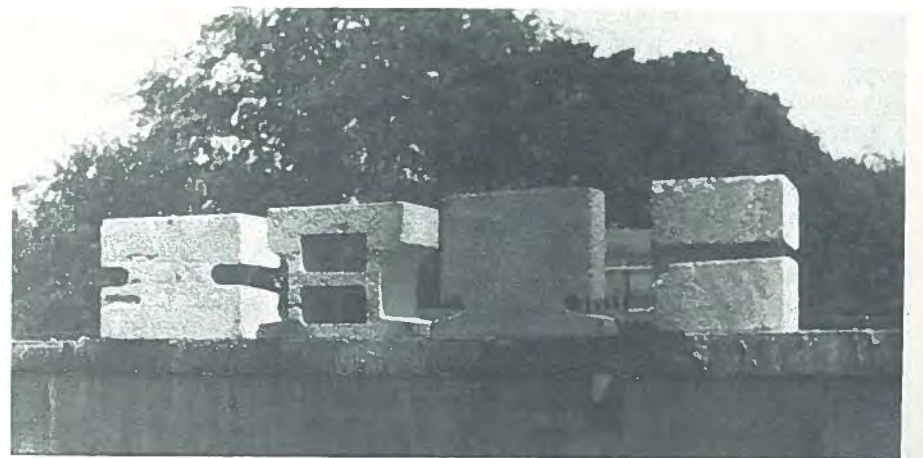

Fig. 5. Redesigned bridge beam units.

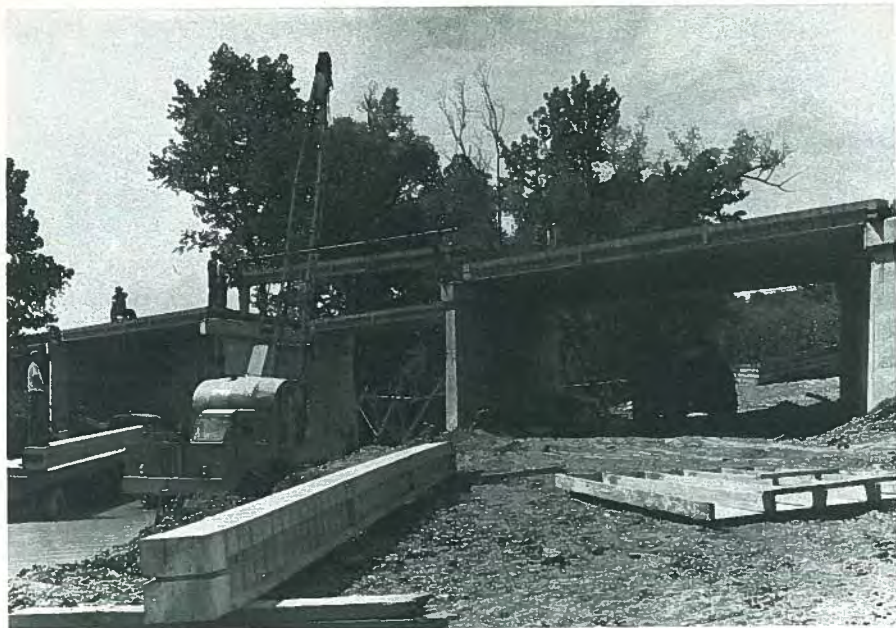

Fig. 6. Bridge beams with bonded wraparound tendons.

Continuous Construction

Beginning early in 1953 all multiple span bridges were made continuous for live load by placing mild reinforcing steel in the topping slab over the interior supports. This also prevented movement of the beams on their supports, which were usually pile bents. Over a period of approximately 5 years more than 50 bridges of this type were built in various parts of the United States and all are still in service today as far as we can determine.

In the early fifties the precast structural systems in general use on buildings included Flexicore, Dox Blocks, and the F&A system. The first two systems used beams, laid side by side, made up of concrete block units reinforced with mild steel bars placed in grooves or in the block cores and grouted to establish bond. The F&A system used precast concrete joists, spaced at 21-in. (53 mm) centers, supporting a machine-made

concrete block filler. A concrete topping, which was cast over this assembly, acted compositely with the precast joist. We attempted to duplicate these systems using prestressed concrete block units.

The first prestressed building floor slab was in the Kroger Store in Nashville. The slab span was 20 ft (6.1 m) and the slabs were supported on post-tensioned, cast-in-place girders, continuous over two 45-ft (13.7 m) spans. The girders were post-tensioned with twelve 1-in. (25.4 mm) diameter bridge strands. The strands were greased and wrapped.

This was the first attempt at continuous construction and we had some problems. It became necessary, due to friction, to tension the tendons from both ends and provisions had been made to tension at only one end. It was finally accomplished after making some special fittings.

The beams spanning between the girders were made of 16 x 8-in. (406 x 203 mm) block units and were prestressed

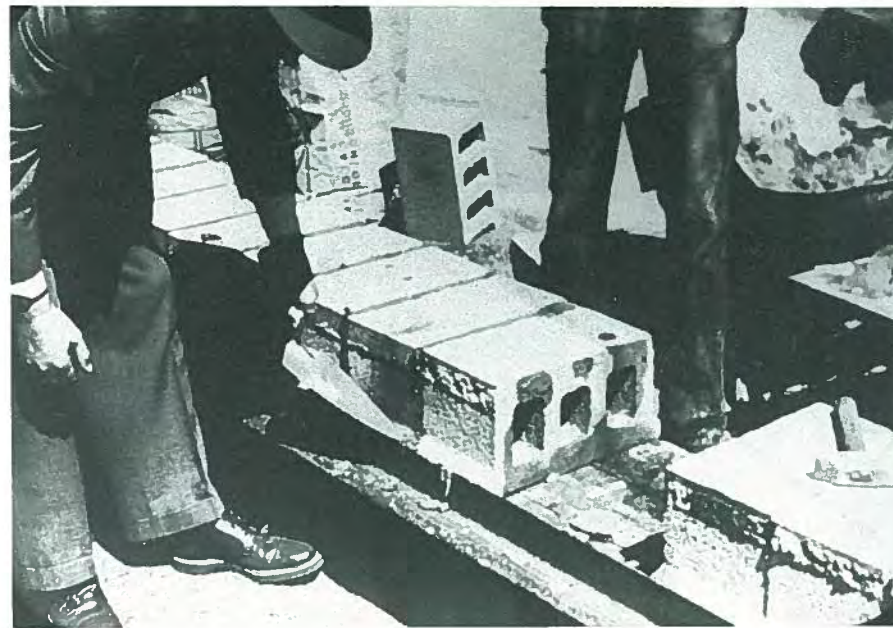

Fig. 7. Fabricating 8-in. (203 mm) block building beam.

with one 0.600-in. (15 mm) diameter galvanized bridge cable in the center core. The beams were similar to the Madison County Bridge beams, having an extended bottom flange which formed a keyway between them (see Fig. 7). A 2-in. (51 mm) concrete topping was placed over the assembly which was assumed to act compositely with both the slabs and the girders. The structure was completed in January 1952 and is still in service.

Deflected Strand

By the time the Kroger Store was completed (1951), we had received information on bond tests run on seven-wire strands indicating that strands up to $\frac{5}{16}$ in. (4 mm) diameter could be bonded in 5000-psi (34.5 MPa) concrete. The block units for building slabs were redesigned to place the cables on the outside of the unit so it could be bonded for ultimate moment. We wrapped the ca-

bles around one end of the beam and anchored them at the opposite end with a spring-loaded aluminum fitting made by the Reliable Electric Company of Chicago.

The anchor was a modified telephone guy wire anchor. The barrel and cap were redesigned for greater loads. The strands were pulled through the anchors and extended about 15 in. (381 mm) to bond into the topping for final anchorage. The strand anchors were seated on cast split washers designed to accommodate the slope of the deflected strand (see Figs. 8 and 9).⁴

Early in 1953 we were assured that seven-wire strands, up to $\frac{3}{8}$ in. (9.5 mm) diameter could be bonded in 5000-psi (34.5 MPa) concrete and our entire design and fabrication procedure for building products was revised. The fittings and the labor of tensioning were a significant part of the total cost of the product. We eliminated the fitting by placing the strands inside the cores of the units and grouting them.

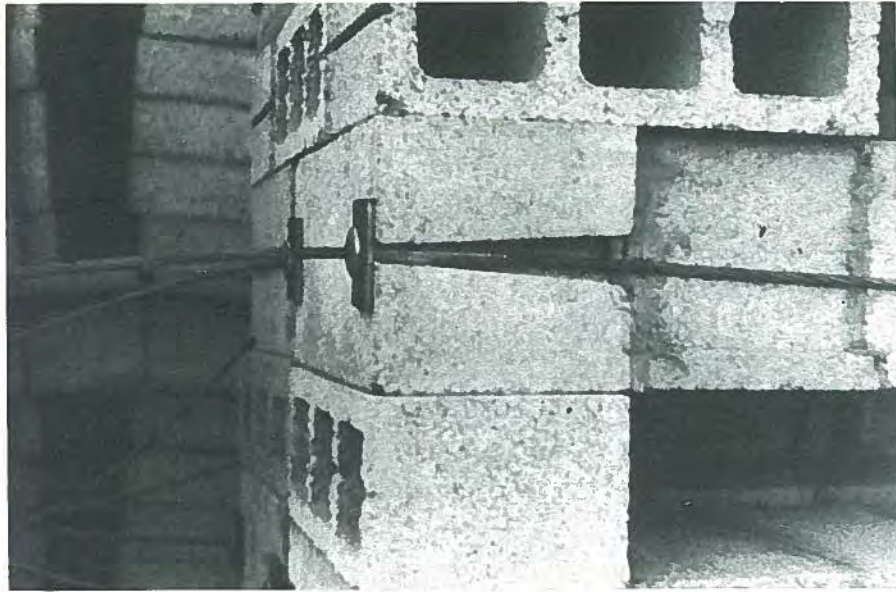

Fig. 8. An 8-in. (203 mm) building beam with bonded strands.

We reduced tensioning costs by making the beams in pairs, end to end, separated by a telescoping jacking frame with fixed anchor frames at each end of the beam line. The strands were

run continuously through both beams and anchored at the end frames. A jack was then set in the telescoping frame and the beams jacked apart and the nuts set up on the frame. The strand



Fig. 9. A 16-in. (406 mm) bridge beam with bonded strands.



Fig. 10. Tensioning two 16x24-in. (406 x 610 mm) block building beams by jacking them apart.

cores were then grouted with 5000-psi (34.5 MPa) grout. When the grout reached release strength the strands were cut and the product removed from the bed (see Figs. 10 and 11).

This method of fabrication for building beams remained unchanged until about 1958 when block beams were replaced by precast pretensioned members. During this period several major structures were built. Among them were the 40,000 sq ft (3720 m²) warehouse for General Shoe Corporation and the 100,000 sq ft (9290 m²) manufacturing plant for the Crosley Corporation, in which the floors were designed for a floor load of 250 psf (0.02 MPa). The largest structure built of prestressed concrete block beams was the roof of the 800,000 sq ft (74,300 m²) warehouse for the Wilkins Air Force Depot at Shelby, Ohio (see Figs. 12, 13, 14, and 15).

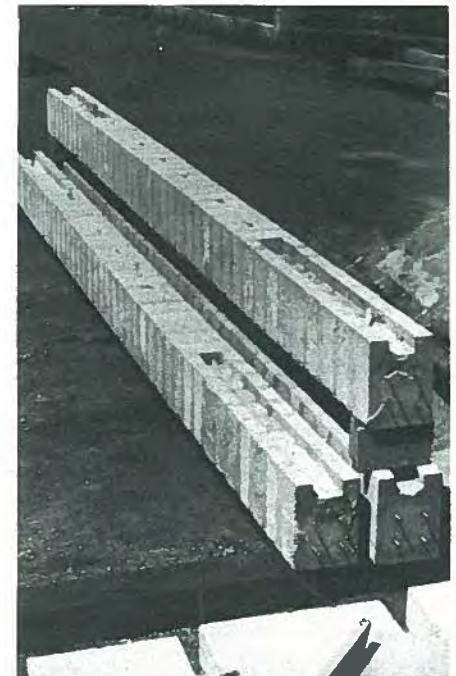

Fig. 11. 12 x 16-in. (305 x 406 mm) building beams with grouted strands. Note slot for continuity steel in 12 x 16-in. (305 x 406 mm) block.

Pretensioned Members

An economical roof system in use during the early fifties consisted of a 2-ft



Fig. 12. Grouting continuity steel in 12 x 16-in. (305 x 406 mm) block beams of 40,000 sq ft (3720 m²) warehouse for General Shoe Corporation.



Fig. 13. Prestressed block joist and filler construction on 100,000 sq ft (9290 m²) warehouse for Crosley Corporation. Joists are made continuous over 18 x 24-in. (457 x 610 mm) prestressed block beams by reinforcing steel in the topping slab.



Fig. 14. Prestressed block joist on 800,000 sq ft (74,300 m²) warehouse for Wilkins Air Force Depot.

(0.6 m) wide precast concrete channel plank with 4-in. (102 mm) legs that would span up to 12 ft (3.7 m). It occurred to us that this member could be made more economical if it were made wider and the span increased by prestressing. This was the beginning of

pretensioned slab construction in Tennessee.

The design of the new channel slab was based on using deflected strands because all of our prestressed block designs were based on this concept. In March of 1953 we constructed, at the



Fig. 15. Fabrication of joist for Wilkins Air Force Depot.



Fig. 16. Fabricating beds at a Breeko plant for producing prestensioned channel slabs with deflected strands. Built in March 1953.

Breeko plant, a prestensioning bed that was notable for two reasons. It was designed for deflecting strands, and it did not require anchorage abutments. The thrust of the strands was carried by the continuous block beams that supported the form (see Fig. 16).

The first production bed was 200 ft (61 m) long and could produce 3-ft (0.9 m) wide channel slabs, up to 14 in. (356 mm) deep, which would span 50 ft (15.3

m) for roof loading. As we all know, the channel slab soon gave way to the double-tee except for heavy floor loading.

In March of 1957 a portable steel bed for site casting was designed for Craftsman Construction Company of Denver, Colorado, to produce 8-ft (2.4 m) wide double-tees with deflected strands. The bed was self-stressing, i.e., it did not require anchorage abutments. The bed

Fig. 17. Continuity test at Breeko Plant. On the left is Lloyd Markham, at center Charley Scott. Man on right probably carried loading blocks. Taken in August 1952.



Fig. 18. Cheatham County Bridge of three 50-ft (15.3 m) spans made continuous by reinforcing in composite pour over supports. Pier caps are precast. Built in 1955.

was used to manufacture products for two large schools.

We began to establish continuity in prestressed products in 1952, by placing reinforcing steel in deep notches formed in the end blocks of block beams near supports. The first test beam was made in the summer of 1952 with three 20-ft (6.1 m) block beams, 8 x 9 in. (203 x 229 mm), prestressed with two $\frac{5}{16}$ -in. (8 mm) strands and made continuous over the two interior supports by placing two $\frac{5}{8}$ -in. (16 mm) reinforcing bars in a poured concrete keyway (see Fig. 17).

The interior supports were purposely offset so the cold joint between the beams was unsupported. We considered the test successful and proceeded to use continuity in all multispan structures using prestressed blocks, including bridge structures (see Fig. 18).

A more sophisticated continuity test was run by the Concrete Masonry Corporation of Elyria, Ohio, for the U.S. Corps of Engineers prior to fabricating

the 33-ft (10.1 m) long, 8 x 18-in. (203 x 457 mm) prestressed block joist to be used on the 800,000 sq ft (74,300 m²) warehouse at the Wilkins Air Force Depot. The test joists were continuous over three spans and were supported by concrete rigid frames (see Fig. 19).

A still more sophisticated continuity test was conducted by the PCA Laboratory at Skokie, Illinois, some 10 years later on prestressed bridge girders made continuous over supports by placing reinforcing steel in the composite slab.

In May of 1954 we designed a prestensioning bed for the T. L. Herbert and Sons Company in Nashville to take a prestressing force of 800 kips (3560 kN) and a strand deflection force of 30 kips (133 kN). The bed was elevated above ground, with slots for deflector rods at 5-ft (1.5 m) centers (see Fig. 20).

The first highway girders with deflected strands were produced on this bed in 1954 for the Ezell Pike Bridge in Davidson County, Tennessee. The

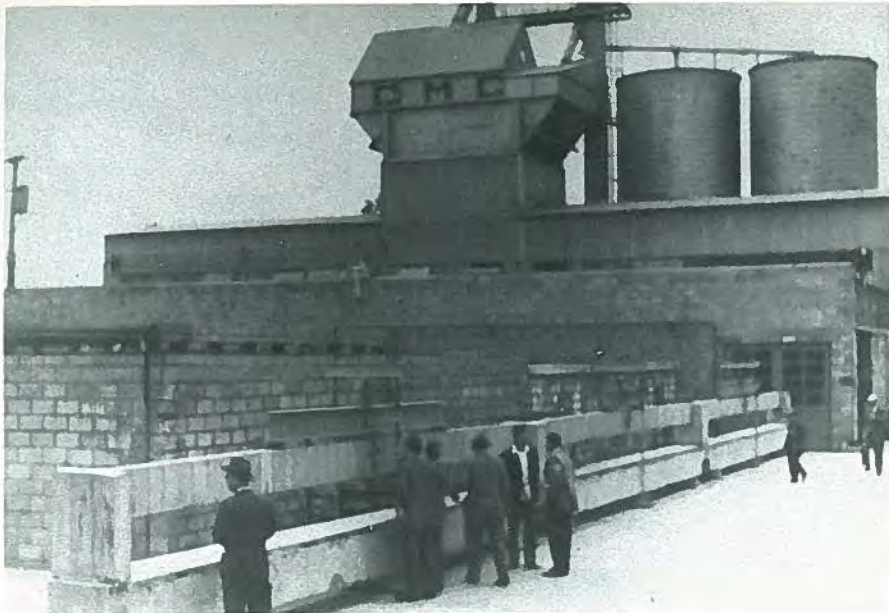

Fig. 19. Continuity test for Wilkins Depot joist.

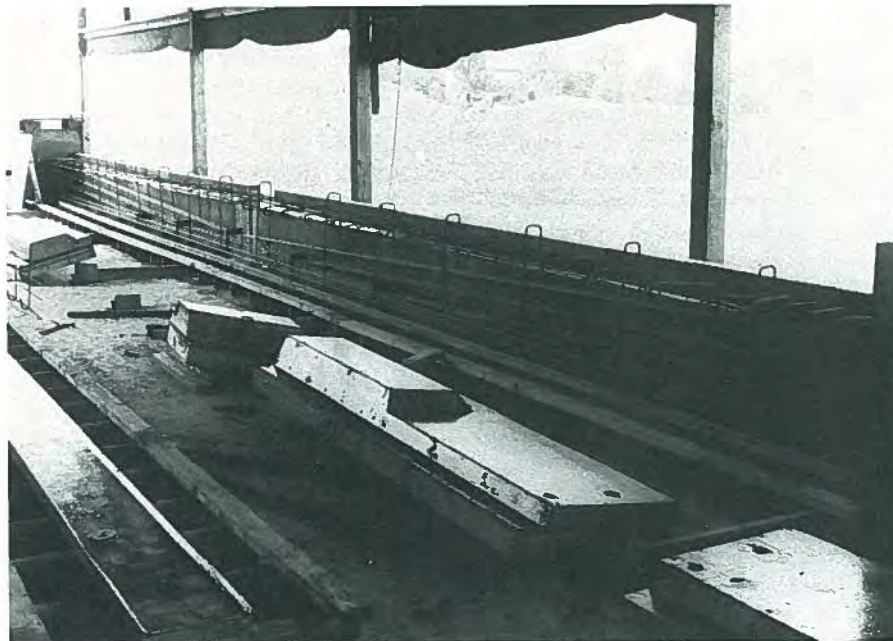

Fig. 20. T. L. Herbert bed for producing pretensioned girders with deflected strands. Built in May 1954.

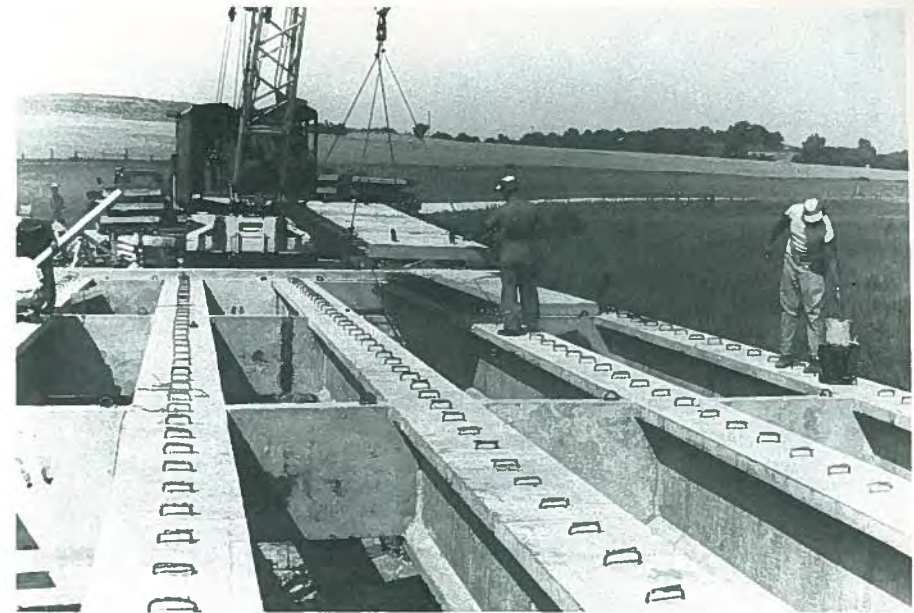

Fig. 21. Ezell Pike Bridge, 80-ft (24.4 m) girders with deflected strands and precast deck slabs. Built in 1954.

bridge has a span of 82 ft (25 m) and was designed for an H-20-44 loading (see Fig. 21).

The longest girders produced on this bed were the 102-ft (31.1 m) girders for

the Milan Gymnasium, Milan, Tennessee (see Fig. 22). The bed was in service for about 4 years when it was replaced by a bed on grade with deflector rails.



Fig. 22. Milan Gymnasium girders, 102 ft (31.1 m) long, with deflected strands. Built in 1955.

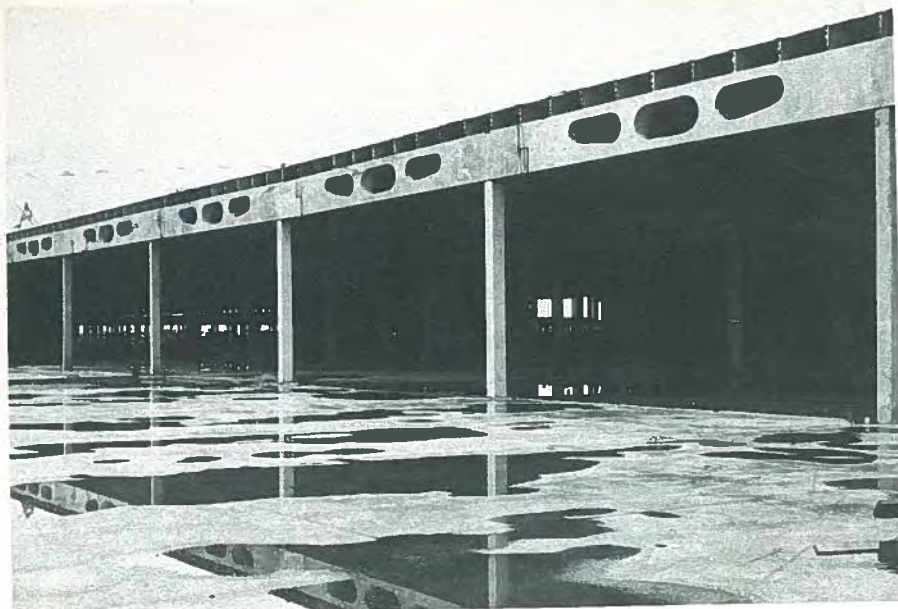

Fig. 23. Open web joist on 40-ft (12.2 m) spans, made continuous by post-tensioning. Built 1964 for Celanese Corporation. Designed by Ross H. Bryan; fabricated by Concrete Materials, Charlotte, NC (Pete Verna).

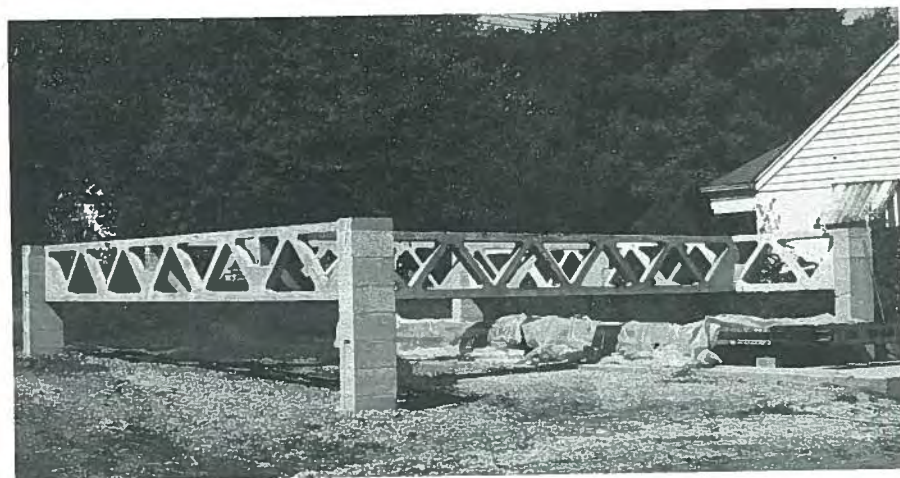

Fig. 24. Prototype prestressed concrete trusses.

* * *

Closing Thoughts

We continued to improve on the design of the pretensioning beds in the ensuing years. Heavy steel jacking beams were replaced by armored concrete buttresses. The end anchorages were designed to resist overturning, using the moment resistance of the deflector beams combined with a variable soil resistance curve. Deflector rails continued to be a problem and still are today.

One major reason for the success of the prestressed concrete industry is that during those early years we anticipated each fresh challenge. The answer came in the form of new products, more efficient cross sections, more economical production techniques, and more imaginative design and construction methods.

No industry can survive without looking towards the future. We must be constantly on the alert and looking towards ways to do things better in the face of new demands and future markets.

Described below is one concept that might merit consideration. If this idea is more fully developed it would add considerable flexibility to prestressed concrete construction. My suggestion is to produce an open web truss/joist system (see Fig. 23). Recently, we designed and tested such a truss (see Figs. 24, 25)⁶ and established a design procedure. Unfortunately, we have not, as yet, been able to come up with an economical fabrication procedure.

If such a joist/truss system could be made on a production line basis and an insulating structural slab made to span about 12 ft (3.7 m), or even 8 ft (2.4 m), prestressed concrete could capture a vast market that is presently closed to the industry.



Fig. 25. Prototype truss undergoing testing in laboratory.

References

1. Bryan, Ross H., "Bridge Built of Block," *Engineering News Record*, January 18, 1951, p. 39.
2. Bryan, Ross H., "Improved Block Beams," *Engineering News Record*, March 20, 1952, p. 52.
3. Bryan, Ross H., "New Designs Cut Prestressed Block Beam Costs," *Engineering News Record*, April 22, 1954, p. 32.
4. Bryan, Ross H., "Pretensioning with Deflected Strands," *Engineering News Record*, June 14, 1956, p. 45.
5. Bryan, Ross H., "On Site Prestressing," *Construction Methods*, October 1957, p. 90.
6. Carroll, William T., Beaufait, Fred W., and Bryan, Ross H., "Prestressed Concrete Trusses," *ACI Journal*, V. 75, No. 8, August 1978, pp. 367-373.

* * *



Part 5—
Prestressed Concrete
Developments in the
Western United States

by
Tadius J. Gutt

Part 5

Prestressed Concrete Developments in the Western United States



Tadius J. Gutt
Assistant Vice President of
Research and Development
TPAC Division of
The Tanner Companies
Phoenix, Arizona

*To climb without peril is
to conquer without glory.*
Corneille,
"Le Cid"

In the late forties and early fifties linear prestressed concrete construction was struggling to gain a foothold in the United States despite the fact that prestressing of circular structures had been practiced in this country for many years.*

In 1947, I joined the Preload Corporation of New York, a progressive company which had pioneered the development of a unique technique for circular prestressing (using a special wirewinding machine). Based on its successful domestic practice, the company was interested in exporting this American

technology to England and continental Europe.

In 1949 I was sent to England by Preload to serve as a consultant to one of their licensees involved in constructing circular prestressed tanks. My task was to explain the principles of American circular prestressing techniques, to train men and to develop the manufacture of local equipment required for construction.

Earlier in this series of papers we learned that Professor Magnel had found it was difficult to get American contractors to understand and use "zero slump" concrete. Conversely, it was equally hard to teach Europeans high productivity techniques

*The first patent for circular prestressing was issued in the United States in 1898.

Based on his personal experiences, the author reflects upon the beginnings of prestressed concrete in Missouri, California, Oklahoma and Texas. He recounts the contributions of Karl Middendorf in developing headed wire and describes the design and construction of the Arroyo Seco Pedestrian Overpass, the first prestressed bridge built west of the Mississippi River, together with some early prestressed concrete structures in the middle and southwest United States.

and sophisticated mechanization concepts.

Actually, not all prestressing technology was flowing from Europe to the United States in 1949-50; for its part, America contributed its share of innovative ideas, prestressing hardware, together with new production and erection techniques.

* * *

American engineers became intrigued with the possibilities of linear prestressed concrete as a result of the:

- Influence of Professor Gustave Magnel of Belgium.
- Construction of the Walnut Lane Bridge.
- English translation of Magnel's book on prestressed concrete.
- Publication of technical articles in *Engineering News Record*, *Civil Engineering*, the *ACI Journal* and other periodicals.
- The use of prestressing for circular structures.

Most American engineers and construction men were spectators and adopted a wait-and-see attitude. How-

ever, there were some who quickly responded to the challenge and potential presented by prestressed concrete.

Karl Middendorf, a practicing engineer, belonged in the latter group. Gifted with an insatiable curiosity and a desire to improve on the accomplishments of others, he always sought ways to stimulate and promote the growth of concrete construction. He was a soft-spoken man who, as Vice President of Preload Central of Kansas City, Missouri, had spent several years designing and building prestressed concrete tanks in the Middle West. Many years previously, he was associated with the Federal Public Works Administration where he was responsible for the construction of all types of bridges and buildings.*

Karl firmly believed that things do not just happen — and his background reflects this drive. He was not only an accomplished 6-ft 4-in. (1.93 m) football player known as "Moose" at the University of Michigan, but also a graduate mechanical engineer who shifted to structural engineering and construction the day he doffed his cap and gown.

*Karl Middendorf was appointed Engineer in the Public Works Administration through the recommendation of then Senator Harry S. Truman.

The Author

Tadius (Ted) J. Gutt has been associated with the prestressed concrete industry for more than 30 years. After receiving his BS Degree in Chemical Engineering from the University of Rochester in 1947, he joined the Preload Corporation in New York City as a field superintendent and designer. He participated in various projects, including the Walnut Lane Bridge.

In 1950, he joined the Prestressed Concrete Corporation of Kansas City. His first assignment was the post-tensioning work for the 110-ft span Arroyo Seco Pedestrian Overpass in Los Angeles, California.

During the Korean war he was assigned to the Special Structures Section of the Civil Engineers Corps where he worked under Arsham Amerikian, Chief Design Engineer at the Bureau of Yards and Docks in Washington, D.C. After his discharge in 1953, he became Vice President of the Texas Stressed Concrete Corporation, where he participated in the design and construction of many of the unusual precast, prestressed structures in that state until 1956.

After 1956 he served first as Vice President of the George Rackle & Sons Company, a precast prestressed firm in his home town of Cleveland, Ohio, and then as Manager of the Cleveland Precast Concrete Division of the Cleveland Builders' Supply Company. In these positions he helped introduce many new concepts and products to the prestressed industry.

Since 1971 he has been Assistant Vice President of Research and Development with the Prestressed Concrete Division of The Tanner Companies in Phoenix, Arizona. Currently, he is chairman of the PCI Plant Certification Committee.

Development of Headed Wire

The two principal post-tensioning anchorage systems developed at that time, namely those of Magnel and Freyssinet, depended *solely* on friction to hold the high tensile strength wires in their anchorages (Fig. 1).

In Middendorf's opinion, this anchorage method was neither efficient nor economical. Friction type anchorages required hardware to be fabricated to very close tolerances and needed machine milled surfaces, both expensive operations. He felt there had to be a positive *non-friction* anchorage.

On March 2, 1950, Middendorf made the following entry in his Idea Diary:

"I have this day, conceived the idea of placing a head on cold drawn wire, thus creating within the wire itself, an anchorage up to now only available by external application of other means."

This headed wire concept was the basis of the system used by today's Prescon Corporation.* Metallurgists had claimed that because of the tremendous force required to form a head on cold-drawn, high-tensile wire, the heads would split and the physical characteristics of the wire would be altered to such a degree that under load, the head would shear off before the wires reached their ultimate strength.

Undaunted, Karl presented his idea of a headed wire to William Ensinger, then President of the Union Wire Rope Company Headquartered in Kansas City, Missouri.† With Ensinger's encouragement, Karl used a nail-making machine

*BBRV, a Swiss firm founded by four engineers—Birkenmaier, Brandestini, Ros and Vogt, developed a similar button head anchorage in 1949. Inryco is currently licensed by BBRV; other United States firms that have been licensed to use the BBRV system include Prescon Corporation, Prestressing Industries, Western Concrete Structures, and American Stress Wire.

†The predecessor of the Amco Corp., and one of the leaders in the development of special high strength wire and strand for the prestressing industry. (Note that Amco Corp. is the oldest continuous Associate Member of PCI.)

to head some 0.162-in. (4 mm) diameter high carbon wire* on March 16, 1950.

The entry in his Idea Diary for that date reads:

"Filed down some heads made in spike machine and tested. Wire broke and heads held. The idea will work!"

What a great accomplishment those last four words represented.

After several heads had been individually formed and successfully tested, Ensinger induced some of his friends to invest in a joint venture to produce and market the product. Thereupon, the Prestressed Concrete, now Prescon, Corporation of Kansas City came into being.

It was at this time that Karl brought in a partner, John C. W. Carroll, a former associate at the Preload Corporation. John was a flamboyant salesman who knew the difference between selling and marketing, one of the first in this industry. Middendorf's vision, coupled with Carroll's salesmanship and Ensinger's financial backing provided the impetus for the growth of the prestressed concrete industry in the Middle West.

After my return from Europe, I was contacted by Karl Middendorf and John Carroll and invited to join the Prestressed Concrete Corporation in their new venture with the headed wire system. Whether to remain in an apparently

*This was the common size wire then in use with the Preload Merry-Go-Round machine that was drawn through a die to provide a prestressing force for prestressed concrete tanks and pipe.



Karl Middendorf

secure position in the growing Preload Corporation, already involved in the young and exciting field of linear prestressed concrete, or to join a new and unknown company pioneering in the field with an unproven concept, was a very difficult decision to make. After much deliberation I felt the challenge could not be passed by, so in the summer of 1950, I pulled up stakes in New York City and, with great enthusiasm, headed for Kansas City, Missouri.

Expectations of a grandiose headquarters for this new company were quickly dispelled upon my arrival. The office consisted of a couple of desks, a large table and a lot of vacant space in which to improvise and experiment. Karl, John and I would spend many hours, often late into the night, exploring ways

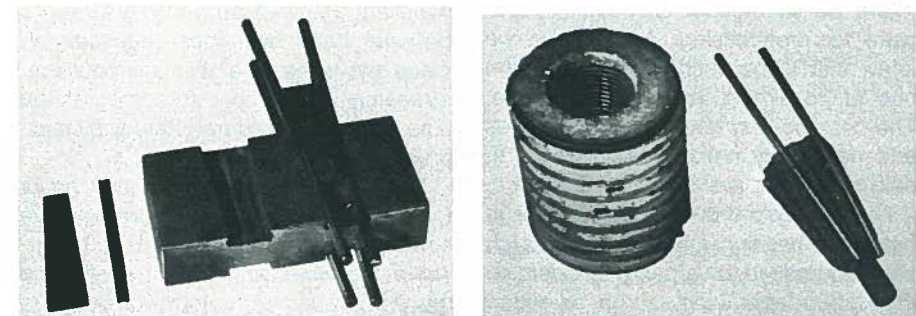

Fig. 1. Magnel "wedge" and Freyssinet "cone" friction anchorages.

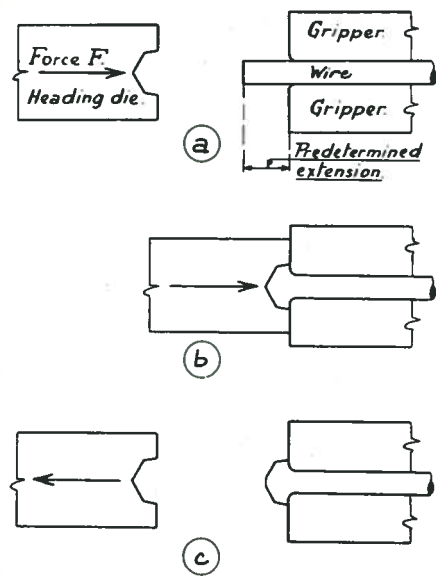

Fig. 2. Sequence of heading wire.

and means of making the headed wire a practical and economical system.

Since we could not easily afford to buy wire or other equipment for experimental purposes, we would estimate how many heads two men could make per hour by going through the process substituting a pencil for the wire. We would walk up and down the large vacant office with a piece of string to determine how to uncoil, measure to an accurate length, cut, head and place the "wire" into a neat and orderly "cable."

While it was true that the ability to "head" a wire was quite an accomplishment, we still needed to develop hardware for prestressing. Additionally, we knew that to be successful the system had to be simple and especially safe. The heading and tensioning procedures and necessary hardware which we finally developed are described below.

To head cold-drawn wire, the wire is held in a heading machine, on the job site if so desired, by a pair of grippers so that a predetermined length extended beyond the grippers (Fig. 2a).

A die is then forced over the extended wire, causing it to flow, thereby upsetting the wire and shaping it into a "head" (Figs. 2b and 2c). The entire operation of placing the wire in the heading machine, heading and removing it, requires less than 20 seconds.

As shown in Fig. 3, the anchorage assembly for the headed wire as originally developed for the stressing (live) end consists of a steel bearing plate, shims, stressing anchors, $\frac{3}{8}$ -in. (15.9 mm) square or round washers and the headed wires.

The stressing procedure is to place the washer at each end of the wire and to "head" the wire as described above. Placed in horizontal layers of five or six wires, the washers bear directly on the steel plates at the non-stressing (dead) end of the girder. At the stressing end, the washer bears against the $3\frac{1}{2}$ -in. (88.9 mm) deep, 1x4-in. (25.4 x 101.6 mm) notched stressing anchors.

Jaws mounted on the 25-ton (22.7 t) hydraulic stressing jack are placed in the notch of the stressing anchors and pull them away from the end face of the girder to achieve the elongation which induces the desired stress in the wires. A check of the stress is obtained by pressure gauges.

U-shaped, cast-iron shims are then inserted in the space between the stressing anchors and the bearing plate, holding the stress in the elongated wire. The entire end section is then encased in concrete for final protection.

Karl Middendorf was not yet entirely satisfied. He was probably the first to believe that it was not necessary to place the wires in a duct or grout prestressing units after stressing. At the time this was considered heresy by most prestressing engineers.

Nonetheless, Karl spent many hours trying to develop a bond preservative coating material that would both preserve the wires and permit positioning the wire groups in the formwork, placing the concrete and then stressing after

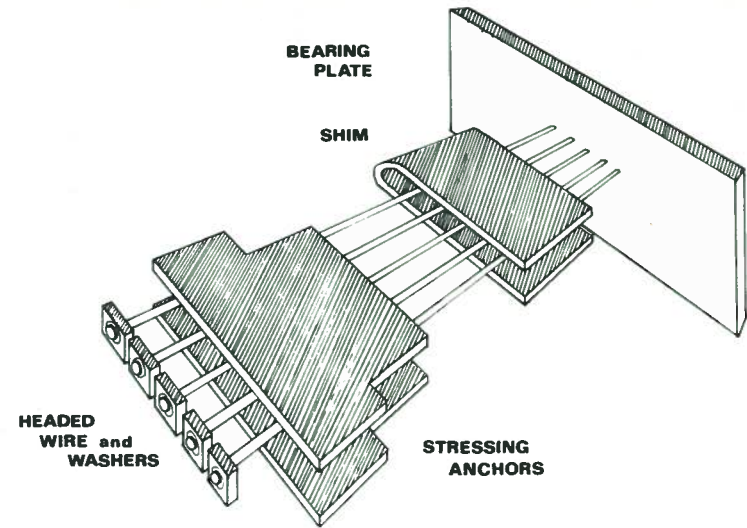

Fig. 3. Five or six-wire anchorage assembly, shown with five wires.

proper concrete strength was obtained. In his calm and easygoing way, he tried to move away from the beaten path.

The West's First Prestressed Bridge

While we were developing techniques on a shoestring budget in Kansas City, bridge designers in the California Division of Highways were following the progress of prestressed concrete with great interest and were looking for an opportunity to apply this new construction method to one of their own bridges. However, even though the principles of prestressed concrete design were known and could easily be applied, there was very little practical experience and a lack of specifications and data for job site quality control.

The California designers wanted to build a modest prestressed bridge on an experimental basis and test the feasibility of this construction technique for themselves. Then based on this experience, they could go forth and build more ambitious bridges with confidence.

An opportunity to do just that occurred in 1950. A state-owned bridge over the Arroyo Seco flood control channel near South Pasadena, California, had already been designed using conventional reinforced concrete. However, its construction had been deferred due to shortages of materials.

This project appeared to be ideally suited for the first prestressed effort in California for a number of reasons.

- It was a small project, but a 110-ft (33.6 m) long single span was required.
- Because it was a pedestrian bridge, it would carry a modest live load and not be subject to future overloading.
- The bridge was to be located in an urban area with easy access for construction and future observation.
- Instrumentation would be relatively simple and economical.
- Test loads could be applied without interrupting traffic as would have been the case for structures on any major highway artery.

Since a standard reinforced concrete bridge had already been designed and estimated costs developed, this was an opportunity to determine if claims for the economy of prestressed concrete design and construction were factual. Based on the above considerations, the California Highway Department decided to proceed with a prestressed concrete design.

During the preparation of plans and specifications for the Arroyo Seco Bridge, the Department requested and received much data and helpful information from the Pacific Bridge Company of San Francisco, who held the rights to the Magnel-Blaton system on the West Coast, and from Raymond Concrete Pile Company, who held the rights to the Freyssinet system in the United States.

The State of California made extensive preliminary studies in order to prepare adequate plans and Special Provisions detailed enough to maintain adequate quality control over materials and construction procedures without dictating any specific prestressing construction system.

When the bids were received in September of 1950 on the State's open design, the low prestress bidder was none other than the newcomers from Kansas City, whose biggest assets at that time were imagination and guts. We had only a partially tested anchorage system, a sometimes working heading machine, no finances to speak of, a small organization, and a lot of hand tools and string.

In addition, the job was 2000 miles (3200 km) from home-base and thus hard to organize, direct and supervise. We were not sure how we were going to proceed, but we were determined somehow to get the job done and done well.

I was chosen to supervise the preparation and installation of the post-tensioning units for the girders, to be cast by the general contractor, Walter Kaucher, on the Park roadway near the site. Upon my arrival in Los Angeles in

the latter part of November, 1950, I rented a room in a small boarding house and opened a checking account at a local bank. That constituted the Western office of the Prestressed Concrete Corporation (PCC) of Kansas City, Missouri.

Design Criteria

The Arroyo Seco Bridge* was constructed over a paved flood channel which bisected the Arroyo Seco Park near Avenue 58 and the Pasadena Freeway. Since the park was not closed to the public during construction, extreme measures were taken to keep the area around the girder fabrication site clean and orderly.

The Arroyo Seco Bridge consists of two 111.5-ft (34.0 m) T-shaped girders, spaced at 9 ft 8 in. (2.0 m) on center, with a 5-in. (127 mm) cast-in-place slab near the bottom of each girder to form the walkway (Fig. 4). The top and bottom of the girders are parallel parabolic curves, with the top flange of each girder serving as a handrailing. The outside faces of the vertical webs were cast against a fluted plywood form.

The combination of the resulting decorative surface and the parabolic curve presents a graceful and aesthetically pleasing appearance in this park setting. Since two of the first three major prestressed bridges in the United States were built in public parks, their prestressed concrete designs had to be aesthetically, as well as structurally, sound.

The State plans allowed any acceptable method of post-tensioning available at the time. The size and number of the prestressing wires required and the method of anchorage were not shown on the bid drawings. The specified criteria were as follows:

Concrete: 5000 psi (34.5 MPa) at 28 days with a working stress of 1700 psi (11.7 MPa) at design loads.

*Arroyo Seco means "Dry Channel."

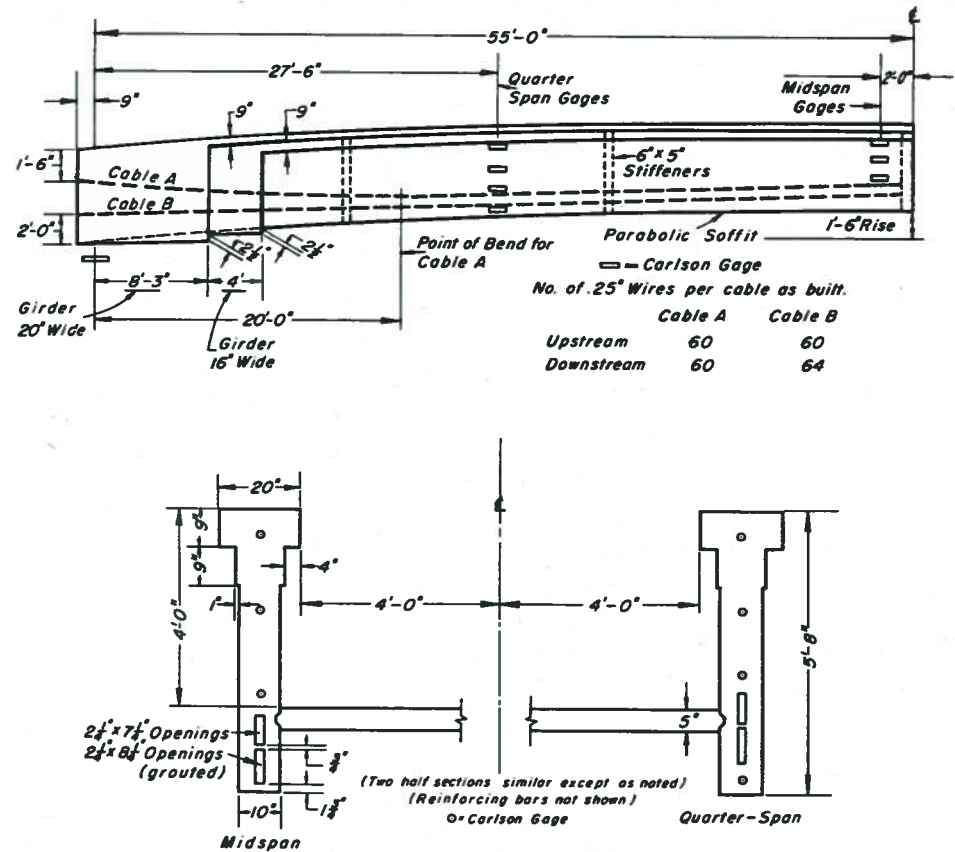

Fig. 4. Cross section of Arroyo Seco Pedestrian Overpass.

Wires: Minimum ultimate of 200 ksi (1380 MPa) and a working stress of 0.6 of ultimate and to comply with ASTM/229-41. Minimum diameter of 0.10 in. (2.5 mm), maximum of 0.30 in. (7.6 mm).

Total Initial Prestressing Force: 715 kips (3180 MN) per girder, allowing for 15 percent losses.

To meet the State's open design criteria, we devised a pattern of 125 1/4-in. (6.4 mm) diameter, cold-drawn, high-tensile wires per girder. These were to be placed in two units, one of 65 wires and one of 60 wires. In each unit the wires were arranged in horizontal rows of 5 wires with a specially designed stressing anchor for each group of five.

A total initial force of approximately 35 kips (156 MN) was to be applied to each group.

Application of Headed Wire

The wire arrived at the site in 4.5-ft (1.4 m) diameter coils from Union Wire Rope Company of Kansas City. Our first task was to develop a method of uncoiling the wire and measuring it to exact lengths. Unlike friction systems of prestressing, the headed wire method required wire in exact predetermined lengths including an allowance for "head" formation.

Since the wire had not been straightened at the mill, our first attempts at uncoiling resulted in huge spring-like



Fig. 5. Wooden trough for measuring and cutting wire.



Fig. 6. Headed wire and heading machine.

coils of entangled 113-ft (34.5 m) wires. This particular problem was solved by forming a wooden "trough" with swing wedges to hold the wire. Once in the trough, the wire was cut, then removed and placed into piles with weights along the piles to keep the wire from tangling (Fig. 5).

Each wire was then threaded through the bearing plates and stressing anchors, a special washer threaded over each end and each end of the wire "headed" (Fig. 6). Note that at the time, in the Los Angeles area there were no suppliers of prestressing hardware for the headed wire system and end bearing

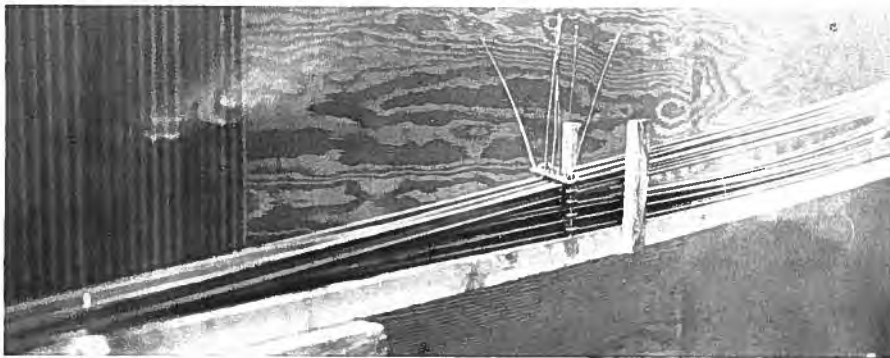

Fig. 7. Hand-formed wire spacer in position.

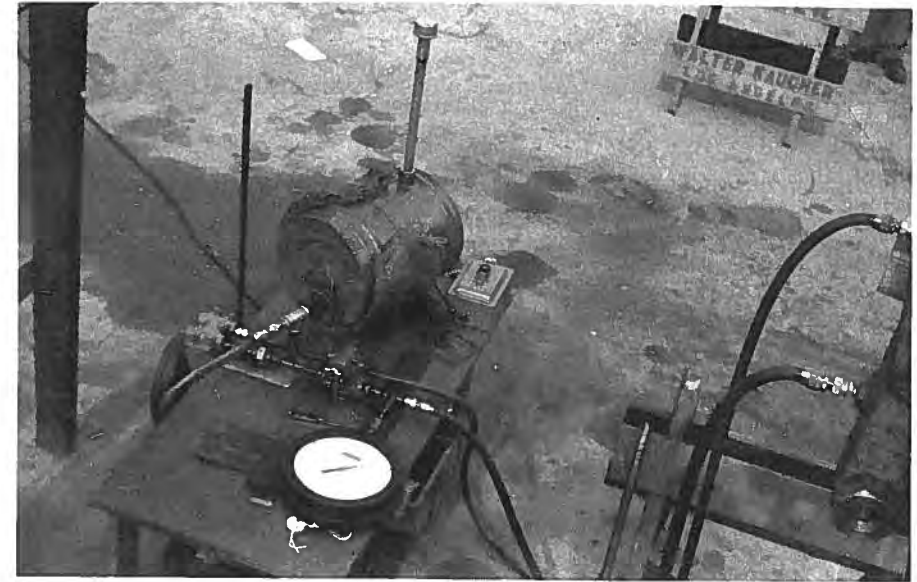

Fig. 8. Assembled stressing equipment.

plates; 5-wire stressing anchors and shims had to be designed and then manufactured locally to our own specifications.

Construction

The general contractor chose to use one set of forms to cast both girders. A system using two-piece sheet metal ducts was designed and fabricated to contain each group of wires in the girders during concrete operations. In order to keep each horizontal row of 5 wires separated during stressing and to minimize friction between wires, a soft wire spacer was devised and fabricated by hand (Fig. 7).

Since there was no available job site equipment large enough to handle completed 60 and 65-wire units, they were fabricated directly in the forms. When all the components were in place, the remaining fascia form was then set and braced and the first girder was cast January 3, 1951.

After a long search, we found a local firm that would assemble a stressing ram and rigging that could provide the

necessary 20 tons (18.1 t) of stressing capability. High pressure cylinders and pumps were a rarity, and I was compelled to use a very large cylinder [43 in.² (27,700 mm²)] with a maximum 1000-psi (6.895 MPa) pump. The State specifications required that each group of wires be stressed to 35 kips (156 kN) and held there for 2 minutes for stress-relieving of the wire.*

Two minutes does not sound like a long time, but it was long enough for the oil in the pump and reservoir to become hot and foam out of the air vent. With the addition of more tanks and constant watering of a burlap sack thrown over the reservoir, the oil "eruptions" that occurred during stressing of each 5-wire unit were finally stopped (Fig. 8).

About a week after casting this first girder, but before it reached design strength, groups of the 5-wire layers were stressed to an elongation of about 1 in. (25.4 mm) to compensate for shrinkage and prevent shrinkage cracks in the girder. During this preliminary

*It should be remembered that in 1951 no wire stress-relieved at the mill was produced.

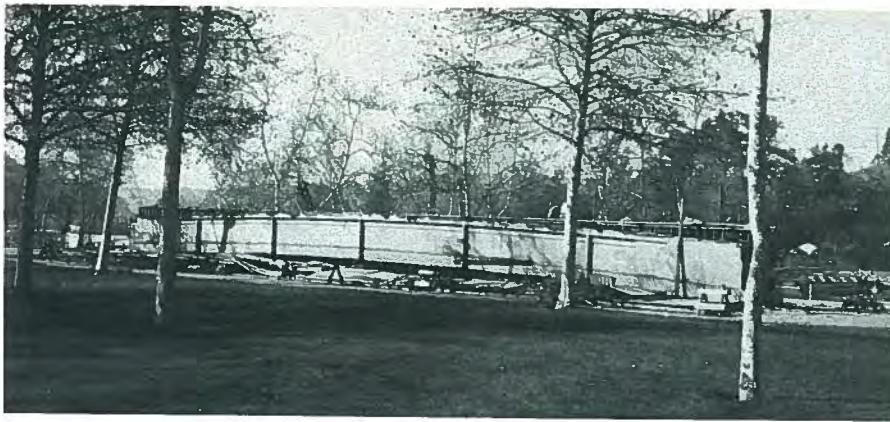

Fig. 9. Completed girders at casting site in Arroyo Seco Park.

stressing, the jaws on the stressing equipment failed because of unintentional eccentric loading. Thus, back to the drawing board we went to develop stronger jaws that would still fit into the limited space available at each 5-wire anchorage.* The second girder was cast January 19, 1951 (Fig. 9).

During the final stressing of the first girder after the concrete reached its full design strength, one of the 5-wire anchorage units failed and we lost all 5 wires. The required total force was made up by slightly overstressing the remaining 120 wires.

In the other girder, one wire broke for no apparent reason and "shot out" the opposite end for about 60 ft (18.3 m). Its share of the total force was distributed over the remaining wires (Fig. 10).

Both girders were fully stressed by February 19th, less than 3 months after the beginning of construction. This was considered quite an accomplishment. Most of those concerned—the State, contractor, testing agency and last but not least myself—were not familiar with either the realities of prestressed concrete construction or the job site performance of headed wire prestressing equipment and materials.

*This is one reason the Kansas City "braintrust" modified the hardware as described later in this article.

The obvious interest of the many visitors confirmed the wisdom of the California State Highway Department in choosing a convenient metropolitan site. However, we finally had to post an "Observe at Your Own Risk" sign on the girders because of the difficulty of keeping visitors at a safe distance during stressing operations.

One final task remained for the Prestressed Concrete Corporation before the 50-ton (45.4 t) girders could be installed, namely to pressure-grout the ducts containing the prestressing wires. Since there was no small volume, high pressure grouting equipment available in the area, we finally decided to hire the Halliburton Oil Field Drilling & Grouting firm for the job.

Halliburton arrived at the job site with two huge trucks and after a few questions, hooked up their equipment, grouted the girders and completed the job in a couple of hours (Fig. 11). We had all been concerned about this delicate and vital portion of the project, but it turned out to be the easiest part of the entire job. It was not the most economical operation, perhaps, but surely the fastest and best executed.

The spectacular operation of moving the long, slender girders from the casting site to the abutments was accom-



Fig. 10. Stressing the Arroyo Seco girders.

plished by using three cranes. To minimize whipping and vibration of the limber girders during installation, they were trussed to provide additional stiffness. Cables ran the full length of each side over blocking protruding from the top flange at midspan.

A 45-ton (40.8 t) crane, then said to be the largest in the West, was positioned at one end of the girder, while two 35-ton (31.8 t) cranes were positioned at the other end. Each girder was swung into the middle of the channel and placed on cribbing, then lifted



Fig. 11. Halliburton grouting the girders.



Fig. 12. The three cranes begin to lift the girders into place.

into position on the abutments. So spectacular and unusual was this installation that it was covered live by the local television station (Figs. 12 and 13).

Since this was an experimental bridge for the State of California, seven Carlson strain gauges were installed in each girder—three near midspan and four at the quarter point. The entire bridge was to be load tested in place after the walk-

way slab had been completed. The California Division of Highways had engaged the services of the Institute of Transportation and Traffic Engineering of the University of California to provide instrumentation of the girders and supervise the testing program.

The Institute was represented at the job site by an Associate Professor of Civil Engineering by the name of T. Y.

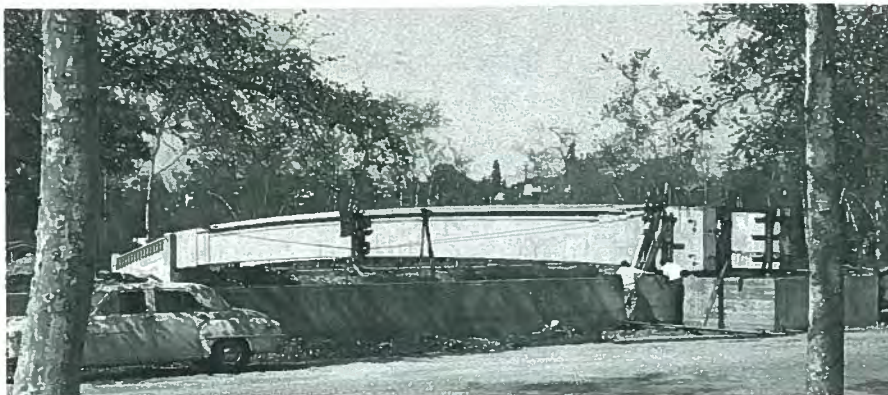

Fig. 13. Girder in place, with trussing for extra stiffness during transportation.

Lin, who had recently returned from a visit to his native China. He was an enthusiastic and energetic man eager to learn all about prestressed concrete and at the project almost daily, asking pointed questions that were sometimes difficult for us to answer.

The Arroyo Seco project aroused Professor Lin's curiosity so much that he later applied for and obtained a Fulbright Fellowship and went to Belgium for a year to study under Professor Gustave Magnel. Shortly after his return from Europe, he published the first American textbook on design and analysis of prestressed concrete. Today, Professor Lin is known as both a pioneer and world leader in prestressed concrete design analysis and construction.

The cast-in-place walkway deck was completed and tested in early May. The girder, tested with double the design load, passed with flying colors.

The Arroyo Seco Pedestrian Overpass was placed in service in June, beginning a new era of bridge construction in California. It was the first structure built with an American linear prestressing system, and because of it, the prestressed concrete careers of several persons were launched.

Developments in Oklahoma

It became apparent after the Arroyo Seco project was completed that, from the viewpoint of field operations, the original anchorage hardware developed was deficient on two counts:

1. The need for two notched, cast-iron stressing anchors made stressing an awkward and cumbersome operation, and
2. The 3.5-in. (88.9 mm) anchorage length reduced the effective span (length) of the girder. As the girder support had to be moved inward

from the encased end face, the support required widening.

It did not take long to eliminate these undesirable features. While I was in California, immersed in the maze of Arroyo Seco construction problems, Karl Middendorf and John Carroll in Kansas City had been able to interest the Blairs of Tulsa, Oklahoma, in prestressed concrete work.

P. F. Blair was a no-nonsense contractor who had spent a lifetime in the contracting field. His son, Percy Jr., a college educated construction engineer, worked with him. This excellent combination of practical experience on the one hand and theoretical knowledge on the other helped us simplify the construction procedure of the headed wire.

To solve the problems of awkwardness and bulk, we replaced the 3.5-in. (88.9 mm) stressing anchor with a 0.75-in. (19.1 mm) thick threaded washer capable of holding one to seven 0.25-in. (6.4 mm) diameter wires (Fig. 14). The extension arm of a stressing jack could then be threaded on the washer, thereby eliminating the need for stressing anchors.

The use of the threaded washer reduced to a minimum the length of the entire anchorage unit at the live end of the girder. At the dead end, the heads were to bear directly on the steel bearing plate. Except for the headed wire, all the elements of the anchorage were in compression so no costly milling or finishing was required.

The Blair-modified anchorage was first used in constructing eleven 40-ft (12.2 m) long precast girders for the Mid-Western Geophysical Laboratories at Tulsa, Oklahoma. These monolithic I-shaped girders are believed to be the first prestressed concrete "building" elements erected in the United States. Girder depth varied from 26 in. (660 mm) at midspan to 24 in. (610 mm) at the supports. These girders were designed by Charles C. Zollman, then

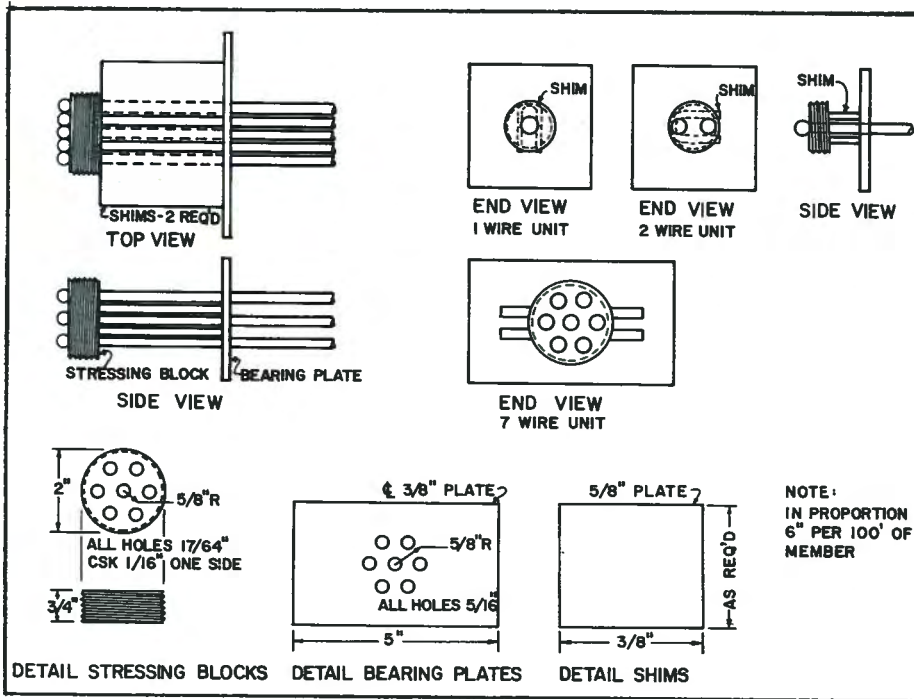

Fig. 14. Redesigned headed wire anchorage assembly.

Chief Engineer of Prestressed Concrete Corporation, Kansas City, Missouri.

Tests on a full-sized building girder preceded the erection. The test arrangement used a Johnson Fagg recording dynamometer in conjunction with a calibrated ring from which direct load readings were taken (Fig. 15). This loading procedure was then current practice in oil field construction and was suggested by Percy Blair, Jr.

Developments in Texas

Is it true that "two heads are better than one"? A holding company in Texas apparently believed this axiom when they founded Prestressing, Inc. (P.I.) in May of 1952. One of its founders was Jim Mennis, then a young engineer who had worked briefly with Karl Middendorf and with the single headed wire in Kansas City.



Fig. 15a. Closeup of recording dynamometer on test girder.

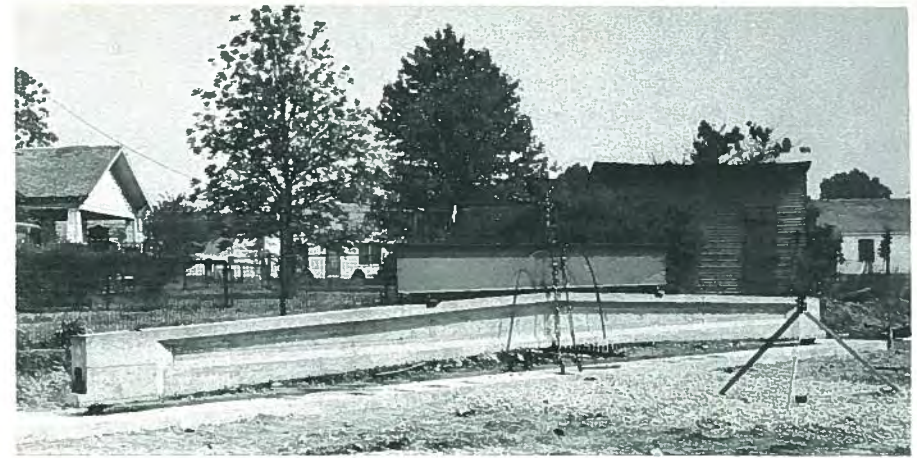

Fig. 15b. Test equipment in position on 40-ft (12.2 m) girder, Tulsa, Oklahoma.

The single headed wire system utilized one head at the end of each wire to stress and anchor it. Mennis proposed to make two heads at each end of each wire; one at the very end (outer head) and another "head" or protrusion on the wire (inner head) about 6 in. (152 mm) from the end (Fig. 16).

With this system the outer head would be used to attach a stressing bar to stress a group of wires with a hydraulic ram. The inner head would bear on an anchorage ring under which flat split shims would be placed after stressing to hold the tensioned group of wires in a permanent, positive way (Fig. 17).

The portion of the wires outside the inner head would be cut off after stressing. The two-headed wire system thus did not require as much of the permanent end anchorage to extend beyond the end of the post-tensioned member. The length of concrete required to cover the anchorage would be substantially less and the support could be closer to the end of the girder.

P.I. licensed various firms to utilize the two-headed wire system for post-tensioned members. One of the early licensees was the Texas Stressed Concrete Corporation of Austin, Texas,



Fig. 16. Double-headed wire.

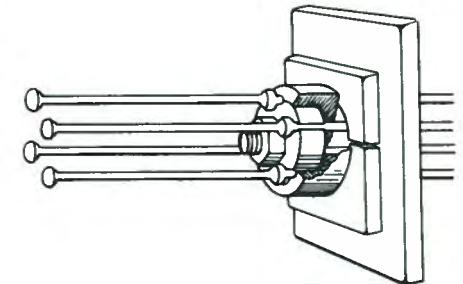

Fig. 17. Double-headed wire with anchorage.

which was organized in the spring of 1953 by four local general contractors and a holding company.* In May of 1953, after serving a tour of duty with the U.S. Navy, I began yet another prestressing venture as Vice President of Texas Stressed Concrete Corporation.

*W. S. Bellows Construction Co., H. B. Zachary & Co., McKinney Drilling Co., Harry Newton, Inc., and Tex Star Corp.

Prestressed Lift Slabs

The first contract received by the new company in Texas was for post-tensioning units and stressing operations for the first prestressed "waffle" type lift slab in the United States.

The post-tensioning units used on this project, a physics building for the Southwest Research Institute in San Antonio, Texas, were among the first to be greased and wrapped in lieu of being placed in some type of duct to prevent bond with the concrete. Again, Karl Middendorf's ideas were coming into use—this time with the unbonded pre-stressing wire unit.

Many trials were necessary, using various types of grease and wrapping materials before success was achieved. The grease was applied by hand to stressing units which were suspended at each end and supported by intermediate horses. Some greases were too stiff and difficult to apply; others were too thin and did not provide a uniform coating or drained off the wires in the hot sun.

Rolls of Sisal-Kraft paper [4 in. (102 mm) wide] were tried as a wrapping, but they proved to be too bulky and stiff and could not be wound around the wire units tightly enough to prevent leakage of cement paste into the wire unit. A clear plastic wrapping, also in 4-in. (102 mm) wide rolls, was used with better results.

The San Antonio physics building consisted of three levels of precast waffle slabs, to be post-tensioned in both directions. The slabs were continuous in the longitudinal direction over three supports with cantilevers at each end, but were single spans with cantilevers at each end in the transverse direction. Since the post-tensioning units were continuous and followed moment curves in both directions, placing wire units in the legs between the waffle slab was like knitting with spaghetti needles.

In the fifties there were, of course, no computers to determine upper and lower

elevations of the wire units or to insure that wire units at 90 degrees from each other would not be in the same horizontal plane. Any calculations made had to be done in longhand and therefore the units were placed mostly by common sense instead of from drawings (Fig. 18).

The San Antonio structure is particularly interesting because it is believed to be the first where wire units continuous over several spans were used. It is even more interesting that not long before this construction Professor Magnel made the statement:

"Don't ask me about continuous prestressed structures . . . I don't know yet how to design for it . . . Let us first learn to walk before we run."

Magnel was referring, of course, to sound and safe construction of simply supported structures before tackling the more sophisticated continuous structures.

Tilt-Up Wall Panels

Another novel use of prestressed concrete was the two-way tensioning of the 21 ft x 24 ft x 5 in. (6.4 m x 7.3 m x 127 mm) tilt-up concrete wall panels at Baylor University in Waco, Texas. The post-tensioning units consisted of two ¼-in. (6.4 mm) diameter wire units, greased and wrapped and placed 48 in. (1.2 m) on center in both directions.

The wire units were used to provide strength during the lifting operations and to prevent cracking of the panels when in their final position. This same project also included 65-ft (19.8 m) long prestressed beams with a 50-ft (15.3 m) clear span and a 15-ft (4.6 m) cantilever at one end.

To reduce the cost of forming the void for post-tensioning units, we tried using a relatively soft rubber hose to replace the flexible metal tubing. A 1-in. (25.4 mm) diameter hose was inflated with air to a 1¼-in. (31.8 mm) diameter, placed in the formwork and tied with string to the stirrup reinforcement.

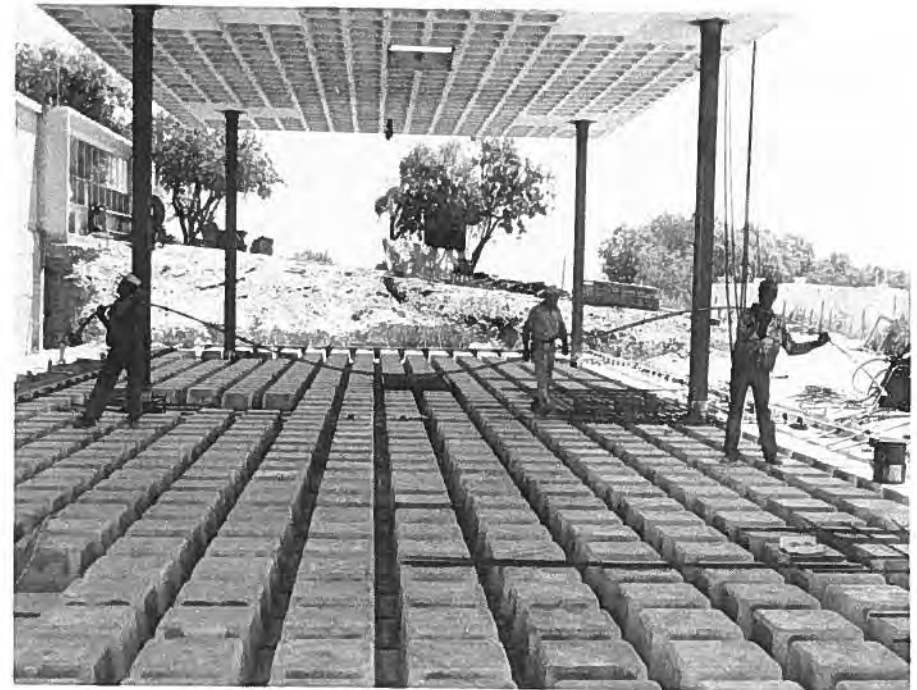

Fig. 18. Prestressing tendons being placed in waffle slab (Southwest Research Institute, San Antonio, Texas).

We used string rather than wire to avoid puncturing the rubber tube and losing air. The string had to be tied rather loosely to avoid having a rubber tube that resembled a string of sausages (Fig. 19). The idea was to release the air after the concrete had set, then remove the collapsed tubing, leaving a nice hole in the concrete through which wire groups could be strung.

The experiment was not a success. Among other difficulties, the air in the hose expanded from the heat of hydration as the concrete set, and we wound up with precisely what we tried to avoid, namely, a series of "sausages" between tie points. As a result, the deflated rubber hose would not come out. When we tied the hose end to a pick-up truck and tried to remove the hose, it stretched like a rubber band and slowly dragged the truck back toward the end of the beam.



Fig. 19. Forms with inflatable rubber voids.

Prestressed Lift Slabs

The first contract received by the new company in Texas was for post-tensioning units and stressing operations for the first prestressed "waffle" type lift slab in the United States.

The post-tensioning units used on this project, a physics building for the Southwest Research Institute in San Antonio, Texas, were among the first to be greased and wrapped in lieu of being placed in some type of duct to prevent bond with the concrete. Again, Karl Middendorf's ideas were coming into use—this time with the unbonded pre-stressing wire unit.

Many trials were necessary, using various types of grease and wrapping materials before success was achieved. The grease was applied by hand to stressing units which were suspended at each end and supported by intermediate horses. Some greases were too stiff and difficult to apply; others were too thin and did not provide a uniform coating or drained off the wires in the hot sun.

Rolls of Sisal-Kraft paper [4 in. (102 mm) wide] were tried as a wrapping, but they proved to be too bulky and stiff and could not be wound around the wire units tightly enough to prevent leakage of cement paste into the wire unit. A clear plastic wrapping, also in 4-in. (102 mm) wide rolls, was used with better results.

The San Antonio physics building consisted of three levels of precast waffle slabs, to be post-tensioned in both directions. The slabs were continuous in the longitudinal direction over three supports with cantilevers at each end, but were single spans with cantilevers at each end in the transverse direction. Since the post-tensioning units were continuous and followed moment curves in both directions, placing wire units in the legs between the waffle slab was like knitting with spaghetti needles.

In the fifties there were, of course, no computers to determine upper and lower

elevations of the wire units or to insure that wire units at 90 degrees from each other would not be in the same horizontal plane. Any calculations made had to be done in longhand and therefore the units were placed mostly by common sense instead of from drawings (Fig. 18).

The San Antonio structure is particularly interesting because it is believed to be the first where wire units continuous over several spans were used. It is even more interesting that not long before this construction Professor Magnel made the statement:

"Don't ask me about continuous prestressed structures . . . I don't know yet how to design for it . . . Let us first learn to walk before we run."

Magnel was referring, of course, to sound and safe construction of simply supported structures before tackling the more sophisticated continuous structures.

Tilt-Up Wall Panels

Another novel use of prestressed concrete was the two-way tensioning of the 21 ft x 24 ft x 5 in. (6.4 m x 7.3 m x 127 mm) tilt-up concrete wall panels at Baylor University in Waco, Texas. The post-tensioning units consisted of two ¼-in. (6.4 mm) diameter wire units, greased and wrapped and placed 48 in. (1.2 m) on center in both directions.

The wire units were used to provide strength during the lifting operations and to prevent cracking of the panels when in their final position. This same project also included 65-ft (19.8 m) long prestressed beams with a 50-ft (15.3 m) clear span and a 15-ft (4.6 m) cantilever at one end.

To reduce the cost of forming the void for post-tensioning units, we tried using a relatively soft rubber hose to replace the flexible metal tubing. A 1-in. (25.4 mm) diameter hose was inflated with air to a 1¼-in. (31.8 mm) diameter, placed in the formwork and tied with string to the stirrup reinforcement.

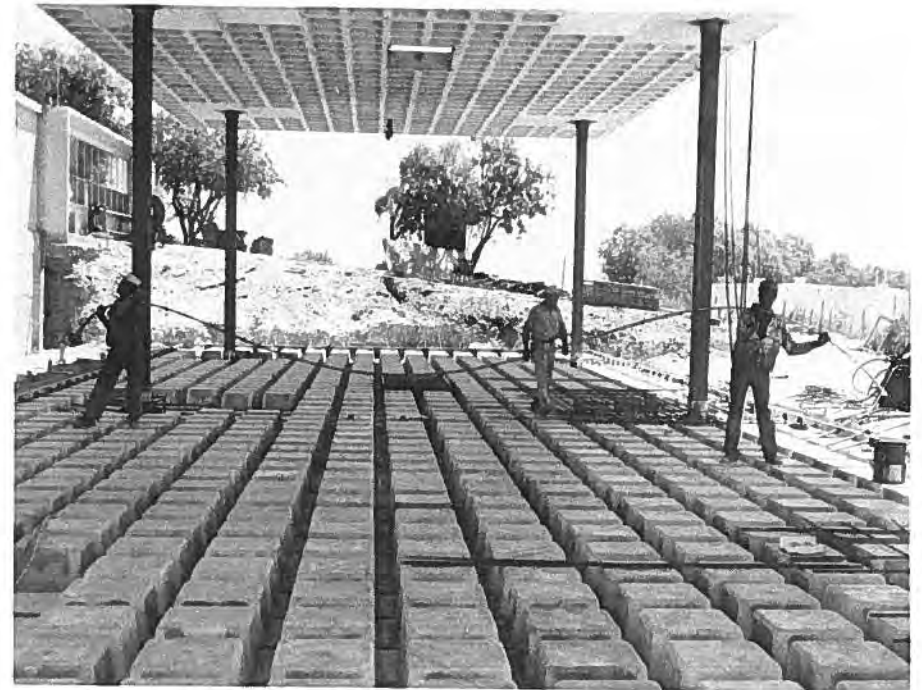

Fig. 18. Prestressing tendons being placed in waffle slab (Southwest Research Institute, San Antonio, Texas).

We used string rather than wire to avoid puncturing the rubber tube and losing air. The string had to be tied rather loosely to avoid having a rubber tube that resembled a string of sausages (Fig. 19). The idea was to release the air after the concrete had set, then remove the collapsed tubing, leaving a nice hole in the concrete through which wire groups could be strung.

The experiment was not a success. Among other difficulties, the air in the hose expanded from the heat of hydration as the concrete set, and we wound up with precisely what we tried to avoid, namely, a series of "sausages" between tie points. As a result, the deflated rubber hose would not come out. When we tied the hose end to a pick-up truck and tried to remove the hose, it stretched like a rubber band and slowly dragged the truck back toward the end of the beam.



Fig. 19. Forms with inflatable rubber voids.

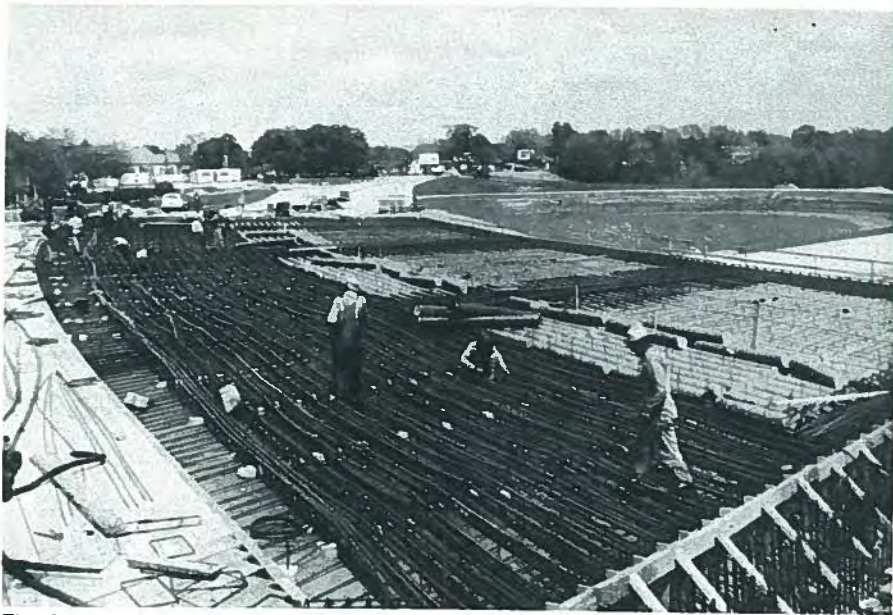

Fig. 20. Waugh Drive Bridge under construction.

Waugh Drive Bridge

Prestressed concrete had by now become an intriguing and exciting field. Everyone designing prestressed concrete structures had fresh ideas on how to take advantage of this exciting and versatile material.

One of these innovators was Francis Niven, a consulting engineer in Houston, Texas. To meet a particularly demanding set of criteria for a bridge at the intersection of two superhighways in Houston, he came up with an imaginative prestressed design which had never been tried before in the United States.

The Waugh Drive Bridge is a 72-ft (22.0 m) wide, 24-in. (610 mm) deep voided slab structure continuous for four spans and super-elevated on a 764-ft (233 m) radius, with pin-supported columns skewed at 45 degrees to the centerline of the bridge. Not much else could be asked of a bridge structure! This indeed was a challenge for the fledgling prestressed concrete industry.

Post-tensioning units were placed in flexible metal ducts and followed parabolic curves in one continuous 225-ft (68.6 m) length up and down over the intermediate supports on the radius of the bridge (Fig. 20). To reduce the dead load and amount of concrete to be cast in one continuous operation, the slab was provided with 9-in. (229 mm) diameter sonovoids placed between the post-tensioning units, spaced 16 in. (406 mm) on center.

At the supports, the slab was cast without any voids. The tops of the columns were built directly into the solid slab.

The 1000 cu yd (765 m³) of concrete required for the entire bridge were cast in one continuous operation from 4:00 a.m. to 5:00 p.m. on a beautiful fall day. The placement of the concrete began with the temperature in the forties (deg F) and was completed with the temperature in the eighties. For the second time, we encountered the problem of thermal air expansion.

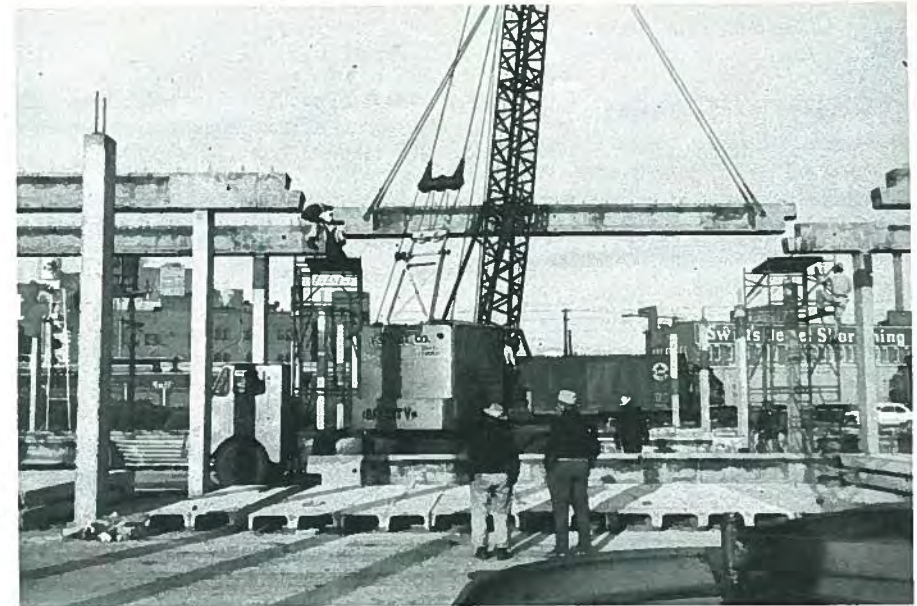

Fig. 21. Double cantilever beams in position, drop-in beams being placed.

The individual sonovoid tubes had tight-fitting end caps on each section, and as the ambient temperature increased and heat of hydration built up, the air in the voids expanded, thereby moving the end caps. Cracks began to appear over the top of the end of each void. Fortunately, the phenomenon was noticed early enough for the concrete to be revibrated and refinished after the air was allowed to escape. Many small cracks were later closed when the prestressing was applied.

To overcome some of the cable friction due to multiple curvature of the units, each unit was stressed from both ends. The units were also overstressed about 10 percent and held for 2 minutes. Additional elongation of the units occurred without application of additional pressure. The tensioning operation was slow, meticulous and tedious, but we managed to obtain the required forces and elongations. Another milestone had been reached on completion of this complicated structure.

Double Cantilever Beams

Innovative designs using prestressed concrete construction continued to appear frequently in Texas in the early fifties. Preston M. Green, a Life Member of ASCE, was the first to use double cantilever prestressed beams supporting prestressed drop-in beams when he designed a large, cold storage warehouse in Ft. Worth (Fig. 21).

This economical design provided long, clear spans with minimum depth to keep the volume of space to be refrigerated to a minimum while providing maximum clear area for palletized storage. The 140 beams were cast on the concrete floor at the job site, post-tensioned, and lifted directly onto the cast-in-place columns.

Precast concrete channel slabs, spanning from beam to beam, were installed at the same time. The 163,000 sq ft (11,580 m²) warehouse with the novel roof structure was completed in only 175 days!

Closing Remarks

There were many setbacks and some sweet successes in the early days of prestressed concrete in the West. Sometimes we felt that the problems of developing a new field were overwhelming, but the excitement and challenge of prestressed concrete was always there and with renewed determination, we continued.

Many people—engineers, architects, contractors, owners, public officials and suppliers—contributed their time, talent and money to make prestressed concrete a successful industry. The use of prestressed products has permitted the economical design and construction of many structures that otherwise might not have been built, or if built, would not have been as efficient or aesthetically pleasing.

The industry has been fortunate to have had so many talented individuals in the design, fabrication and construction of prestressed structures, and we are all thankful that they had the vision and determination to proceed under sometimes very difficult circumstances. Prestressed concrete has not lost any of its glamour, and I am certain that the future will be just as progressive and exciting as the past.

* * *

References

1. Hollister, Leonard, "Prestressed Concrete Design for Arroyo Seco Bridge," *Western Construction*, December, 1950.
2. "The West's First Prestressed Concrete Bridge," *Southwest Builder & Contractor*, April 13, 1951, pp. 69-72.
3. "Erecting the West's First Prestressed Concrete Bridge," *Western Construction*, April, 1951, pp. 76-77.
4. "Simple Prestressing System for Pedestrian Bridge," *Engineering News Record*, May 10, 1951, pp. 40-41.
5. Barton, Robert, M., "Prestressed Bridge," *California Highways & Public Works*, March-April, 1951, p. 3.
6. "Prestress Both Tilt Up Walls and Precast Beams," *Engineering News Record*, January 28, 1954, pp. 48-49.
7. "Four Span Continuous Prestressed Bridge," *Engineering News Record*, July 28, 1955.
8. Gutt, T. J., and Kirk, Don, W., "Prestressed Concrete Warehouse Construction," *The Texas Engineer (ASCE)*, May, June, August, 1955.



Part 6— Early History of Prestressed Concrete in Colorado

by
George C. Hanson, P.E.

Early History of Prestressed Concrete in Colorado



George C. Hanson, P.E.
Consulting Engineer
Denver, Colorado

The important thing is not to stop questioning. Curiosity has its own reason for existing.
Albert Einstein

The history of the development of the prestressed concrete industry in the State of Colorado is one of personal triumph for the individuals who became involved. These men were imaginative and strong in spirit. They shared an enthusiasm and determination which all innovators and pioneers must possess to persevere and be successful.

Much of the technology developed in Colorado was later applied by companies and individuals across the United States to make prestressed concrete versatile and economically competitive with other accepted building materials.

Colorado's contributions to the industry include:

- The formation of Prestressed Concrete of Colorado—the second* pretensioning pre-

stressing company in the United States.

- The development and introduction of the Twin Tee as a roof and floor element in buildings.
- The development of the Twin Tee as a wall element.
- Construction of the first all precast concrete building in the nation built from precast pretensioned prestressed products.
- Fabrication and marketing of component parts for all-precast apartment buildings.
- Development of prestressed

*The first long-line pretensioning bed in North America was built in 1949 by Ben Baskin for Concrete Products of America in Pottstown, Pennsylvania. The Nashville Breeko Block Company in Tennessee began producing in early 1950 block beams which were post-tensioned in the field.

The advent of prestressed concrete in Colorado is described by the author. His account includes development of the "Twin Tee" and its load schedules, and construction of the first all-precast prestressed concrete buildings.

concrete applications to single and multistory structures.

Most importantly, the technology and equipment developed in Colorado was shared with hundreds of companies across the United States, fostering the remarkable growth of the prestressing industry over the past 25 years.

* * *

Little did I know back in the summer of 1951, that my acquaintance with Jack Perlmutter would lead me into an exciting era in the history of construction that would have an impact around the nation.

A project engineer for Phillips-Carter-Osborn, Inc., of Denver, I was working on the Texaco building in downtown Denver when I met Jack, a partner of the construction firm of Perlmutter & Sons, with his father Phil and brother Leonard. Jack and I were on the roof of the building one day when he asked the \$64,000 question—"George, what do you know about prestressing?"

I must admit I had never really thought much about it, and I told him so. But Jack had been thinking about it and I was soon to find out that once he got an idea in his head, he did not let go of it until he had tried everything to make it work.

It was in August of 1951 that the first U.S. Conference on Prestressed Con-

crete was held at Massachusetts Institute of Technology. Apparently, Jack had been noticing articles appearing in trade magazines on the application of prestressed concrete to bridges—among which was the Walnut Lane Bridge. The MIT conference and subsequent proceedings* were the spark which finally convinced him that the possibilities for prestressed concrete were unlimited, especially in its applications to buildings.

At that time John A. Roebling's Sons Corporation was producing strand back in New Jersey. The one and only pretensioning bed in the United States also happened to be located near New Jersey. The plant, in Pottstown, Pennsylvania, was producing bridge girders, but we thought a tour of the plant would help us design a plant to produce other prestressed members. We decided to go to New Jersey to find out all we could about prestressing.

Jack's father and Orley Phillips, my boss, agreed to turn us loose on New Jersey figuring after a month or two we would probably get the idea out of our systems. Little did any of us know that Jack and I would return from New Jersey 1 week later with 3000 ft (915 m) of strand, ordered for our first trial fabrication of pretensioned members. It was the

*Proceedings of the First United States Conference on Prestressed Concrete, Massachusetts Institute of Technology, Cambridge, Massachusetts, August 14-16, 1951, 256 pp.

The Author

George C. Hanson has been extensively involved in structural engineering design since 1945, when he joined Denver engineering firm Phillips-Carter-Osborne, Inc. He contributed design criteria for precast prestressed members, from fabrication to construction application, to the young prestressing industry. He also developed load tables and brochures on various precast prestressed members.

Mr. Hanson graduated from the South Dakota School of Mines and Technology with a BS in civil engineering. In 1953, he was awarded the professional degree of Civil Engineer for his pioneering work in prestressed precast concrete.

He was national director of the PCI from 1961 to 1963 and has served on several PCI committees including the Detailing and Technical Activities Committees. He was a member of the Chapter 26 Building Code Advisory Committee, and member and chairman of the Board of Appeals for the City and County of Denver.

Mr. Hanson has presented several papers on prestressed concrete application at PCI conventions and various seminars. He won the Building Industry Conference Award from the University of Colorado in 1951 through 1956 for his developmental work in prestressed concrete.

Mr. Hanson is a registered professional engineer in 13 states. He has been with the consulting engineering firm of Sallada-Hanson since 1957, and recently became associated with the Denver-based architectural firm Flickinger Associates to develop an engineering department.

beginning of a multimillion dollar industry in Colorado.

Jack had called Nelson Hicks, an enthusiastic and knowledgeable salesman for Roebing, and convinced him to meet with us. On a snowy morning in October 1951, we packed into the car and headed east. Not many sensible men begin a 2000-mile (3220 km) automobile trip in a snow storm and I suppose this was when I realized that nothing stands in the way of a man with the determination of a Jack Perlmutter. But 3 days later we were in New Jersey where Jack met with Nelson Hicks and Pat Patterson (also a very competent sales engineer with Roebing).

At this time I was introduced to H. Kent Preston, an engineer at Roebing, a man for whom I would soon develop an enormous respect. Kent was instrumental in our endeavor to research, develop, and market prestressed concrete in Colorado. He was one of the most competent and knowledgeable men in the industry and probably contributed more to the development of prestressing in Colorado and the nation than anyone in the industry.

After our appointment with Roebing and our tour of the Pottstown plant, Jack Perlmutter and I returned to Colorado with 3000 ft (915 m) of $\frac{5}{16}$ -in. (≈ 8 mm) diameter strand with the intention of building two bonded prestressed beams for testing. We never got a chance to test the strand, however, because our first prestressed member was to be applied to a truck transfer dock that Perlmutter and Sons had won a contract to build. With no experience to back us we were apprehensive, but our enthusiasm and confidence never allowed us to doubt that prestressed concrete could be applied to building construction.

In addition to its construction company, Perlmutter and Sons had a brick and concrete pipe manufacturing plant (Fig. 1). It was in the storage area of this plant that we built our original pretensioning bed, the first of its kind in the

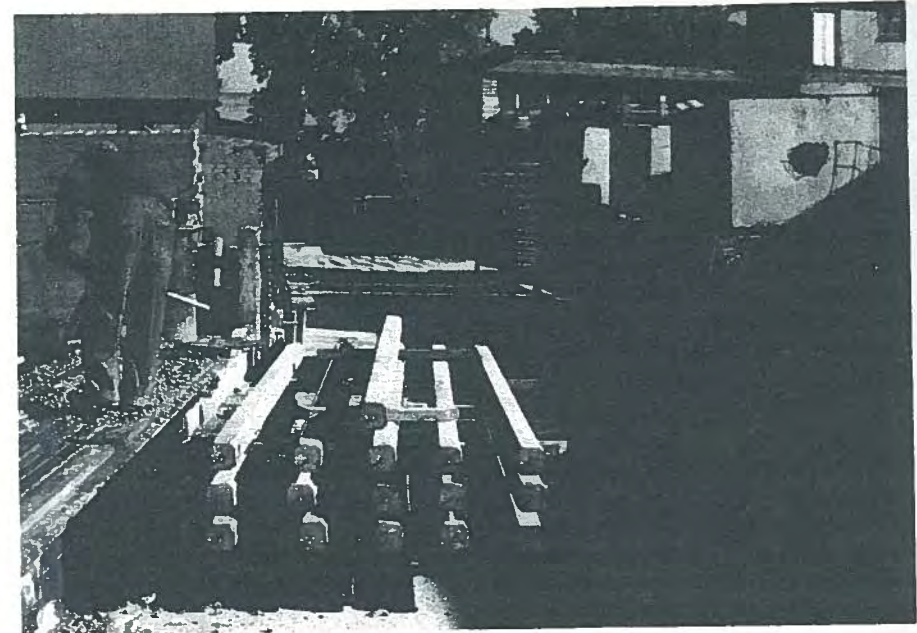

Fig. 1. Prestressed fence posts were among the first products produced by Prestressed Concrete of Colorado on their original 50-ft (15.2 m) bed built early in 1952.

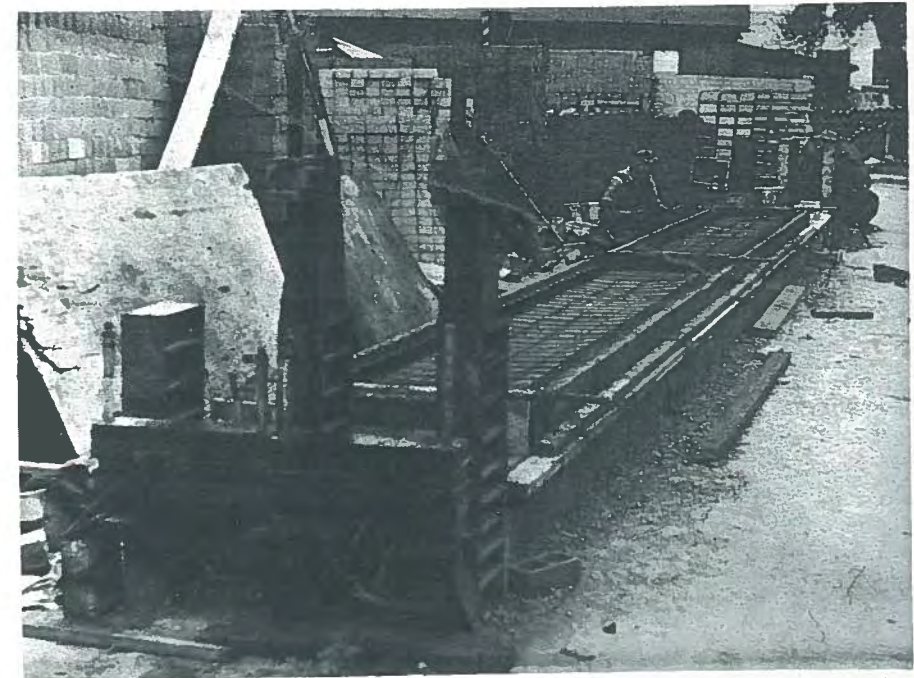

Fig. 2. Forms and reinforcement are placed in Colorado's first pretensioning bed prior to casting channel slab.

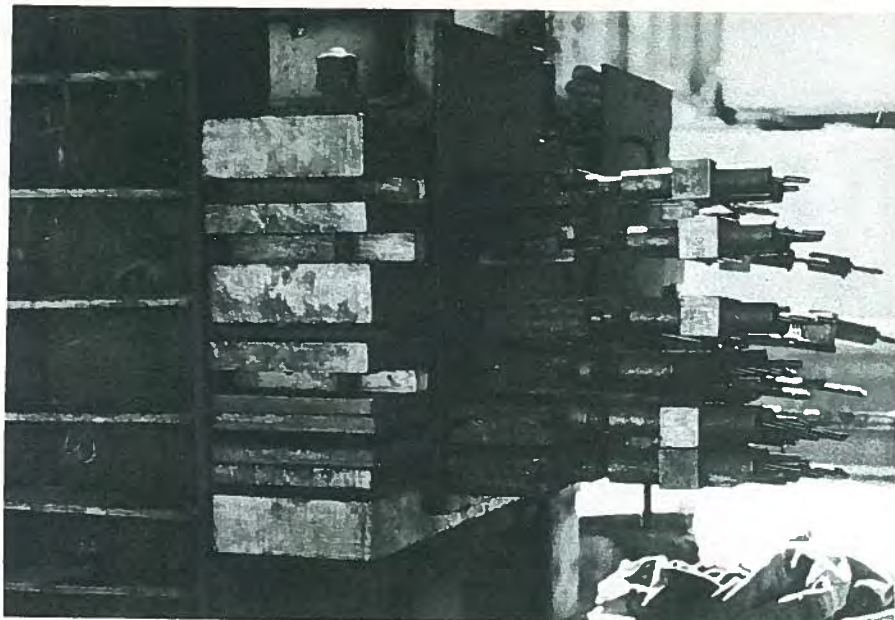

Fig. 3. The tensioning end of Prestressed Concrete of Colorado's original 50-ft (15.2 m) bed with the strand tensioned.

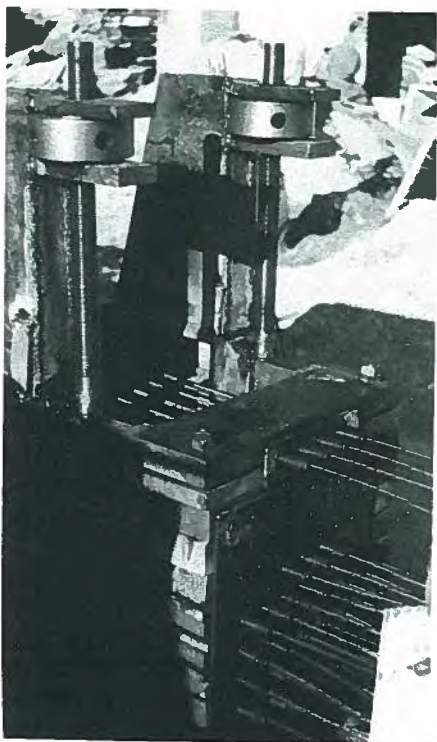

Fig. 4. The dead end of Prestressed Concrete of Colorado's original bed, with the strand tensioned. The threaded rod and circular portion at the top was used for vertical adjustment at the dead end. Present day anchoring and support methods are very similar.

United States, to produce members for building construction (Fig. 2). I managed to put together a design using some rough design specifications from Kent Preston. Our first bed was 48 ft (14.6 m) long with anchors at either end capable of resisting total stresses up to 175 tons (160 t) (Figs. 3 and 4). The casting surface itself was a 48-ft (14.6 m) concrete slab cast over continuous channels that were integral with the built-up structural steel anchorages. A 60-ton (54 t) hydraulic jack was used to stress two 7-wire strand at one time.

Our work with prestressed concrete became a contagious passion and soon

Fig. 4. The dead end of Prestressed Concrete of Colorado's original bed, with the strand tensioned. The threaded rod and circular portion at the top was used for vertical adjustment at the dead end. Present day anchoring and support methods are very similar.



Fig. 5. Jack Perlmutter (right) and Michael Altenberg were among many men who worked day and night on Prestressed Concrete of Colorado's first pretensioning bed. The original 50-ft (15.2 m) bed was the beginning of the remarkable growth of prestressed concrete fabrication in Colorado.

everyone was working day and night on its development (Fig. 5). Orley Phillips and Phil Perlmutter treated the new material like a child treats a new toy. Our dabbling in prestressed concrete applications to buildings became a seven-day-a-week venture and no one was afraid to get their hands dirty.

The pretensioning bed was completed by January of 1952 and we began producing modified prestressed I-beams which would be substituted for steel beams on the truck transfer dock. Jack Perlmutter knew the Rudd Brothers who owned the building where these roof beams were to be applied, and they readily accepted the substitution of prestressed concrete.

At this time, prestressed concrete was a wonder material in Colorado and held a great fascination for many people. Questions were few because no one knew enough about it. We built five

beams designed with the help of Kent Preston. Until this time, prestressed beams had only been designed for bridge application in the United States, so we had to improvise to make the design applicable to building structures.

I arrived at the dimensions of the beams by the limiting conditions of the structure. I scaled down the 7 x 6-in. (178 x 152 mm) beams so they could be cast in the same form where we cast the 8 x 17-in. (203 x 432 mm) beams.

According to my calculations, the diagonal tension in the girders was over the allowable for 5550-psi (38.3 MPa) concrete. I was not sure if the excess drag tension could be taken by wire mesh or if stirrups had to be fabricated. Kent advised us that either could be used. He also found my calculations to be on target, a great relief to me.

When the beams were set, we load tested one ourselves, piling sacks of

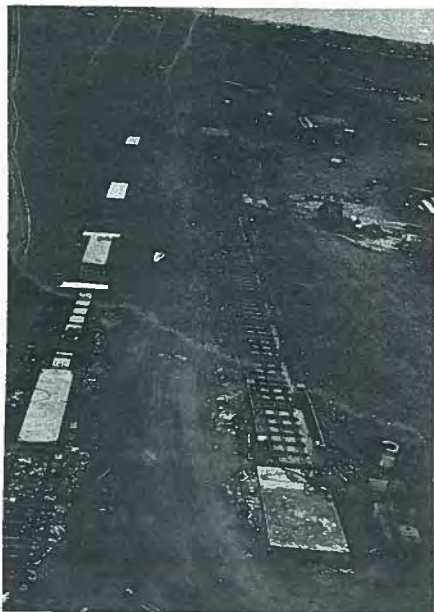

Fig. 6. Late in 1952, Prestressed Concrete of Colorado built its first production prestressing bed. (Note: Twin Tee slabs stored to left of bed.) The original 50-ft (15.2 m) bed, built in 1951, proved inadequate for economical production purposes.

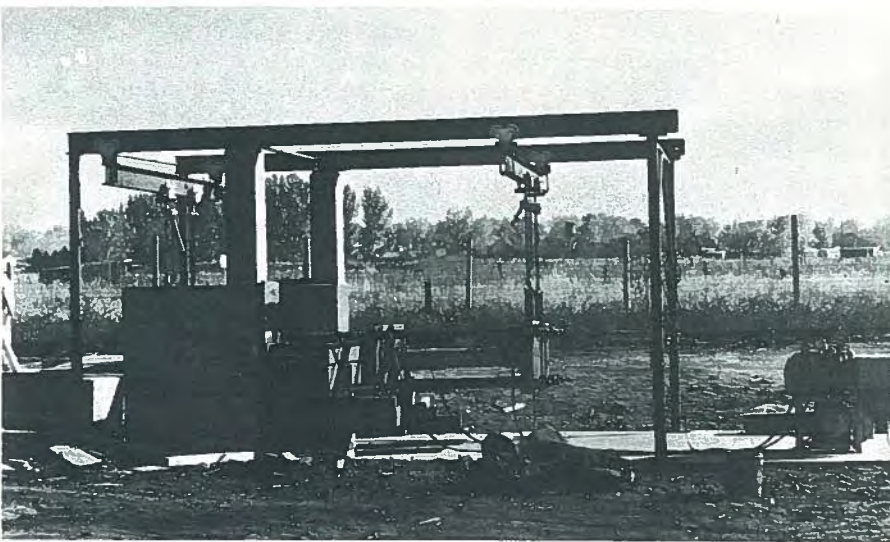

Fig. 7. A one million pound (4450 kN) stressing capacity was possible by the use of two, 250-ton (227 t) jacks with an elongation of 48 in. (1219 mm).

cement on top of the beam until we could not reach any higher. The cement weighed over 18,000 lbs (80 kN), four times the design load. We were successful, and the five 18-ft (5.5 m) beams were erected to support the transfer dock portion of the 55 x 130-ft (16.8 x 39.7 m) building.

Needless to say, we were concerned over our first application, but the test results were most rewarding. It took 3 days to produce one beam and the work required was phenomenal compared to what it is today.

We had no idea what it would cost to develop even a primitive plant and within the first few months, we knew we were way off on our original estimated investment.

But rather than discouraging Jack Perlmutter, it inspired him to develop the equipment and methods that would eventually make prestressed concrete competitive with other construction materials. To do this, we had to make the most efficient use of our forms. This required improvisation and testing that were both frustrating and costly.

Being convinced of prestressed concrete's capabilities, Phil, Jack, and Leonard Perlmutter incorporated Prestressed Concrete of Colorado early in 1952. At this point, the original 50-ft bed in the storage area was not enough. A larger plant was needed which could produce a higher volume of products. We selected a site and knew there would be no turning back (Fig. 6).

Versatility and speed of production were of primary importance in the design of a new casting plant. With these objectives in mind, I helped design a casting bed 280 ft (85.4 m) long and 10 ft (3.05 m) wide, built with intermediate end anchorages spaced at 20-ft (6.1 m) intervals.

Portable anchorages were dropped behind these. Jack developed a tensioning mechanism capable of tensioning sixty $\frac{5}{16}$ -in. (8 mm) strand or forty $\frac{3}{8}$ -in. (10 mm) strand in one operation through the use of two hydraulic jacks capable of stressing up to 300 tons (272 t) (Fig. 7).

A \$3500 coal-burning steam boiler was installed with a steam main running the length of the casting bed. Multiple valves along the main provided complete flexibility for curing individual units or the full capacity of the casting bed. It cost us \$200 per month to run the steam curing operation 6 days a week.

During the early operation of the plant, all concrete materials were batched at a central batching plant, mixed and delivered by transit mix trucks. This procedure was soon revised by installing a paddle-type mixer at the batch plant and delivering concrete by mobile concrete-lift buggies.

Aware that time was money, Jack used a dry concrete mix [seldom exceeding a 1-in. (25 mm) slump (Fig. 8)] and steam curing to produce a high-early-strength concrete. Using a standard Type I portland cement, Prestressed Concrete of Colorado attained a minimum compressive strength of 6000 psi (41.4 MPa) in 24 hours—an

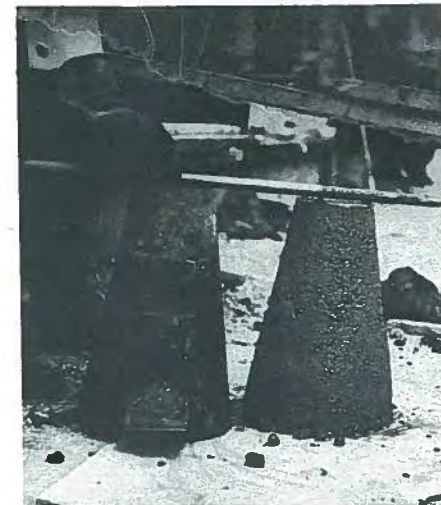

Fig. 8. A slump cone of the concrete used to fabricate the first prestressed members in Colorado showed negative slump.

unusually high strength for that time (1952).

This high early strength, coupled with an efficient operation, allowed Prestressed Concrete of Colorado to cast over 1500 sq ft (140 m²) of roof members on one bed each day. We had one 20-ton (18 t) mobile crane to lift units from the bed to temporary storage or hoist on trailers. Because there were no acceptable standard load tests established for prestressed concrete, we designed and built a test bed capable of testing full-sized units up to 60 ft (18.3 m) in length with a maximum load of 275,000 lbs (1220 kN).

Late in 1952, Prestressed Concrete of Colorado developed and introduced the double-tee slab which it marketed under the copyrighted name Twin Tee. (Fig. 9).

Nat Sachter, the architect for a cold storage warehouse for Beatrice Foods, conceived the idea of adapting the double-tee from existing channel slab designs (Fig. 10). Nat, who eventually joined Prestressed Concrete of Col-

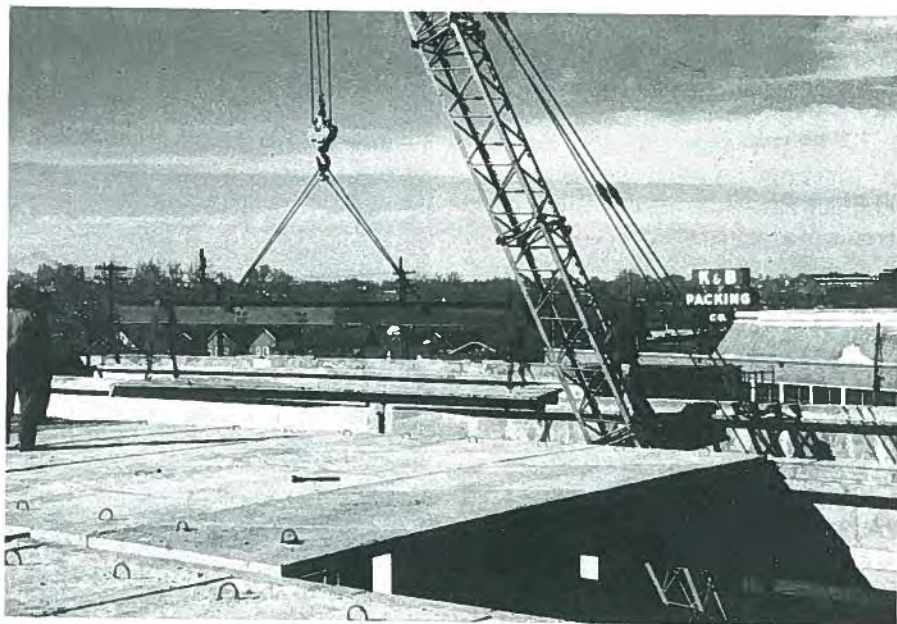

Fig. 9. In 1952, Prestressed Concrete of Colorado developed the double-tee, which they marketed as the Twin Tee, for a cold storage warehouse for Beatrice Foods.



Fig. 10. A 6-ft (1.83 m) wide double-tee was developed from existing channel slab designs to allow larger spans between beams in the cold storage warehouse for Beatrice Foods.



Fig. 11. A single-tee slab is lifted off the bed ready for transport to the Spitzer Electric Company.

orado, applied a 6-ft (1.83 m) wide double-tee to allow larger spacings between beams to promote air circulation and protect against icing in the refrigerated storage building.

The most widely used span of the double-tee was from 20 to 25 ft (6.1 to 7.6 m). Prestressed Concrete of Colorado's concern with efficiency and function resulted in one of the most innovative contributions to the industry.

By 1953, Prestressed Concrete of Colorado was manufacturing prestressed concrete units for building roof systems. The extent of the roof systems varied from supporting beams for wood or lightweight slabs to the complete roof systems of long-span, precast prestressed slabs or precast prestressed beams and slabs.

Note that by this time prestressed concrete members had been produced and applied to the first roof parking deck structure at the Spitzer Electric Com-

pany (Figs. 11, 12, and 13). The clear span of the beams varied from 17 to 80 ft (≈ 5 to 24 m). The beams had a rectangular cross section or a typical I-shaped cross section with variations of the I-section (Figs. 14, 15 and 16).

It was in 1953 that Prestressed Concrete of Colorado became the first company in the nation to apply prestressed concrete units to a school using pre-tensioned precast channel slabs.

At this time, slab designs were of three major types: a channel-shaped cross section in which the two webs were designed to support the load with the flange spanning between the webs, a single-tee and the double-tee. Channel slabs with a cantilever at the end were also used in the Loveland School. They were produced in varying lengths which required that the forms be rebuilt for each length.

We transported the slabs 50 miles (80 km) to the site with four trucks. Erection

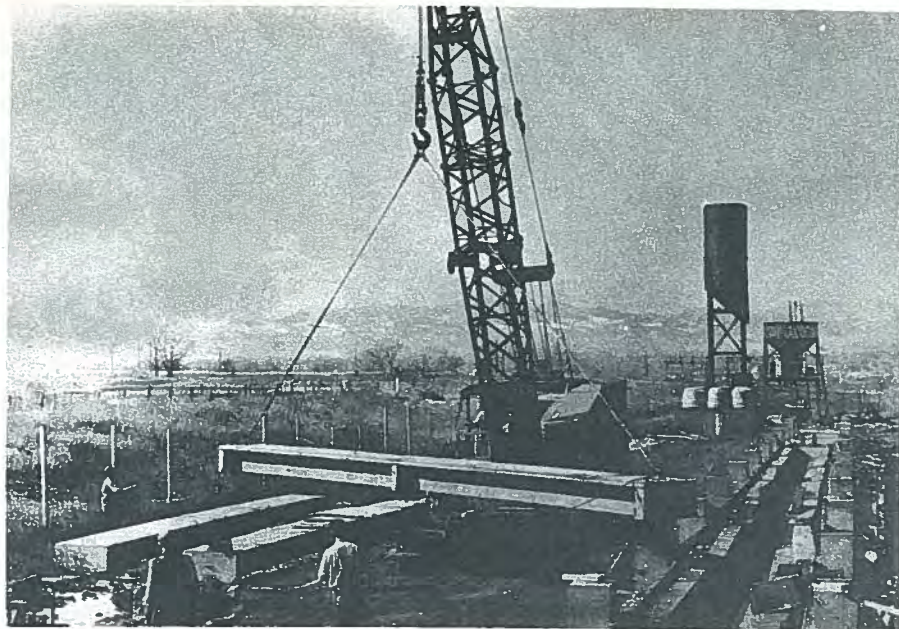

Fig. 12. The end block and diaphragm block of a single-tee slab for the Spitzer Electric Company were cast compositely.

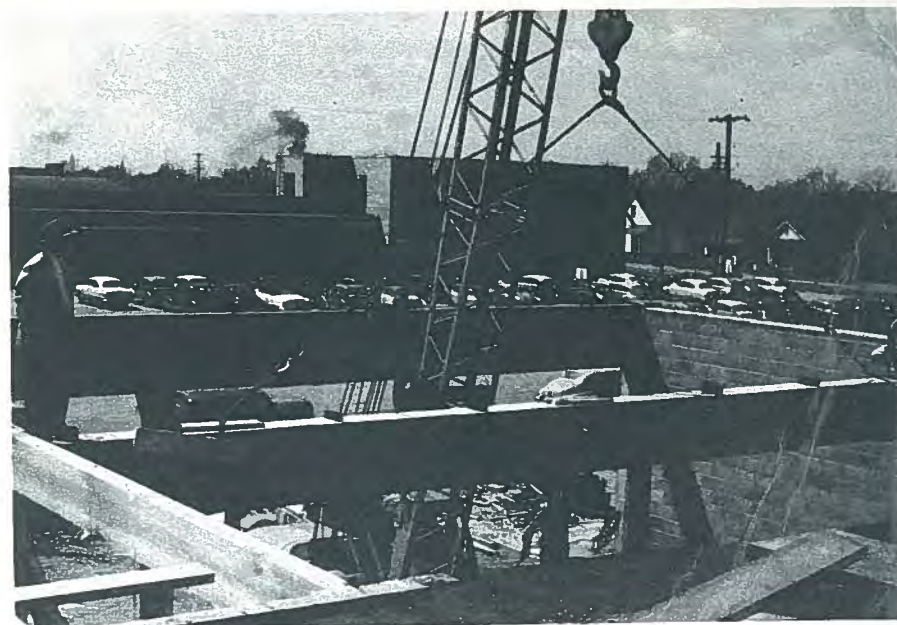

Fig. 14. The largest prestressed beam in Colorado made by Prestressed Concrete of Colorado was for the Plat Packing Plant in 1952.

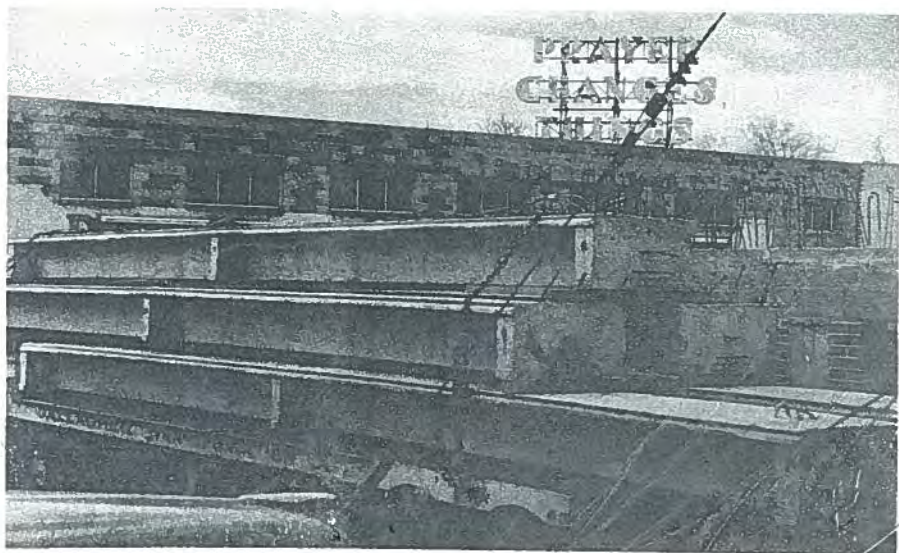

Fig. 13. The significance of the statement "Prayer Changes Things" looming in the background to the development of the prestressed concrete industry in Colorado has yet to be determined. Single-tee slabs await transport to the Spitzer Electric Company.

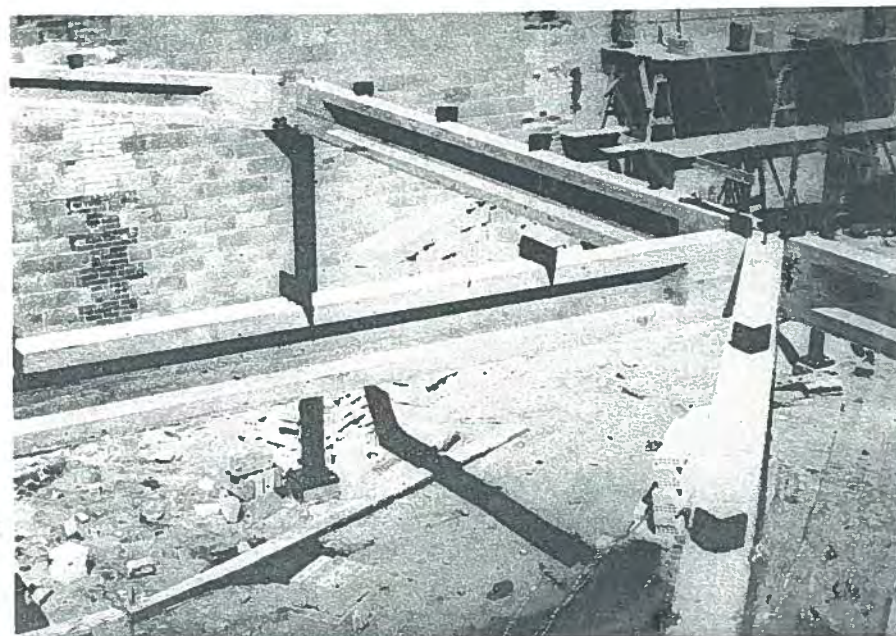

Fig. 15. Four beams merge into one column at the Plat Packing Plant.



Fig. 16. Working around the tolerances of concrete, Prestressed Concrete of Colorado connected four beams into one column.

time on the job averaged about 15 minutes per slab due to the end construction of the slabs and the close tolerances that were maintained. Placing other slabs 5 ft 8 in. (1.75 m) wide and 23 ft (7 m) long at an average time of 5 minutes per slab, allowed us to erect 130 sq ft (12 m²) of total roof area every 5 minutes.

The average cost per square foot of the roof area for the Loveland school was \$1.52. This cost included manufacturing, transportation and erection of all the prestressed concrete roof slabs. At that time these costs compared very favorably with other equivalent types of construction.

In August of 1953, we expanded the plant to accommodate the casting of a test slab for the Association of American Railroads. This slab would be tested in the Bureau of Reclamation laboratories together with other reinforced concrete slabs for comparative results. It was one

of the most heavily stressed concrete members ever cast by Prestressed Concrete of Colorado. The slab was 19 ft (5.8 m) long, 6½ ft (2 m) wide, 18 in. (457 mm) thick and weighed 28,500 lbs (127 kN). It had sixty-seven 7-wire ½-in. (13 mm) steel strand.

Early in the development of the industry in Colorado, Prestressed Concrete of Colorado began working closely with Gene Nordby, at the time assistant professor of civil engineering at the University of Colorado, to test the behavior of prestressed concrete under fatigue, impact and repeated loading.

We dealt primarily with strand-type prestressing. We wanted reassurance since we were not sure how our prestressed concrete unit would act after several years of wear and tear. Contributing materials for testing were Ideal Cement, Prestressed Concrete of Colorado, and John A. Roebing's Sons Corporation.

Professor Nordby developed a fatigue machine with a 3 hp (2.24 kW) motor with speeds controlled by an old Studebaker automobile transmission. We load tested six beams at 6-second intervals around the clock. Three beams were tested to destruction. Early tests showed no substantial decrease in the bonding action between the wire and the concrete after one million load repetitions.

In the spring of 1953, Roebing gave national recognition to the achievements of the prestressing industry in Colorado through an advertisement it ran in *Civil Engineering and Engineering News Record*. Our work was detailed in a two-page spread filled with pictures of the production plant and erection operations (see Fig. 17).

Our satisfaction was immense and soon after the advertisement appeared, phone calls and letters arrived weekly from companies across the nation which were interested in beginning prestressed concrete operations. Roebing received quite a few requests for more information on prestressed concrete, and Kent Preston finally wrote to me requesting drawings of a typical roof design using concrete girders, purlins, slabs, and channels.

Soon after the advertisement appeared, *Western Construction* asked me to write an article detailing several projects by Prestressed Concrete of Colorado. After the article was published in August, 1953, we received even more letters requesting a tour of our plant.

We were more than happy to accommodate the wishes of these individuals interested in prestressed concrete. From my own experiences in prestressing, I knew architects and engineers with little experience in prestressing could not become sufficiently educated in the field entirely from published literature. They needed to learn from conversations with those involved in the industry. They needed to tour the production plant and see the operation for themselves.

When I was asked to speak at Oklahoma A & M's Fifth Annual Concrete Conference Program in January, 1955, I felt it was important to detail the peculiarities of prestressed concrete which had to be considered before a design or fabrication could be attempted. As in any new industry, skeptics waited off-stage for our failure, to prove their doubts about prestressed concrete. A serious miscalculation meant a setback for the industry.

The risk of prestressing was large for all of us for many years, and the industry is to be praised for its conscientious and thorough approach. Using what proven principles were available, we made our designs, fabricated the members, and erected them, sometimes rather clumsily, with the cranes that were then available (Fig. 18).

We spent hours with prospective or newly-involved producers of prestressed concrete at our plant, detailing our achievements, our setbacks, our frustrations, and our aspirations. The satisfaction for all of us was enormous.

An immediate bond was developed as we greeted these young, innovative and daring men who believed in the possibilities of prestressed concrete. The Perlmutter had always been a most hospitable family, and we spent many evenings with our visitors talking into the morning hours about our industry's concerns. We developed some lasting and satisfying relationships with these men.

After visiting Denver, many of these men returned to their states and built their own prestressing plants. Shortly before the plants were to begin operations, Prestressed Concrete of Colorado offered, for a very minimal charge, the prestressing production expertise of Bill Loper, supervisor of its plant.

Bill travelled across the nation spending several weeks at each plant helping to train personnel and aid with the initial production for the plant. I often followed, reviewing design specifications of the prestressed members to be produced.

PRESTRESSED CONCRETE



1 Plant of Prestressed Concrete of Colorado, Inc., includes a 280-ft. casting bed, 10 ft. wide. Two hydraulic jacks have a total stressing capacity up to 300 tons. Photo shows forms for a "T" beam in place on the bed.

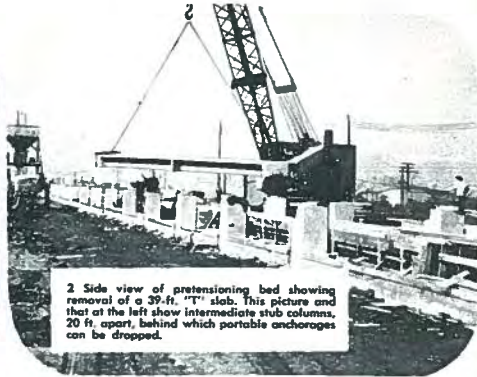

2 Side view of prestressing bed showing removal of a 39-ft. "T" slab. This picture and that at the left show intermediate stub columns, 20 ft. apart, behind which portable anchorages can be dropped.

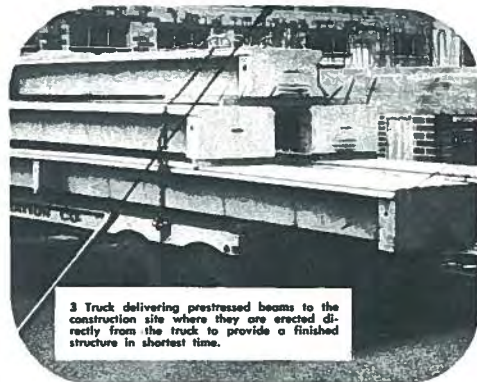

3 Truck delivering prestressed beams to the construction site where they are erected directly from the truck to provide a finished structure in shortest time.



4 Erection of a 39-ft. "T" slab during building construction. Crane placed slab over wall of ramp. Then "A" frame lifted one end while crane lifted other to swing slab in place—a method necessitated by insufficient bearing for crane outriggers in alley.

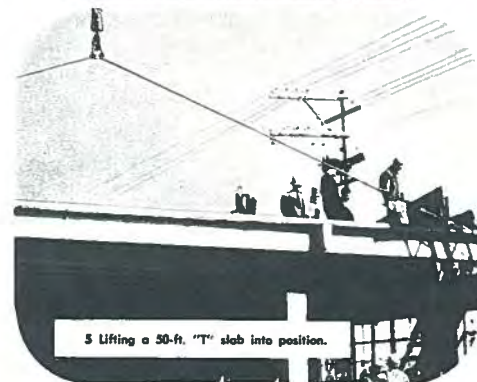

5 Lifting a 50-ft. "T" slab into position.

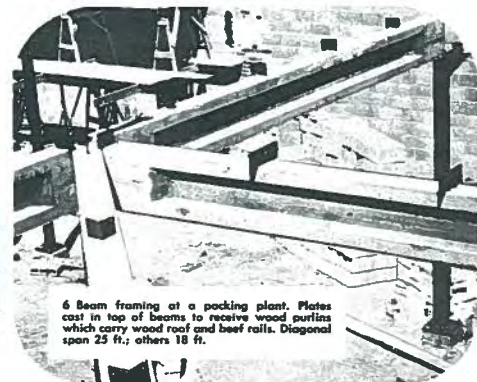

6 Beam framing at a packing plant. Plates cast in top of beams to receive wood purlins which carry wood roof and beef rolls. Diagonal span 25 ft.; others 18 ft.

PRODUCTION LINE!

Single plant quickly reached daily volume of 1120 ft. of structural members to meet demand

ALMOST UNLIMITED POSSIBILITIES await the fabricator of prestressed concrete structural members. One of the first in this field, Perlmutter & Sons Co., of Denver, built a 48-ft. casting bed as a pilot plant. They cast a wide variety of shapes and sizes and learned the angles. Then, as Prestressed Concrete of Colorado, Inc., they built a 280-ft. casting bed. Completed last October, this plant produced 560 linear ft. of beams, girders, roof and floor slabs daily. By February this was increased to 1120 ft.

By June 1, 1953 Prestressed Concrete of Colorado had supplied 130,347 sq. ft. of 100% prestressed concrete roof plus beams to support an additional 25,700 sq. ft. of wood and lightweight slab.

Both casting beds were designed by Phillips-Carter-Osborn, Inc., of Denver, after consultation with Roebing. Six different architectural firms in the area have employed them to design the prestressed concrete members for many structures including the three illustrated on these pages.

Roebing has pioneered in adapting the principles of prestressed concrete to American practices. Roebing is a major supplier of strand for pretensioning—in Regular and SR (stress-relieved) grades—and of end fittings and strand for post-tensioning.

Based on its experience in this field, Roebing can furnish data and suggestions on the design and operation of plants for fabricating prestressed concrete structural members. Inquiries will be welcome from everyone interested in building such plants and in capitalizing on the most revolutionary and profitable trend since structural steel came into the picture. Prestressed concrete compares favorably with steel cost-wise, and its unique advantages assure a practically unlimited future.

Architects, engineers and builders are invited to write for the Roebing prestressed concrete story.

Address Prestressed Concrete Dept.
JOHN A. ROEBLING'S SONS CORPORATION
 Trenton 2, New Jersey
 A subsidiary of The Colorado Fuel and Iron Corporation



ATLANTA, 924 AVON AVE. • BOSTON, 51 SLEEPER ST. & B. PITTSBURGH ST. • CHICAGO, 5825 W. ROOSEVELT RD. • CINCINNATI, 3253 FREDONIA AVE. • CLEVELAND, 13233 LAKEWOOD HEIGHTS BLVD. • DENVER, 4801 JACKSON ST. • DETROIT, 915 FISHER BLDG. • HOUSTON, 5216 NAVIGATION BLVD. • LOS ANGELES, 5040 E. HARBOR ST. & 120 S. HEWITT ST. • NEW YORK, 19 RECTOR ST. • ODESSA, TEXAS, 1920 E. 2ND ST. • PHILA., DELPHIA, 200 VINE ST. • PITTSBURGH, 1901 CLARK BLDG. • ROCHESTER, 1 FLINT ST. • SAN FRANCISCO, 1740 19TH ST. • SEATTLE, 900 1ST AVE. S. • ST. LOUIS, 3001 DEL MAR BLVD. • TULSA, 321 N. CHEYENNE ST. • EXPORT SALES OFFICE, TRENTON 2, NEW JERSEY

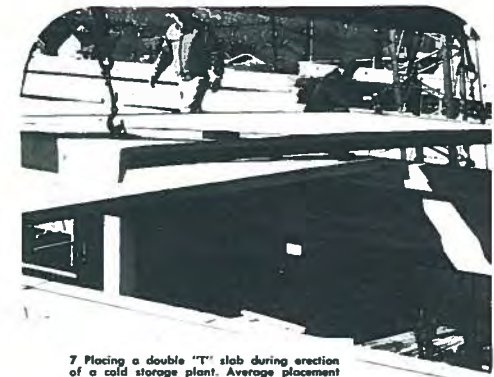

7 Placing a double "T" slab during erection of a cold storage plant. Average placement time was three minutes per slab.

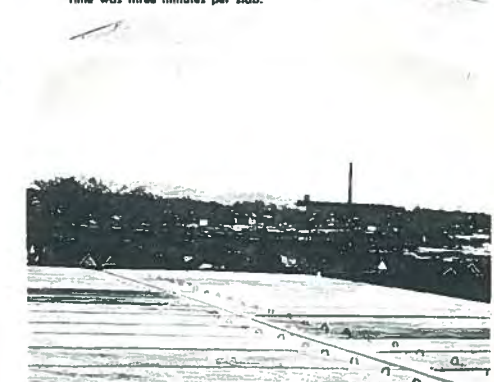

8 Same as above. Top view of slabs in place before the lifting hooks were burned off.

Fig. 17. John A. Roebling's Sons Corporation advertisement featuring Prestressed Concrete of Colorado plant and erection operations.

Fig. 17. (cont.) John A. Roebling's Sons Corporation advertisement featuring Prestressed Concrete of Colorado plant and erection operations.

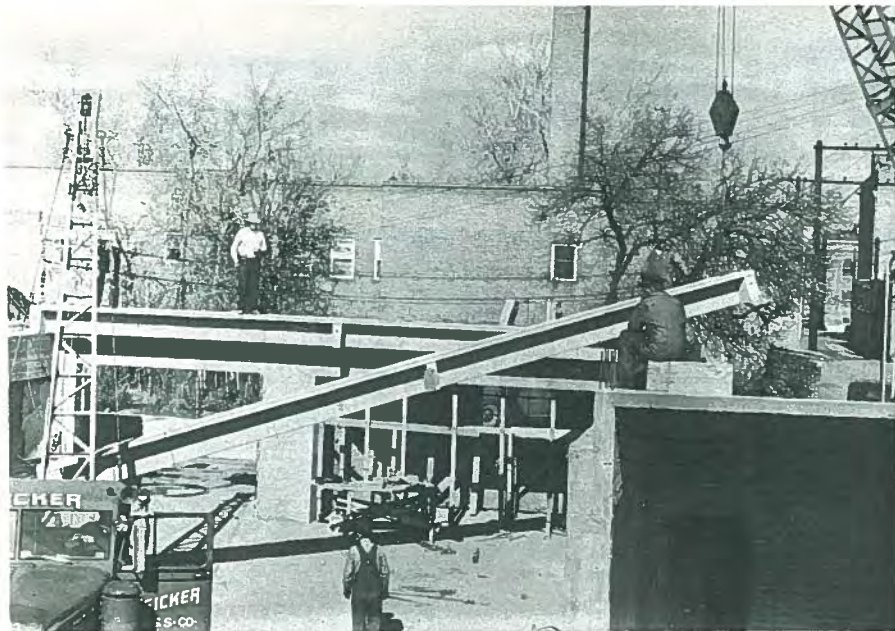

Fig. 18. Ingenuity was required in every phase of early prestressing. Here, erection of a single-tee slab was accomplished by a makeshift crane lifting the slab over the wall. An A-frame then "walked" one end of the slab into place while the crane maneuvered the other end into place.

Jack Perlmutter felt that the growth of the industry as a whole was imperative to the industry's growth locally. Visitors were welcomed into the plant, cameras and all. There was nothing to hide, only technological progress to share, to discuss, to attempt to improve upon.

In retrospect, I believe the industry would be 10 years behind without the knowledge developed in Colorado and shared with the rest of the nation by experts such as Bill Loper, now senior vice-president of operations for Stanley Structures.

Most importantly, we competed with ourselves. We knew that to make progress, we had to remain a forerunner in the industry. The Coloradoans had the drive and imagination to improve the fabrication process, the product, and expand its application. When the industry was beginning in Colorado in 1951,

commercial grips were not yet available to clamp the strand to retain pressure from the jack (Fig. 19).

Jack Perlmutter decided to devise a clamp which could be effective and reusable. Because the steel we were clamping on was so hard, Jack worked to develop a grip that was harder than the prestressing strand. Kent Preston gave him the slope for the collet and the grips and we experimented with Maxel 3½, a high-grade steel.

We heat treated the exterior collet and grips, but found the anchor still broke. We then case hardened the collet and heat treated the grips. We found a solution, though it was relatively expensive for us to produce (Fig. 20).

When this type of anchor became available commercially, we purchased it from a supplier. In the interim, however, we used our anchor effectively and re-

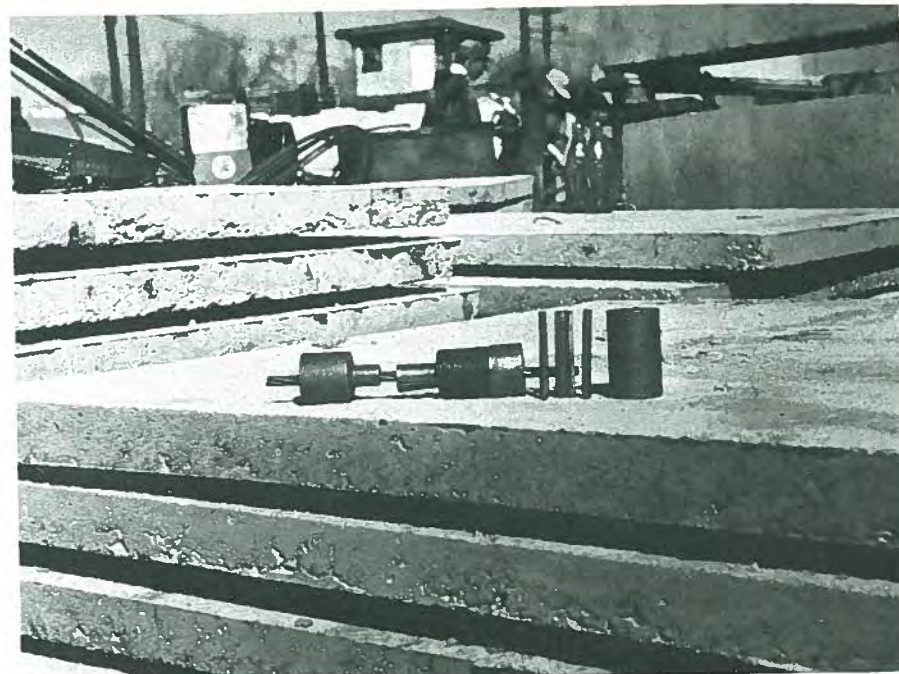

Fig. 19. An assembled collet to grip strand (left) consisted of the collet cuff and jaws (right).

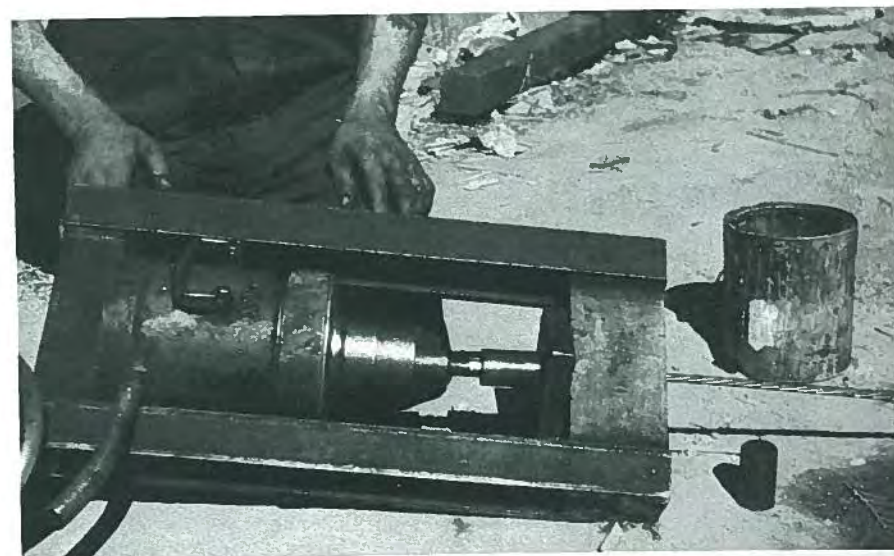

Fig. 20. This machine, developed by Jack Perlmutter, not only set the collet on the strand prior to placing it in the bed but was also used to remove the jaws and the leftover strand from the collet.

ceived several requests from prestressers around the country wanting to purchase it.

In 1953 we were greatly honored when Paul Rogers, structural engineer with Rogers & Snitoff, Inc. of Chicago, wrote to us on behalf of Dr. Paul W. Abeles, British pioneer on prestressed concrete, for any helpful contributions to his book on prestressed concrete. The capabilities of prestressed concrete were being realized around the nation and by Denver area builders, and in 1957, a second prestressing company was born in Colorado, namely, Rocky Mountain Prestress.

In February of that year, Craftsman Construction Company of Denver won the contract for construction of two high schools in Denver, each costing approximately \$2 million. By using prestressed concrete, Craftsman could reduce costs of the schools about \$1 per sq ft. By producing also the concrete itself, the contractor could realize an even greater savings.

At the Wheat Ridge school, five post-tensioned beams, each 113 ft (34.5 m) long and weighing 62 tons (56 t) were erected to support a huge gymnasium roof. It was the biggest post-tensioned concrete beam job ever attempted in the area. Craftsman used two 50-ton (45 t) mobile cranes to erect the beams which had been cast in forms on the ground of the gym floor.

After the 6-ft (1.8 m) deep beams were cured for two weeks, they were hoisted onto 22-ft (6.7 m) concrete columns spaced 28 ft (8.5 m) apart. The same forms were then transferred to the site of the second school where an identical gymnasium was erected. Soon after the schools were completed, Rocky Mountain Prestress was formed by Frank Hall and his associates.

The competition which evolved between Prestressed Concrete of Colorado and Rocky Mountain Prestress boosted the industry in Colorado. Though prestressed jobs had always been bid com-

petitively, the existence of two companies alleviated any hesitations architects or contractors had relative to price or production capabilities which, at that time, were limited to one supplier.

The two companies worked together to promote the use of prestressed concrete as a viable structural material and make it available to the construction industry. Together, we gained the respectability and acceptance of prestressed concrete which led to its phenomenal growth in the Rocky Mountain area.

In November, 1954, I wrote to Thor Germundsson at the Portland Cement Association as I was curious about the development of prestressed concrete around the nation. Adding up individual jobs, large and small, Thor arrived at the following number of prestressed concrete jobs which had been completed since 1950. It was obvious the industry was progressing:

1950— 10 projects
1951— 15 projects
1952— 80 projects
1953—100 projects
1954—175 projects

In 1957, when the double-tee was becoming an integral component of prestressed concrete buildings, I determined a load schedule for it. Unlike the Speedgraphs published in 1967 by Prestressed Concrete of Colorado, which were determined with the aid of a computer, my calculations were time consuming; but necessary, to promote and market the use of the double-tee.

Also during this period, post-tensioned applications were incorporated with a pretensioned system to allow more efficient use of the facilities for the production of prestressed units. Large and small roof beams and bridge construction elements were made available. Post-tensioned elements were provided with the pretensioned elements (Figs. 21 through 24).

It was in 1961 that Jack Perlmutter developed and engineered a machine



Fig. 21. Jean Muller, a welcome visitor to Prestressed Concrete of Colorado, takes a break on the support rails of the jacking assembly.



Fig. 22. Post-tensioned beams were cast on site at the Star Bakery because of the limitations of existing transportation equipment.



Fig. 23. In 1956, precast single-tee sections for a viaduct were made at Prestressed Concrete of Colorado's second pretensioning plant and transported to the site.



Fig. 24. Post-tensioned box girders on which pretensioned slab sections were placed. Topping was cast over the top of the deck section to provide a composite deck with girders and pretensioned slab sections.

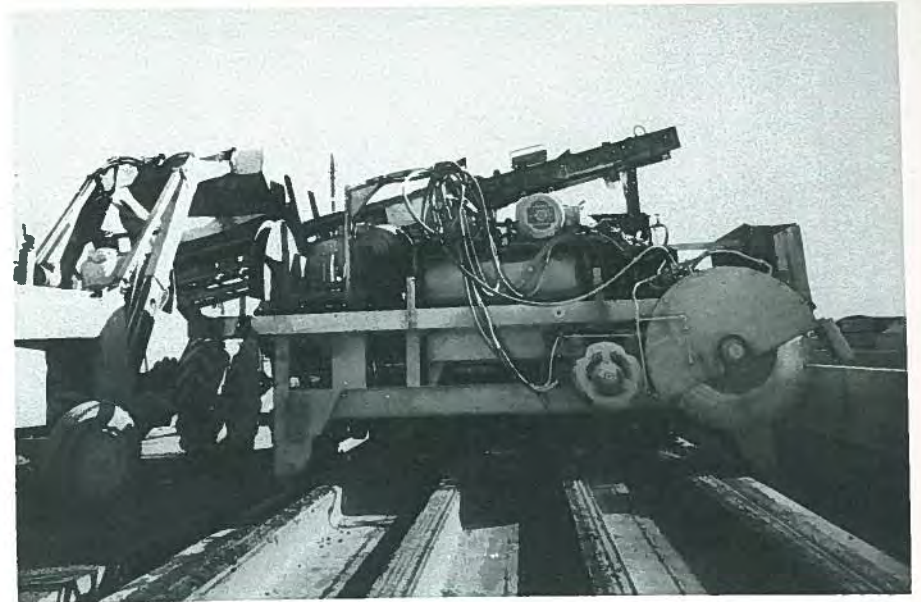

Fig. 25. In 1961 Jack Perlmutter developed a hydraulically-operated horizontal slip form machine to cast a Quadeck, an inverted tee slab with four stems. A front end loader charged the hopper on the Quadeck slip form.



Fig. 26. After the concrete set, the Quadeck was cut to size by a saw attached to the machine.



Fig. 27. In the final operation, concrete is placed and finished over the form board covering the Quadeck.

for construction of a Quadeck, an inverted tee slab with four stems (Fig. 25).

The hydraulically-operated horizontal slip-form machine was much like a vertical slip-form machine. After the concrete set, the Quadeck was cut to the desired lengths by a saw attached to the machine (Figs. 26 and 27).

The machine was masterfully engineered, though it was costly to build at the time.

For a number of reasons, the Quadeck did not gain wide acceptance and seemed to be overshadowed by the novelty and versatility of the double-tee.

Later, however, a similar member was developed and applied to a pier in New York.

Closing Remarks

Denver has been called the concrete capital of the United States. Today, it leads the nation in the number of prestressed projects per capita.

Credit must be given to everyone involved in the industry, from the manufacturers to the architects to the city building officials.

These men were open-minded and they sought to prove the material could work by investigating the capabilities and the restrictions of prestressed precast concrete (Fig. 28). Their lack of knowledge was not restrictive.

* * *



Fig. 28. Jean Muller (left) and Jack Perlmutter work together on the post-tensioning of a beam to be used with pretensioned channel slabs for Denver Livestock Feed.

In 1951, it took guts and imagination to enter the prestressing industry. Today, it takes about \$2 million.

Colorado is one of the largest volume producers of prestressed concrete in North America. Three major plants are operational in the state including Stanley Structures, Denver (originally Prestressed Concrete of Colorado); Rocky Mountain Prestress, Englewood; and Stresscon, Corp., Colorado Springs.

Stresscon was formed by Don Logan, formerly general manager of Southern Colorado Prestress, one of the early prestressing plants which eventually became part of Prestressed Concrete of Colorado. All three are active participants in the Prestressed Concrete In-

stitute on a national level, and are responsible for the formation of the Colorado Prestressers Association, one of the most active and respected state industry associations in the nation.

Though great strides have been made since prestressing began in this state 27 years ago, I believe the industry has potential which has not yet been realized. But its continued development depends on an attitude which must prevail, an attitude of ingenuity and imagination which was so prevalent during the early days of the prestressed concrete industry in Colorado.

We need to keep questioning, to take the seemingly impossible and prove it workable!

* * *



Part 7—
An Adventure in
Prestressed Concrete

by
Arthur R. Anderson

An Adventure in Prestressed Concrete



Arthur R. Anderson
Concrete Technology Corporation
Tacoma, Washington

*They copied all they could follow
but they could not copy my mind
so I left them sweating and swearing
a year and a half behind.*

Rudyard Kipling

I became acquainted with concrete construction as a child because my father was a contractor. His desire was that my brother Thomas and I follow his footsteps and carve out a career in construction. In fact, my father's ultimate goal was to have his two sons become "Anderson Brothers, General Contractors."

Our training started at an early age, in Tacoma, Washington, shortly after World War I. It was a time when low-slump concrete was hand-mixed and compacted by "rodding" with long slender wooden sticks. When not in school, my brother and I were kept busy much of the time on construction sites.

Our first mixer, a one-wheel-barrow capacity, single-cylinder gas

engine-powered device purchased in the early twenties, was a major advance from hand-mixing, and greatly increased our productivity. A batch consisted of 1 scoop of cement, 3 of sand and 5 of gravel, mixed with about a gallon of water. No slump or cylinders test were required, and the compressive strength of the concrete was probably around 2000 psi (13.8 MPa). Foundation walls and footings 6 in. (152 mm) thick, were plain concrete—no longer permitted by today's codes.

In 1927, we moved up to a steam-powered mixer of 1 cu yd (0.76 m³) capacity. Its boiler was fueled with scrap lumber. As a mixer operator, I also had to stoke the

The author recounts his early involvement in prestressed concrete. In particular, he describes the instrumentation and testing of the prototype Walnut Lane and Pottstown prestressed girders and the highlights of his fact-finding tour of Europe. In the next issue the author will tell how he established a successful business venture in precast prestressed concrete.

boiler—not a comfortable job on hot summer days.

By the time I graduated from high school in 1928, I was a qualified concrete worker. Projects grew in size, and ready-mixed concrete appeared on the scene.

Suddenly, the crash came in 1929, causing an abrupt halt in construction. To better my prospects, I enrolled in the College of Engineering at the University of Washington in Seattle, majoring in civil-structural engineering. In retrospect, my career in engineering can be credited to the "Great Depression."

After obtaining my bachelor's degree, I was fortunate enough to do graduate work at Massachusetts Institute of Technology in Cambridge; and to be inspired by Professor Roy W. Carlson, one of the world's top experts in concrete. My first research project, entitled "A Study in Subaqueous Concrete," was carried out under Dr. Carlson's tutelage, and published in the January 1937 *ACI Journal*.¹

After obtaining my doctorate from MIT, I spent a year (1938-39) in Germany working for Bauer & Scharte & Max Klone as a design engineer. Although I was involved mainly in designing welded steel bridges, the training and experience I received were useful later in my career.

As the dark clouds of World War II gathered, I was fortunate to return to MIT. For the next 2 years (1939-41) I worked on the development of bonded wire electric strain gages as a research associate in collaboration with Professors A. V. DeForest and A. C. Ruge. At the time, I little realized that the laboratory experiences I gained in instrumentation, testing and stress analysis of concrete would prove to be invaluable 10 years later in field testing the prototype Walnut Lane Bridge girder.

From 1941 to 1945 I became involved in the construction of welded steel naval vessels—quite a departure from concrete but useful background when 30 years later ABAM

The Author

Dr. Arthur R. Anderson, a native of Tacoma, Washington, has been involved with prestressed concrete since he was called in as a consulting engineer to instrument and test the prototype Walnut Lane and Pottstown girders. In 1951 he co-founded Concrete Technology Corporation and a year later ABAM Engineers, Inc. There he built one of the earliest precasting plants in the nation.

Dr. Anderson graduated from the University of Washington with a BS in Civil Engineering in 1934. He then went to the Massachusetts Institute of Technology, where he earned an MS in 1935, and an ScD in 1938.

President of PCI in 1970-1971, Dr. Anderson has also received PCI's Medal of Honor for his many services and contributions to the Institute and industry. He has won numerous other awards, including the FIP Medal and the T. Y. Lin Award. In 1976 he was elected to the National Academy of Engineering. He is the author of several technical papers, some of which have appeared in the PCI JOURNAL.

Throughout his career, Dr. Anderson has been known for his innovative designs and daring technological advances. A major breakthrough came in 1956 when his firm designed and built Boeing Company's Developmental Center and a year later the 21-story Norton Building. Later he participated in the design and construction of the Disneyworld monorail system and the prestressed concrete ARCO LPG vessel constructed in Tacoma and towed to Indonesia. Currently, he is still active in his firm developing new design concepts and research needs for advanced structures.

and Concrete Technology designed and built the giant ARCO pre-stressed LPG vessel.

In 1946, I opened my own consulting office in Springdale, Connecticut. At the time, wire resistance strain gages (such as the Baldwin SR-4 type) were being used increasingly to determine strains, and thereby the stress distribution, in machines and structures.

I had long felt there was a need for a rapid, simple, yet reliable means to find the stress intensity at several locations in a loaded structural member. Subsequently, I developed a strainmeter (Anderson Model 301 Strainmeter) which could accurately and rapidly measure static strains at a number of gage locations.² This instrument could accommodate 24 strain gages, thus eliminating the necessity for disconnecting and reconnecting gage wires for each gage reading.

Later, I also developed a bridge balancer (Anderson 302 Bridge Balancer) which, while combining the features of the earlier strainmeter, could measure strains under combinations of static and dynamic loads.

The availability of these instruments plus the testing techniques I developed in the field proved very useful when it came time to test the Walnut Lane Bridge prototype girder.

Walnut Lane Bridge

My introduction to the Walnut Lane Bridge was through my good friend, A. G. Formel (Construction Manager of the Preload Corporation). He called me one day in 1949 to tell me about the project and the City of Philadelphia's plans to

test to destruction a 160-ft (49 m) prototype girder of the bridge. Being aware of my training and experiences in field testing and instrumentation, Formel encouraged me to apply for the testing job—which I did.

I was interviewed by Thomas Buckley, Director, Department of Public Works of the City of Philadelphia, and other key members of his staff. Today, I still vividly remember the interview which was as intense and thorough as the oral examination for the Doctoral degree at MIT.

The person responsible for testing the prototype girder was required to be at the job site continuously during the entire fabrication and stressing operations. He had to be there at all times to record the strains and measure the deflections of the girder as it was incrementally loaded.

My instrumentation plan and testing procedure were submitted to the City of Philadelphia, Department of Engineering and Surveying. The proposal was reviewed by Samuel Baxter, Assistant Chief Engineer, and his staff, then forwarded to Professor Gustave Magnel (Fig. 1), the designer of the Walnut Lane Bridge and the world's foremost expert on prestressed concrete testing, design and construction, at the University of Ghent in Belgium, for his approval.

The City of Philadelphia was careful to point out that Professor Magnel's seal of approval was imperative if fabrication and testing of the girder were to proceed. To our delight, Professor Magnel liked my instrumentation plan and testing procedure.

Details of the design, testing and construction of the Walnut Lane Bridge have been well publicized in References 3 through 10. In addition, Zollman recently¹¹ gave an excellent overview of the events surrounding the Walnut Lane Bridge. Therefore, in this article I will only summarize the highlights involved in instrumenting and testing the experimental girder.

The test girder, nearly 160 ft (49 m)



Fig. 1. Professor Gustave Magnel had overall charge for the testing of the experimental Walnut Lane prototype girder.



Fig. 2. Clement Atchit, resident engineer from Bleton-Aubert, Brussels. His know-how and friendly advice was a major factor in the successful production of the Walnut Lane test girder. In the background can be seen the prototype girder and steel ingots.

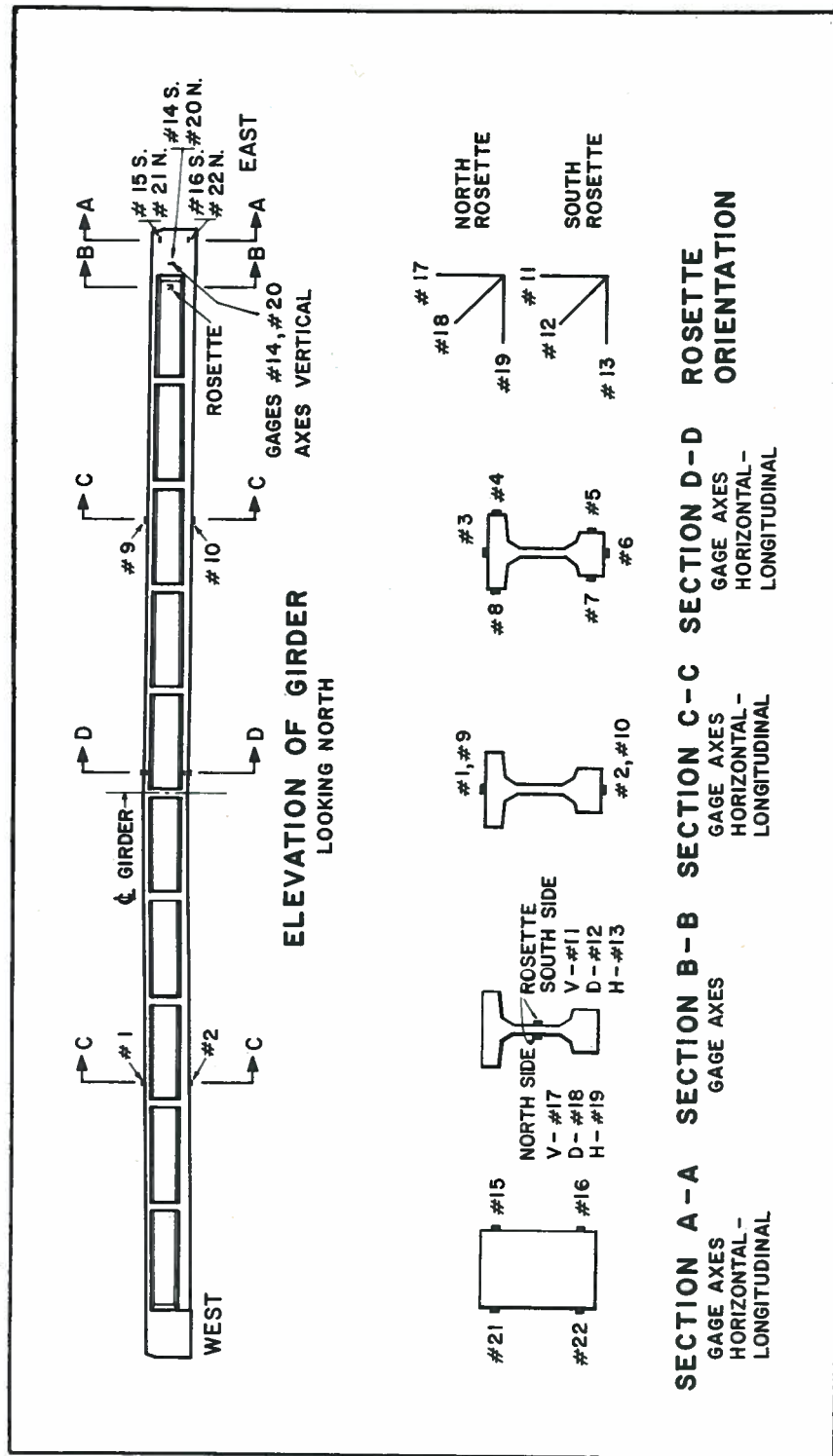

Fig. 3. Elevation of Walnut Lane test girder showing location of electric strain gages.

long, 4 ft 4 in. (1.3 m) wide at the top and 6 ft 7 in. (2 m) deep, was a modified I-beam, weighing about 160 tons (145 t). The girder was cast at the job site using ready-mixed concrete containing 800 lbs of cement per cu yd (1424 kg/m³). Much of the success for the fabrication of the concrete test girder was due to Clement Atchit (Fig. 2), resident engineer from Blaton Aubert, Brussels, Belgium.

Prior to post-tensioning, 22 SR-4 strain gages were applied to the surface of the concrete. Fig. 3 shows the location of these gages.

I was responsible for the instrumentation (Fig. 4), strain readings and deflection measurements.

The gage locations were rubbed to a smooth plane surface, wire brushed, and a film of 0.010-in. (0.25 mm) thick celluloid was applied to the prepared surface with a generous coating of household Duco cement.

This coating was allowed to dry for 2 days and then the film was sandpapered smooth. The SR-4 gages were then applied to the celluloid film with Duco cement and allowed to dry for 2 days. Fig. 5 shows the gage as applied over the celluloid film to the concrete.

After the gages were thoroughly dried, a coat of waterproof Petrosene wax was applied and the concrete around the gage area was coated with lacquer to provide a moisture barrier. Wiring from the strain gages was run to a small instrument shelter in which two Anderson Model 301 strainmeters were located (see Fig. 6).

Sixteen days after the concrete was cast, post-tensioning of the girder by the Blaton-Magnel system commenced, and this operation was completed in 5 days. The prestressing caused the center of the girder to deflect 1 1/4 in. (32 mm) upward from the temporary cribbing.

Strain readings during the prestressing operation were recorded. Young's modulus of elasticity of the concrete, E_c , was established from stress-



Fig. 4. The author examining the instrumentation during the testing of the Walnut Lane prototype girder.

strain data taken on test cylinders at 17 and 21 days.

Using a value of $E_c = 3,500,000$ psi (24,130 MPa) for the concrete at the time of prestressing, the stress at the girder center from strain data was compared to calculated values for the post-tensioned condition:

Girder location	Strain data	Computed values
Top fibers (comp.)	1050 psi (7.24 MPa)	1120 psi (7.72 MPa)
Bottom fibers (comp.)	1990 psi (13.72 MPa)	1885 psi (13.00 MPa)

Load tests were made using eight hydraulic jacks spaced at 20-ft 8-in. (6.3 m) intervals along the girder. Steel frames ballasted to the ground by ingots pro-

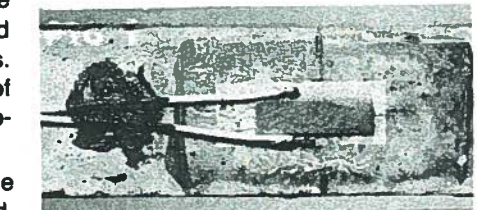

Fig. 5. Strain gage applied over celluloid film to concrete.



Fig. 6. Two Model 301 strainmeters used with the electric strain gages. Compensator gage is located on the test cylinder below.

vided the reaction for the jacks shown in Figs. 7 and 8.

To obtain accurate load increments, steel bars with SR-4 gages attached were located over each jack (Fig. 9) as the hydraulic pressure gages in the jacks were known to be inadequate for the small load increments up to the working load. Because of the large deflections in the girder at the higher loads, stability of the load frames became critical, and the strain gage bars had to be removed from the jacks after the cracking load of 1400 lbs/ft (2100 kg/m) was reached.



Fig. 7. Looking east, showing loading arrangement on Walnut Lane test girder. Steel ingots are in foreground.

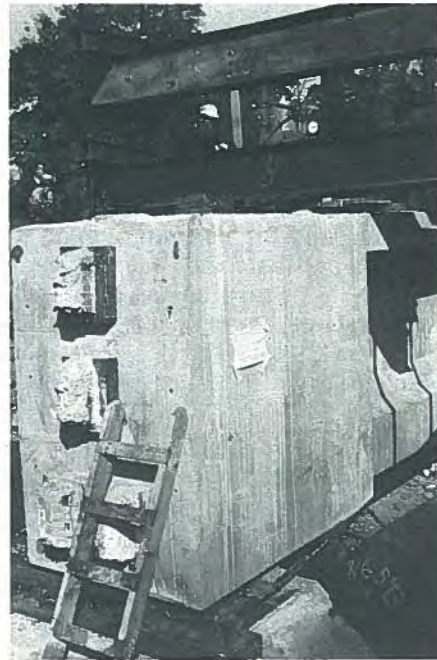
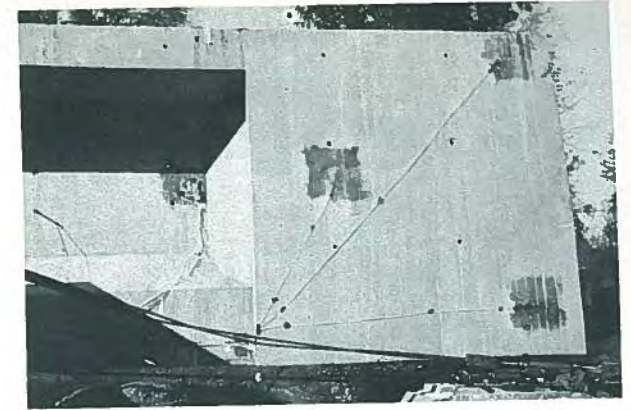

Fig. 8. West end of Walnut Lane test girder, showing clinometer. Strain gage load cell is located over jack.

Fig. 9. East end of Walnut Lane test girder, looking north, showing strain gage installation on concrete.



The so-called cracking load for this test girder requires a word of explanation. A settlement crack had formed in the girder before prestressing, which closed completely after the stressing of the wires. A strain gage was applied across the crack and at the above-mentioned load it indicated a sudden abnor-

mal increase, showing that the crack was reopening.

Thus, at the 1400 lb/ft (2100 kg/m) loading of the girder, the compression of the bottom fibers at midspan was exhausted and further loading transformed the section from a prestressed to a conventional reinforced concrete gir-

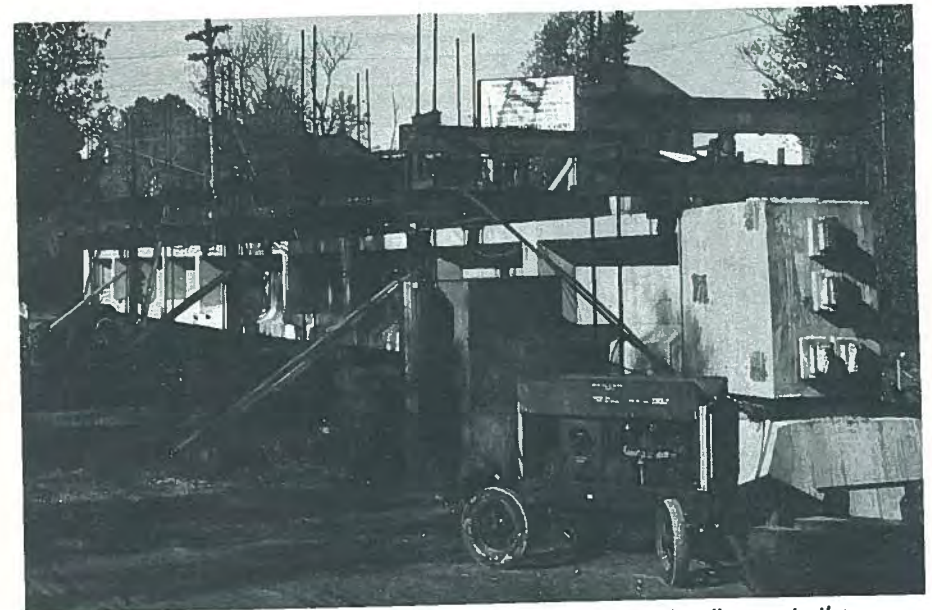

Fig. 10. Looking northwest at Walnut Lane test girder, after loading up to the capacity of the jacks. Instrument shelter can be seen in the foreground.



Fig. 11. General view immediately after destruction of Walnut Lane test girder. Failure occurred at 3:00 p.m., October 27, 1949.



Fig. 12. Closeup of fracture zone of Walnut Lane test girder. Failure was in the top flange to right of the stiffener.

der. (Had no crack existed in the girder before prestressing, the cracking load would have been the load at which the concrete ruptured in tension.)

The moment of inertia of the midspan section at this juncture dropped from 1,250,000 to 272,000 in.⁴ (0.052 to 0.113 m⁴) Load indications at the higher values were obtained from the Bourdon-type pressure gages on the jacks, and they were not sufficiently reliable for analysis purposes.

Fig. 10 shows a general view of the test girder when loaded to the capacity of the jacks. The midspan deflection was 15 in. (381 mm). The final loading to destruction was carried out by placing an additional 59 tons (53.5 t) of ingots on the girder at midspan. Figs. 11 and 12 show a general view and closeup of the failure.

To correctly evaluate the load test strain readings (and hence the stress distribution in the concrete girder), an accurate determination had to be made

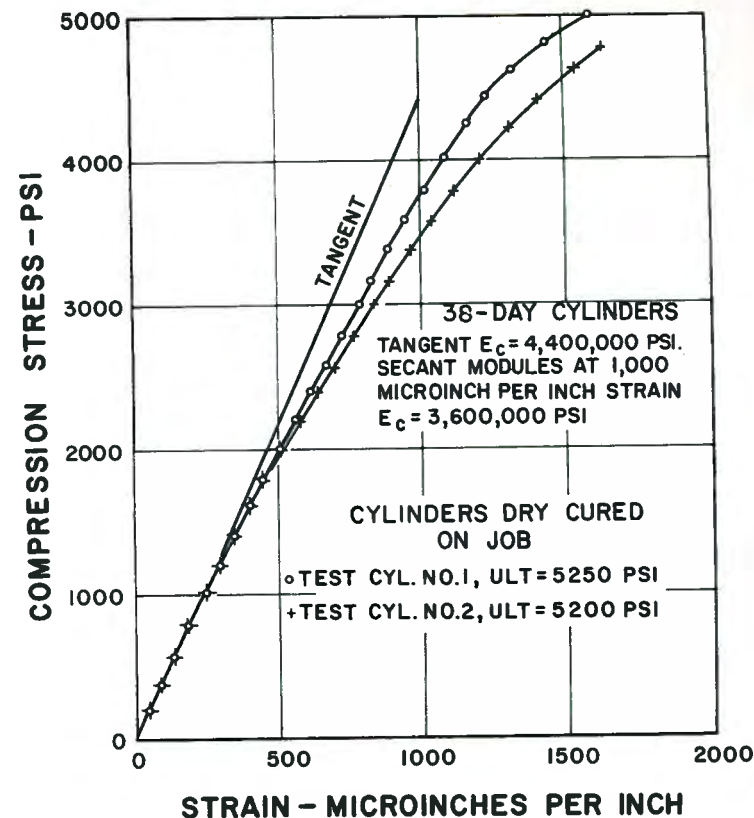

Fig. 13. Stress-strain curves for two Walnut Lane job-cured 38-day test cylinders, obtained with SR-4 strain gages.

of the modulus of elasticity of the concrete. It soon became apparent that the value of the modulus of elasticity fluctuated greatly depending on the age of the concrete and the method used to determine its value.

To gain some reliability, three independent methods were used to determine the modulus of elasticity of the concrete:

(a) Compression tests on two 38-day job-cured cylinders were made with a pair of SR-4 strain gages located on opposite sides of each cylinder to give average stress-strain curves (see Fig. 13). From the cylinder stress-strain data given in Fig. 13, the value for E_c was

found to be 4,600,000 psi (31,720 MPa).

(b) The fundamental frequency of the girder was measured when excited into vibration by men jumping on it. Fig. 14 (top) shows oscillograms obtained with a brush recorder connected to strain

test. The average frequency recorded was 2.16 cycles per sec. Using a simple calculation method (see Fig. 14), E_c was found to be 6,550,000 psi (45,160 MPa).

(c) Calculations were also made from the slope and deflection measurements obtained from the load tests. From these computations E_c was found to be 6,000,000 psi (41,370 MPa).

Values for the modulus of elasticity

**Oscillograms of
Girder Vibration
(Chart speed: 5 mm/sec.)**

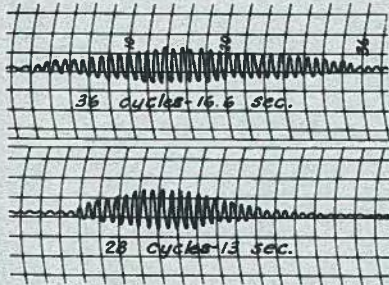

**Computation Steps in
Determining Modulus of
Elasticity of Concrete**

f_n = cycles/sec
 Test No. 1, 36/16.6 = 2.17
 Test No. 2, 28/13 = 2.15
 Average f_n = 2.16 cycles/sec.
 Girder weight: 1730 lb/ft
 or W = 144 lb/in.
 u = mass/in. = W/g
 = 144/386 = 0.374

$$\text{From } f_n = \frac{\pi}{2} \sqrt{\frac{EI}{ul^4}}$$

$$\sqrt{\frac{EI}{ul^4}} = \frac{2.16}{1.57} = 1.375$$

$$\sqrt{\frac{(E)(1.273)(10^6)}{(0.374)(1856)^4}}$$

$$= \sqrt{\frac{E}{3.47 \times 10^6}} = 1.375$$

from which
 $E = (1.375)^2 (3.47) (10^6)$
 = 6,550,000 psi

Fig. 14. Two sample oscillograms and calculation method for evaluating modulus of elasticity of concrete (Walnut Lane test girder).

determined by stress-strain data were considered too low whereas a value averaging those obtained by the frequency and slope and deflection measurements [Methods (b) and (c)] was considered more representative.

In general, the data obtained from the Walnut Lane girder tests were considered valuable in verifying the design of the bridge. Strain, slope, and deflection measurements obtained were in good agreement with theoretical values.

The experience gained from the test indicated the importance of good load indicating methods, and a need for obtaining accurate stress-strain curves up to ultimate loads. It also pointed up the difficulties in obtaining a representative value for the modulus of elasticity of the concrete and in estimating creep and shrinkage in the concrete and relaxation in the prestressing steel.

The performance of the prototype girder under all loading stages, up to and including ultimate, exceeded all expectations. Although Professor Magnel correctly predicted the behavior of the girder he confided to us that had he known Americans were capable of producing such good concrete and prestressing steel he would not have been quite so conservative in the design of the girder! (It must be appreciated, of course, the Belgian professor was skeptical regarding American quality control and production methods.)

The entire concept that a major structure could be designed and built using prestressed concrete stirred the imagination of the bridge building fraternity in the United States. The test to destruction of an experimental girder was the proof of the pudding that such a concept could be attained realistically.

The successful instrumentation and testing of a full-sized prestressed girder is historically significant because it instilled public confidence in prestressed concrete and marked the beginning of sophisticated instrumentation and testing procedures for the product.

Pottstown Test Girder

In the spring of 1950 (a few months after the Walnut Lane experimental girder was tested), I was called upon to load test to destruction a full-scale 30-ft (9.15 m) prestressed bridge girder for Concrete Products Corporation of America in Pottstown, Pennsylvania.¹²

The Pottstown test was significant in two ways: (1) the girder was cast and pretensioned at the plant and (2) for the first time seven-wire strand was used to prestress the girder.

Fig. 15 shows a plan, side view and enlarged sections of the girder together with the location of the strain gages.

The 30-ft (9.15 m) test girder was manufactured using the Hoyer method

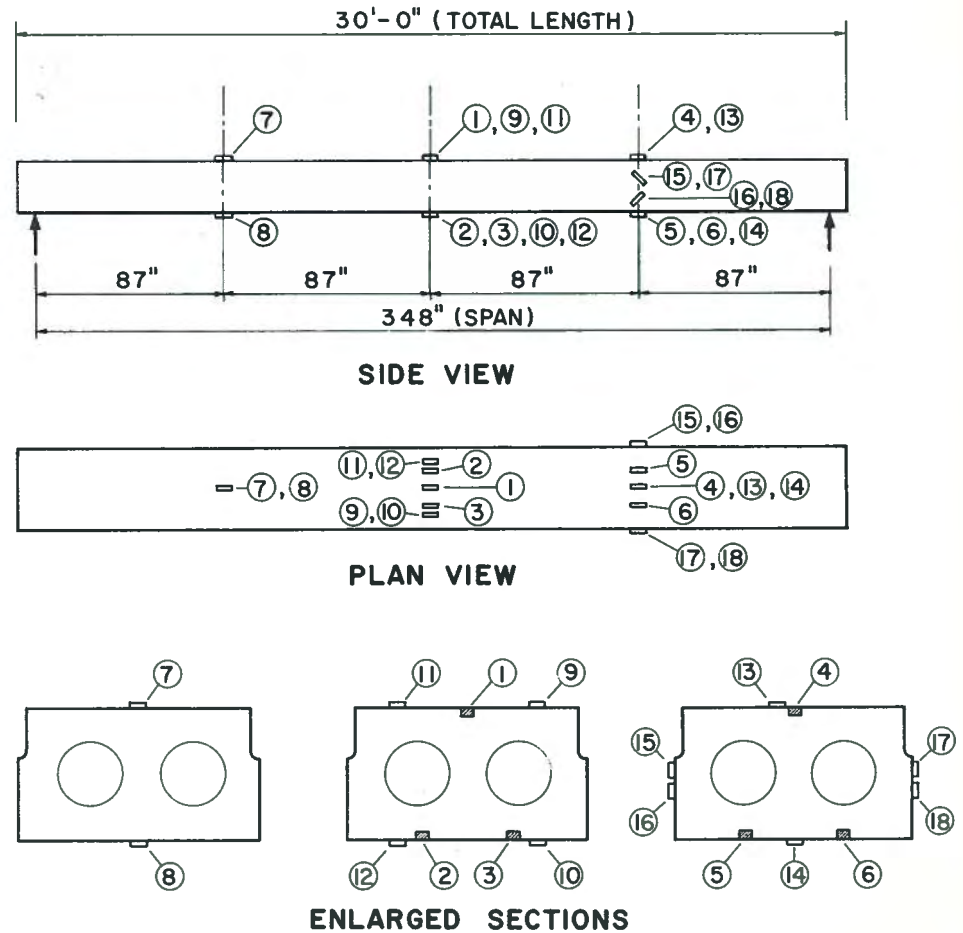

NOTE: GAGES ① THROUGH ⑥, SPECIAL INTERNAL GAGES CAST IN CONCRETE.
 GAGES ⑦ THROUGH ⑱ ATTACHED TO SURFACE.

Fig. 15. Plan, side view and sections of Pottstown test girder showing location of strain gages.

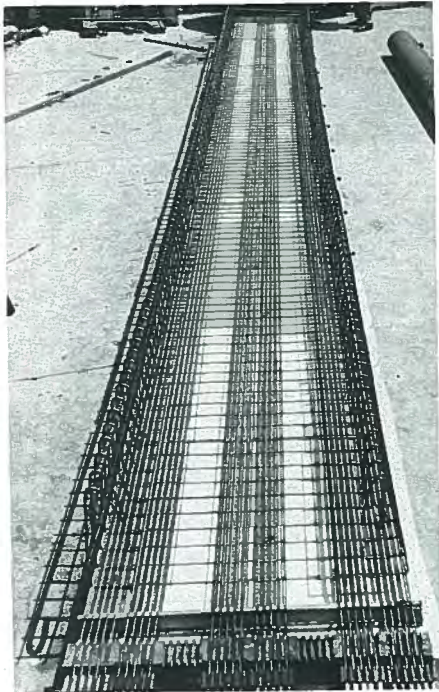

Fig. 16. End view of Pottstown girder showing details of reinforcement.

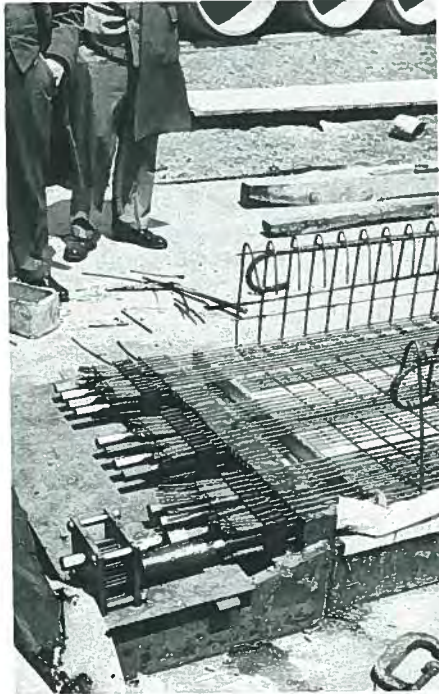

Fig. 17. Details of jack and anchorage of pretensioned wire.

of pretensioning the wires before casting the concrete. Fig. 16 shows the details of the reinforcement and Fig. 17 is a closeup of the jack and anchorage of the pretensioned wire.

In order to measure the compression prestress in the bottom fibers of the girder from the tension force of the wires, it was necessary to embed special strain gage units in the concrete. These units were made by attaching SR-4 gages to curved metallic members (see Fig. 18).

After calibration, the units were embedded in blocks of concrete mortar, which provided protection against moisture and rough treatment when placing concrete around them. The circuit used with these gages provided temperature compensation within the unit—a considerable advantage for field test projects subjected to extremes in weather.

Fig. 19 shows the gage units in the

form, ready to be embedded in concrete. In Fig. 20 the girder is about half cast, showing the paper tubes used to form voids in the concrete.

After obtaining the strain readings due to release of the ends of the pretensioned wires, the girder was set up for



Fig. 18. Special strain gage units, each containing four SR-4 gages encased in small blocks of concrete mortar after calibration.

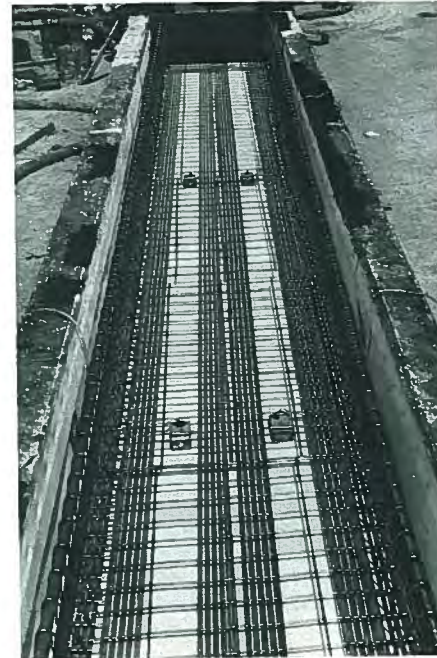

Fig. 19. Form ready for concrete, showing internal strain gages on bottom of beam.



Fig. 20. Girder is about half cast, showing paper tubes used to form voids in the concrete.

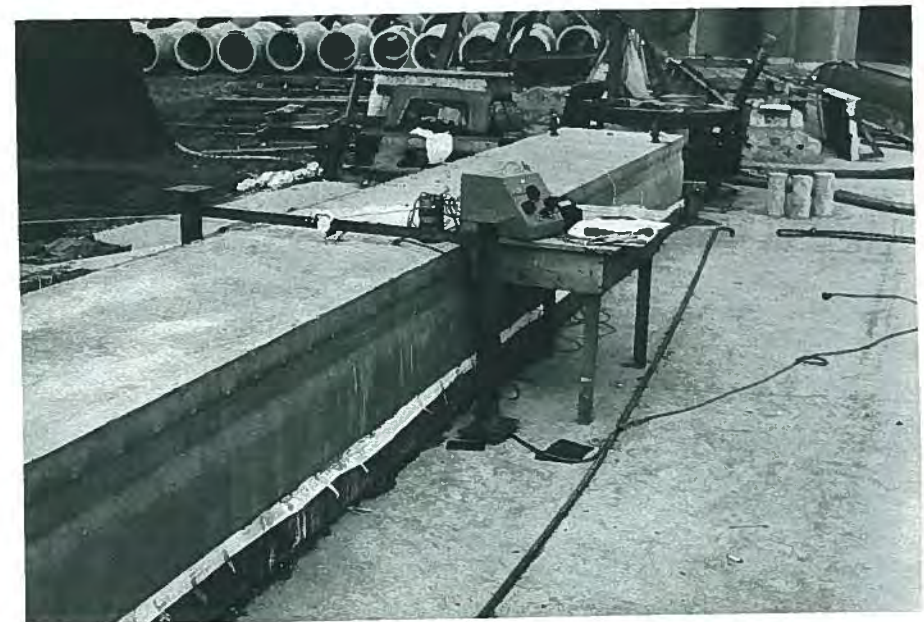

Fig. 21. Strainmeter setup for measuring strains during prestressing operation.

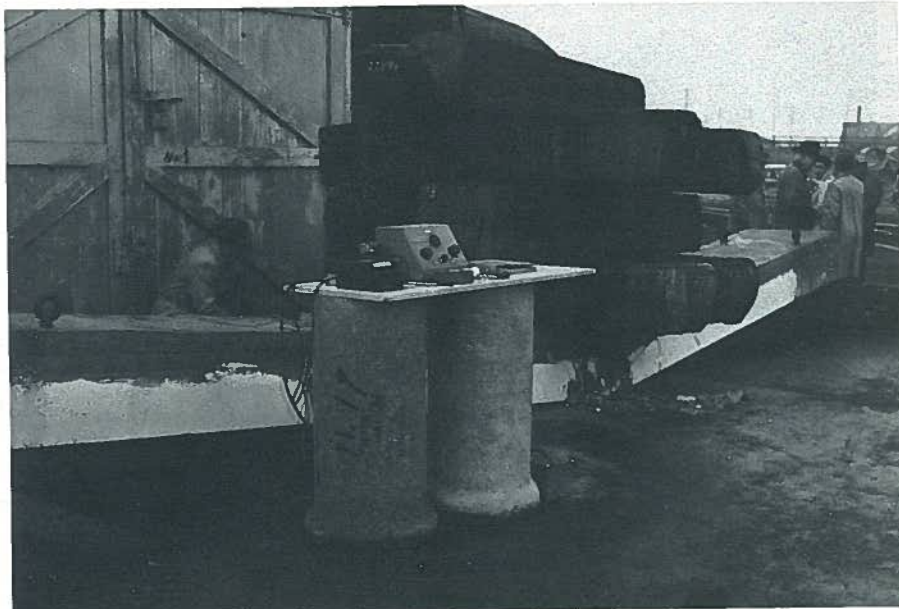

Fig. 22. After destruction test, 74,990 lbs (334,000 N) of ingots were placed on center of beam. Note that strainmeter is in foreground. (Pottstown prototype girder.)

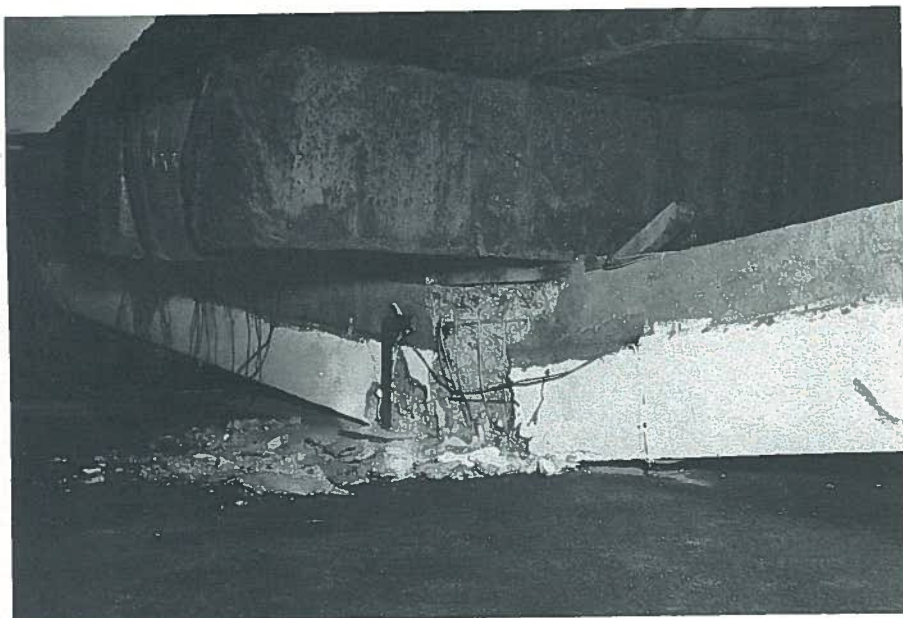

Fig. 23. Closeup of fracture. Note wires leading to strain gages on beam. (Pottstown prototype girder.)

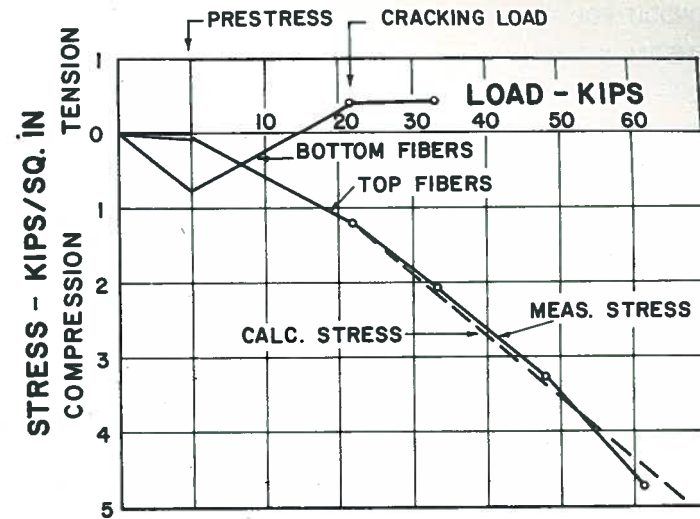

Fig. 24. Comparison of calculated and measured stresses of 30-ft (9.15 m) long pretensioned girder at Pottstown.

load tests. Additional SR-4 gages were installed at several locations on the concrete surface, using a similar procedure as was done for the Walnut Lane strain gages. Fig. 21 shows the strainmeter setup for measuring strains during the pretensioning operation.

The load tests were accomplished by loading steel ingots directly on the girder. Since each ingot had been accurately weighed beforehand, the weight being marked on the ingot, it was simple to record the loads. Figs. 22 and 23 show the girder and test setup after loading to destruction.

As had been done for the Walnut Lane tests, the modulus of elasticity of the concrete was obtained by three different methods:

(a) Test cylinders with SR-4 gages attached to opposite sides of each cylinder to give average strain during compression loading. From these results the modulus of elasticity of the concrete E_c was determined to be 3,180,000 psi (21,930 MPa).

(b) Frequency measurement of the

girder vibrating in its fundamental mode. The value for E_c was found to be 3,080,000 psi (21,240 MPa).

(c) Deflection of the beam. The value for E_c obtained was 3,240,000 psi (22,340 MPa).

Measured and calculated strains for the top and bottom fibers of the test girder are plotted in Fig. 24.

Further Developments in Instrumentation

The Walnut Lane and Pottstown prototype girder tests were significant milestones not only in the public acceptance of prestressed concrete but also in paving the way for improved instrumentation techniques both in the field and laboratory.

As mentioned earlier, a better method needed to be found to determine the creep and shrinkage of concrete, and steel relaxation (and hence the prestress losses) in a prestressed member over a period of time. One major problem was

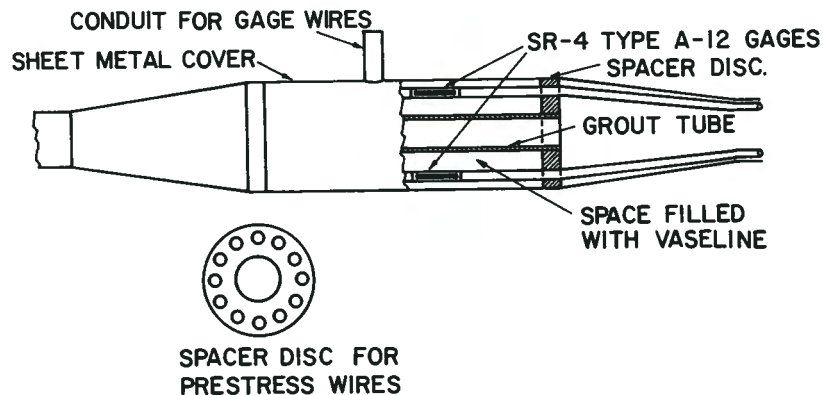

Fig. 25. Device for installing SR-4 strain gages on the wires of a Freyssinet cable.

to find a reliable means to measure the loss of tension in prestressing steel with time. Most prestressing systems did not allow ready access to the wires inside the concrete. In particular, the Freyssinet system of encasing the tendon in a metal sheath before concreting was an example of the inaccessibility of the wire for strain measurements.

An ingenious scheme was devised by Frank Hines to overcome this drawback (see Fig. 25).¹³ The prestressing wires are separated for a short distance by two discs rigidly supported by a piece of pipe. The pipe also provides a passage for the grout through the cable without disturbing the strain gages.

A somewhat simpler scheme¹⁴ for measuring wire tension utilizes the measurement of lateral deflection of the wire for a given transverse load. A simple device (see Fig. 26), consists of a stiff bar with clamps at the ends attached to the wire.

At the center of the bar, a micrometer head is arranged to deflect the wire transversely. The load required for a given deflection is indicated by strain gages attached to the bar to indicate the bending moment at the center of the bar.

The load-deflection relationship for the wire is given in Fig. 26.

Application of this device was found to

be particularly useful in determining the loss in steel tension in a pretensioned beam due to creep, shrinkage and steel relaxation (see Figs. 27 and 28).

* * *

Meanwhile, my brother Thomas, after acquiring degrees from the University of Washington and Massachusetts Institute of Technology, had pursued a career in civil engineering and general construction. He was engaged in various general contracting in Washington State from 1938 to 1941, then served in the United States Navy, with the Sea Bees, during World War II.

At the time of the Walnut Lane Bridge project, in 1948, Tom had resumed his contracting business in Tacoma, Washington. However, my father, Eivind Anderson still hoped to unite his sons in a family construction firm. The growing interest in the new (to America) techniques of prestressing concrete, in the wake of the Walnut Lane Bridge and other early projects, made prestressed concrete construction a logical choice for this proposed family enterprise. We had all accumulated much experience with concrete, and I had already become involved with the developing prestressing industry in America.

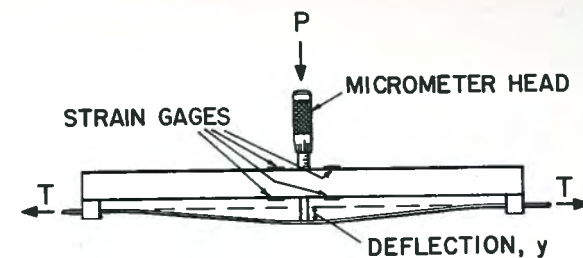

The load-deflection relationship for the wire is:

$$y = \frac{Pj}{2T} \left[\frac{1}{2} U - \tanh \frac{1}{2} U - \frac{(1 - \text{Cosh } \frac{1}{2} U)^2}{\text{Sinh } \frac{1}{2} U \text{Cosh } \frac{1}{2} U} \right]$$

where

y = deflection

P = transverse load producing the deflection

$$j = \sqrt{\frac{EI}{T}}$$

E = Young's Modulus of wire

I = moment of inertia of wire section

T = tension in wire

L = length of the wire

$$U = \frac{L}{j} \text{ radians}$$

Fig. 26. Transverse load-deflection device for measuring tension in a prestressing wire.

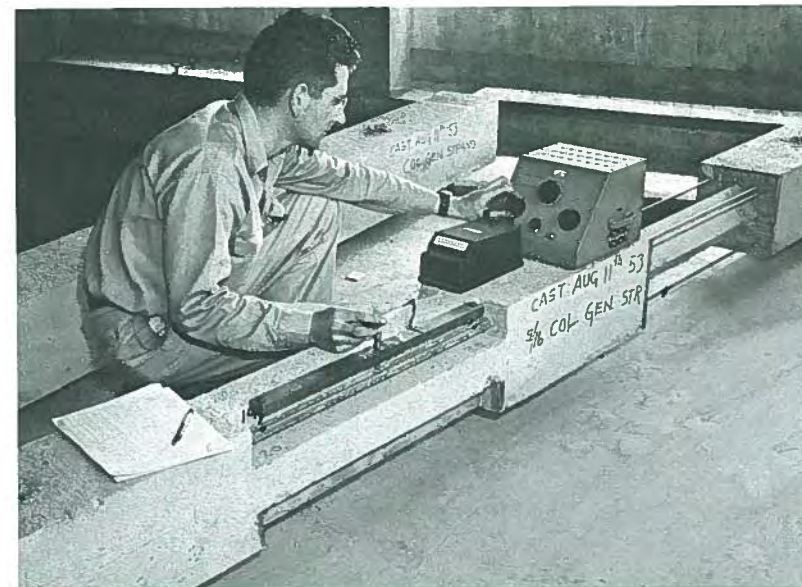

Fig. 27. Application of wire tensometer to determine bond transmission and prestress losses.

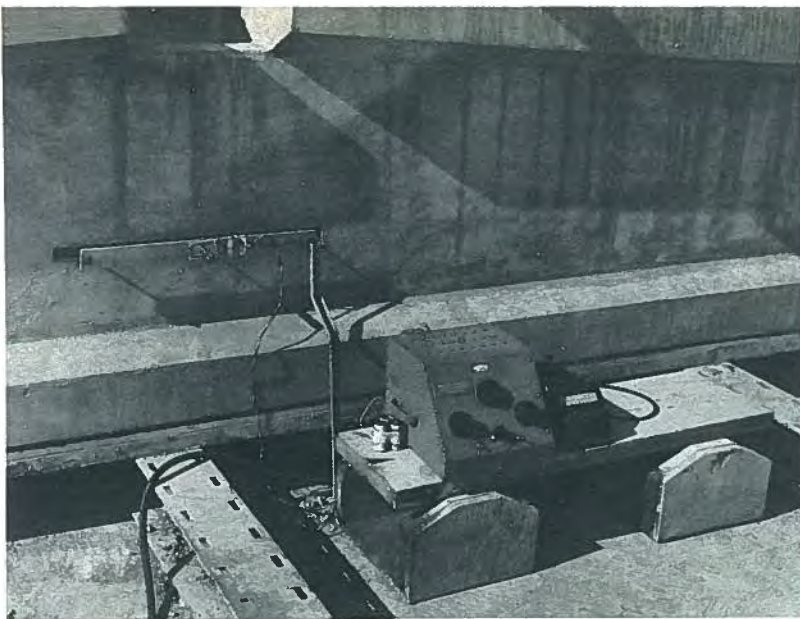

Fig. 28. Application of wire tensometer in full-scale roof girder.

European Tour

Before setting up the new venture, all three Andersons agreed it would be prudent to visit the European centers of prestressed concrete development. This would give us a better idea of what had already been done with prestressed concrete in Europe and what new developments and research were in progress. This background information would be

essential if we were to assess accurately the potential of prestressed concrete in the United States, and to make our projected company a success.

The 2½-week trip, in early October 1950, covered France, Switzerland, Belgium, Sweden, and England.¹⁵ There we visited precast prestressing plants, construction sites, and research laboratories and had the opportunity to meet and converse with the leading experts in prestressed concrete engineering, design and construction.

Fig. 29. Prestressing yard for segments of covered viaduct, in Rouen, France.



In France, the leading company in prestressed concrete engineering was the Société Technique pour l'Utilization de la Précontrainte (STUP), the engineering firm created by the French prestressing pioneer, Eugene Freyssinet. STUP held the patents for the Freyssinet prestressing system, then used extensively in France and other parts of the world.

France had many, and varied, examples of prestressed concrete construction, including bridges, hangars, aircraft landing fields, dams, tunnels, piers, revetments, railroad ties, water conduits, caissons, and silos. The Director of STUP, M. Burgeat, kindly arranged for us to visit two of their current projects. Both of these used precast prestressed units, post-tensioned together.

The first of the two STUP projects we visited was a 5850-ft (1783 m) covered viaduct under construction in Rouen (Fig. 29). The precast prestressed units were post-tensioned together, forming spans varying from 26 to 58 ft (7.9 to 17.7 m) in length. When complete, the viaduct would carry two railroad tracks within the box and a super-highway on the upper deck (Fig. 30).

The structure in Orleans was a water reservoir built to include operating and office space in the lower levels, and water storage above. Achieving this de-



Fig. 30. Covered viaduct under construction, Rouen, France.

sign would have been very difficult, and probably impractical, without using prestressed concrete (Fig. 31).

In Switzerland we were impressed by the prefabricated prestressed flooring known as "Stahlton planks" produced by Stahlton A.G., headquartered in Zurich. We visited their plant at Frick, where the clay tile sections that composed the plank were made, and stressed together. These prefabricated floor components made possible savings of weight, materials, and cost when erecting building floor systems.

We also saw some projects using the BBRV button-headed wire post-tensioning anchorage system.

In Belgium, we visited Professor Magne's laboratory at the University of Ghent, and the engineering firm Bla-

Fig. 31. Water storage reservoir and offices, Orleans, France.



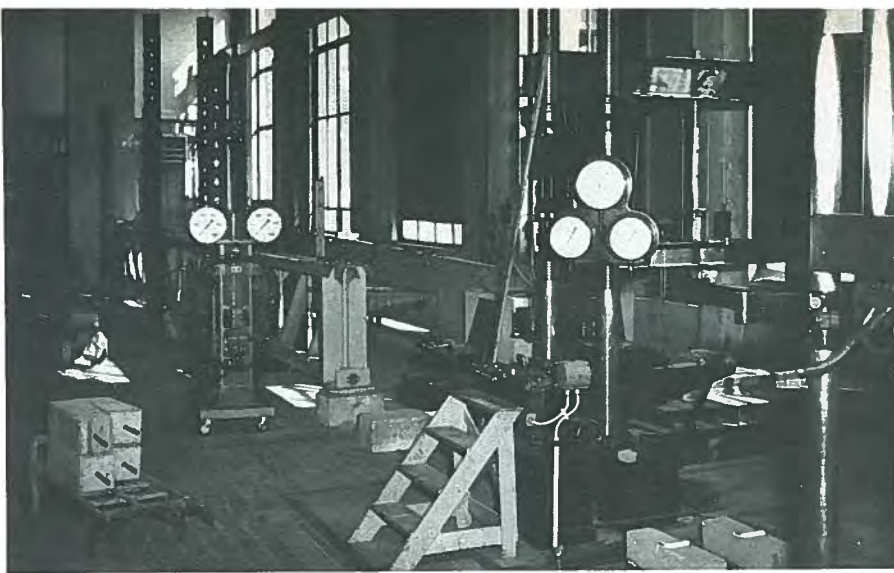

Fig. 32. Professor Magnel's prestressed concrete research laboratory at the University of Ghent in Belgium.

ton-Aubert. Professor Magnel and M. Blaton had been the prime consultants for the Walnut Lane Bridge and we were eager to see what else they had done.

Professor Magnel was at this time acknowledged as the world's foremost authority (together with Freyssinet) on prestressed concrete. His laboratory was magnificent and the most advanced research center in the world. Indeed, engineers from all over Europe and, increasingly, America, were coming to learn from him (Fig. 32). Professor Magnel was very helpful and generous in sharing his knowledge with us.

Blaton-Aubert was working on several projects which used the Magnel "sand-

wich plate" post-tensioning anchorage system. We were able to visit some of these, including a warehouse under construction in Ghent (Fig. 33 and 34).

This project, similar to others we saw, used precast segments which were cast on site. Thus far, we had been impressed by the economy of the material, but concerned by the necessary on-site labor, which would cost much more in the United States. This labor cost could keep cast-in-place prestressed concrete from being fully competitive with other building materials.

Our visit to the A. B. Betongindustrie prestressed concrete (Strängbetong) plant in Stockholm, Sweden, was

Fig. 33. Construction site of prestressed warehouse in Ghent, Belgium. The beams, cast on location, are ready to be hoisted into position.



Fig. 34. Prestressing wires locked in position at end of beam.

perhaps the high point of the entire trip. Using factory mass production techniques, they produced a large variety of consistently high quality precast prestressed standard building elements, including rectangular and I-section straight and saddle beams, piles, and planks (Fig. 35).

Here, then, was the answer to the discouraging amount of site labor necessary at most of the projects we had seen previously—precasting standard segments at a factory rather than individually, on-site. The Swedes were con-

strained by climate, with the impossibility of casting outdoors so much of the year, as well as by the highest labor costs in Europe; we in America by the high cost of labor. The same technique could enable prestressed concrete to be a competitive construction technique for both countries.

In England, we visited a similar precasting plant where prestressed products were being manufactured but on a somewhat limited scale. Nevertheless, the potential and economy of plant-fabricated elements became apparent.

Fig. 35. Interior of A. B. Betongindustrie factory in Stockholm, Sweden, showing some of the precast concrete components.

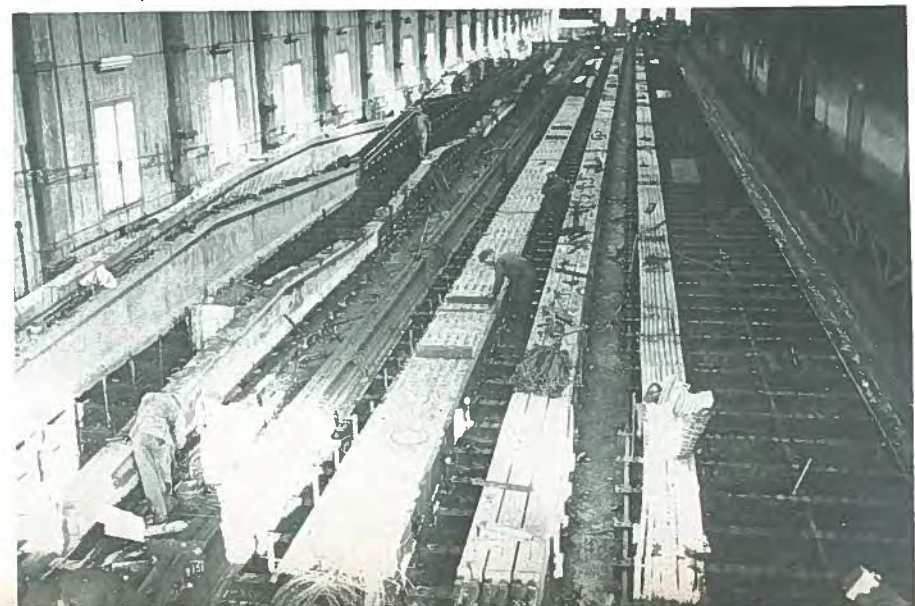

Based on our experiences in Europe (particularly in Sweden and England), we were convinced that prestressed concrete would have to be mass produced under controlled factory conditions to be successful in America. The stage was thus set for me to rejoin my

father and brother back in Tacoma where we would plan our joint venture in precast prestressed concrete.

In the next issue of the JOURNAL I will recount how we established our plant and began our life-long career in prestressed concrete.

References

1. Anderson, Arthur R., "Study of Subaqueous Concrete," *ACI Journal*, V. 33, January-February 1937, pp. 339-346.
2. Anderson, Arthur R., *Strain Measurement Simplified*, Brochure, Springdale, Connecticut, 1949, 4 pp.
3. Schofield, E. R., "First Prestressed Bridge in the U.S.," *Engineering News-Record*, December 30, 1948, 3 pp.
4. Schofield, E. R., "Construction Starts on Prestressed Concrete Bridge in Philadelphia," *Civil Engineering ASCE*, July 1949, pp. 32-34.
5. Bowman, Waldo, "Full-Size Prestressed Girder Tested," *Engineering News-Record*, November 3, 1949.
6. "Testing Long Prestressed Concrete Girder," *Concrete*, V. 57, No. 12, December 1949, pp. 3-6.
7. Anderson, Arthur R., "Prestressed Concrete Girder Test, Walnut Lane Bridge, Philadelphia," Unpublished Report, Springdale, Connecticut, November 11, 1950.
8. Magnel, Gustave, "Prototype Prestressed Beam Justifies Walnut Lane Bridge Design," *ACI Journal*, Proceedings, V. 47, No. 4, December 1950, pp. 301-316.
9. Fornerod, M., "Load and Destruction Test of 160-foot Girder Designed for First Prestressed Bridge in U.S.A.," International Association for Bridge and Structural Engineering, Zurich, Switzerland, 1950.
10. Baxter, S. S., and Barofsky, M., "Construction of the Walnut Lane Bridge," Proceedings, First United States Conference on Prestressed Concrete, Massachusetts Institute of Technology, Cambridge, Massachusetts, August 14-16, 1951, pp. 47-53.
11. Zollman, Charles C., "Reflections on the Beginnings of Prestressed Concrete in America—Part 1: Magnel's Impact on the Advent of Prestressed Concrete," *PCI JOURNAL*, V. 23, No. 3, May-June 1978, pp. 21-48.
12. Anderson, Arthur R., "Strain Measurements and Analysis, Prestressed Concrete Beam for Concrete Products Corporation of America," Unpublished Report, Springdale, Connecticut, July 21, 1950, 20 pp.
13. Anderson, Arthur R., "Field Testing of Prestressed Concrete Structures," Proceedings, First United States Conference on Prestressed Concrete, Massachusetts Institute of Technology, Cambridge, Massachusetts, August 14-16, 1951, pp. 215-220.
14. Anderson, Arthur R., "Wire Tensometer for Prestressed Concrete Research," *Testing Topics*, V. 8, No. 2, Baldwin-Lima-Hamilton Corporation, Philadelphia, Pennsylvania, April-May-June 1953.
15. Anderson, Arthur R., "Prestressed Concrete Enterprises in Europe, and Possible Applications in the United States," Unpublished Report, Springdale, Connecticut, 1950, 14 pp.

* * *

An Adventure in Prestressed Concrete



Arthur R. Anderson
Concrete Technology Corporation
Tacoma, Washington

*We judge ourselves by what we feel
capable of doing, while others judge
us by what we have already done.*

Longfellow

In the last issue of the PCI JOURNAL I described my involvement in the instrumentation and testing of the Walnut Lane and Pottstown prototype girders. I also gave my impressions of our fact-finding tour of European prestressed concrete developments in October 1950.

Based on these experiences plus the wave of enthusiasm this new material was generating, I became convinced that pretensioned concrete, mass-produced under controlled factory conditions, had the potential of playing a prominent role in the North American construction market. My plan, therefore, was to rejoin my father Eivind and brother Thomas in Tacoma, Washington, and there establish a plant for the

manufacture of precast prestressed products.

However, prior to going back to Tacoma, I had to complete an important consulting job for the Austin Company in Cleveland, Ohio.

Austin Company Tests

It is worth recalling that the Austin Company was a well-established and highly regarded company engaged in the total design-construction of buildings. Over the years, the company had developed fairly sophisticated steel framing systems including beams, columns, trusses and other prefabricated building components.

Nevertheless, shortly after the outbreak of the Korean War in 1951, there

Continuing from the previous issue, the author describes the highlights of the Austin Company prototype girder tests and the establishment of his precast prestressed plant in Tacoma, Washington. This company, together with the consulting firm he co-founded, designed and constructed many of the early innovative prestressed concrete structures across the United States.

developed a severe shortage of structural steel across the United States. To meet this challenge, the Austin Company began investigating the feasibility of using alternate building materials especially for industrial buildings.

This, of course, was the time when prestressed concrete was starting to emerge in North America as a strong contender in construction. Being a progressive company, Austin decided to initiate a major testing program for heavy-duty industrial building girders and other structural members using prestressed concrete.

Specifically, the company was looking into the possibility of using prestressed girders for industrial buildings with 40 x 60-ft (12.2 x 18.3 m) bays—at the time, the most common bay size.

One major objective of this particular series of tests was to evaluate the adequacy and comparative behavior of prestressed girders tensioned with bonded and unbonded tendons.¹⁶

To this end, three full-scale concrete girders were fabricated at the Austin Company. All three girders were cast using an 8-bag mix of ready-mixed concrete in order to attain a specified strength of 5000 psi (34.5 MPa). It might

be noted that one of the girders was made out of lightweight concrete.

Two of the girders had a span of 40 ft (12.2 m) while the third girder had a span of about 60 ft (18.3 m). The two 40-ft (12.2 m) girders were loaded with two equal concentrated loads at about the fourth points. The 60-ft (18.3 m) girder was loaded with two equal concentrated loads at the third points of the span.

One 40-ft (12.2 m) girder, which was designated P-40, used the headed wire prestressing system of the Prestressed Concrete Corporation of Kansas City. The other 40-ft (12.2 m) girder and the 60-ft (18.3 m) girder, designated as F-40 and F-60, respectively, used the prestressing system of the Freyssinet Company in New York.

There were significant differences in the designs of the three beams, the purpose being to secure as much experience and data as possible from the tests (see Figs. 36 through 41).

J. K. Gannet, chief engineer, and A. T. (Al) Waidelich, vice president and research chief, were the Austin Company representatives in charge of the project. I was responsible for the instrumentation and stress-strain analysis.

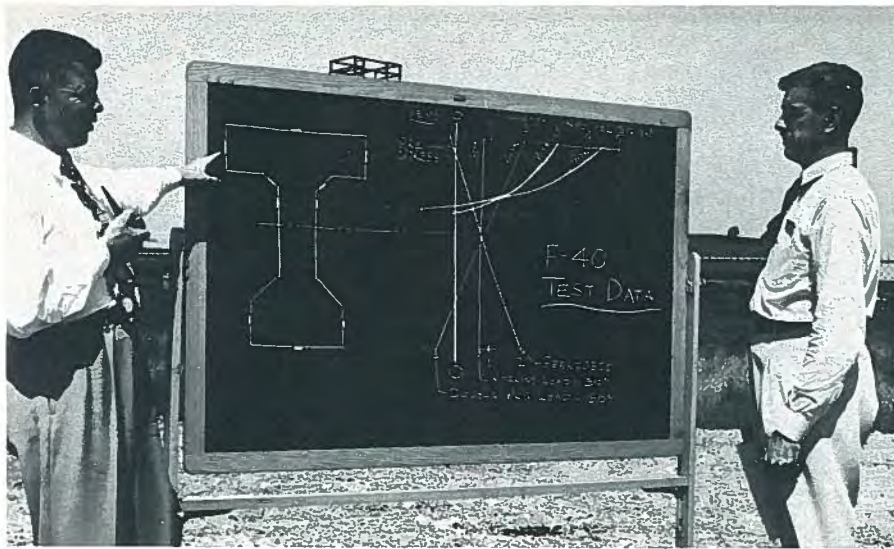

Fig. 36 The author (left) explaining to Al Waidelich (Austin Company Vice President) the stress distribution at different load levels during tests on 40-ft (12.2 m) prestressed girder (F-40) in Cleveland, Ohio (1951).



Fig. 37. An overflow crowd of invited guests witnessed the Austin Company tests in 1951. Three full-scale girders [two 40-ft (12.2 m) and one 60-ft (18.3) girders] were load tested using hydraulic jacks.

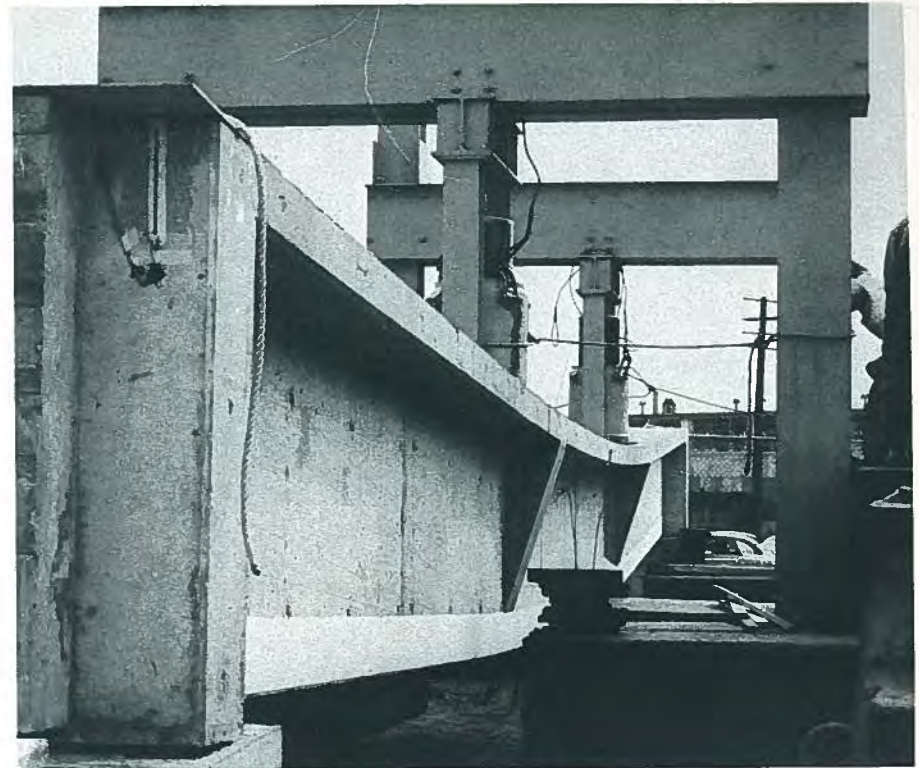

Fig. 38. Loading of 60-ft (18.3 m) prestressed girder (F-60) using bonded tendons. At four times the design load the girder deflected 12 in. (305 mm), displaying enormous ductility and prompting a reporter to headline "Rubber Concrete Carries Severe Overload."

The two girders using the Freyssinet system (F-40 and F-60 girders) were designed by Jean Muller and Neils Thorsen from the New York office of the Freyssinet Company. The 60-ft (18.3 m) girder was designed for a live load of 56 lbs/ft² (2.68 MPa) with girders on 20-ft (6.1 m) centers. It weighed 16 tons (14.5 t) and contained 1140 lbs (510 kg) of steel (about one-half mild steel and one-half prestressing wires).

At midspan, the F-60 girder had a modified T cross section: depth 40 in. (1016 mm), top flange 30 in. (762 mm) wide, 5 in. (127 mm) thick, web 6 in. (152 mm) thick, widening to 12 in. (305 mm) for bottom 7 in. (178 mm). The girder contained 96 wires in eight cables of 12 wires each, using a 0.192-in. (3 mm)

diameter wire as employed in the F-40 girder. The wires were, of course, grouted.

The P-40 girder [40 ft (12.2 m)] was designed for a live load of 75 lb/ft² (3.59 MPa) with girders 20 ft (6.1 m) on center and weighing 6¼ tons (5.7 t) including 536 lbs (240 kg) of steel. It had a modified T cross section, depth 40 in. (1016 mm), top flange 30 in. (762 mm) wide and 5 in. (127 mm) thick and web 6 in. (152 mm) thick.

Except for the end blocks, there were no stirrups or other mild steel reinforcement in the girder. The headed wire units were exposed (ungrouted) except at the ends. This unusual arrangement made it easy to measure the stress in the wires. Thirty-two ¼-in. (6.3 mm) di-



Fig. 39. Crack pattern in 40-ft (12.2 m) prestressed girder (P-40) using external unbonded tendons. The crack originated at midspan at bottom flange running up to the centroid of the girder and then branching out horizontally because no web steel was provided (Austin Company tests).



Fig. 40. Explosive failure (with top flange failing in compression) of 40-ft (12.2 m) girder (P-40) using unbonded tendons (Austin Company tests).



Fig. 41. After the dust settled, the author (center) and Al Waidelich inspect the fracture zone of 40-ft (12.2 m) test girder (P-40). The sudden uncontrolled failure dramatically persuaded the author to provide fully bonded tendons in all subsequent prestressed concrete construction.

ameter wires were used, manufactured by the Union Wire Rope Company.

After post-tensioning, the girders were load tested to destruction. As can be seen from Figs. 39, 40, and 41, the P-40 girder (with unbonded tendons) failed dramatically whereas the F-60 girder (with bonded tendons) showed considerable reserve ductility (see Fig. 38). During the load tests, Jean Muller, who was plotting outputs from the strain gages at girder midspan, was so impressed with the near-perfect linearity of strain distribution from top to bottom flanges that he was overheard commenting "fantastique."

The results of the Austin Company

tests gave dramatic proof of (1) the superior capabilities of prestressed concrete construction and (2) the ductile behavior of fully bonded prestressed beams. They also provided valuable information on the structural behavior of both normal weight and lightweight prestressed concrete. One other beneficial outcome of the Austin tests was the close personal relationship I developed with Al Waidelich, Austin's research chief.

Upon completion of the tests, Gannet, Austin's chief engineer, observed that: "If prestressed concrete is to be used in this country as anything more than an emergency expedient in building con-

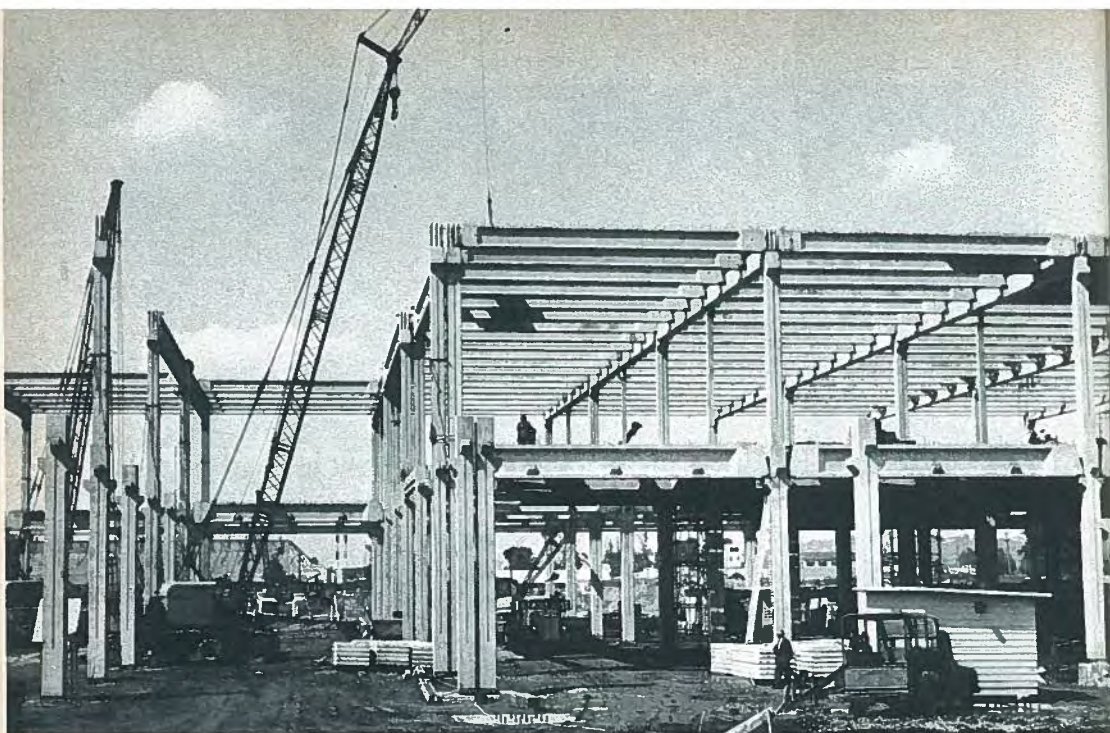

Fig. 42. Erection of giant Boeing Company development center in Seattle, Washington, 1956. The two-story 400 x 600 ft (122 x 183 m) precast prestressed structure with 40 x 60 ft (12.2 x 18.3 m) bays was completed in 7 months and at the time was the largest industrial-type prestressed building in the world.

struction, it will have to be on the basis of competitive advantages" and went on to say that "One of the greatest advantages to be obtained by shop fabrication of prestressed concrete is in controlling quality and the more efficient equipment for external vibration of controlled slump concrete." These words turned out to be most prophetic not long thereafter.

Gannet predicted that the development of standard sections for single- and multistory buildings would greatly simplify the many problems with clients, building officials, and contractors.

Boeing Development Center

The Austin Company's research bore fruit only 5 years later when they built the giant Development Center for the Boeing Company in Seattle, in 1956. The structure consists of 114 typical 40 x 60-ft (12.2 x 18.3 m) two-story ele-

ments (see Fig. 42.). Precast columns are alternately 50 and 25 ft. (15.2 and 7.6 m) high.

The roof girders span 60 ft (18.3 m) and carry 40-ft (12.2 m) purlins spaced on 10-ft (3.05 m) centers. In the second floor the girders span 40 ft (12.2 m) and carry 30-ft (9.2 m) beams spaced on 10-ft (3.05 m) centers. All the girders, purlins and beams were precast and prestressed.

One notable feature of the Boeing job was the mass production of 4-in. (102 mm) thick, 20-ft (6.1 m) wide by 40-ft (12.2 m) long lightweight concrete panels. These unusually large panels were cast (in assembly line fashion) on an improvised pretensioning bed.

At the time the Boeing building was built (1956), it was reported to be the largest prestressed concrete industrial building in the world. The published

paper (Reference 17) describing the project won the ACI Construction Practice Award for that year.

The designer of the Development Center was Austin Associates, with my old friend Al Waidelich in charge. It might be worthwhile to mention that, for 6 months, I commuted practically every day to Seattle where I participated with Al Waidelich in the conceptual design and construction of the Boeing project.

Establishment of Tacoma Plant

Upon completion of the Austin Company tests in Cleveland, Ohio, my westward journey to Tacoma, Washington, was resumed. When I arrived in Tacoma, in July of 1951, my brother Thomas and I co-founded Concrete Engineering Company with the objective of manufacturing precast prestressed products.

Our decision to form the venture was predicated on several reasons.

- My experiences with the Walnut Lane, Pottstown and Austin Company prototype girders convinced me that prestressed concrete would become a major construction material in the United States.

- Our fact-finding tour of precast and prestressed developments in Europe persuaded me that mass produced prestressed concrete under controlled factory conditions was the way to go in the United States.

- The Pacific Northwest had already acquired a good record for concrete construction.

- There was a plentiful supply of raw materials in the area. (Cement, sand and gravel including lightweight aggregates were abundant.)

- The entire United States was in the midst of a major building boom. In addition, the interstate highway bridge program was beginning to gather momentum.

- The City of Tacoma Building Inspector, C. S. McCormick, was progressive and receptive to new innovations in construction.

- Last, but most importantly, there was a shortage of structural steel (in the early fifties) in the United States.

Prior to building the plant, we embarked upon a marketing and feasibility study to determine whether such an enterprise could succeed in the United States and be financially sound.

We quickly determined that we could obtain cement, sand, gravel, crushed stone, lightweight aggregates, plus prestressing steel and mild reinforcing steel. Our proximity to the sea and inland waterways plus our closeness to major highways and railroads would facilitate the transportation of both incoming raw materials and outgoing finished products. In addition, labor was relatively cheap.

A market survey showed that there was a demand for piles, sheet piling, transmission poles, beams and girders, roof and floor slabs, wall panels and other special sections. These elements would be needed in constructing commercial, institutional and industrial buildings, bridges, marine structures, stadiums and many other diverse structures.

A quick estimate showed that we would need an immediate initial investment of at least \$200,000. Plant facilities would include an office building for administrative and engineering services, and a research laboratory. The production facility included the stressing bed, a concrete batching and mixing plant, and overhead crane services for handling pretensioned beams up to 100 ft (30.5 m) in length, weighing up to 35 tons (31.7 t).

It was estimated that about 10 acres of land was needed initially, although it was felt that additional space would be needed for future expansion of plant facilities.

What it Takes to Convert Prestressed Concrete into a Preferred Construction Material

by ARTHUR R. ANDERSON

Written 25 years ago, many of the ideas presented in this article are still pertinent today.

A new building material is making its impact on architecture, engineering and construction. Only recently, the prestigious *Wall Street Journal* featured a front page column under the headline "Prestressed Concrete Stars as a Substitute for Scarce Steel Beams."

No one will doubt that the steel shortage has created a market for prestressed concrete. However, anyone giving serious consideration to entering the prestressed concrete business should have more than a structural steel shortage as his incentive for "jumping in."

During the past few years, prestressed concrete has clearly grown from a substitute material to a recognized and indeed preferred construction method for many types of structures.

To build a successful prestressed concrete business, a potential investor should have answers to the following questions:

1. What is the potential market?
2. How can this market be developed; and how much of it can I reasonably expect to get?
3. What types of products should the plant manufacture?
4. What are the technological aspects, and what kind of people constitute the successful organization of a successful prestressed concrete business?
5. What kind of plant, equipment, and

facilities are required?

6. How much land is required for a suitable plant site?
7. How much money will be required?

For an investor, Questions 1 and 2 are the most important. In the foreseeable future, the market potential for prestressed concrete appears excellent. The multi-billion dollar federal highway program will require thousands of structures, ideally constructed from prestressed concrete. New construction of schools and other public buildings will continue at a high rate because of the continuing population growth in the United States.

Expansion in industry goes ahead at top level, to keep pace with the increasing market for products demanded by a nation whose standard of living is constantly rising. Thus, a tremendous potential market for basic structural elements in prestressed concrete already exists.

Assuming that an investor decides to get into the prestressing business, he should get the best technical advice on how to get started. He should know the difference between post-tensioning and pretensioning, and the advantages of both systems. He should determine whether he wants to pursue an "on-the-job" or factory type of production. Both methods will have their place in the future of the American construction industry.

I believe that the high standard of living in the United States has resulted from mass production of consumer goods in well-managed factories with production-line methods. For this reason, the future for the long range success of prestressed concrete should also be based on mass production in a factory. This leads up to Question 2 above, namely, "How can this market be developed?"

Promoting and selling prestressed concrete is highly technical. It would be extremely difficult for a salesman to make calls on prospective customers, and bring back a book full of orders. On the contrary, selling prestressed concrete must start at the outset of the design of a new project.

Selling of this kind requires a company representative capable of calling on engineers and architects at the preliminary design stage. The sales representative should be qualified to discuss intelligently the designer's problems; and above all, he must be well-armed with cost data. Just as with all types of engineering sales, it is the person best equipped with good technical answers who has the best chance of eventually getting the order for his company.

From my experience, progress in factory-produced prestressed concrete construction will be tremendously influenced by the ability and imagination of designers, namely, the Architects and Engineers. Fortunate indeed is the company that has on its staff a design consultant with enough creative ability and imagination to develop structures with architectural composition of enduring beauty derived from the repetition of a few basic standard elements—in this case, from precast and prestressed concrete produced by mass production.

Thus, one of the big selling jobs in the prestressed concrete business is really "how to design it." It is important to keep the number of element types to a minimum and the number of each type maximum, and equally important to consider details of the connections in the field.

A good designer has a feeling for problems of connecting the structural

elements, and a knowledge of how much a crane can lift at a given radius and what kind of dimensional tolerances to allow in precast concrete elements. He understands the forces and movements caused by temperature changes as well as those caused by deflection due to design loads.

A good designer must also develop a sense of balance between material and labor costs. Granted that our economy attaches a premium to labor cost as contrasted with the European practice of trying to save every pound of material; yet I have seen many examples of prestressed concrete structures in the United States where a considerable amount of material could have been saved without increasing the labor cost.

You may well ask, "Why all the fuss about design to sell prestressed concrete?" The answer to this goes back to the opening paragraph in this article regarding the use of prestressed concrete as a substitute for scarce steel. When steel becomes plentiful again, where will the market be for prestressed concrete? Obviously, to be competitive with steel or other construction materials, prestressed concrete must become a preferred material of construction, and this idea must be "sold" to the people who do the design.

It will be up to the manufacturers of prestressed concrete to see that the designers are sold. To do this:

- The company looking for a market in prestressed concrete must be prepared to develop standard structural sections comparable to the standard rolled steel sections.
- Moreover, the company must be in a position to produce these sections to a guaranteed performance, and provide adequate design information about these standard sections to those who would be in a position to specify them.
- Lastly, and most importantly, the company must have a knowledgeable technical salesman to call upon architects and engineers at the preliminary and actual design phases of a project.



Fig. 43. Erection of Concrete Engineering Company shop building (1951).

The realities of winning acceptance for our products hit us immediately. We had originally intended to build our plant in Seattle. However, the City Building Department refused to issue us a permit on the grounds that prestressed concrete was not recognized in their city building code.

So we then approached the Tacoma City Building Department.

When we submitted our plans to Building Inspector C. S. McCormick, he responded by saying that the City of Tacoma had no code for prestressed concrete, and therefore he saw no reason to prevent us from going ahead with the proposed construction. Since the building was experimental, and located on our own property, he waived the building permit requirement, and wished us success!

"Of course," said McCormick, "you are professional engineers, and I am confident that you know what you are doing." Naturally, we were elated with the magnanimous consideration and encouragement given us.

We proceeded forthwith (in late 1951) on the construction of a 30 x 60-ft (9.15 x 18.30 m) precast reinforced concrete building to serve as our office and mechanical shop. This building featured clear-span rigid frames and precast wall and roof panels (see Fig. 43).

The pilot plant was a building 45 x 140 ft (13.7 x 42.7 m) in plan, erected on a heavily reinforced mat designed to serve as the casting bed (see Fig. 44). Columns were T-shaped, with a 5-in. (127 mm) thick web and a 12-in. (305 mm) flange.

Precast wall panels, 12 ft x 19¼ ft x 4

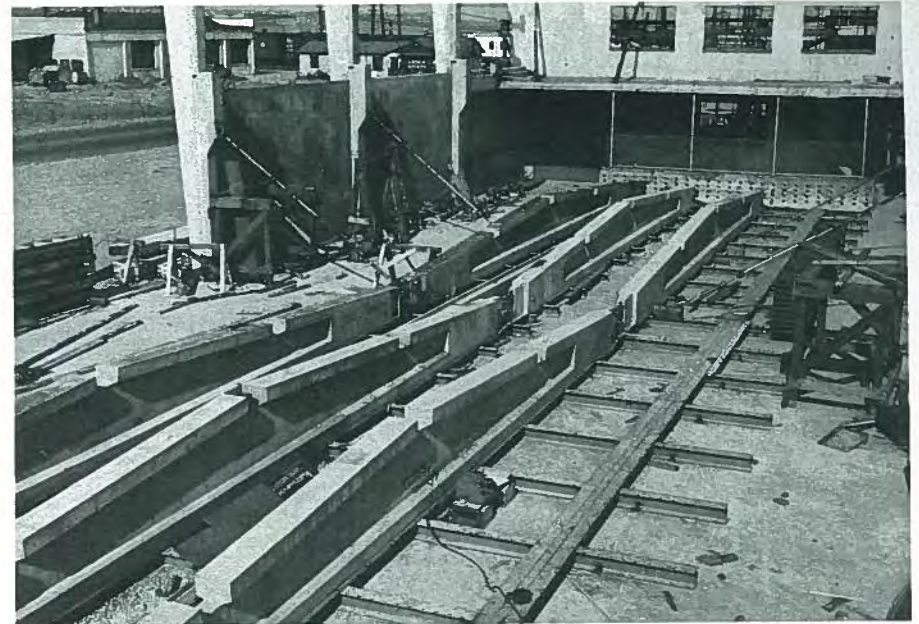

Fig. 44. 105-ft (32 m) long pretensioning bed showing freshly cast prestressed roof girders for new Concrete Engineering Company plant in Tacoma (1951).

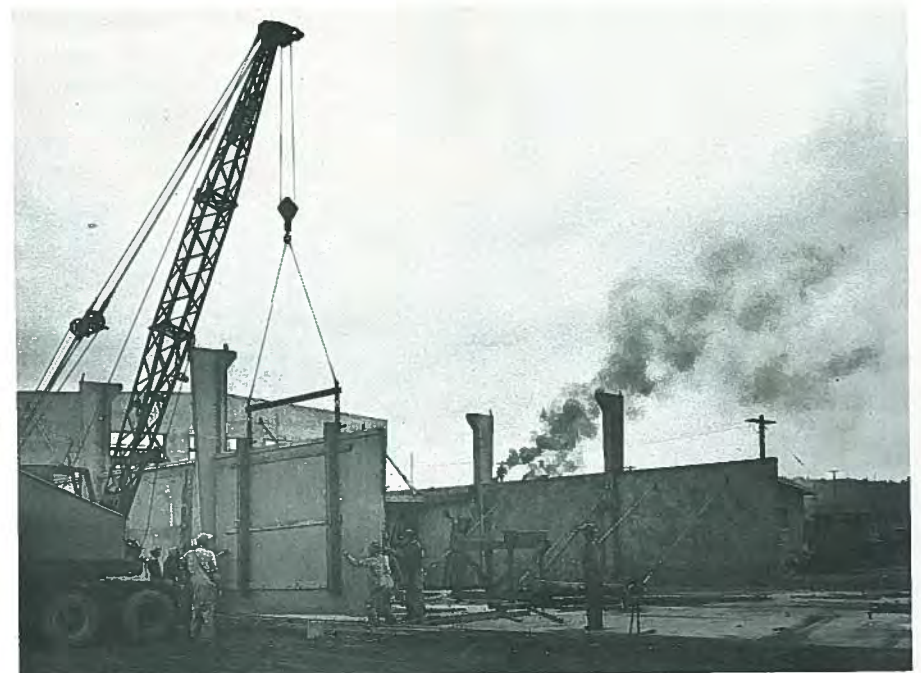

Fig. 45. Erection of precast columns and wall panels of Concrete Engineering Company plant.

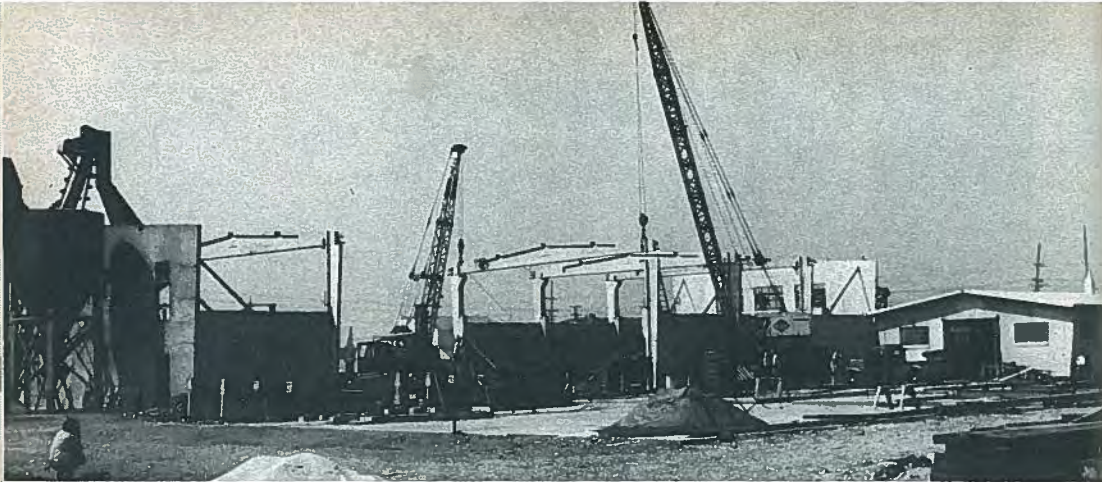

Fig. 46. General view of erection operations of plant for Concrete Engineering Co.

in. (3.6 m x 5.9 m x 100 mm), were anchored in the columns (see Figs. 45 and 47). Note that the wall panels were surmounted by window casings with 3 x 4-in. (76 x 102 mm) prestressed mullions.

The roof deck was made of prestressed concrete slabs 2 in. (51 mm) thick and 25 ft (7.6 m) long supported on prestressed purlins notched into the top flange of prestressed roof girders. An overall view of the erection operation

can be seen in Fig. 46. A closer shot of the erection of the roof girders is shown in Fig. 47.

The stressing bed for our production facility (see Fig. 44) was 105 ft (32 m) between abutments, varying in thickness from 2 to 3 ft (0.6 to 0.9 m). The slab was heavily reinforced because it was expected to serve as a reaction floor for large full-scale tests as well as for production of beams up to 100 ft (30.5 m) in length. [It must be appreciated that in

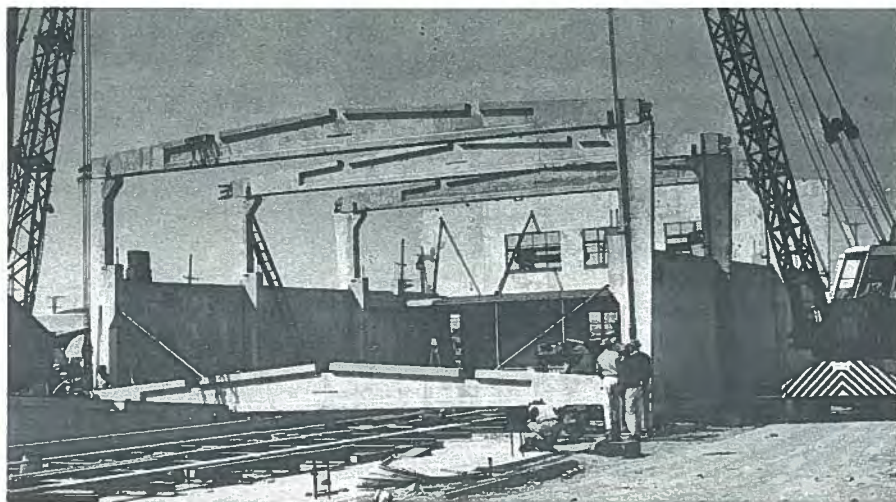

Fig. 47. Erection of prestressed roof girders of Concrete Engineering Co. plant.

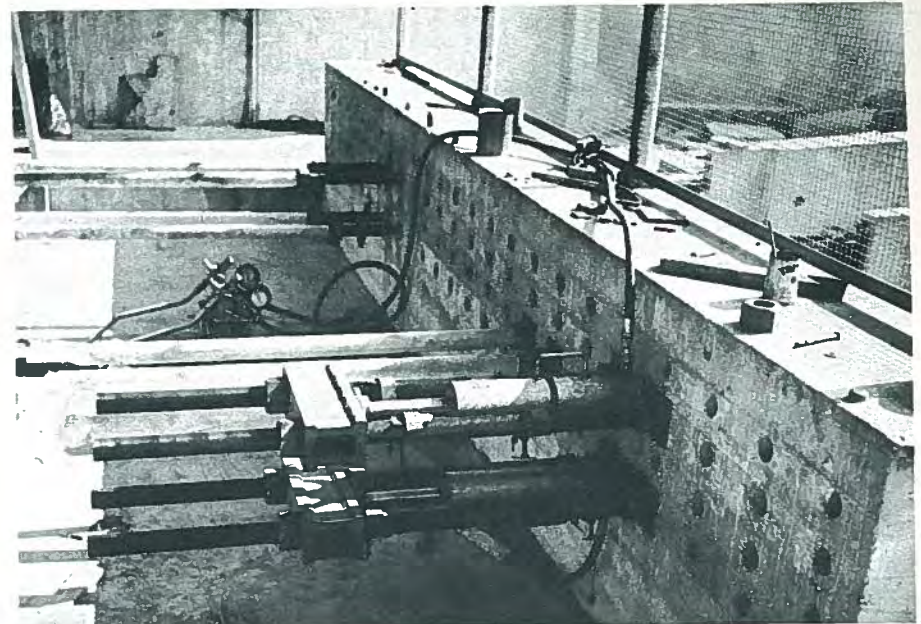

Fig. 48. For prestressing the wires, hydraulic jacks act against heavy reinforced concrete abutments.

1951, a 100-ft (30.5 m) long factory-produced beam was considered the top limit for highway transportation.]

Fig. 48 shows the hydraulic jacks and anchorage system at one end of the heavily reinforced abutment. Fig. 49 is a closeup of my brother Tom and myself checking the compressive strength of the concrete abutment with a Schmidt test hammer.

During construction of the pilot plant we also built an outdoor pretensioning bed (see Fig. 50). This bed was used to cast the window panels of the pilot plant.

The Tacoma plant structure is recognized as one of the very first totally precast prestressed buildings in North America. Further details of the pro-



Fig. 49. The author (right) and his brother Thomas Anderson checking concrete strength of abutment with Schmidt test hammer (1951).

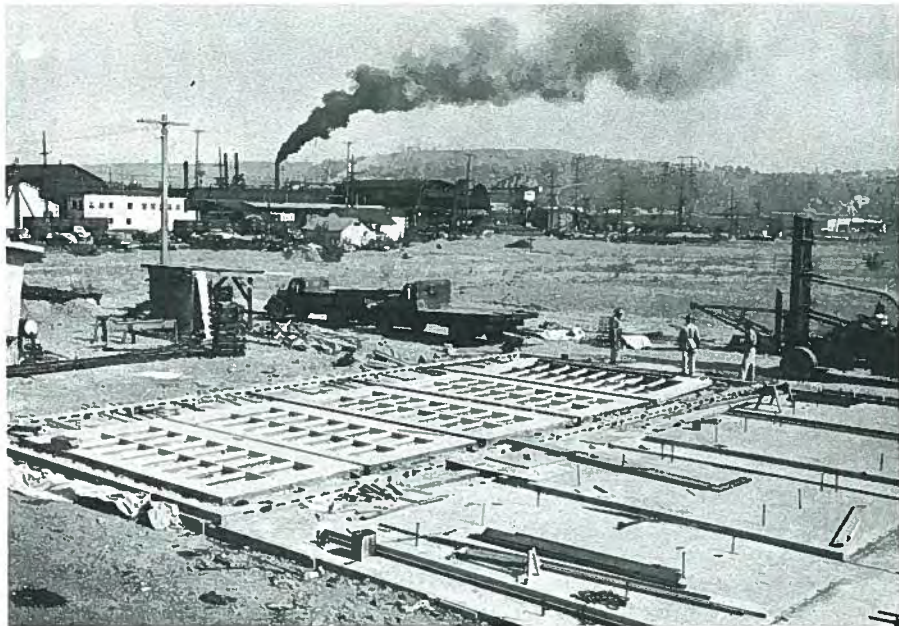

Fig. 50. Outdoor casting yard for Concrete Engineering Company (1951). Note that the window frames, which were cast on the floor slab, were prestressed in both directions simultaneously.

duction and erection of the plant are given in References 18-20. A few years later we built a precast prestressed barrel shell carport for "fun" (see Fig. 51). In 1956, for curiosity, we also made a Möbius slab chair out of precast concrete (see Fig. 52).

A word now on our materials and production techniques because, very early in our development, we produced a zero-slump concrete with compressive

strengths ranging up to 10,000 psi (69 MPa). It must be appreciated, of course, that in 1951 concrete strengths much beyond 3000 psi (20.7 MPa) were a rarity in North America.

For materials, we used pretensioned carbon steel wires imported from the Bethlehem Steel Company. (Note that seven-wire stress-relieved strand was not readily available in the Tacoma area in 1951.) The wire was a billet steel,



Fig. 51. Precast prestressed concrete barrel shell carport for Concrete Engineering Company (1953).

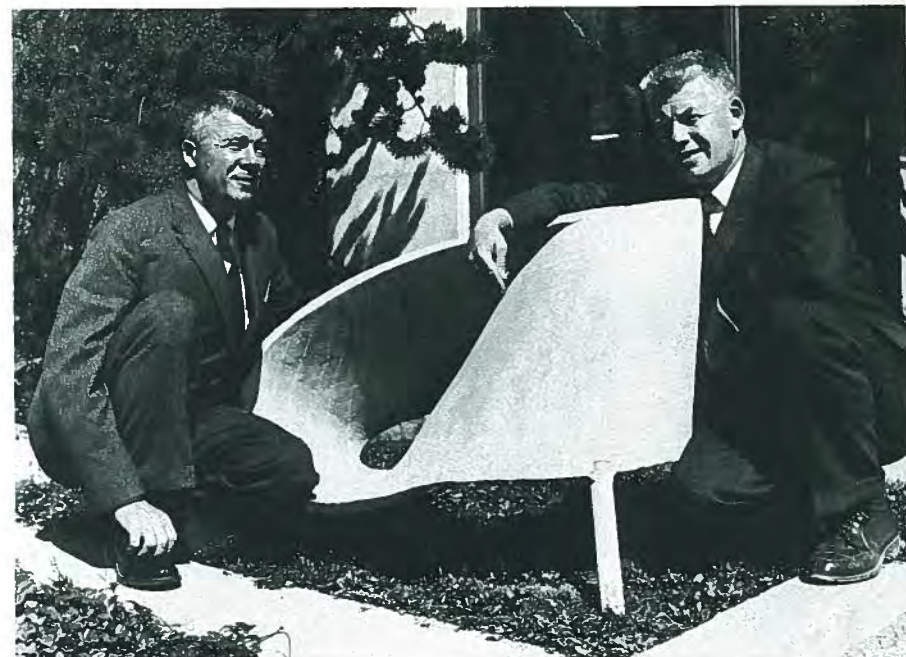

Fig. 52. The author (left) and his brother Tom display "Möbius" chair slab made out of precast concrete (1956).

0.16 in. (4 mm) in diameter with a breaking strength of 150,000 psi (1034 MPa). It was initially tensioned to 120,000 psi (827 MPa).

Ready-mixed concrete, containing 750 lbs of Type III cement per cu yd (1116 kg/m³), was used in a mix having a 0.35 water-cement ratio. A 2 percent calcium chloride additive (accelerator) was used resulting in 1-day concrete strengths of 4000 psi (27.6 MPa). In fact, 28-day strengths exceeding 7500 psi (51.7 MPa) were routine. It might be noted that no steam curing was used at that time.

Literally hundreds of precast prestressed structures and laboratory specimens (with calcium chloride present) survive today still showing excellent durability. Unfortunately, based on some bad experiences with calcium chloride in Western Canada and an adverse research investigation in England on the subject, the use of calcium chloride in

prestressed concrete was prohibited in the late fifties, by all specifications and codes of practice.*

To achieve a no-slump concrete, we used a 1/3-cu yd (0.25 m³) capacity mixer imported from Sweden. The mixer consisted of a stationary tub with rotating paddles. This mixer was basically a "horizontal" pan mixer similar to the "Eirich" type.

The key to placing no-slump concrete was the use of powerful high-frequency (7000 rpm) vibrators clamped to the

*For more detailed information on this subject see the articles: "Use of Calcium Chloride in Prestressed Concrete," by R. H. Evans, *Proceedings, World Conference on Prestressed Concrete*, San Francisco, California, July 1957, pp. A31-1-8; and "Corrosion of Prestressed Wire in Concrete," by G. E. Monfore and G. J. Verbeck, *ACI Journal, Proceedings* V.57, No. 5, November 1960, pp. 491-515. The article by Harry Edwards on "The Innovators of Prestressed Concrete in Florida" (Sept.-Oct. 1978 *PCI JOURNAL*, p. 43) might also be of some interest regarding some parallel experiences with calcium chloride in Florida.

To the Three Messrs ANDERSON
Prestressed Concrete Manufacturing Co.
Tacoma, Washington
United States

G. MAGNEL
Ingénieur A.I.G.
Professeur
à l'Université
Ghent, Belgium

March 3, 1954

Dear Sirs:

The visit to your factory was the most interesting one I had the opportunity of making in the United States.

May I sincerely congratulate you about your work. It is the only place I saw in the States where prestressed work is done with the utmost perfection.

You give in practice the answer to the question as to whether the economical situation in the States (relation between cost of labor and building material) does allow making first class concrete products as in Europe.

My efforts to make prestressed concrete known in the States have had up to now little results; with the exception of Walnut Lane Bridge, nothing very important has been achieved. Your work is a second step and you may be proud of what you have achieved.

I wish you every success in the future.

Yours very sincerely,

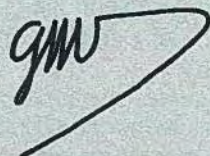

Fig. 53. Original letter from Professor Magnel regarding his Tacoma plant visit.

forms. This equipment made the concrete "flow like melting butter on a hot skillet."

Since no equipment of this kind was available, I developed and patented the Anderson vibrator for external consolidation. This was a simple apparatus with steel discs eccentrically mounted on a flywheel and powered by a belt-driven electric motor.

In 1954, during Professor Magnel's

last lecture tour of North America, we were privileged to have a visit from the eminent professor at our Tacoma plant. He was particularly impressed by our manufacturing and testing facilities and especially in our techniques for producing high strength concrete using zero-slump concrete. Upon his return to Belgium, Professor Magnel expressed his observations in a gracious letter to us (see Fig. 53).

Formation of Consulting Firm

By 1952 it became apparent that CEC's engineering services would more effectively be handled (with less conflict of interests) if an independent consulting firm, separate from the production functions, were formed. Therefore, my brother Tom and I co-founded the consulting firm Anderson and Anderson.

In 1956 Halvard Birkeland joined the firm and two years later Robert Mast (both as principals). The name of the firm then assumed the acronym ABAM Engineers.

The original company (CEC) changed its name to Concrete Technology Corporation confining its activities to production, testing and developmental research.

ABAM Engineers was responsible for performing the conceptual and engineering design of many of the notable prestressed concrete structures described later on in this article. However, it should be emphasized that ABAM Engineers is a totally independent firm which performs many other consulting services for projects not directly related to Concrete Technology Corporation.

During the early fifties I taught a course on prestressed concrete at the University of Washington. Despite the added burden this lecturing imposed upon me, two major benefits ensued from this experience:

1. In preparing my lectures, I was forced to do my own "homework," thereby helping bridge an important gap between theory, design, and practice.
2. The lectures helped familiarize many new young engineers with the capabilities of prestressed concrete.

High Strength Standard Prestressed Products

Our goal from the beginning (1951) was to engineer and produce high per-

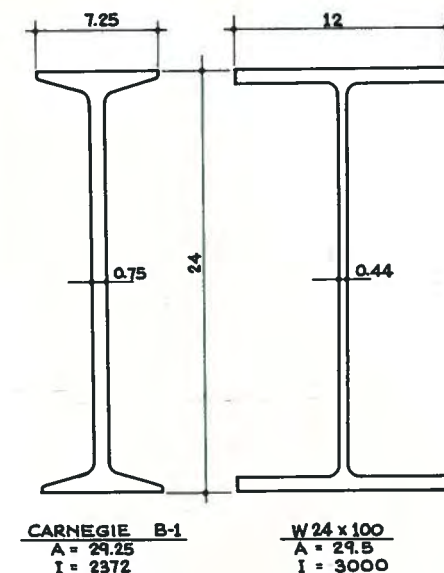

Fig. 54. Comparison of section efficiency of old Carnegie steel beam and later wide flange steel beam.

formance structures. To achieve this objective, I became convinced we needed to develop a series of standard prestressed sections which would provide an alternate to the existing selection of structural steel shapes. Moreover, the sections would be of a high quality concrete approx. 7500 psi (51.7 MPa).

Our criteria for choice of section included:

- Section efficiency in terms of load-span capability. The beams should have the required live load capacity for minimum dead load and section area.
- Flexibility. The beam section should be adaptable to a wide range of spans. In the case of bridges one set of steel forms should serve all such structures within this range.
- Economy. Both section efficiency and flexibility should be combined with a choice of beam design for which labor and material costs are minimized. Moreover, the beam

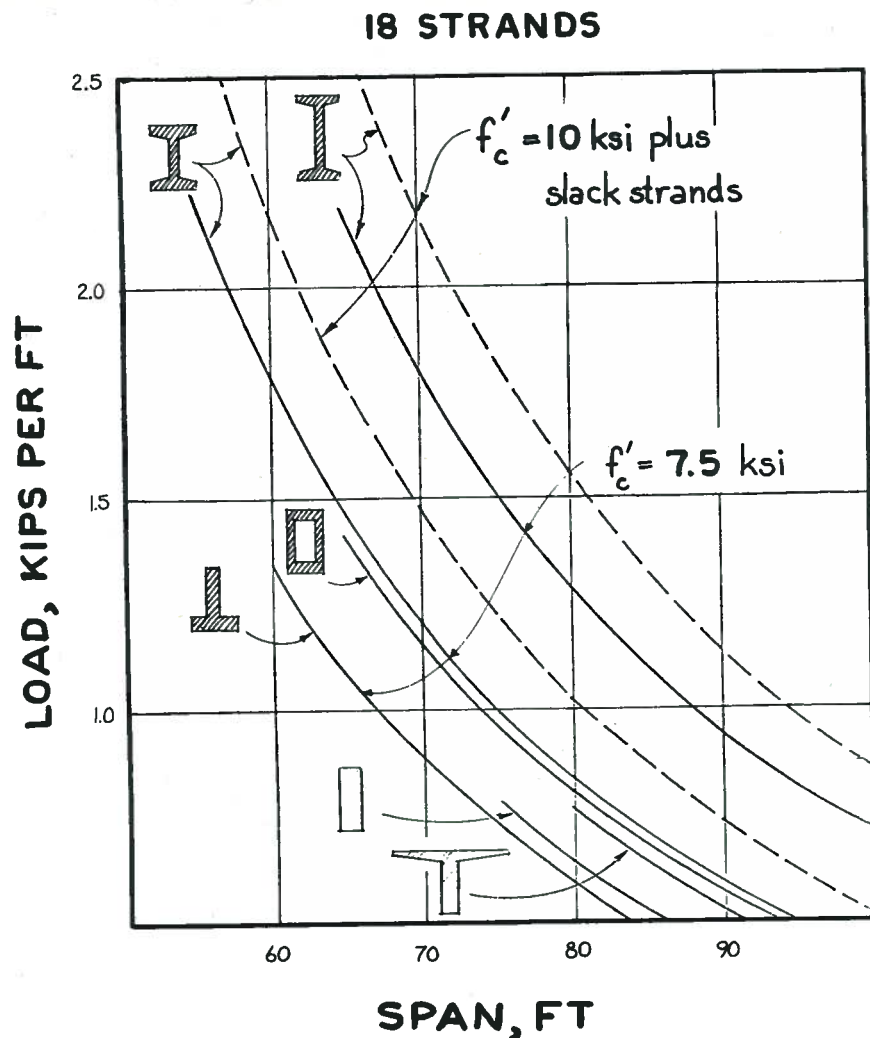

Fig. 55. Performance comparison of various prestressed beams having equal section areas.

must be capable of being transported and erected in possibly rugged terrain away from the fabricating plant.

- Cost-efficient production tooling and economical plant operations.
- Guaranteed quality assurance.

In evaluating section efficiency, I recalled the comparison between the old Carnegie I-section and the Bethlehem wide-flange section (see Fig. 54), where

a 26 percent increase in capacity can be obtained for the same weight of steel.

Similarly, we analyzed the performance efficiency of various concrete sections, e.g., solid rectangular, hollow-box, T, inverted T, and I sections (see Fig. 55). In the chart the curves were based on a 28-day concrete strength of 7500 psi (51.7 MPa) with additional curves for the I-sections with a 10,000-psi (68.9 MPa) strength.

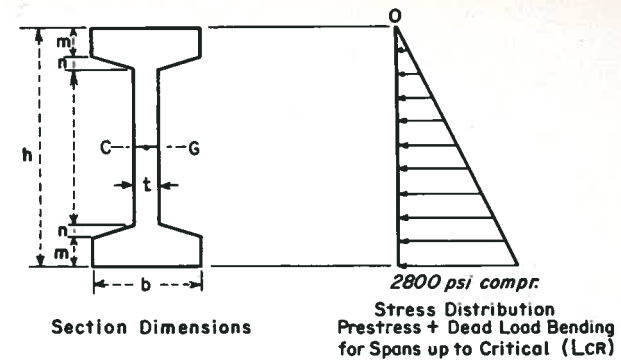

Beam Symbol	Wt. per Foot Lb	Area In. ²	b In.	h In.	Z In. ³	I _{CG} In. ⁴	L _{CR} Ft.	Max M _s [†] K-Ft.	t In.	m In.	n In.
IB 12/24	155	148	12	24	916	11,000	53	214	3	3 1/2	1 1/2
IB 12/28	167	160	12	28	1169	16,360	60	272	3	3 1/2	1 1/2
IB 12/32	179	172	12	32	1438	23,000	67	336	3	3 1/2	1 1/2
IB 12/36	196	184	12	36	1723	31,020	74	402	3	3 1/2	1 1/2
IB 15/32	248	238	15	32	1945	31,120	71	454	4	4	2
IB 15/36	265	254	15	36	2340	42,100	76	546	4	4	2
IB 15/40	281	270	15	40	2757	55,120	81	643	4	4	2
IB 18/36	325	312	18	36	2990	53,770	73	698	4	5	2
IB 18/40	342	328	18	40	3510	70,260	78	819	4	5	2
IB 18/44	358	344	18	44	4060	89,340	83	948	4	5	2
IB 18/48	375	360	18	48	4640	111,300	88	1084	4	5	2
IB 18/52	392	376	18	52	5240	136,170	92	1224	4	5	2
IB 18/56	408	392	18	56	5850	163,800	96	1365	4	5	2
IB 24/48	547	525	24	48	6820	163,830	89	1592	5	6	3
IB 24/52	568	545	24	52	7720	200,570	92	1802	5	6	3
IB 24/56	588	565	24	56	8630	241,730	95	2015	5	6	3
IB 24/60	610	585	24	60	9570	287,100	100	2232	5	6	3

[†] Maximum superimposed moment

Fig. 56. Properties for design of CEC standard prestressed I-beams. Note that L_{CR} is the limiting span for which beam dead load moment theoretically counteracts applied prestressing moment.

All sections contained 432 sq in. (268,709 mm²) and an equal number of tendons which were assumed straight. An effective precompression of 2800 psi (19.3 MPa) was assumed.

From an analysis of curves such as those shown in Fig. 55 (plus other data), we developed properties for the design of rectangular and I-section beams (see Fig. 56). Similarly, we developed properties for the design of composite sections.

These were channel slabs, having a 6 and 8 in. (152 and 203 mm) depth and a

variable width, acting compositely with I-beams for floor and roof systems. One such example for 8-in. (203 mm) channel sections is shown in Fig. 57.

In addition, load-span curves were developed for determining the load capacity for various beams and composite sections. Building illustrations for the application of beams and channel slabs were prepared as shown in Figs. 58 and 59.

Despite our enthusiasm and faith in the long-term potential for factory-produced precast and prestressed con-

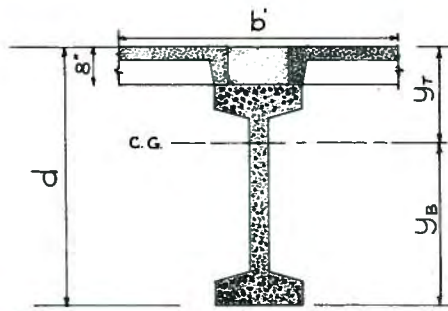
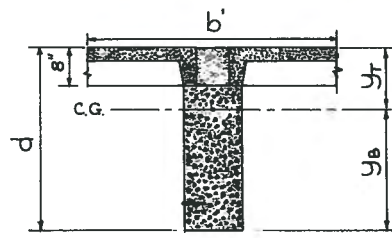

PRESTRESS BEAM SYMBOL	b	d	I	y _T	y _B	Z _T	Z _B	MAX M _s K-FT.
	IN.	IN.	IN. ⁴	IN.	IN.	IN. ³	IN. ³	
RB 9/18	48	26	20,190	9.2	16.8	2200	1200	280
RB 9/20	48	28	25,200	10.0	18.0	2500	1405	328
RB 9/22	48	30	30,700	10.9	19.1	2800	1610	376
RB 9/24	48	32	36,820	11.9	20.1	3100	1830	427
RB 9/26	48	34	43,720	12.8	21.2	3420	2060	481
RB 9/28	48	36	51,300	13.7	22.3	3750	2300	537
RB 9/30	48	38	59,700	14.6	23.4	4080	2550	595
RB 9/32	50	28	29,470	10.6	17.4	2770	1700	397
RB 9/32	50	30	35,870	11.6	18.4	3100	1945	454
RB 9/32	50	32	43,020	12.5	19.5	3440	2200	513
RB 9/32	50	34	51,050	13.4	20.6	3800	2490	581
RB 9/28	50	36	60,000	14.4	21.6	4180	2770	646
RB 9/30	50	38	69,900	15.3	22.7	4570	3080	719
RB 9/32	50	40	80,600	16.3	23.7	4960	3390	792
RB 12/24	52	32	49,120	13.0	19.0	3790	2575	601
RB 12/26	52	34	58,280	13.9	20.1	4195	2900	677
RB 12/28	52	36	68,530	14.9	21.1	4620	3240	756
RB 12/30	52	38	79,800	15.8	22.2	4980	3550	828
RB 12/32	52	40	92,070	16.8	23.2	5380	3865	902
RB 12/34	52	42	105,700	17.7	24.3	5960	4360	1018
RB 12/36	52	44	120,440	18.7	25.3	6620	4750	1110

PRESTRESS BEAM SYMBOL	b	d	I	y _T	y _B	Z _T	Z _B	MAX M _s K-FT.
	IN.	IN.	IN. ⁴	IN.	IN.	IN. ³	IN. ³	
IB 12/24	52	32	36,550	10.1	21.9	3620	1,668	389
IB 12/28	52	36	49,560	11.3	24.7	4370	2,010	469
IB 12/32	52	40	65,000	12.6	27.4	5,150	2,372	554
IB 12/36	52	44	86,300	13.9	30.1	6,190	2,870	670
IB 15/32	55	40	82,720	13.8	26.2	5,990	3,160	738
IB 15/36	55	44	105,800	15.2	28.8	6,960	3,670	856
IB 15/40	55	48	132,330	16.7	31.3	7,940	4,220	984
IB 18/36	58	44	126,870	15.8	28.2	8,000	4,500	1,052
IB 18/40	58	48	158,460	17.3	30.7	9,170	5,150	1,202
IB 18/44	58	52	194,040	18.7	33.3	10,350	5,860	1,368
IB 18/48	58	56	234,400	20.2	35.8	11,650	6,560	1,531
IB 18/52	58	60	279,470	21.7	38.3	12,850	7,300	1,705
IB 18/56	58	64	328,800	23.3	40.7	14,100	8,080	1,885
IB 24/48	64	56	320,800	21.7	34.3	14,800	9,340	2,180
IB 24/52	64	60	381,500	23.2	36.8	16,420	10,370	2,420
IB 24/56	64	64	450,700	24.8	39.2	18,200	11,480	2,680
IB 24/60	64	68	524,800	26.4	41.6	19,900	12,600	2,940

Fig. 57. Properties for design of CEC standard composite sections (prestressed beams and precast channel slabs, S24/8).

crete structures, it soon became apparent that we were naive in assuming that customers would beat a path to our door with orders for our products. On the contrary, most engineers and contractors in the Northwest predicted a gloomy future for our enterprise. They would exclaim, "The Andersons are sharp on theory but short on practice!"

After several frustrating months, we concluded that our initial marketing effort needed to include preparation of alternate designs when permitted by the

client. In fact, most general contractors also welcomed alternates, especially at a time when structural steel was scarce (due to the Korean War).

Connections

During our formative years (in the early fifties) we devoted much attention to seismic design and the attendant problems involving joints and structural connections. A major problem arose on the question of tension connections especially as regards welding of pro-

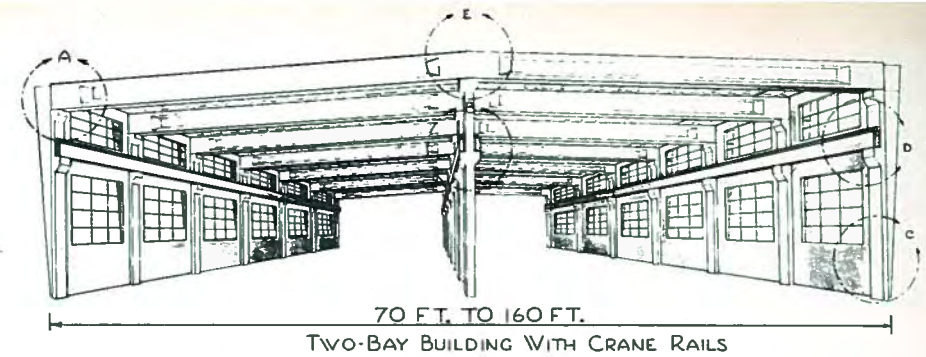

70 FT. TO 160 FT.
TWO-BAY BUILDING WITH CRANE RAILS

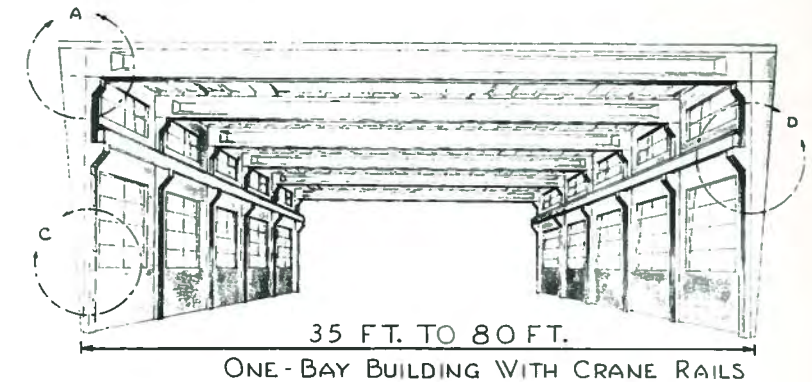

35 FT. TO 80 FT.
ONE-BAY BUILDING WITH CRANE RAILS

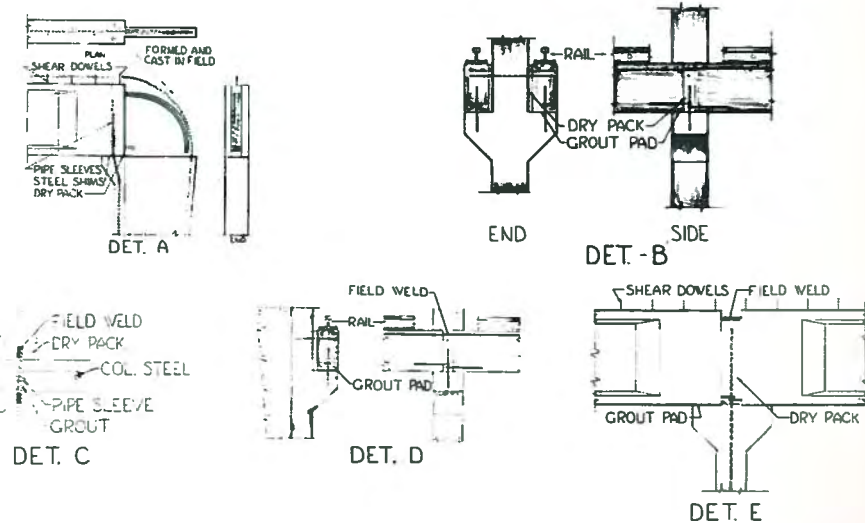

Fig. 58. Drawings for two-bay and one-bay buildings with crane rails.

jecting reinforcing bars. We devised procedures to solve this problem. We also developed details for column-to-footing, wall-to-column and beam-to-column connections.

These connection details (published in References 22-24) provided much needed information to architects and engineers in the late fifties and early sixties.

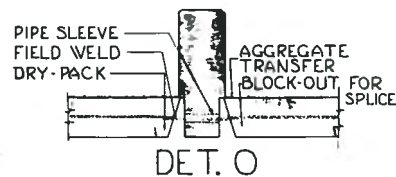
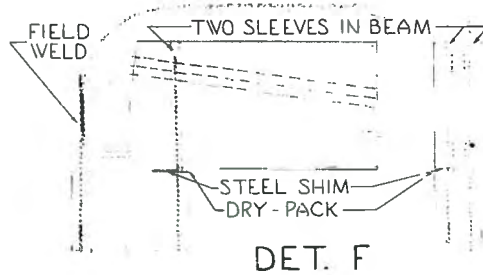
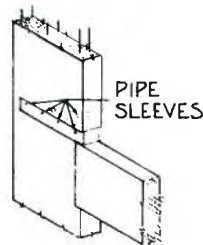
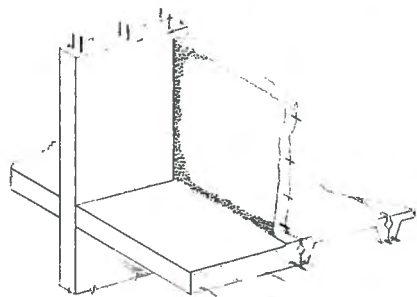
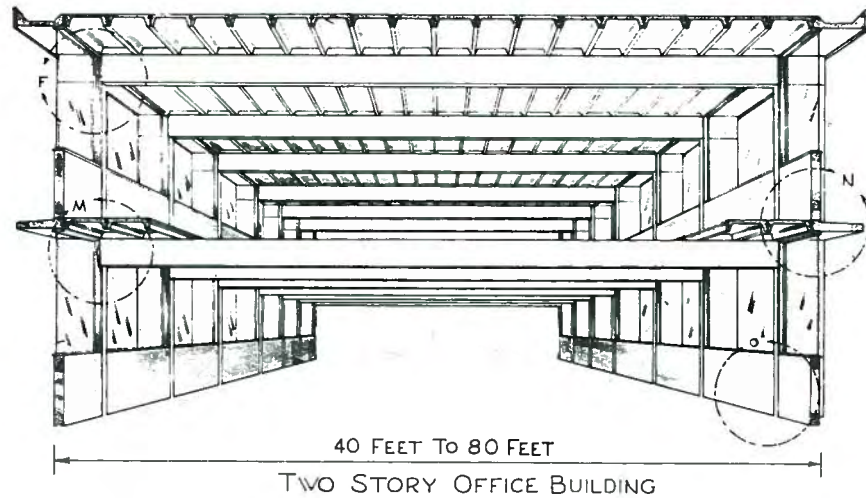

Fig. 59. Drawings for two-story office building.

Shear-Friction Concept

Much effort was directed to basic principles, conceptual design and testing of our hypotheses (sometimes in the reverse order).

One significant outcome of all this effort was the discovery of the so-called "shear-friction hypothesis." Using this

concept, a simple formula can be deduced for finding the reinforcement for ultimate shear across any potential crack plane.

The shear-friction concept is very useful in proportioning the reinforcement for corbels, dapped beams and many other types of precast concrete connec-

tions. It is recognized in the ACI Building Code and is applied extensively in the *PCI Design Handbook*.

How we stumbled upon the shear-friction concept might be of some interest. In the late fifties I conducted some shear tests using push-off specimens with the aim of finding suitable amounts of reinforcement for precast connections.²²

After I plotted the test data, Halvard Birkeland analyzed the curves and formulated a simple linear relationship to represent the data.²⁵ He coined the phrase "shear-friction" because the concept develops shear by friction rather than by bond.

Birkeland presented his ideas at various ACI and PCI Conventions but the audience was not very receptive. It was not until Robert Mast published his ASCE paper in 1968²⁶ that engineers accepted the usefulness of the shear-friction concept.*

In the next issue, I will conclude my adventures in prestressed concrete with highlights of production developments and descriptions of the most interesting prestressed structures we engineered and produced.

*The basic premise in applying the shear-friction concept is that by placing reinforcement across the anticipated crack or failure plane, shear resistance capability is produced at the crack interface. Under ultimate conditions, the reinforcement develops a tensile force equal to $A_s f_y$, where A_s is the area of the non-prestressed steel reinforcement crossing the interface and f_y is the specified yield strength of the steel.

The component of the steel force normal to the crack interface produces an equal compressive force on the concrete, which, in conjunction with friction analogy, results in shear resistance at the interface.

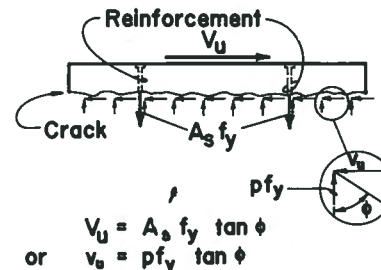

References

16. Gannett, J. K., and Waidelich, A. T., "Prestressed Concrete in Buildings" (Parts 1 and 2), Proceedings, First United States Conference on Prestressed Concrete, Massachusetts Institute of Technology, Cambridge, Massachusetts, August 14-16, 1951, pp. 67-75.
17. Anderson, Arthur R., and Waidelich, A. T., "Prestressed and Precast Concrete Buildings at Boeing Plant," *ACI Journal*, Proceedings V. 58, No. 1, July 1961, pp. 41-58.
18. "Tacoma Plant Features Factory Prestressing," *Concrete* September 1953, 4 pp.
19. MacPherson, A. R., "Applying Mass Production to Prestressed Structural Concrete," *Concrete Products*, December 1953, pp. 173-175.
20. "Precast Units Frame Building," *Construction Methods and Equipment*, March, 1955, pp. 162-163.
21. "Carport—P/A Selected Detail," *Progressive Architecture*, December, 1957, p. 126.
22. Anderson, Arthur R., "Composite Construction in Precast and Cast-in-Place Concrete," *Civil Engineering*, March 1960, pp. 34-37.
23. Anderson, Arthur R., "Composite Designs in Precast and Cast-in-Place Concrete," *Progressive Architecture*, September 1960, pp. 172-179.
24. Anderson, Arthur R., "Design of Joints and Connections in Precast and Prestressed Concrete Structures," *Proceedings, Western Conferences on Prestressed Concrete Buildings*, Los Angeles and San Francisco, November 1960, pp. 127-149.
25. Birkeland, Philip W., and Birkeland, Halvard W., "Connections in Precast Concrete Construction," *ACI Journal*, Proceedings V. 63, March 1966, pp. 345-368.
26. Mast, Robert F., "Auxiliary Reinforcement in Concrete Construction," *Journal of the Structural Division*, ASCE, V. 94, No. ST6, June 1968, pp. 1485-1504.

* * *

NOTE: Article continues in Part 7 (cont.), p. 238.

An Adventure in Prestressed Concrete



Arthur R. Anderson
Concrete Technology Corporation
Tacoma, Washington

The whole of science is nothing more than the refinement of everyday thinking.
Albert Einstein

In the last issue of the PCI JOURNAL, I recounted how, with the experience gained on the Walnut Lane Bridge and at the Austin Company tests, I returned to Tacoma, Washington to set up Concrete Engineering Company with my brother Tom and father Eivind.

Construction of our pilot plant and an outdoor pretensioning bed were quickly followed by development of a high-strength "no-slump" concrete, with compressive strengths up to 10,000 psi (69 MPa).

After a slow start, which showed us the importance of effectively marketing our products, we reorganized into two companies: Concrete Technology Corporation, confined to production, testing, and de-

velopmental research, and Anderson and Anderson, now ABAM Engineers, Inc., operating as an independent consulting engineering firm.

We developed several innovations which helped us produce a more economical or higher quality product. With these, and with some imaginative engineering, we produced a number of unique or interesting structures. The most outstanding of these, and the systems they used, are described here.

Developments and Applications

The following section highlights some of the developments and the more interesting precast prestressed structures

Continuing from the previous issue, the author concludes his adventures in prestressed concrete with highlights of production developments and descriptions of the most interesting prestressed structures his companies engineered and produced.

we designed and built during the fifties and sixties.

Anderson Post-Tensioning System

With the advent of seven-wire stress-relieved strand, we saw a need to develop a post-tensioning system for our pretensioned products. (It might be mentioned that several European post-tensioning systems, using smooth wires and bars, were being actively promoted in the United States.)

To this end, in 1953 I devised the "Anderson Post-Tensioning System" (which was later patented in 1962).

The Anderson anchorage system (Figs. 60 and 61) consisted of a forged steel socket and a fluted plug, which wedges in the core of the tendon and seats each strand. By using the larger diameter seven-wire strand, the Anderson system could take advantage of the reduction in installation costs resulting from fewer tendons needed. The 16-in. (406 mm) stroke hydraulic jacks had 12 slot stressing rings, allowing a variety of strand stressing patterns, and not requiring the strands to be threaded through the jack.

This post-tensioning system enabled us to win our first segmentally precast, post-tensioned I-beam project in 1954 with the Klickitat county bridge. The system was also used successfully on the Seattle City monorail, Cheney Baseball stadium, and the Walt Disney

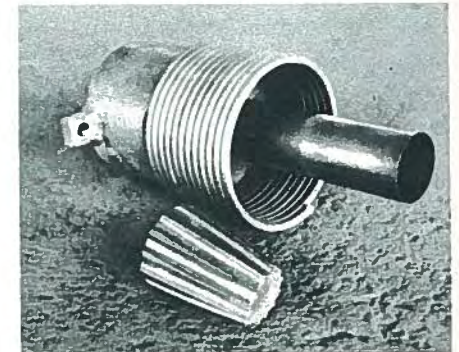

Fig. 60. Forged steel socket and fluted aluminum plug. The relatively soft aluminum plug deforms during stressing and becomes "keyed" to the wire tendons. Since the wires themselves do not deform, there is little tendency to weaken the wires at the grip.

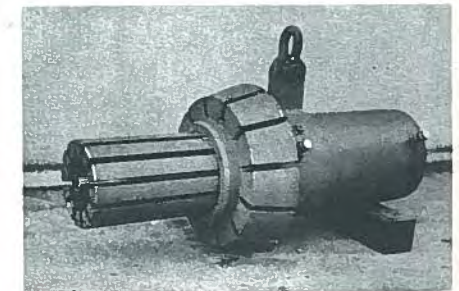

Fig. 61. Anderson system jack. Note the slots in the strand ring, allowing easy placement of tendons in a variety of strand patterns.

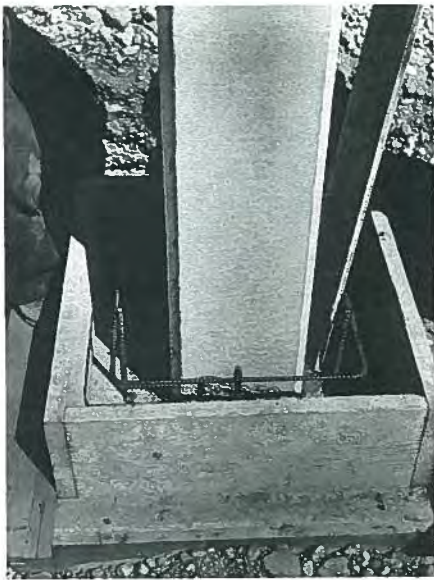

Fig. 62. Precast concrete column is spotted neatly on footing inside reinforcing steel, then concrete is cast around the base (Tacoma City Light shop building).

World monorail. (These projects are described later on in this article.)

Tacoma City Light Shop Building

Our first successful alternate design competition for a building was in 1953. This was for an industrial building for the Tacoma City Light Department—an ideal opportunity to supply our standard beams and channel slabs. The 600 x 120-ft (183 x 37 m) shop building was to have cast-in-place column footings and exterior wall columns and beams; all other columns, beams and girders, and roof slabs were to be precast.

We decided to test a prototype beam with a 4-in. (102 mm) web to 1.2 times dead load plus 2.4 live load. The beam, designated IB 15/32, was tested with complete success.

When the column footings had been cast, with the base plate set accurately to grade, the precast columns were set and aligned, then concrete cast around the base (Figs. 62 and 63). The preten-

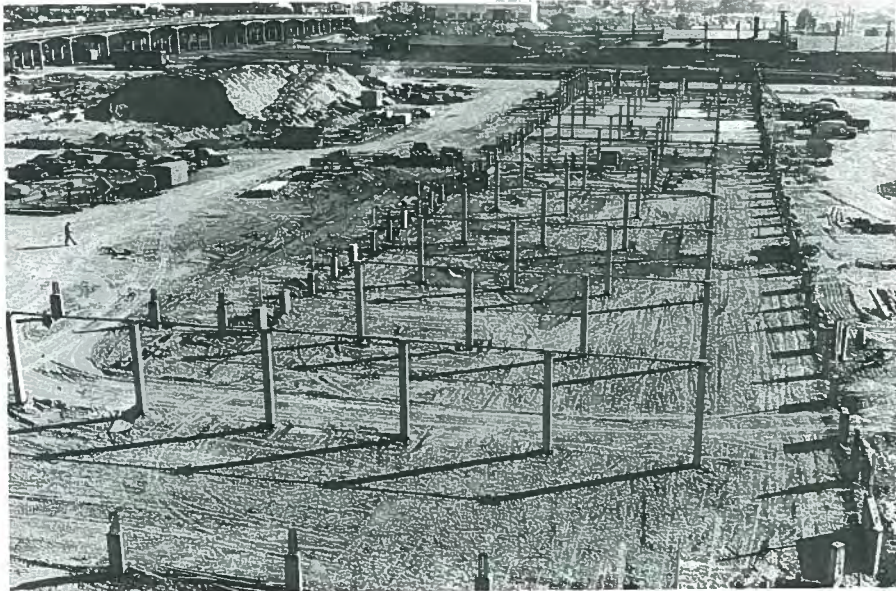

Fig. 63. Aligned columns, all in place, await setting of girders. Outer wall footing piers are ready for column forms.

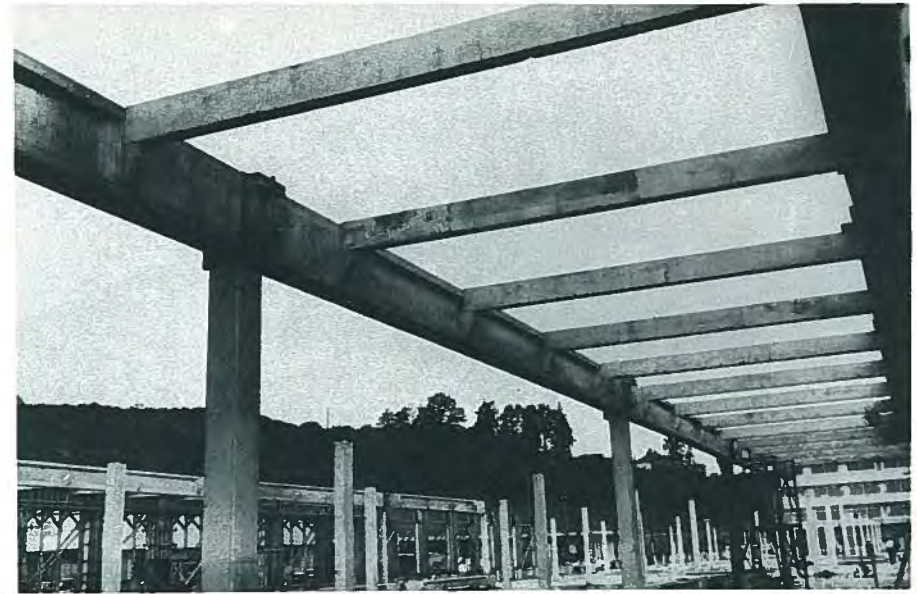

Fig. 64. Following girder erection 5 x 12-in. (128 x 305 mm) prestressed beams were set in the girder corbels and tied-in to stiffen the frame.

sioned girders were erected with a long spreader bar, then smaller beams were set on the girder corbels and tied in, to stiffen the frame (Fig. 64).

The girder corbels had pipe sleeves cast into them to facilitate installation of electrical conduits in the completed structure. The roof panels, lightweight

precast concrete, were hoisted to the roof two at a time, then lowered into place (Fig. 65).

Alternate Designs

Many Concrete Technology projects were won using the basic designs or alternate schemes prepared by ABAM



Fig. 65. Lightweight roof slabs are lowered, two at a time, into place across the structural frame. The precast slabs are 40 in. (1.02 m) wide, 10 ft (3.05 m) long and 1½ in. (38.1 mm) thick, with a 6-in. (152 mm) leg.

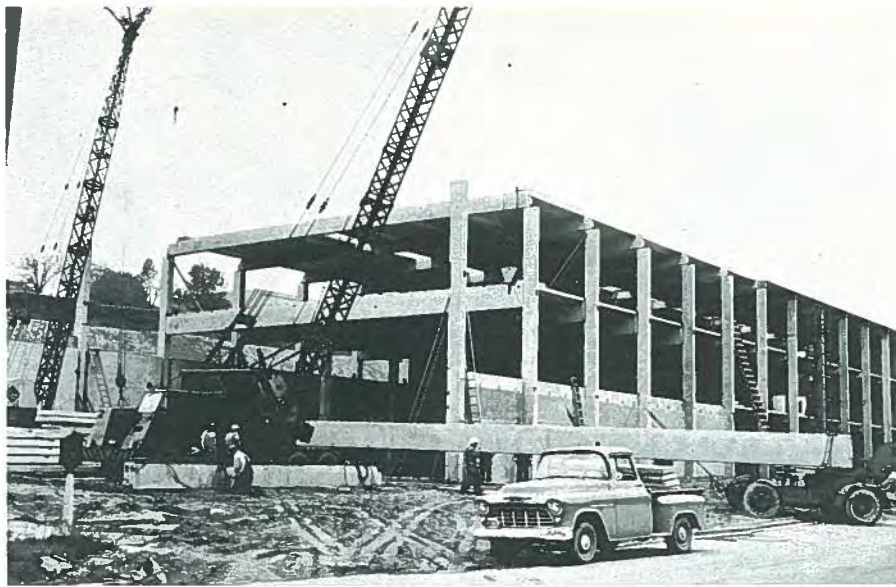

Fig. 66. Erection proceeds on totally precast three-story school in Tacoma.

Engineers, Inc. These include a three-story school building (Figs. 66 and 67), Cheney Stadium in Tacoma (Fig. 68) and a 4-mile subaqueous sewer interceptor.

The school, erected in Tacoma in 1956, had column-to-beam connections designed for moment resisting frame ac-

tion (Fig. 66). The three-story school was ready for occupancy in only 6 months (Fig. 67).

Concrete Technology won the design-construction competition for the Tacoma baseball stadium in 1960. Cheney Stadium was built from 1650 precast concrete elements, assembled



Fig. 67. Completed school, after only 6 months of construction.



Fig. 68. Cheney Stadium in Tacoma, completed in 3½ months, did much to publicize the usefulness of prestressed concrete.

and post-tensioned together in 3½ months.

A free cantilever eliminated all columns, providing an unobstructed view from any seat. Roof beams were post-tensioned through the exterior columns to form an efficient, functional structural system (Fig. 68).

This project did more to publicize prestressed concrete in Tacoma than all previous projects combined.

Norton Building

Our Tacoma pilot plant was both a production and a testing facility. In many cases, as with the Norton Building beam design in 1957, it was necessary to convince clients of a design's suitability through structural testing.

The Norton Building beams were unusual because of a series of nine holes through the 6-in. (152 mm) web, of vari-



Fig. 69. Load test of beam with nine web openings for Norton Building at Concrete Technology pilot plant.



Fig. 70. The Norton Building.

ous shapes and sizes, which allowed wiring, plumbing and heating ducts to pass through the beams at right angles (Fig. 69).

The prototype beam was cast in December, 1957. Its design load was 30 tons (27 t); at 67 tons (60 t), the first cracks began to appear in the bottom flange. Cracks continued to develop with increasing load until, at 135 tons (122 t) and a deflection of 9 in. (229 mm), cracks were visible halfway up to the web. However, when the load was removed, the cracks disappeared. Test over; the prototype was approved.

Concrete Technology Corporation manufactured 238 of the modified I-beams, which formed the floor support for the upper 17 stories of the 21-story Norton Building (Fig. 70). The use of prestressed concrete beams in this building marked the first time pre-

stressed concrete had been used in the United States in a building higher than six stories.

A typical floor in the building is 210 x 70 ft (64.0 x 21.35 m), three 70 ft (21.35 m) bays long and one wide. The beams are 37 in. (940 mm) deep with 20-in. (51 mm) flanges and have lengths of 69 ft 3 in., 69 ft 9 in., and 69 ft 11 in. (21.12, 21.27, and 21.32 m).

Both $\frac{5}{16}$ and $\frac{3}{8}$ in. (7.9 and 9.5 mm) 7-wire strand were used in the beams: 24 lengths of $\frac{3}{8}$ -in. strand were pretensioned to 70 percent of the ultimate 175,000 lbs (778.4 kN) in the base flange, and 24 of the $\frac{5}{16}$ -in. strand, 12 in each of two draped tendons, were post-tensioned after the beams had been stockpiled in the yard. Each beam weighed 15 tons (13.6 t) and the concrete had ultimate strength of 9000 psi (61.1 MPa).

Highway Bridges

In addition to buildings, we were also trying to develop a market for prestressed concrete bridges. Our best market in the early fifties was the replacement of obsolete timber bridges, mainly used on remote county roads. Although the wood superstructures were often deteriorated, the existing piers and abutments were usually intact.

In the development of in-house bridge standards, we analyzed the cost of several sections (see Fig. 71). We produced both I and T sections using both normal weight and lightweight concrete.

Concrete Technology also developed, in 1959, a bulb T cross section which combined pretensioning and post-tensioning. This allowed re-arrangement of the tendons to produce a highly efficient section that maximized tendon eccentricity, as shown in Fig. 72, which compares cross sections and prestressing steel arrangements in the bulb T and standard AASHTO beam sections.

Fig. 56 (see last issue) showed section properties of the I-beams we produced; Fig. 73 a and b show a standard

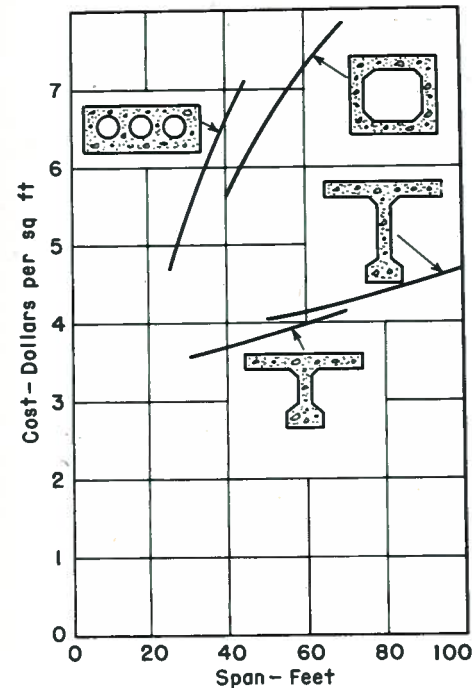

Fig. 71. Cost-span comparison of various bridge sections.

decked bulb T bridge section and cost information for lightweight T-sections. Design properties of the bulb T-section are given in Fig. 74.

Of particular significance was the development of the decked bulb T-girder. Incorporating the finished deck as part of the T-section, the shape was especially useful in remote and rugged sites.

County officials and contractors liked these sections especially in alternate design competitions.

However, not everybody agreed with the slenderness of our sections. Several prominent engineers were especially critical of the thin sections.* They were especially concerned about the thin sec-

*Anderson, Arthur R., "How Beam Design Affects Prestressed Concrete Bridge Costs," *Engineering-News Record*, October 17, 1957, pp. 326-328. See also Reader Comment, "CTC Beams Are Too Thin," in the December 5, 1957 issue of *Engineering-News Record*, pp.12-15.

tions (which contrasted noticeably with the stubbier and heavier AASHTO-PCI standard beams), the chance of under-flange cracking and the special measures that might be needed during transportation and erection.

In defense, we should say that our production methods, in which we used high strength no-slump concrete with both internal and external vibration, overcame most of these objections. Our experience over the last 25 years has shown that these bridges have withstood the test of time and are still being used successfully.

The adoption of the AASHTO standard beam series for girders for highway bridges was a major forward thrust for

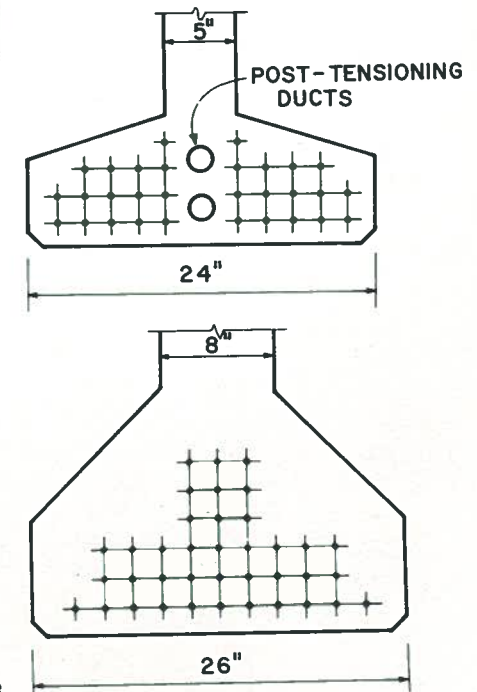
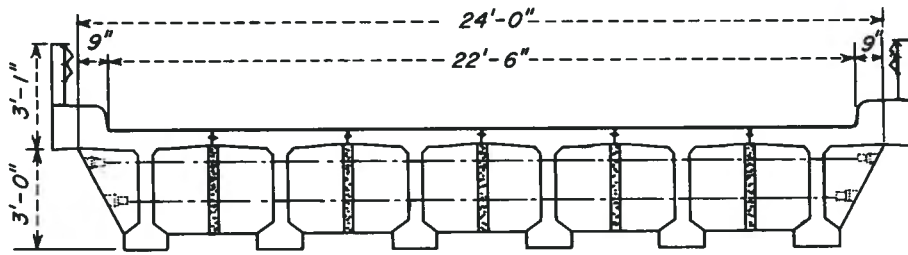
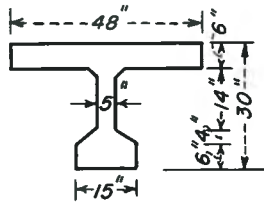

Fig. 72. Top drawing shows that by using post-tensioning tendons and re-arranging the strand, a more efficient section (with a better utilization of prestressing) results as compared to the bulkier AASHTO section shown below.



BRIDGE SECTION

Fig. 73a. Section of a CEC standard decked bulb-T bridge used extensively for county and forest roads.



COST OF LIGHTWEIGHT T-SECTIONS - TB 48/32

Span ft	Cu yd concrete per sq ft	Lb Reinf. steel per sq ft	Feet of $\frac{3}{8}$ in. strand per sq ft	Cost - \$ per sq ft			Total
				Concrete	Bars	Strand	
30	0.032	3.0	2.25	2.88	0.45	0.23	3.56
40	0.032	3.0	3.50	2.88	0.45	0.35	3.68
50	0.032	3.0	5.0	2.88	0.45	0.50	3.83
60	0.032	3.0	6.5	2.88	0.45	0.65	3.98
70	0.032	3.0	8.25	2.88	0.45	0.83	4.16

Fig. 73b. Cost information for lightweight decked bulb-T sections (TB 48/32).

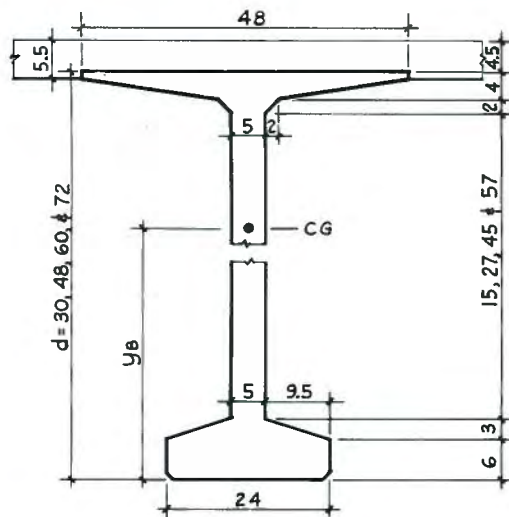

Depth d, in	Area in ²	Y_b in	Moment of inertia in ⁴
24	380	12.14	28,900
30	410	14.95	51,100
36	440	17.78	80,700
48	500	23.51	164,000
60	560	29.29	283,200
72	620	35.12	442,800

Fig. 74. Design properties of bulb T-section, used with cast-in-place deck slab.

WASHINGTON

BEAM PROPERTIES			
TYPE	AREA IN ²	Y_b IN.	MOMENT OF INERTIA-IN ⁴
40	253	15.16	31,000
60	332	18.63	70,100
80	476	22.53	154,900
100	546	27.90	249,000
120	626	35.60	456,000

STATE STANDARD BRIDGE BEAMS

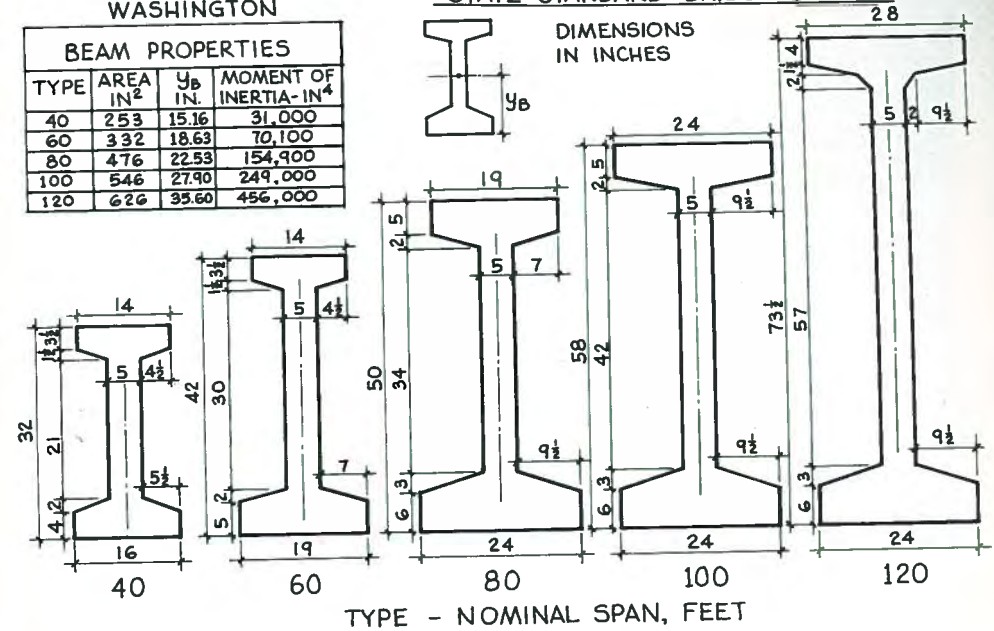

TYPE - NOMINAL SPAN, FEET

Fig. 75. Washington State standard beams.



Fig. 76. Formwork for Klickitat County bridge girder showing rubber extractable cores and reinforcing in place prior to casting. Note dividers to separate beam into three segments.

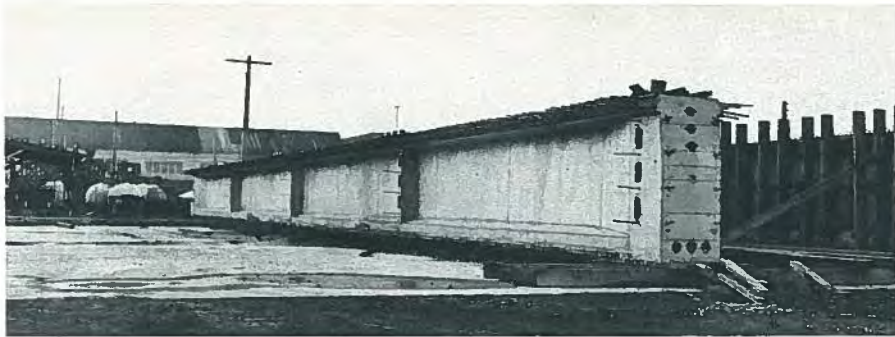

Fig. 77. Completed girder after stripping side forms.

factory-produced pretensioned beams. At this time, the sections were carefully evaluated by the State of Washington Bridge Department. Because of their economy, our I-sections were adopted, opening a substantial new market for us (see Fig. 75).

Klickitat County Bridge

When the Klickitat County Bridge at Goldendale, Washington (made more

famous this year by the solar eclipse) was built in 1954, the contractor discovered that 90-ft (27.5 m) girders were too heavy to haul on the highway, and too big to handle with his cranes—a 20-ton (18.1 t) crane was a large crane at that time.

Our solution was to cast the 90-ft (27.5 m) girders with divider plates at the third points of the girders, as shown in Fig. 76. The ducts for tendons were



Fig. 78. Girder sections being erected on falsework at site.

formed by rubber cores, also visible in Fig. 76, which were removed within 12 hours of casting (Fig. 77).

The divider plates allowed the girders to be split into three 30-ft (9.2 m) sections with little trouble, thus allowing delivery and subsequent placement of the girders on falsework (Figs. 78). After placement, prestressing tendons were threaded through the tendon ducts, and the three sections of each girder were post-tensioned together again using the Anderson Post Tensioning System (Fig. 79).

Deck Bulb-T

The deck bulb-T was also used advantageously for grade separations and sites with severe vertical clearance requirements (Figs. 80 and 81).

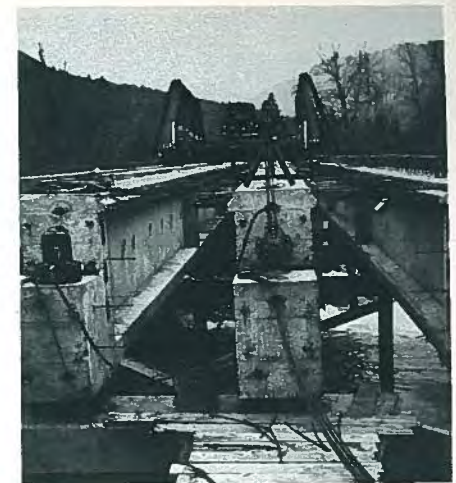

Fig. 79. Anderson post-tensioning system jack in position on Klickitat County bridge girder.

Fig. 80. The deck bulb-T being used advantageously at a remote mountainous site. Over the years, this section has found extensive use in the rugged northwest.



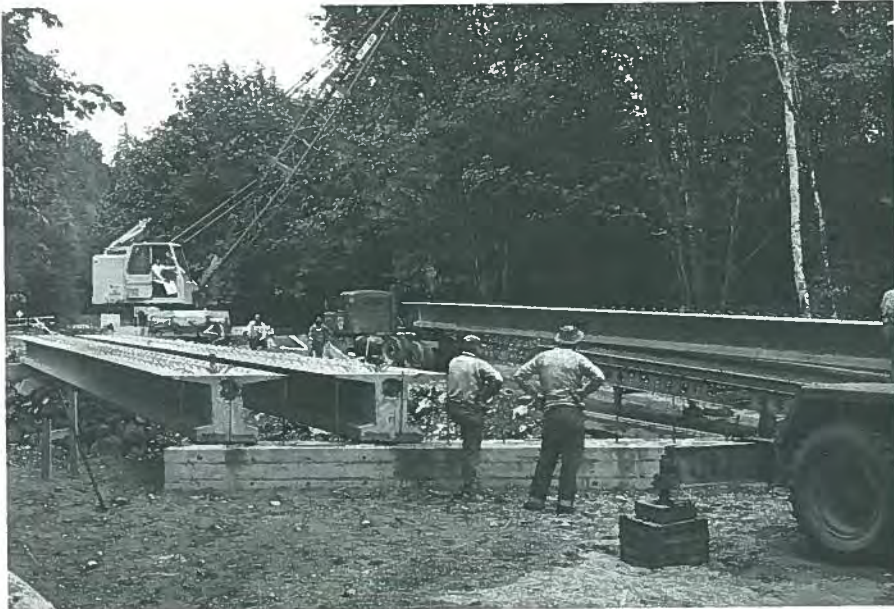

Fig. 81. Bulb T-beams being placed at erection site.

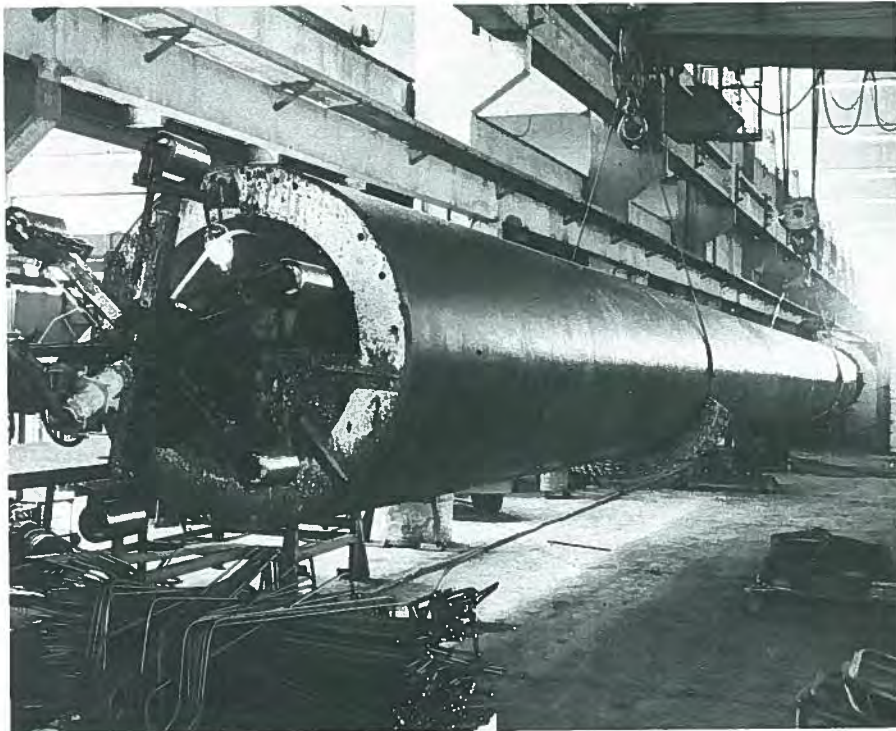

Fig. 82. Mandrel for casting monolithic prestressed hollow cylinder piles.

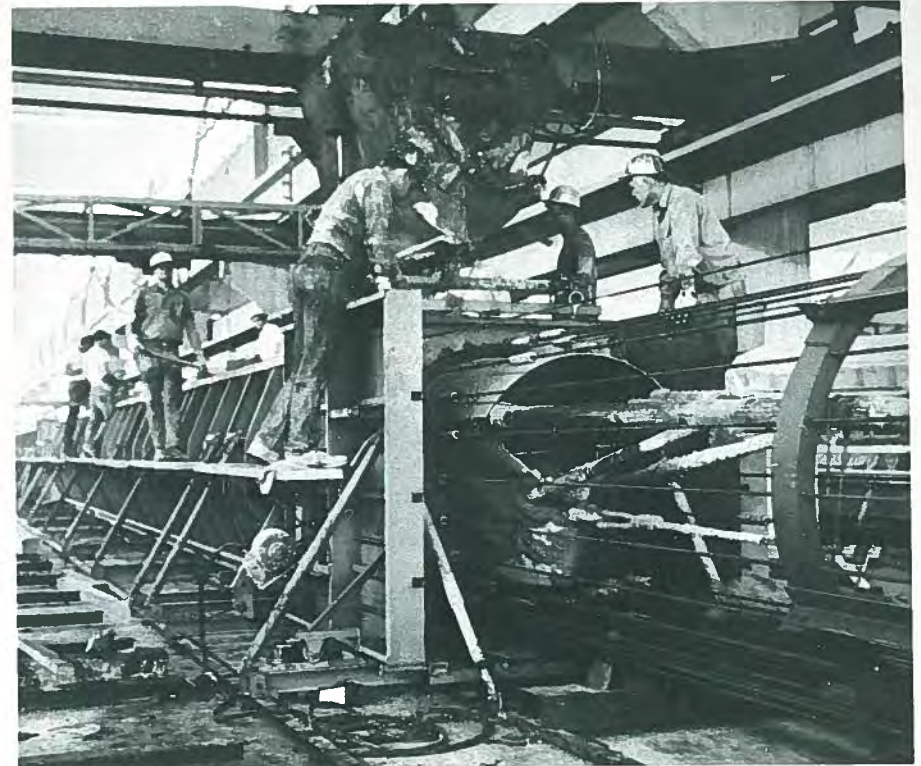

Fig. 83. Formwork and reinforcing cage for casting prestressed cylinder piles.

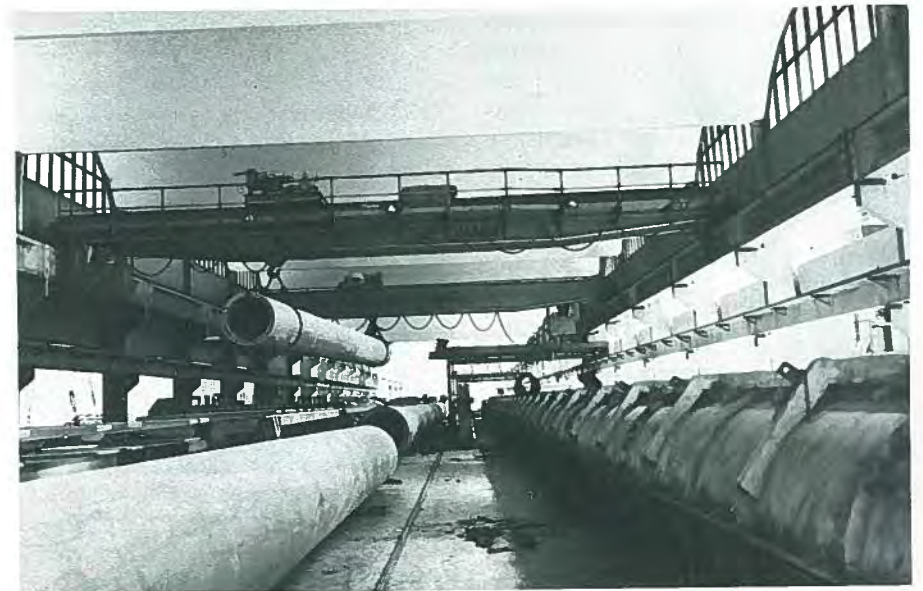

Fig. 84. Freshly cast prestressed hollow cylinder piles.

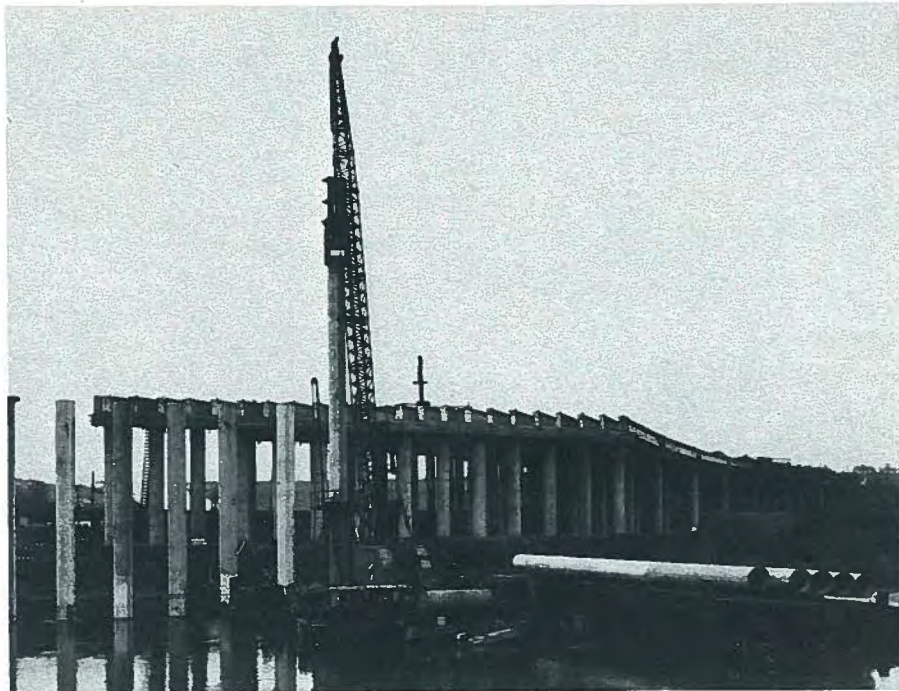

Fig. 85. Prestensioned monolithic hollow piles for Evergreen Point Bridge project (1962).

Prestressed Hollow-Cylinder Piles

One of the more interesting production techniques we devised in the late fifties was the development of a continuously moving inner form for casting long prestensioned hollow cylinder piles and hollow box beam sections (see Figs. 82-84). Prior to this time, Raymond International had used a segmental post-tensioned approach to produce such piles.

An opportunity to apply our technique occurred in 1957 in connection with the construction of the 11th Street Bridge in Tacoma. For this project, we supplied monolithic prestressed hollow cylinder piles up to 90 ft (27.5 m) long. These types of piles also proved to be useful on many subsequent jobs (see Fig. 85).

Interceptor Sewer

A later development occurred in 1965 using very long, large diameter preten-

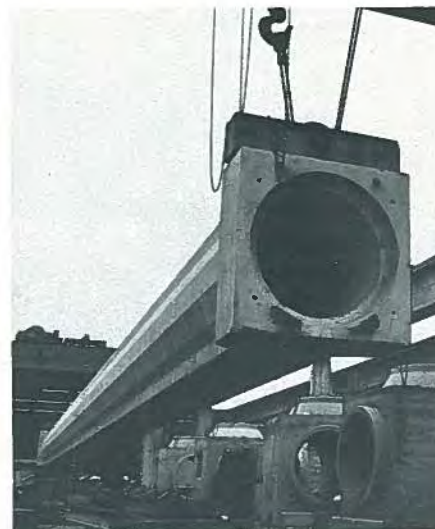

Fig. 86. 16-sided precast prestressed hollow pipe section 120 ft (36.6 m) long and weighing 85 tons (77 t) being lifted at plant for Lake Washington interceptor sewer.

sioned monolithic piles. This was in connection with the Lake Washington subaqueous sewer project. The original design used a 120-ton (109 t) square section. However, with our alternate design we were able to come up with a 16-sided configuration that reduced the weight of the section to 85 tons (77 t).

The new section, which was 120 ft (36.6 m) long, had a 4-ft (1.2 m) inside diameter and roughly a 5-ft (1.5 m) outside diameter (see Fig. 86). Altogether, 229 sections of pipe (with precast pile caps) were used covering 4.65 miles (7.48 km) in Lake Washington (see Fig. 87). The sections, which were supported on piles, using precast pile caps, were 12 to 27 ft (3.7 to 8.2 m) below the water level.

A further development was the introduction of prestressed concrete for harbor works, using very long slender piles and prestressed deck panels capable of carrying 90-ton (81.6 t) axle loads.

For very long prestressed piles we developed the so-called Anderson splice. This splice, which employs a steel sleeve to fit tightly around the pile, has been used extensively in the state of Hawaii.

Seattle Monorail

The Seattle Monorail (Fig. 88) was built in 1961 for the Seattle World's Fair. The twin track is one mile long and uses 150 girders, but the real significance of this project is that the guide beams are curved prestressed girders—a development which required highly sophisticated engineering and manufacturing techniques.

Walt Disney World Monorail

The Walt Disney World Monorail (Fig. 89) is installed at Walt Disney World in Orlando, Florida. The guideway is elevated with the exception of a very small amount of guideway placed at-grade in the station areas.

The elevated beam is a rectangular hollow precast prestressed concrete



Fig. 87. 85-ton (77 t) precast prestressed hollow pipe section being installed in Lake Washington.



Fig. 88 View of the Seattle Monorail under construction, showing the cross section of the girders, and the shape of the support columns, on a straight stretch of the beamway.

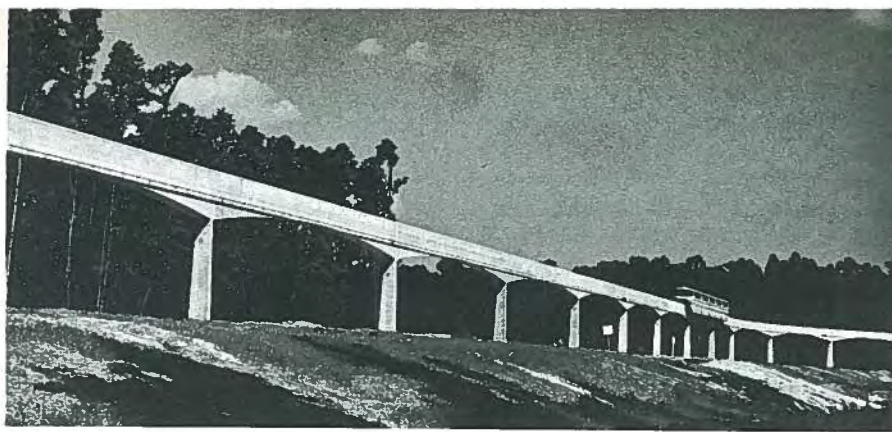

Fig. 89. The Walt Disney World monorail guideway, near Orlando, Florida, is elevated except for a few sections placed at-grade in the station areas.

box. The section is haunched at the supports to facilitate easier field post-tensioning. A typical beamway section consists of six prestressed concrete beams, post-tensioned for continuity over six spans. The guideway consists of straight and horizontally and vertically curved beams, averaging between 90 and 100 ft (27.5 and 30.5 m) long.

Longitudinal forces are removed by an oversized column placed at the center of each continuous segment. Expansion motions from the thermal forces are removed at a double column at the end of each continuous section.

Fig. 90 shows the adjustable curved forms used to cast the guideway girders.

Bradley Field Guideway

The Fairlane Town Center, Dearborn, Michigan guideway was entirely elevated. Its sister guideway at Bradley Field in Hartford, Connecticut (Fig. 91) is elevated but also contains some at-grade segments. The at-grade section consists of a continuously reinforced concrete slab with cast-in-place parapet walls. The parapet walls are nominally the same size as the elevated guideway parapet walls.

The elevated structure consists of precast prestressed concrete beams in the form of a channel. The channel is 11

ft 8 in. wide and 26 in. deep (3.6 x 0.66 m). The precast beams rest on elastomeric sliding bearings on the column tops. Individual beams are post-tensioned together to form four to six span continuous sections.

Longitudinal forces are removed into the column by fixed pins within the elastomeric bearings. A 2-in. (5 mm) topping and a steel faced steering rail is placed at the beam after post-tensioning is completed.

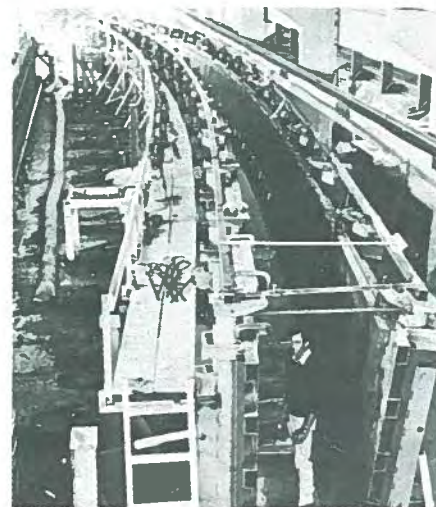

Fig. 90. Forms for Disney World curved guideway girders.



Fig. 91. View of completed Bradley Field guideway, Hartford, Connecticut.

Closing Remarks

The progress and improvement of efficiency and economy of prestressed concrete construction during the past 25 years was substantial, but not as dramatic as in other fields of technology. When I compare the developments in our industry and others over the last 60 years of my involvement with concrete, the changes in the others are indeed striking:

- Transportation changed from horse-drawn vehicles to the automobile, from wind-propelled ships to high-speed, turbine-powered ocean liners, and from the first tentative flights to supersonic jet aircraft.
- Medical science overcame polio, smallpox and tuberculosis.
- Electronic computers added enormous leverage to man's mental capacity, enabling him to produce, propel and communicate with vehicles in outer space.

If prestressed concrete is to make such a quantum jump, we must first discover incentives which will reward innovation and provide financial support for research and development.

A major obstacle to technological advancements in concrete is the fragmentation of the construction industry, where responsibility is diffused among clients, architects, engineers, contractors, and material suppliers.

In most cases, the contractor is not known to the designers until the contract is awarded (generally to the lowest bidder). During construction, disputes can frequently arise, and often the final settlement is determined by the judgment of a court of law. Thus, many construction projects are profitable only to attorneys. Under these conditions of practice, there is little incentive to provide funds for research and development.

Industry practice for design and construction is governed by codes and recommendations formulated by committees. The data base is assembled from numerous sources, reflecting widely varying practice and performance. Codes that are published as industry standards, therefore, are based on the "lower bound," and reflect the lowest performance. Few incentives exist to encourage, recognize or reward the engineer and builder who strives for the "upper bound."

In the aircraft industry, design, engineering, research and development, and manufacturing are coordinated and managed by an integrated organization. Perhaps this is an approach that would also help the prestressed concrete industry.

The energy crisis and its impact on construction costs may well direct more attention to the construction possibilities of high performance, high-quality prestressed concrete. We should be prepared to make the most of this opportunity.



Part 8—
The Beginnings of
Prestressed Concrete
in Canada

by
Mark W. Huggins

The Beginnings of Prestressed Concrete in Canada



Mark W. Huggins
Professor of Civil Engineering
Department of Civil Engineering
University of Toronto;
Director, Morrison, Hershfield,
Burgess & Huggins, Limited
Consulting Engineers

"The author considers himself entitled to state that he has succeeded in creating a theory and the means of giving it practical application which class the combination of steel and concrete when treated in accordance with these new methods as an entirely new material possessing properties very different from those of ordinary reinforced concrete."

*Eugene Freyssinet
Concrete and Constructional
Engineering, London, April 1936*

This startling quotation (alluding to the discovery of an "entirely new material") appears in a paper au-

thored by the late French pioneer Eugene Freyssinet in a British publication in 1936.

Freyssinet, who is generally regarded as the father of prestressed concrete, had carried out an experiment in 1926 during the construction of the great Plougastel concrete arch bridge. In a gap left at the crown of the arch, he had installed a set of jacks by means of which he controlled the location of the line of thrust during the first year after casting.

In 1927, as a direct consequence of his observations on the behavior of this arch and his previous studies,

The author traces the important events that shaped the beginnings of prestressed concrete in Canada. He describes the early significant bridges and buildings, the major developments, and especially the people that pioneered the precast and prestressed industry.

Freyssinet concluded that the idea of prestressed concrete could be made into a practical reality if high tensile steel were used in combination with high strength concrete. During the next decade (prior to World War II), Freyssinet applied his prestressing ideas in the manufacture of pipes and poles and in the construction of bridges, dams, harbor works and many other diverse types of structures.

Word of Freyssinet's concept of prestressed concrete, together with its applications and potential, gradually did reach the world outside of France.

* * *

In the early thirties I had the good fortune to become employed as an engineer with the late Eric P. Muntz in Dundas, Ontario. Muntz was a very ingenious engineering contractor who quickly recognized that this new construction material, prestressed concrete, had a great future in civil engineering structures. At the time we were in the depth of the great depression and there was more free time available than might have been wished. This gave us an opportunity to experiment with many of the

novel ideas which Muntz's brain was generating.

One of his most interesting, and eventually successful, areas of development involved reducing the cost of formwork for cast-in-place reinforced concrete. From this, he became interested in the use of cold drawn high carbon steel wire for form ties and, as a direct result, in methods of anchoring such wires. He took out patents on a number of gripping devices; in fact, one of these devices proved to be very successful and has been widely used in Canada.

Among the anchorages Muntz developed was the simple dead end, produced by putting a head on the end of a wire. In 1934 or 1935, a spike-heading machine at the Burlington Steel Company in Hamilton, Ontario, was used to put some heads on high tensile steel wires of 0.25 and 0.33 in. (6.4 and 8.4 mm) diameter. In tests I conducted, we established that practically 100 percent of the wire's tensile capacity could be developed in this way. This anchorage system was later published in a brochure advertising Muntz's various types of form hardware.

His success in working with high tensile steel and the obvious potential of Freyssinet's contribution to prestressed concrete led Muntz to fabricate an experimental rectangular post-tensioned

The Author

Mark W. Huggins took his undergraduate and graduate training at the University of Toronto, where he developed an early interest in the work of Eugene Freyssinet. Upon graduation, he joined the firm of E. P. Muntz, Engineering Contractors, an association which greatly influenced his future interest in prestressed concrete.

In 1938, at Queen's University, this Muntz experience resulted in the introduction of some prestressed concrete in the first course on concrete which he taught. As a professor at Toronto, he was a member of the organizing committee for, and presented a paper at, the Canadian Conference on Prestressed Concrete in 1954.

In 1946, he became a partner in Morrison, Hershfield, Millman & Huggins, Consulting Engineers. In this capacity, in 1952, he participated in the design of prestressed concrete roof joists for the Hydro Electric Power Commission of Ontario. At the same time he, jointly with E. P. Muntz, produced a prestressed concrete runway design. Since then, he has designed several prestressed concrete bridges and reported on many prestressed concrete structures.

Professor Huggins was chairman of the committee responsible for the first Canadian Standard for the Design of Prestressed Concrete. He was also coauthor with L. G. Cazaly, in 1962, of the Canadian Prestressed Concrete Institute Handbook, the first in North America. He was a founding director of the Canadian Precast Concrete Bureau which has since become a CSA Plant Certification Committee.

beam about 10 ft (3.05 m) in length. The beam was transported by car trailer approximately 50 miles (80.5 km) to the testing laboratory of the Department of Civil Engineering at the University of Toronto.

Unfortunately, the back of the beam was cracked in transit. Nevertheless, despite this accident, the beam was loaded to failure and behaved in a manner consistent with what might have been expected from an uncracked prestressed beam.

In the late thirties contracting work interrupted the research program. Except for some successful work in producing high strength concrete using techniques similar to Freyssinet's, and a proposal to the City of Hamilton to build some prestressed concrete poles (which was accepted), the research was terminated.

However, Eric Muntz had not lost his interest in the use of prestressing. During World War II, when he was presented with the problem of reinforcing timber trusses which had been used in the design of "temporary" hangars and drill halls for the Canadian armed forces, he immediately decided that prestressing was the answer. He realized that high tensile wire and the anchorage which he had developed for his form hardware were the ideal materials.

This process of prestressing was used successfully from coast to coast, on thousands of such single 112-ft (34.1 m) span trusses as well as on twin hangars, where two 112-ft (34.1 m) trusses were made continuous. Many of these "temporary" structures are still in use today.

On June 16, 1950, Muntz was retained by the Canadian Commercial Corporation to "prepare a report on, and design an experimental prestressed concrete slab." The report and design were completed (at the time I worked as a consultant to Muntz) in early 1951, and approval was granted for building an experimental prestressed slab at the

Trenton, Ontario base of the Royal Canadian Air Force.

Once again, unfortunately, pressure of other business activity prevented the execution of this project. The work involved a novel method of prestressing slabs which had never been used before. Economic calculations, however, indicated that such slabs would not prove competitive in most locations.

By this time (early fifties), Professor Gustave Magnel had completed his lecture tours in the United States and Canada, and the famous Walnut Lane Bridge had been built using the Magnel system in Philadelphia. Of equal importance, Magnel's book on *Prestressed Concrete* had stirred considerable interest in North America on the potential of prestressed concrete. His was the first book to present the design of prestressed concrete as a simple procedure which could be easily understood by any engineer versed in the design of structures.

By 1951, one of Magnel's disciples, the late Phillip Benn, had arrived in Eastern Canada and become the vice president and general manager of the Precompressed Concrete Company Ltd. (PRECO); a firm established with the financial backing of Franki Canada Ltd. This firm was the first of the many companies which were about to establish the prestressed concrete industry in Canada.

There were many difficulties ahead, including the reluctance of building authorities to accept this new form of construction without codes against which they might judge it, as well as the reluctance of many consulting engineers to design with a material about which they knew little and the contractors, possibly less.

In British Columbia, prestressed concrete use began with the design and construction of a 16-ft (4.9 m) long experimental beam which was tested to destruction at the University of British Columbia. The beam was made up of

hollow blocks of a type widely used in Europe. According to Keith Douglas, managing director of Prestressed Concrete Engineering Ltd. in Vancouver, the beam test proved to be completely satisfactory.

In November of 1951, this firm built a full-scale post-tensioned beam which was tested satisfactorily, leading to the acceptance of the design and its use in the 59-ft (18 m) span roof beams of a laundry building.

The Department of Public Works of British Columbia approached Prestressed Concrete Engineering Ltd. in 1952, with a view to designing a test beam for a bridge. A. van den Brandeler, who had previous design experience in prestressed concrete in Paris, France, was called in to design the beam. The specifications for the beam were prepared by the Department of Public Works. If the test justified it, similar beams were to be used in a 60-ft (18.3 m) span bridge, longitudinally and transversely post-tensioned using the Magnel system.

The test was conducted under the direction of R. W. Klick of the British Columbia Research Council. The beam was loaded rapidly five times, to three times the design live load; in no case was there any permanent deflection. It eventually failed at 5½ times the live load.

The results of this test led to the construction, in 1952, of the first prestressed concrete bridge in Canada, across Mosquito Creek in North Vancouver. A. B. Sanderson, assistant bridge engineer for the Department of Public Works, reported to a meeting of the Engineering Institute of Canada that bridge builders across Canada had watched this pioneering effort with great interest, and that the bridge "proved not only economical, but satisfactory from a structural point of view."

Prestressed Concrete Engineering Ltd. progressed to pretensioning after these two Magnel projects and, about



A. Murray Lount

1955, built a fine set of roof beams for National Defence at Rocky Point, West Vancouver. Victor Thorson, the structural engineer, specified a concrete strength of not less than 10,000 psi (69 MPa) which was met throughout the job!

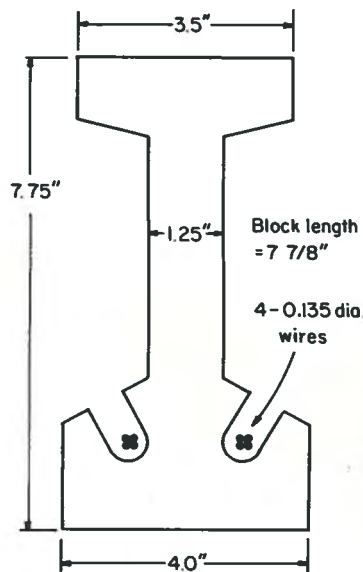

Fig. 1. Section of concrete blocks used in the construction of pretensioned joists by the Hydro Electric Power Commission of Ontario.

"The beams rang like bells and we were proud of them," reported Keith Douglas.

Muntz, by this time, was head of the Consulting Engineering Division of the Hydro Electric Power Commission (HEPC) of Ontario; I was a consultant to the Division. With the great post-war expansion program of Hydro, Muntz had greater opportunities than he had ever had before to use his imagination in the design and construction of hundreds of structures. On his staff was a young, bright, and very competent civil engineer, namely, A. Murray Lount.

In 1952, they designed a pretensioned roof purlin system to span 15 ft 6 in. (4.7 m) between Bailey bridge trusses which were used in the construction of a garage building for HEPC. The joists were segmental, each segment consisting of a specially designed block manufactured in a standard block machine. Fig. 1 shows details of this block and the purlin reinforcement.

The blocks were assembled in two parallel lines on a floor, with six joists per line. The strands were tensioned by hydraulic jacks between fixed anchorages at each end of the line and, after tensioning, screw jacks were placed to maintain the elongation. A grout gun was used to grout the tendons in the slots in the tops of the bottom flanges. The alumina cement grout used provided the required bond strength in 15 hours, after which the strands were cut by oxy-acetylene torch.

Because of the novelty of this type of construction, an extensive testing program was initiated. One phase of this program was carried out by the HEPC Research Laboratory and the other by its Construction Division. Three types of end anchorage for the tendons were investigated in the laboratory program. The first two of these consisted of one and two pressed sleeves on the tendons at each end and the third consisted of normal bond.

The tests indicated very little difference in strength between the beams; all

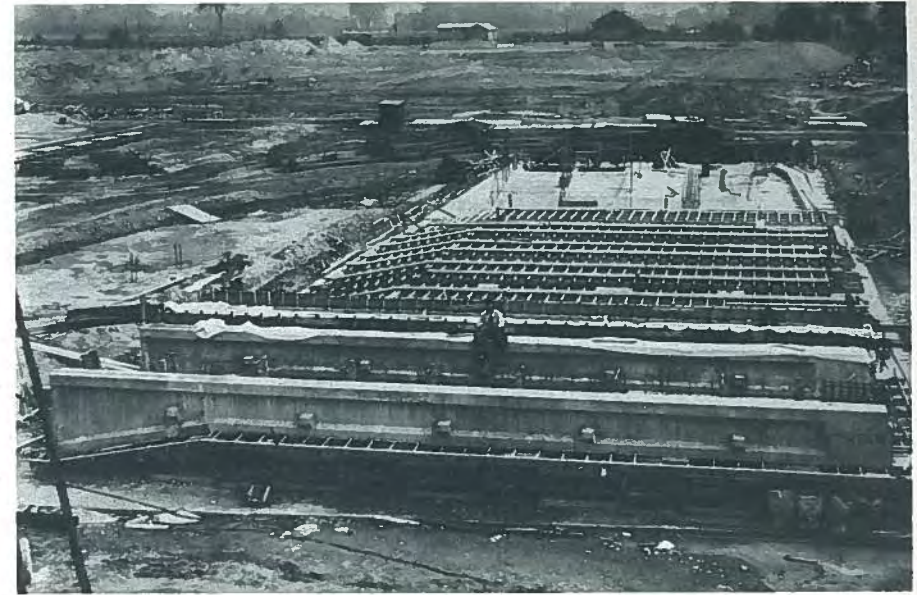

Fig. 2. Post-tensioned beams for the Canadian Army Ordnance Warehouse at Cobourg, Ontario, 1952 (Magnel system).

behaved in a predictable and satisfactory manner. However, to further assure the engineering community of the safety of these beams, during construction each beam was proof loaded, and every twelfth beam was loaded to destruction. There were no difficulties in obtaining approval of the system from the municipal building officials.

A paper describing this project was presented by Murray Lount at the Halifax annual meeting of the Engineering Institute of Canada. For this paper, Lount was awarded the Julian C. Smith Medal. By the time Lount presented his paper, he had joined Tim Lazarides to form a partnership of Structural Consultants with offices in Toronto, Montreal and Halifax.

In 1952-53, PRECO was the prestressed concrete subcontractor for the design and erection of four 200 x 500 ft (60.9 x 152.4 m) Canadian Army Ordnance warehouses at Cobourg, Ontario. Fig. 2 shows the fabrication area for the single 50-ft (15.2 m) long partially

post-tensioned girders, which were joined to companion members after erection to form two-span continuous girders. The Magnel-Blaton system of prestressing was used and a clever method was developed to produce the continuity.

This project was bid on a competitive basis along with cast-in-place reinforced concrete. Similar structures were built for the Department of National Defence in Montreal and Winnipeg. The willingness of DND to try prestressed construction was invaluable for new companies struggling to become established.

Because of the magnitude of the Cobourg project, it was decided that a full scale testing program should be conducted on one of the continuous span girders, under the joint direction of the Division of Building Research (DBR) of the National Research Council of Canada, and the Research Division of the Hydro Electric Power Commission of Ontario.

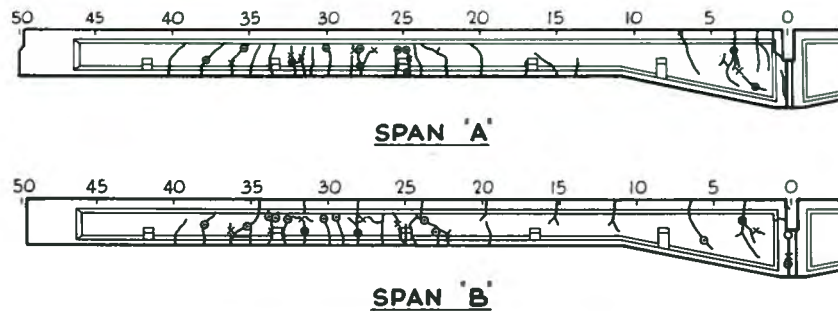

LEGEND **END OF CRACKS AT VARIOUS LOADS**

	LOAD N ^o	LOAD
○	11·6	DL+2½ LL
●	12·8	DL+ 3 LL
×	13·9	DL+3½ LL
⊙	14·12	DL+4¼ LL

Fig. 3. Test loading crack patterns for two-span continuous prestressed beams of Cobourg Warehouse.

According to information received from DBR, the test results completely verified the excellent physical characteristics of prestressed concrete. Fig. 3 shows the crack pattern at various stages of loading. The beam was first loaded symmetrically up to DL + 1½LL. It was then loaded up to an asymmetric loading of D + 1LL on Span A and then an asymmetric loading of D + 1LL on Span B.

Following this, the beam was symmetrically loaded to DL + 1½LL for 28 days. The fourth stage of loading was asymmetric and was taken to DL + 2LL. The final symmetric loading was taken to DL + 5½LL at which stage a jack instability accident occurred. No further loading was applied but the ultimate capacity was taken to be DL + 6LL.

In 1952, interest in prestressed concrete in Western Canada had reached a stage such that Ken Paget, the founder of Precast Concrete Ltd. of Calgary (now Con-Force) sent George Adam, a bright, enthusiastic young engineer, to visit Sheffield, England (specifically Lee McCall), Paris, Rouen, LeHavre, and

Freyssinet's famous Marne River bridges; and to investigate prestressing systems available in Belgium and Germany.

On September 10, 1953, a meeting which I chaired was held at the University of Toronto, for the purpose of establishing a Prestressed Concrete Development Group in Canada. Fig. 4 is a photograph of some of those attending that historic meeting. Eric P. Muntz was named chairman of the group and D. O. Robinson of the Canada Cement Company as its secretary. The number of companies interested in applying prestressed concrete was now starting to grow rapidly.

George Adam, having returned from Europe impressed and full of enthusiasm, had no difficulty persuading his company to get involved in the production of prestressed concrete. Preliminary work was begun, in 1953, on the design of concrete bridge stringers by Structural Engineering Services Limited, a consulting group headed up by Tom Lamb and Doug de Wolff.

Valuable advice was also received



Fig. 4. Officers and elected members of the organizing committee for the Prestressed Concrete Development Group at the University of Toronto present at the organizing meeting, 1953 are, left to right: D. O. Robinson, secretary; committee members J. D. Allen, R. M. Doul, Dr. T. O. Lazarides; E. P. Muntz, chairman; committee members H. King, M. W. Huggins (the author), B. A. Hesketh, F. P. Rolph, and Phillip Benn.

from James Libbey of Freyssinet's New York office, and equally valuable encouragement from the Alberta Department of Highways.

Because of concern regarding possible difficulties in handling full 60-ft (18.3 m) stringers, Con-Force's first bridge

over Ross Creek at Medicine Hat, Alberta was of segmental construction, each segment being 20 ft (6.1 m) in length. The 60 ft span by 24 ft wide (18.3 x 7.3 m) bridge (Fig. 5) was post-tensioned longitudinally as well as laterally through the deck and diaphragms.



Fig. 5. The Ross Creek Bridge at Medicine Hat, Alberta, was the province's first prestressed concrete bridge (1953).

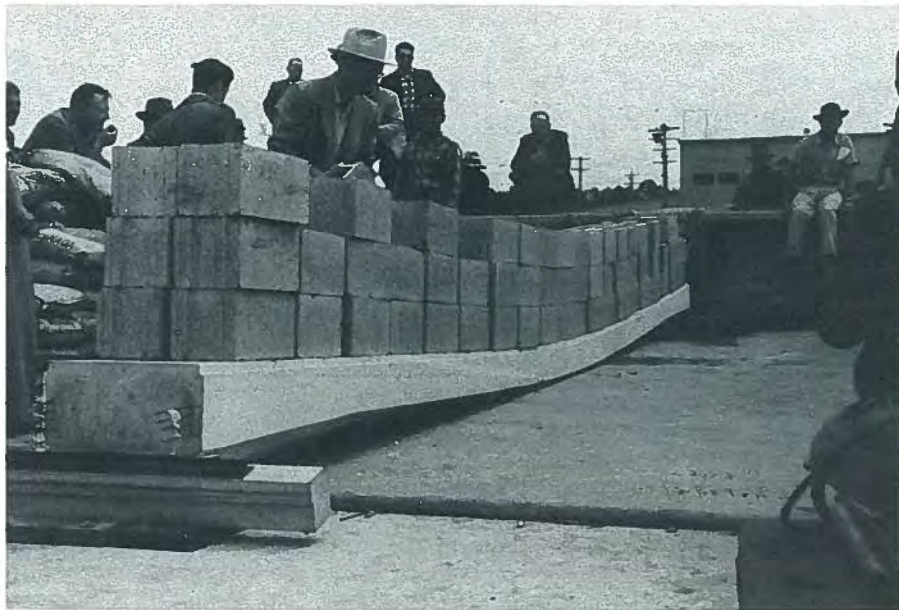

Fig. 6. Load test of prestressed concrete slab.

The bridge was erected in mid-winter Western Canada temperatures—a real test of the skills of all individuals involved. Norman Bunn, an engineer with Con-Force at this time (now the President of Dy-core Systems), contributed significantly to the success of this project.

From the experience gained on this bridge it became evident that long spans could be transported by pole trailer. Future stringers and girders were cast in one piece except in special circumstances where segmental construction was warranted.

The initial stages of promotion of building members were also underway in Western Canada, with the usual tests being carried out for consultants and architects, to demonstrate some of the superior qualities of this new building material (Fig. 6).

About the same time, the young A. M. Lount formed his partnership with T. O. Lazarides.

During the winter of 1953-54 the first

prestressed concrete bridge in Eastern Canada was built to a Lazarides and Lount design. The structure was a double-tee post-tensioned footbridge of about 40-ft (12.2 m) span on the Islington Golf Course near Toronto. This bridge was cast-on-site and prestressed under winter conditions.

The contractor was A. E. Rule Ltd. The bridge has the distinction of having been stressed by Y. Guyon, a distinguished disciple of Freyssinet and author of two important books on prestressed concrete.

In 1954, their firm, with L. G. Cazaly (recently arrived from prestressing experiences in the United Kingdom) as their chief designer, designed the first prestressed highway bridge in Ontario. The bridge was built for the Township of Sarnia in the summer of 1954.

It was the first time that 5 ksi (34.5 MPa) ready-mixed concrete had been used in Canada. With the ready mix company president present, the first batch was wetted by the driver, who did

not believe in dry concrete; the president made him dump it in a nearby hollow. The second batch was so dry that, according to Cazaly, they had to "put a bucket of water in to get a bucket of concrete out." It took 3 hours, on a hot sunny day, to place 5 cu yds (3.8 m³) of concrete. Despite all these difficult conditions, the beams turned out to be perfect!

In the same summer of 1954, the Chin Coulee Bridge was built in Alberta by Con-Force (Fig. 7). This curved bridge consists of 100 60-ft (18.3 m) girders. One-hundred-and-one girders were cast in the Calgary plant; one of these girders was to be fully load tested. Dr. Ralph McManus of T. Lamb, McManus and Associates (formerly Structural Engineering Services) was highly impressed when the actual failure of the test girder occurred at a load only one percent higher than what he estimated would be the predicted ultimate capacity of the member.

In 1954-55, the first rigid frame prestressed concrete bridge in Canada was built in the Village of Richmond, about

15 miles west of Ottawa. This bridge over the Jock River has an 84-ft 5-in. (25.7 m) clear span and is 32 ft (9.75 m) wide with a 36-deg skew.

The Freyssinet prestressing system was used. The contractor was W. D. LaFlamme Ltd. of Ottawa; the resident engineer was W. D. Paton. The principal consultant was C. C. Parker and Associates Limited, of Hamilton Ontario and the specialist consultant for the prestressing was T. O. Lazarides & Lount of Toronto, Ontario.

In 1954, the Sussex Street bridges in Ottawa were designed and built by PRECO. Extensive tests were conducted to determine the load distribution characteristics of the bridges. The tests were done under the joint direction of DBR and HEPC (Ontario).

The excellent results were reported in the Proceedings of the World Conference on Prestressed Concrete at San Francisco in 1957, by W. D. Houston of HEPC and W. R. Schriver of DBR. Bill Houston was later to become an associate of L. G. Cazaly after the latter had set up his own practice.

Fig. 7. The Chin Coulee Bridge, built by Con-Force in Alberta, 1954.

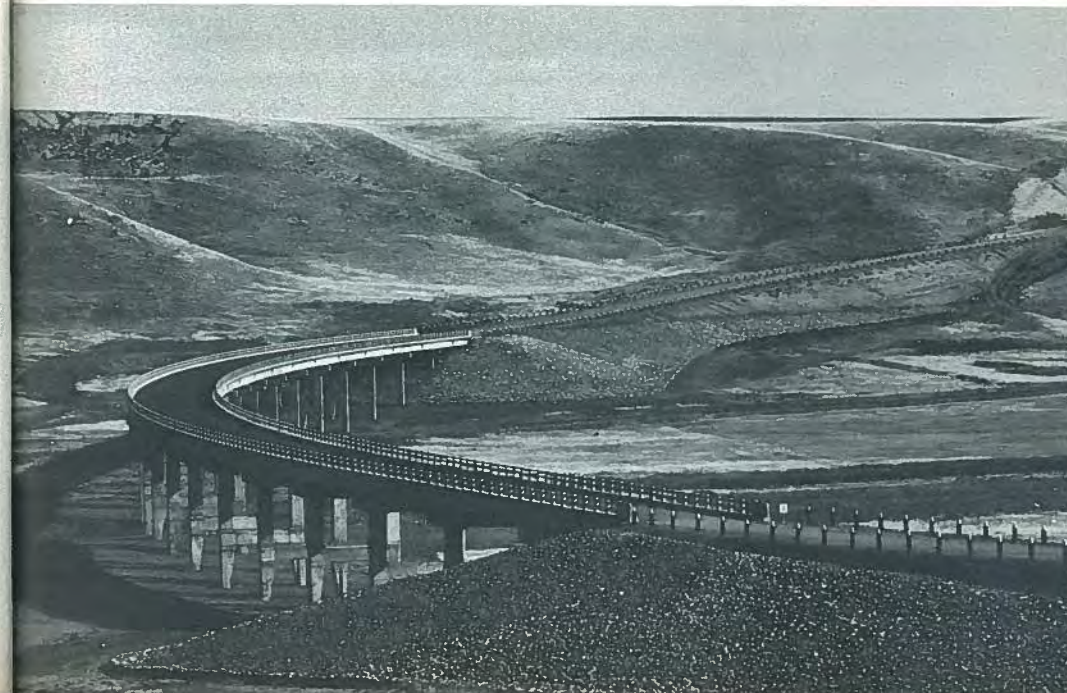



Fig. 8. School for the Deaf, Edmonton, Alberta, 1955—complete precast column and beam framing and prestressed double tee floor and roof slabs.

Later in 1954, the first major prestressed concrete building project in Edmonton, the School for the Deaf, was designed by the Alberta Government Department of Public Works (Fig. 8). This project includes precast post-tensioned girders with spans up to 90 ft (27.5 m) which were erected on precast columns at 20 to 30 ft (6.1 to 9.2 m) on

centers for this multi-wing 100,000 sq ft project.

Double tee units 5 ft (1.5 m) wide with 12 to 20-in. (305 to 508 mm) leg depth were then placed from girder to girder to form the total roof for this project. At this stage, Freyssinet cables [12 0.196-in. (5 mm) diameter wires!] were stressed through the column and girder

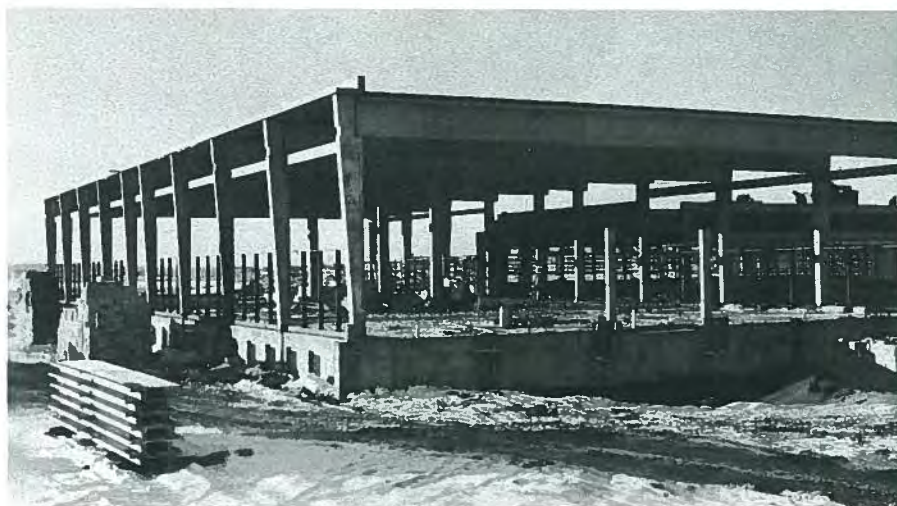

Fig. 9. School for the Deaf under construction.



Fig. 10. The barn in which Wilson Concrete Products of Belleville, now part of Stanley Structures, began the manufacture of concrete blocks.

to provide additional capacity for live load and securely tie the building together (Fig. 9).

This 25-year-old prestressed building looks today as good as when it was first built. Indeed, it is a tribute to the confidence specifying authorities placed in this innovative product which was being marketed in the mid-fifties.

On January 28 and 29 of 1954, the Canadian Conference on Prestressed Concrete was held at the University of Toronto; among the speakers at this well attended and successful conference were Professor Gustave Magnel, and Robert Sharma, managing director and chief engineer for Empresaro Campenon Bernard de Venezuela, Caracas.

Sharma described two daring bridges which had been designed by Freyssinet and built in the mountains near Caracas. Each bridge contained a 500-ft (152 m) arch span which used prestressing extensively during erection. The bridges also contained a number of post-tensioned girder spans. This paper was the gem of the conference.

On April 21-22, 1955, the First Annual Meeting of the Prestressed Concrete Institute took place at Fort Lauderdale, Florida. George Adam of Con-Force and

Mack Curzon, representing Charles Wilson and Wilson Concrete Products Ltd. (WCPL) of Belleville, Ontario, were the only Canadians in attendance. At this time, Mack was employed by a Toronto consultant and was giving serious thought to joining WCPL.

Mack Curzon returned with a very favourable report on prestressed concrete. He became a principal of WCPL during the summer of 1955, and immediately began work on the design of their new plant—quite a change from the old barn in which the firm had begun as a block manufacturing factory (Fig. 10). The new plant (Fig. 11) became the most successful precasting facility in Eastern Ontario.

With the financial support prestressed concrete was receiving at this time, it was well on its way to widespread use. However, its complete acceptance by municipal building officials had to wait until the Canadian Standards Association A135-1962 Standard for Prestressed Concrete was published in 1962.

L. G. Cazaly had, by 1955, formed his own consulting firm, and, in that year, designed the Parkdale Avenue Bridge (Fig. 12). This design, for Schwenger

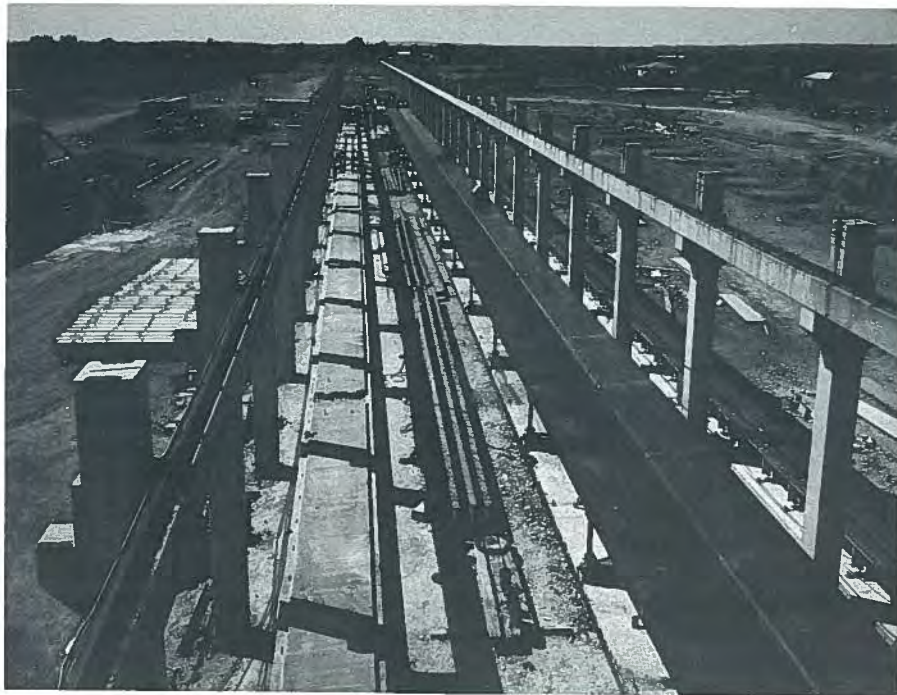

Fig. 11. The modern plant of Wilson Concrete Products under construction (1956).

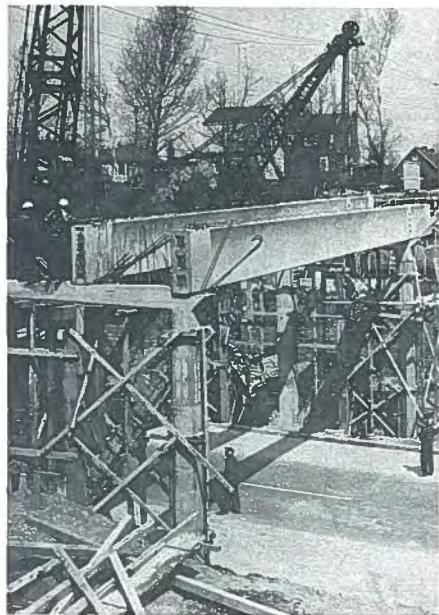

Fig. 12. The Parkdale Avenue Bridge, with the first use of curved web forms, designed in 1955 by L. G. Cazaly.

Construction Co. Ltd., was a successful competitive alternate. On this job, Cazaly used for the first time the curved plywood web forms that became his trademark for several years thereafter.

The segmental bowstring roof trusses of the Birchmount garage for the Toronto Transportation Commission (Fig. 13) were designed by Cazaly. This job also was bid competitively against a structural steel design. The prestressed concrete was fabricated by Toronto Cast Stone; the Gifford Udall system was used for stressing the structure—probably its only use in North America.

The design was light and low in cost (about 20 psf or 1.85 MPa, and less than \$1.00/sq ft or \$10.76/m² without roof deck), but the structure is not particularly aesthetically pleasing. A more elegant design by Cazaly using similar principles was the Royal Yacht Club Footbridge at Centre Island, Toronto (Fig. 14).

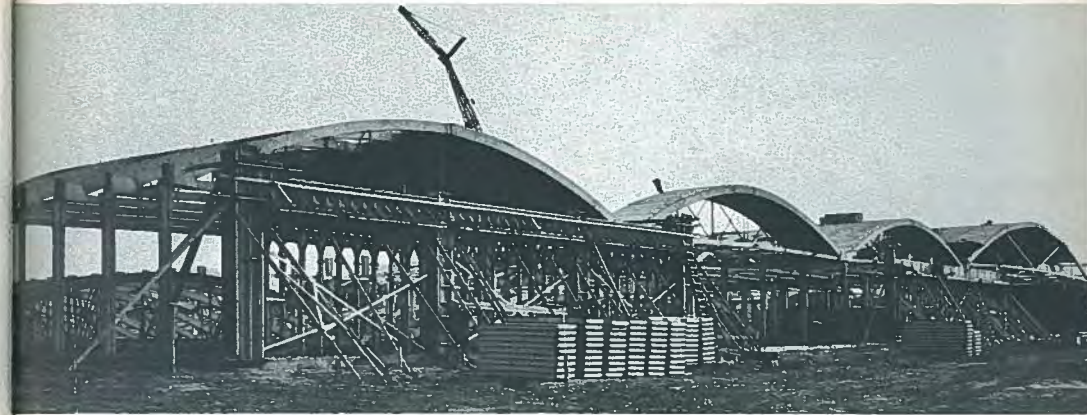

Fig. 13. Segmented prestressed bow-string trusses for the Birchmount garage of the Toronto Transportation Commission.

By 1956, Wilson Concrete Products was experimenting with the fabrication of pretensioned double-tee sections cast in a concrete form made sufficiently strong to resist the tendon forces. This proved to be an uneconomical and inefficient method of manufacture. Their next moulds were made of fiberglass, which also proved to be unsatisfactory

because they wore out quickly and had inadequate strength. In the following year, WCPL purchased steel double tee forms from Formcrete of Lakeland, Florida. The company was now ready for mass production.

During the same period Wilson was constructing his plant in Belleville, Kai Holbek and Harry Lay, long-time em-



Fig. 14. Prestressed concrete footbridge for the Royal Canadian Yacht Club of Toronto, designed by L. G. Cazaly.



Fig. 15. Don Mills Skating Rink, Toronto, Ontario.

ployees of Vic Murray, started a precast prestressed plant in Maple, Ontario. Shortly thereafter Schell Industries of Woodstock also entered this new business.

Standard Prestressed Structures Ltd. supplied many outstanding projects in the Toronto area, in particular a 125-ft (38.1 m) long folded slab roof over the Don Mills Skating Rink (Fig. 15). It was an early application of segmental construction with each 10-ft (3.05 m) wide slab made in three pieces post-tensioned together at site.

They also built a 50,000 sq ft (465 m²) precast concrete hangar at Toronto Airport with only one interior center column. The 140-ft (42.7 m) beams and 60-ft girders 10 ft high (18.3 x 3.05 m) were cast on the taxiways.

Another breakthrough in Toronto was the five-story Parkway Vocational School where all floors and loadbearing walls are single tees (Fig. 16).

Kai Holbek recalls an early incident which occurred shortly after Standard Prestressed Structures entered the single tee business. He received a call

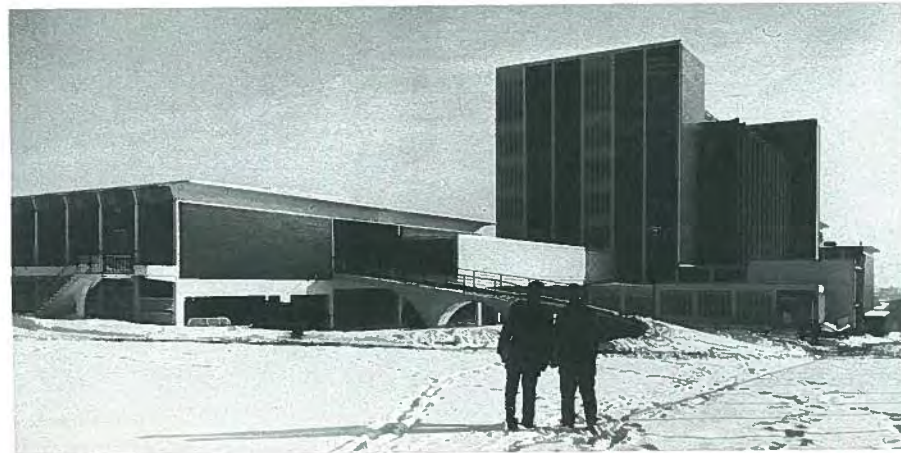

Fig. 16. Parkway Vocational School, Toronto.

from their construction manager on the job site which was about as follows:

"When will you engineers stop making so many U's out of the products and equipment? I have a single tee which was a little off a vertical when we started to lift it from the truck. It is now U-shaped and so are the spreader bars and crane boom."

The first prestressed concrete bridge for the Department of Highways of Ontario was built in 1956. The 120-ft (36.6 m) single span bridge was designed by Cazaly; the prestressing subcontractor was Schwenger Construction. The girders were cast on site and made use of Cazaly's famous curved plywood web forms.

The members were somewhat inefficient from a prestressing viewpoint but the form cost was low. However, they were very heavy (95 tons or 86.2 t) and a serious problem arose in handling them.

The intention was to lift the girders into position by two 80-ton (72.6 t) cranes, but at construction time, the cranes were not available. It was then decided to lift the members by one 65-ton (59 t) crane at one end and two 45-ton (40.8 t) cranes at the other.

Unfortunately, one crane operator was not looking when the erection foreman signalled a boom swing; and one of the 45-ton (40.8 t) cranes pulled down the other's boom, dropping the load. The resulting spall in the bottom flange was re-

paired with albitol. Despite the rough handling, the girder is in excellent condition today.

In 1957, the first of the Cazaly/Toronto Cast Stone warehouses were erected. The main beams for the roof structure were made of variable depth to avoid the necessity of draping the strands. The second of these warehouses was an extension to a warehouse which had been designed and built by PRECO. This extension used curved main beams and Cazaly hangers and resulted in a very aesthetically pleasing structure (Figs. 17 and 18).

All of these warehouses used prestressed concrete framing with the cheapest 8-ft (2.4 m) span roof deck available. In Toronto this meant a steel deck, while two in the Prairies had wood decks. All were private sector jobs which competed on a straight cost basis with structural steel, i.e., for about 85¢/sq ft (\$9.15/m²) complete.

In 1957, the 356-ft (108.5 m) Nelson River Bridge in Manitoba was designed by Integrated Engineering Consultants of Montreal and was precast by Supercrete of St. Boniface. The bridge was originally designed entirely in prestressed concrete as a three-span structure with a drop-in section in the center span. Each of the two end girders consisted of nine segments, match-cast. Because of time limitations and anticipated difficulties in handling the drop-in



Fig. 17. One of the Cazaly/Toronto Cast Stone type of warehouses (1957).



Fig. 18. Purlins framing into curved prestressed beams which used Cazaly hanger type connections. This framing system was used for many warehouses.

section, this part of the structure was changed to structural steel.

Figs. 19 and 20 show the bridge under construction. In Fig. 20 the counterweights used while launching the end girders can be seen. The girders were launched in pairs using hydraulic jacks

to provide the horizontal thrust. At the time of its construction, this was the longest precast, post-tensioned, single-span bridge in North America.

Fig. 21 shows a group of fourth-year civil engineering students from the University of Toronto class of 1959 observ-



Fig. 19. The three-span Nelson River Bridge under construction in Manitoba (1957).

ing a test of a double tee unit at Wilson Concrete Products Limited. In front are Mack Curzon on the left and myself on the right.

This type of field trip very effectively acquainted civil engineering students with what were, to them, the surprising characteristics of prestressed concrete. Large deflection without failure was the main feature of the beam's behaviour which most impressed the students, although its complete recovery in unloading without visible cracks was almost equally surprising to the class.

In 1958, Cazaly introduced the use of colored concrete in his curved web girders in two bridges in Hope and Clarke Townships, Ontario (one red and one green).

This, possibly the first use of coloured concrete in bridges in North America, was viewed with a certain amount of skepticism at the time but has since been widely applauded.

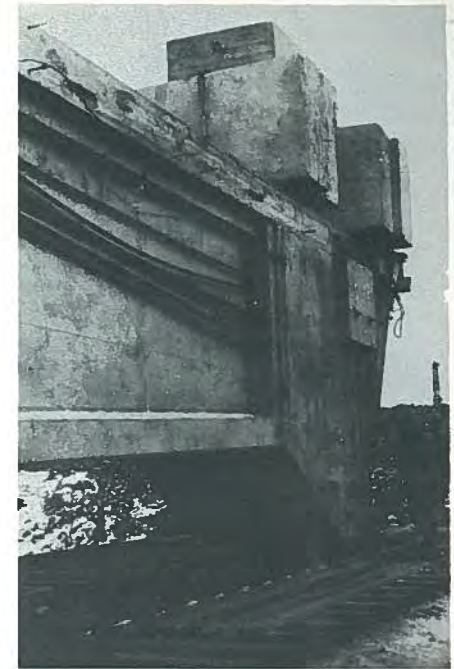

Fig. 20. Launching Nelson River Bridge.

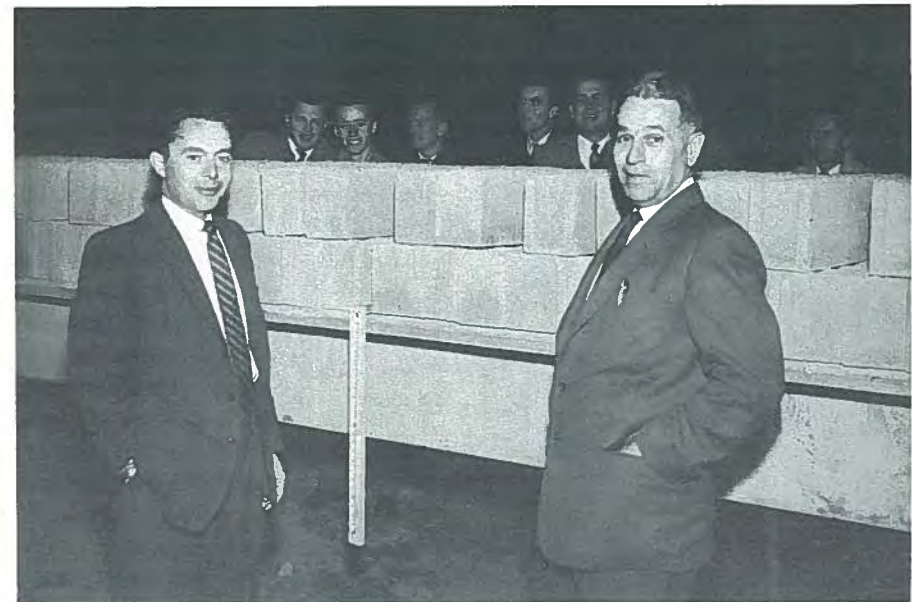

Fig. 21. A group of final year civil engineering students observing a test of a double tee at the Wilson Concrete Products plant. In foreground: Mack Curzon (left) and Mark Huggins (the author of this paper).



L. G. Cazaly

In 1959, WCPL produced what was probably the first Lin tee in Canada. In that year, Cazaly spoke at the annual meeting of the Prestressed Concrete Institute in New York City and received the Martin P. Korn Award. The title of his address was "Neat Joints—a Good Business." L. G. Cazaly had by this time

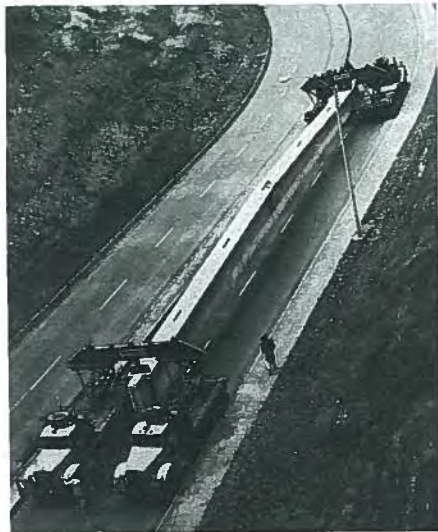

Fig. 22. Transportation of 140-ft (31.9 m) girders for University of Alberta gymnasium.

established a reputation for pleasing designs involving cleverly designed connection details.

Later that year the expansion program at the University of Alberta included requirements for a new gymnasium with 140-ft (42.7 m) clear spans as well as a hockey rink with 150-ft (45.8 m) clear spans. The 140-ft (42.7 m) girders were cast in one piece and transported across town to the site using special equipment and four truck/tractor units (Fig. 22).

The 150-ft (45.8 m) girders, however, were produced in three sections which were transported to the site. There, the girder elements were connected with cast-in-place joints and post-tensioned to produce a 150-ft (45.8 m) girder which was then elevated in place between twin precast concrete columns (Fig. 23).

In 1960, an interesting development occurred in Winnipeg, Manitoba. Grosvenor House (Fig. 24), an 8-story building, had been designed as cast-in-place concrete. At the time of its design, prestressed concrete was not accepted by the building officials of the City of Winnipeg but had already been in use for some time in the immediately adjoining municipalities which, with Winnipeg, were to become Metro Winnipeg.

When it came time to call for bids it had already become evident that Metro was imminent and that some use of prestressed concrete would be permitted. Hence, Building Products and Coal Ltd. (BPC), later PRECO, and now Con-Force, submitted a bid based upon a precast concrete structure with the floor units being prestressed. Glen Booth of BPC invited Cazaly out to design a few connections. About 100 shop drawings later, Grosvenor House became a reality.

This building was for some years the tallest all-precast concrete structure in Canada; the peculiar framing system will probably remain unique. The center core resists all lateral loads. Seven beams and four bracing members frame into each core column joint at each floor. Such difficult connection details would

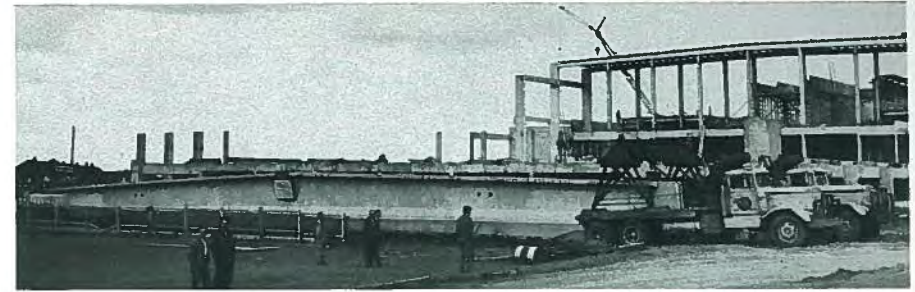

Fig. 23. Beams ready for erection at the gymnasium.

not have arisen if the original design had been in prestressed concrete.

Grosvenor House was soon followed by the Gladstone Overpass on the West Perimeter Highway of Winnipeg. This four-lane bridge has four 78-ft (23.8 m) spans of prestensioned box girders. The fabrication of the girders was carried out

in a pipe-making plant with a pretensioning bed long enough for the production of four girders in one line.

The plant had only 20 ft (6.1 m) of headroom and no crane; hence, considerable planning was required, not only in solving form floatation problems during casting, but also in developing a system



Fig. 24. Grosvenor House in Winnipeg, tallest all-precast building in Canada at the time of its construction (1960).



Fig. 25. The original 20,000 seat McMahon Football Stadium in Calgary, completed in 6 weeks in 1960.

for removing the girders from the plant. Two steel gantries running on rails were built to straddle the girders. These were used to raise the beams by hydraulic jacks so that they could be supported on a "linked roller" system. The girders could then be withdrawn by a winch located in the yard.

Equally difficult problems arose in unloading the girders by drag line (no crane was available). It required 12 hours to unload one such girder.

Building Products and Coal Ltd. was the first to produce prestressed concrete piles as an inventory item. According to Don Elliot, this was a decision of major economic importance. It meant that piles could be manufactured in slack periods. A direct consequence of this decision was that the cost of prestressed concrete piles, driven, remained constant in the Winnipeg area for 10 years. This is a good example of far-sighted decisions which have kept the prestressed concrete industry in Western Canada in the forefront in engineering, management and marketing.

In 1962, the same firm obtained a contract which required the use of Flexi-core hollow-core slab units. It was im-

mediately decided that they would try to produce prestressed hollow-core slabs for the contract. In attempting to produce these, they tried to adapt a Dunn beam machine, which had been used earlier for precast units. After much effort and no success, they called on two electrical men, Fred Ellis and Marvin Thornsteinson, of Dominion Armature Works, to see whether some form of magnetic vibration could be used to improve the operations.

The two men examined the process and advised that it would be a waste of time and money to put any more effort in this direction. They departed and, after some thinking, they produced the design of the Spiroll process for manufacturing extruded pretensioned hollow-core slabs. The first prototype was used on the BPC contract.

The system is still used widely in Canada and throughout many parts of the world for production of hollow-core slab units. It is significant to note the leadership provided by the Spiroll organization and more recently by the Dy-Core organization in production and distribution of equipment to manufacture hollow-core floor, roof and wall products

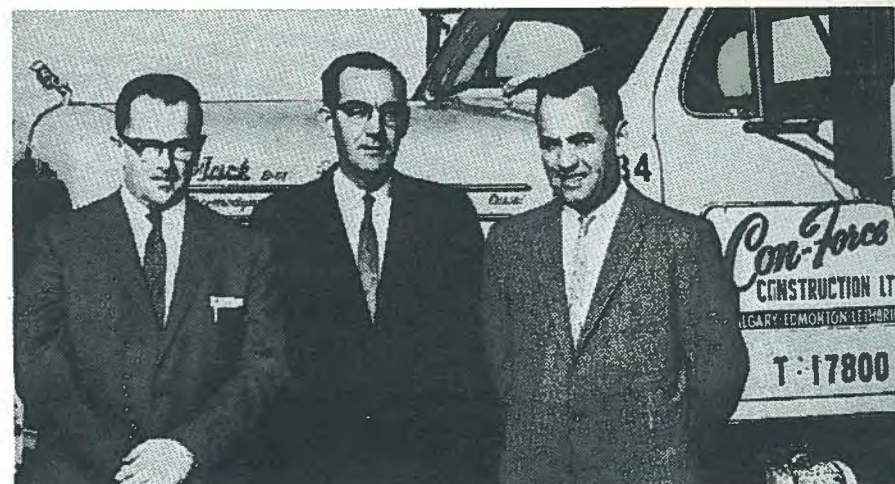

Fig. 26. The Con-Force operational team, from an early brochure. From left to right: George Adams, R. W. Brookes-Avey and A. W. (Art) Falk.

for the prestressed concrete industry throughout the world.

In the meantime, the use of prestressed concrete was growing rapidly throughout Canada. In 1960, Con-Force built the original 20,000-seat McMahon Football Stadium in Calgary (Fig. 25) in 6 weeks. Fig. 26 shows the Con-Force operational team from an early brochure entitled "A Portrait of Growth."

In the same year, Wilson Concrete Products Limited began producing long line 18-in. (457 mm) wide hollow-core slabs which were patterned after Flexi-core. Very shortly the decision was made to change the 18-in. (457 mm) width of the slabs to 4 ft (1.22 m).

In early 1961, after several attempts nationally by Kai Holbek, a group of precasters decided to form a Canadian Prestressed Concrete Association. Included among these early precast companies were Standard Prestressed Structures, Beer Precast, Schell Industries, Con-Force Products, Supercrete, Wilson Concrete Products, Murray Associates, and Schwenger Construction.

This initial meeting was held in the Holbek living room in Richmond Hill, followed by the first official meeting in

Toronto on September 12, 1961, and the first Annual Meeting at the PCI Convention in Denver, Colorado, on October 14, 1961. The Charter Officers of the Canadian Prestressed Concrete Institute were Kai Holbek (President), Conrad Festing (Vice President), and Doug Beer (Secretary-Treasurer).

In 1962, J. T. Trimble of the Alberta Department of Highways presented a paper in which he outlined the development of the use of prestressed concrete in Alberta's bridges. Beginning with the early encouragement provided Con-Force in 1953 for the manufacture of the prestressed concrete bridge stringers, 1148 prestressed concrete bridge girders were in use in Alberta by 1962, totalling 85,000 ft (25,910 m) in length and with spans varying from 50 to 148 ft (15.2 to 45.1 m) with the majority being 60 to 90 ft (18.2 to 27.4 m). The longest bridge was 1500 ft (457 m).

The specifications which had been used in the design of these bridges were:

1. AASHTO H20-S16 for loading
2. The U.S. Bureau of Public Roads Criteria for Prestressed Concrete Bridges (1954) for allowable stresses,



Fig. 27. Handling the 148-ft (45.1 m) post-tensioned girders for the Duchess Bridge on Highway 36 across the Red Deer River.

load factors and losses, and

3. The ACI-ASCE Joint Committee Tentative Recommendations for Prestressed Concrete for general reference and fabrication.

At the time of Trimble's report, CSA A135-1962 had just been published.

All of the above Alberta bridge stringers were pretensioned and plant manufactured except for the 148-ft (45.1 m) span girders of the Duchess Bridge, located on Highway 36 across the Red Deer River. Fig. 27 shows one of the girders of this bridge and the method which was devised for handling the "monsters."

The largest and most impressive application of prestressed concrete in Canada occurred between 1959 and 1962 in the Champlain Bridge which spans the St. Lawrence River and the Seaway at Montreal. This \$35,000,000 six-lane toll bridge was opened to traffic in June 1962. The consulting engineer was H. H. L. Pratley; Dr. Roger Dorton was chief engineer.

The major structural contracts for this project were let in the summer of 1959.

In calling for bids, alternative designs were invited. A total of 28 bids were received on the first and major part of the superstructure. The six lowest bids were in prestressed concrete with an average tender price 17 percent less than the nearest structural steel bid. The low bid was submitted by a consortium of McNamara-Key-des Champs.

Figs. 28 and 29 show views of parts of the bridge under construction. The contract consists of 46 prestressed concrete simply supported bridge spans each 176 ft (53.6 m), supported on T-shaped piers founded on bed rock. The shape of the piers greatly reduces the ice forces to be resisted. The contractors successfully completed two spans per week.

The design was by Wardycha & Skotecky, Consulting Engineers of Montreal in collaboration with Entreprises Fougolle, and Société Technique pour l'Utilisation de la Précontrainte, both of Paris, France. The Freyssinet system of prestressing was used.

The first Canadian "Standard for Prestressed Concrete, CSA A135-1962" was published in March 1962. This 1/8-in.



Fig. 28. An overview of the Champlain Bridge over the St. Lawrence and the Seaway at Montreal (built 1959-1962).

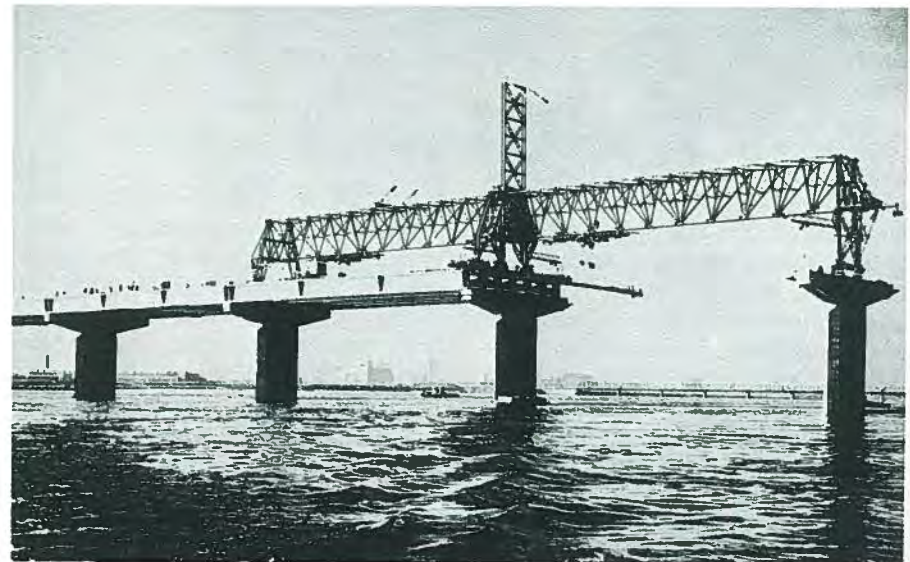

Fig. 29. The Champlain Bridge under construction: the largest application of prestressed concrete in Canada, and the most impressive from the viewpoint of low cost.

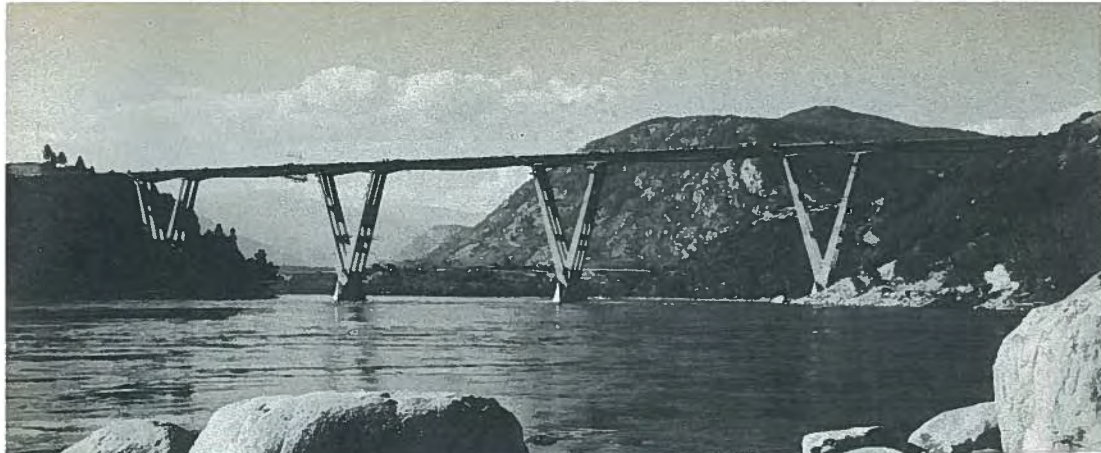

Fig. 30. The Kinnaird Bridge, Columbia River, British Columbia.

(3.18 mm) thick document, which at one stage in its development was 1/2 in. (12.7 mm) thick, overcame the last objections to the use of prestressed concrete in Canada.

In 1964 a very pleasing bridge was built to cross the Columbia River at Kinnaird, British Columbia. The project required 15 special 150-ft (45.8 m) long drop-in girders which were cast and tensioned at the site by Con-Force for the general contractor (Fig. 30). The design was by Choukalos, Woodburn and McKenzie Ltd. (and Professor Morandi), Vancouver, B.C.

In 1964, the Canadian Prestressed Concrete Institute Handbook, written by Cazaly and Huggins, was published. This represented a significant and ambitious undertaking by the Canadian Producers and Associate Members of CPCI. The purpose of this Handbook was to promote the understanding and use of prestressed concrete by Canadian engineers and to aid the continuing growth of this industry which had made such impressive strides in little more than a decade of application in Canada.

Today, there are approximately 40 Canadian plants certified by the Canadian Standards Association as qualified to produce high quality prestressed products, ranging from railway ties to bridge members. There is, as well, a

large body of contractors competent to produce on-site post-tensioned and pretensioned structures of all types, and prestressed concrete has been established in a dominant position in highway bridge construction.

No story of the early development of prestressed concrete in Canada would be complete without reference to Kai Holbek's contribution as a prime mover in the establishment of the Canadian Prestressed Concrete Institute and the Precast Concrete Plants Certification Program. Others who have contributed, each in his own special way, include Vic Sibley—the PRECO construction superintendent, turning Phillip Benn's designs into reality and who later joined Pre-Con; Don Paton, who contributed significantly both as manager of a prestressing plant and also an engineer with the Ministry of Transportation and Communications of Ontario, and with C. C. Parker and Associates; and Vic Murray who founded Murray Associates, which later became Pre-Con Murray.

I am particularly indebted to Cipriano Da Re, who is presently Special Project Manager of Francon in Montreal. He was with PRECO from 1952 until 1956 at which time he joined Supercrete in Winnipeg as their plant manager where he was involved in the fabrication of the Nelson River Bridge.

Concluding Remarks

When prestressed concrete was developed in Europe, nearly all structures were post-tensioned. However, when North Americans became interested in prestressed concrete, their well-established skills in mass production led to the rapid development of the pretensioning technique for a great variety of structures.

Their development of long-line fabrication methods for double tees, single tees, I-beams, hollow-core slabs, and other products represents one of the great contributions to the practice of prestressing.

The use of pretensioning has resulted in the majority of structures in North America being simple span rather than continuous. This in turn has led to designs in which problems have arisen because of the effects of shrinkage and creep. The publication of the first CPCI Handbook and later the excellent PCI Design Handbook has provided the designer with procedures and calculation methods for dealing with these problems.

Notwithstanding these aids, the effects of creep, shrinkage and rapid temperature change continue to be a problem area to engineers who do not properly analyze the behavior of their struc-

tures, and who fail to follow the advice of the handbooks and other literature for good detailing. Thus, the need for continuing education is very important.

As engineers and manufacturers continue to develop other innovations, each new process will bring with it new challenges to the profession and the industry to examine it carefully for potential new problems. In today's practice, in which the legal liability of the design engineer and manufacturer have been increasing astronomically, to the benefit of the legal profession, it has become imperative that the engineer and producer must satisfy themselves that their:

- (a) Structures have adequate safety, and their
- (b) Products have a guaranteed long-range service performance, thereby fostering the growth of their industry.

It may well be, that the only effective course of action for the future prosperity of the precast and prestressed concrete industry is to develop integrated organizations involving design, research and development, and manufacturing along the lines suggested by Dr. Arthur Anderson in this current issue of the PCI JOURNAL.

References

1. Douglas, M. K., "Prestressed Concrete" *The B. C. Professional Engineer*, November 1951, pp. 9-11.
2. "Prestressed Concrete Beam Test," *The B. C. Professional Engineer*, October 1952, pp. 22-24.
3. Sanderson, A. B., "First Prestressed Concrete Bridge," *The B. C. Professional Engineer*, May 1953, pp. 36-37.
4. Lount, A. M. "Prestressed Concrete Applied to Roof Joists," *The Engineering Journal*, October 1953, pp. 1311-1314.
5. "Bridging the Rapids," *Winnipeg Free Press*, January 25, 1958, p. 27.
6. *The Champlain Bridge*, Porcupine Publications Ltd., Montreal, P. Q., October 1962. Text by Roger A. Dorton, project engineer with H. H. L. Pratley, Consulting Engineers; and by individual contractors. Photographs by Hans Van Der Aa.



Part 9—
The End of the
“Beginnings”

by
Charles C. Zollman

Part 9

The End of the "Beginnings"



Charles C. Zollman
Consulting Engineer
Newtown Square, Pennsylvania

"The ultimate measure of a man is not where he stands in moments of comfort and convenience, but where he stands at times of challenge and controversy . . ."
Martin Luther King, Jr., 1963

We have come to the end of the "beginnings" of prestressed concrete in North America—a historically important era—the remembrances of which have been appearing in the last ten issues of the PCI JOURNAL.

Starting with the May-June 1978 JOURNAL, various authors have narrated their own personal account of the pioneers and the events and developments that took place during the early formative years of the precast and prestressed concrete industry in the United States and Canada. They presented not only their interrelated achievements, perseverances and successes, but also their frustrations and failures.

Still, they have been unable to cover all of the significant feats of

the late forties and fifties which caused prestressed concrete, less than 25 years later, to become a highly respected segment of the heterogeneous construction industry.

The purpose of this closing paper, then, is to fill in the most glaring gaps left in this narrative of the events of the relatively distant past, and to bring out the dramatic interdependency and interlocking of events. A further purpose of this article is an attempt to provide a cohesive historical sequence of the events.

The memories of most of the occurrences presented here still linger very vividly in my mind today. I recount them because they not only contributed to the remarkable

In this concluding paper, the author pulls together the various threads of history spun in previous parts of this series and fills in the gaps still left in the story of the early years of the precast prestressed concrete industry.

development of prestressed concrete in North America but also because that early era depicts an intensely human story.

* * *

The various parts of this series make it abundantly clear that, for those who were directly involved (at times agonizingly so) in the events they describe, the late forties and early fifties were the

once-in-a-lifetime golden age. Unhampered by stifling and restrictive building codes, which as yet did not have any provisions for prestressed concrete, they could design on the basis of their own design criteria and engineering judgment.

They were not afraid to accept the responsibility for the structures they conceived and designed in the new material, even though they did not always fully understand the short term, much less



Fig. 1. The Walnut Lane Bridge under construction in 1950. Photograph shows brackets in place for formwork for sidewalk at south fascia girder.

The Author

Charles C. Zollman was instrumental in the promotion, development, design and construction of Philadelphia's Walnut Lane Bridge, the first major prestressed concrete bridge in North America. He was the first chairman of PCI's Technical Activities Committee from 1957 to 1960 and an active participant in PCI affairs as director from 1956 to 1959.

Mr. Zollman's early consulting services for the design and construction of pretensioning plants throughout the United States, his activities in the field of precast concrete as well as his many contributions to the PCI, have identified him as a pioneer of this industry in North America.

Mr. Zollman was a student of Professor Gustave Magnel at Ghent University, Belgium. Later, he became Magnel's unofficial representative in the United States, responsible for the detailed arrangements of Magnel's several trips to this continent.

In tribute to Mr. Zollman's years of service to PCI, and to his pioneering efforts in prestressed concrete, as well as his continuing interest in design and construction with precast and prestressed concrete, he was awarded the PCI Medal of Honor in 1979.

the long term, behavior of prestressed concrete structures. But they were wise enough to be careful in their endeavors.

This enthusiasm led to the construction of the Walnut Lane Bridge (Fig. 1),

as recounted in Part 1, which set the stage for later developments. It established once and for all that the concept of prestressed concrete was sound. But it also became apparent that, regardless of its merit, the concept could not be used extensively on this continent in its European form—as such, it was simply not competitive with other available materials.

The reason was that European and American construction philosophies were diametrically opposed. In the former, each engineering project was primarily considered as a custom-made venture, with the amount of labor only secondary; the strength of the latter was the assembly-line procedure which has yielded such dramatic economical results in a myriad of other American enterprises.

Professor Magnel recognized this difference in philosophy when he stated, in 1954, at the Canadian (Toronto) Conference on Prestressed Concrete:

“... In the United States, industry is developed in a wonderful way ... This is due in part to an internal market of 160 million people ... This has made possible the enormous development of mass production and the introduction of highly specialized labor saving machinery ... Unfortunately, in bridge building, one cannot apply the idea of mass production ...”

For once Professor Magnel was wrong. He underestimated American ingenuity, power and capabilities. What he thought was impossible—namely, assembly line mass production of pretensioned structural elements capable of carrying heavy loads over large spans—came to pass, even while Professor Magnel was expounding his ideas. But, in his defense, remember that the Professor was educated, lived and worked in Belgium, about the size of the State of Rhode Island and Maryland combined, where everything was on a small scale.

To him, pretensioning meant bond by the smooth, 2 mm (0.079 in.) maximum diameter wires then in use in Europe. It was applicable only to relatively short members such as small joists and planks, to carry light loads, i.e., roof loads. Grinning ear to ear, with a twinkle in his eye, he would state: “I cannot get excited about ‘toys.’ I think of the use of prestressed concrete in terms of large civil engineering projects.”

The Catalysts

As narrated in Part 2, the key to plant production of pretensioned structural elements which could carry substantial loads was the development of the 7-wire strand. It was the tool for which daring, imaginative and creative engineers and builders were waiting, so that they could jump into the fray.

Before builders could even realize what was happening, pretensioned structural members were already being conceived, designed, and produced in such widespread areas as Pottstown, Pennsylvania (Part 2), Florida (Part 3), Colorado (Part 6), and New Orleans, by men ferociously zealous of their independence, such as Ben Baskin, Ross Bryan, Harry Edwards, the Perlmutter brothers, Walter Blessey, and Arthur Anderson.

Each of them was paddling his own canoe with no, or at best very little, contact with each other, their concerns limited to their own marketable areas of about 100 to 150 miles (160 to 240 km) wide.

But where and how did these widespread activities originate? What were the common threads? What were the catalysts?

The only production vehicle all these men had in common was strand manufactured specifically for use in prestressed concrete work. Before 1952, only two firms in the world produced



Professor Gustave Magnel

such strand, John A. Roebling's Sons Company of Trenton, New Jersey, and United States Steel Corporation of Pittsburgh, Pennsylvania.

About 1952, they were joined by Union Wire Rope Company of Kansas City, Missouri (Part 5), now known as Armco Steel Corporation, but only after much of the basic development work had been completed by Roebling and U.S. Steel. Armco started then and has continued to this day, a successful research and development program of its own.

As the years went by, through continuing costly in-house research and development programs and improved metallurgical controls, these firms developed larger strands, up to 0.6 in. (15.2 mm) diameter. They increased their tensile strengths up to 270 ksi (1862 MPa) and improved other physical properties of the strands, such as their creep characteristics. In addition, incidental equipment, such as the reel-less center pullback, was developed.

Eventually, these high quality wire products were duplicated by wire manufacturers throughout the world: indeed, strands made specifically for prestressed concrete work has been a substantial American contribution to the world.

The Author

Charles C. Zollman was instrumental in the promotion, development, design and construction of Philadelphia's Walnut Lane Bridge, the first major prestressed concrete bridge in North America. He was the first chairman of PCI's Technical Activities Committee from 1957 to 1960 and an active participant in PCI affairs as director from 1956 to 1959.

Mr. Zollman's early consulting services for the design and construction of pretensioning plants throughout the United States, his activities in the field of precast concrete as well as his many contributions to the PCI, have identified him as a pioneer of this industry in North America.

Mr. Zollman was a student of Professor Gustave Magnel at Ghent University, Belgium. Later, he became Magnel's unofficial representative in the United States, responsible for the detailed arrangements of Magnel's several trips to this continent.

In tribute to Mr. Zollman's years of service to PCI, and to his pioneering efforts in prestressed concrete, as well as his continuing interest in design and construction with precast and prestressed concrete, he was awarded the PCI Medal of Honor in 1979.

the long term, behavior of prestressed concrete structures. But they were wise enough to be careful in their endeavors.

This enthusiasm led to the construction of the Walnut Lane Bridge (Fig. 1),

as recounted in Part 1, which set the stage for later developments. It established once and for all that the concept of prestressed concrete was sound. But it also became apparent that, regardless of its merit, the concept could not be used extensively on this continent in its European form—as such, it was simply not competitive with other available materials.

The reason was that European and American construction philosophies were diametrically opposed. In the former, each engineering project was primarily considered as a custom-made venture, with the amount of labor only secondary; the strength of the latter was the assembly-line procedure which has yielded such dramatic economical results in a myriad of other American enterprises.

Professor Magnel recognized this difference in philosophy when he stated, in 1954, at the Canadian (Toronto) Conference on Prestressed Concrete:

“... In the United States, industry is developed in a wonderful way ... This is due in part to an internal market of 160 million people ... This has made possible the enormous development of mass production and the introduction of highly specialized labor saving machinery ... Unfortunately, in bridge building, one cannot apply the idea of mass production ...”

For once Professor Magnel was wrong. He underestimated American ingenuity, power and capabilities. What he thought was impossible—namely, assembly line mass production of pretensioned structural elements capable of carrying heavy loads over large spans—came to pass, even while Professor Magnel was expounding his ideas. But, in his defense, remember that the Professor was educated, lived and worked in Belgium, about the size of the State of Rhode Island and Maryland combined, where everything was on a small scale.

To him, pretensioning meant bond by the smooth, 2 mm (0.079 in.) maximum diameter wires then in use in Europe. It was applicable only to relatively short members such as small joists and planks, to carry light loads, i.e., roof loads. Grinning ear to ear, with a twinkle in his eye, he would state: “I cannot get excited about ‘toys.’ I think of the use of prestressed concrete in terms of large civil engineering projects.”

The Catalysts

As narrated in Part 2, the key to plant production of pretensioned structural elements which could carry substantial loads was the development of the 7-wire strand. It was the tool for which daring, imaginative and creative engineers and builders were waiting, so that they could jump into the fray.

Before builders could even realize what was happening, pretensioned structural members were already being conceived, designed, and produced in such widespread areas as Pottstown, Pennsylvania (Part 2), Florida (Part 3), Colorado (Part 6), and New Orleans, by men ferociously zealous of their independence, such as Ben Baskin, Ross Bryan, Harry Edwards, the Perlmutter brothers, Walter Blessey, and Arthur Anderson.

Each of them was paddling his own canoe with no, or at best very little, contact with each other, their concerns limited to their own marketable areas of about 100 to 150 miles (160 to 240 km) wide.

But where and how did these widespread activities originate? What were the common threads? What were the catalysts?

The only production vehicle all these men had in common was strand manufactured specifically for use in prestressed concrete work. Before 1952, only two firms in the world produced



Professor Gustave Magnel

such strand, John A. Roebling's Sons Company of Trenton, New Jersey, and United States Steel Corporation of Pittsburgh, Pennsylvania.

About 1952, they were joined by Union Wire Rope Company of Kansas City, Missouri (Part 5), now known as Armco Steel Corporation, but only after much of the basic development work had been completed by Roebling and U.S. Steel. Armco started then and has continued to this day, a successful research and development program of its own.

As the years went by, through continuing costly in-house research and development programs and improved metallurgical controls, these firms developed larger strands, up to 0.6 in. (15.2 mm) diameter. They increased their tensile strengths up to 270 ksi (1862 MPa) and improved other physical properties of the strands, such as their creep characteristics. In addition, incidental equipment, such as the reel-less center pullback, was developed.

Eventually, these high quality wire products were duplicated by wire manufacturers throughout the world: indeed, strands made specifically for prestressed concrete work has been a substantial American contribution to the world.



Walter Blessey

During this time, the sensitivity to corrosion of cold drawn wires became a very controversial topic. Walter O. Everling, director of research at United States Steel, an expert on the behavior of wires and strands in their highly stressed conditions, contributed greatly to finding, through research, an answer to this problem.

However, before narrating the swift expansion of prestressed concrete construction once strands were available, and the men who developed it, we must pause and describe prior prestressed concrete work related to foundations, that is, cylindrical prestressed concrete piles of unusual great length.

Cylindrical Prestressed Concrete Piles

Few are aware that it was in Louisiana that revolutionary pile foundations concepts were developed, tested and used. These were to be vital to the subsequent construction of off-shore drilling platforms and to precast prestressed concrete bridge trestle construction.

In the late forties and early fifties, Walter Blessey was professor of Civil Engineering at Tulane University in New Orleans and part-time independent consulting engineer.*

As early as 1946, Walter Blessey became concerned with prestressed concrete through an unusual set of circumstances. Among his New Orleans friends from his university days at Tulane was Henry LeMieux, a district manager of the Raymond Company for the Louisiana area in the late forties and early fifties.† At that time, Henry LeMieux's work was predominantly in the field of foundations: in New Orleans, this means primarily friction piles.

He worked closely with his chairman of the Board, the late Maxwell Mayhew Upson who, as early as 1939, instigated the fabrication and driving in New York City harbor of prestressed concrete piles. Upson had wanted to test the resistance of prestressed concrete to the deteriorating actions of brackish water or sea water, particularly in the vulnerable areas between high and low tide.¹ As a keen businessman he obviously had in mind their use in Louisiana where there was a high volume market for piles.

It was only natural for Henry LeMieux to interest Professor Blessey in prestressed concrete and to take advantage of Tulane's testing facilities for research on prestressed concrete piles.

Maxwell Upson was a most unusual, forceful and dynamic engineer who became interested in concrete as far back as 1905. He was proud to have had a part in the organization, in 1905, of the National Association of Cement Users, which later became the American Concrete Institute.

Upson participated in the organization's first convention, held in Indianapolis, Indiana, in January, 1905. All who attended this convention were aware of the inherent basic weakness of concrete, and reinforced concrete as

*Today, Professor Blessey is head of the Engineering School at Tulane University, New Orleans. In 1979 he served as president of the American Society of Civil Engineers.

†Today, Henry LeMieux is chairman of the Board and president of Raymond International Inc., successor to the old Raymond Concrete Pile Inc.



Maxwell Mayhew Upson (left) and Henry LeMieux.

well (i.e., its lack of tensile strength), which has been the subject of considerable discussion and experiment since the beginning of this century.

Not until Upson's first trip to Europe in 1937 was his attention called to Freyssinet's use of high strength cold drawn wires, which, through prestressing, could compensate for concrete's lack of tensile strength and, at the same time, take into account shrinkage and plastic flow of concrete through prestressing. From a technical viewpoint, Upson was convinced that it was the ideal remedy for concrete's weakness. Nevertheless, he also realized that prestressed concrete production in the United States would be limited until economic methods of operation could be devised. This was not to happen until the advent of the 7-wire strand, about 15 years and one World War later.

On his 1937 trip, Upson met the Count De Lubersac, general manager and executive officer of the prominent French contracting firm Campenon-Bernard to whom Freyssinet himself was the exclusive consultant. This firm held all the Freyssinet patents for prestressed concrete, such as the Freyssinet cone, jack and flatjacks. The friendship and business relationship between the Count and Upson which began then culminated in three important events:

First, Raymond's Director of Research, A. E. Cummings, organized in 1944 the ACI-ASCE Joint Committee 323 (since changed to 423) for Prestressed Concrete and remained its chairman until his untimely death in 1955.

Second, Raymond sponsored, about 1946, the beam tests at Tulane University under Walter Blessey.

Third, Raymond Concrete Pile (Count De Lubersac and Upson), in joint venture with Corbetta Construction Company of New York, submitted a bid on the alternate design for the Walnut Lane Bridge, as described in Part 1.

Although Preload's bid was accepted, the joint venture's submittal effort whetted further Raymond's appetite for prestressed concrete work. They returned to the competitive arena of prestressed concrete with a passion, and accelerated their research and development work in connection with the extra-long 54-in. (1.37 m) diameter prestressed concrete hollow piles. These piles were subjected to intensive tests running over a period of years before they were used on actual projects.

The manufacture of these piles was based on the assembly, through prestressing, of a number of centrifugally cast pipe sections, each 16 ft (4.9 m) long. The cast sections were held to-

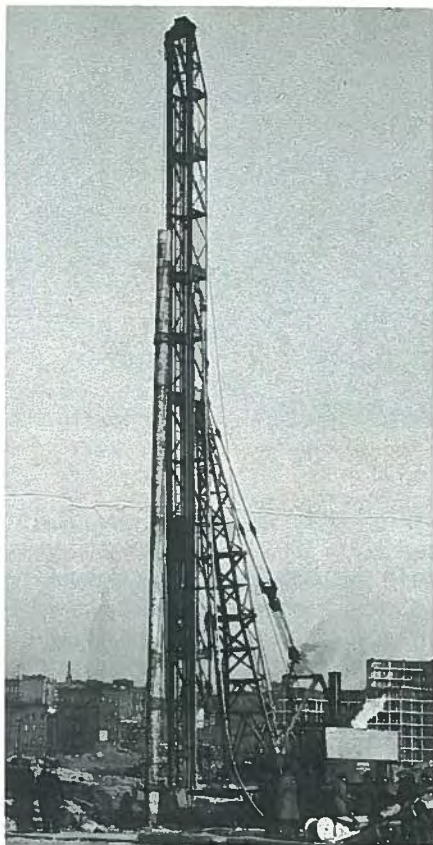

Fig. 2. Experimental prestressed cylindrical pile being driven in 1948 in New York City by the Raymond Concrete Pile Company.

gether by post-tensioning using temporarily reusable Freyssinet steel anchorages for which Upson had secured the patent rights in the United States. These special anchorages were removed after pressure grouting permanently bonded the wires (or strands) to the concrete surrounding them.²

Here again, a twist of fate! I became acquainted with Walter Blessey and Henry LeMieux in 1952 when, as a member of the Vacuum Concrete Inc. organization, I was the "expert"* on job-site precasting and vacuum lifting for the construction of precast concrete

warehouses and other similar structures in the New Orleans area. General contractor Bill Hogan used Raymond piles which were furnished through the offices of Henry LeMieux; Walter Blessey was the consulting engineer.

Thus, when Professor Magnel came again to the United States in 1954, I arranged for him to meet with Professor Blessey and the Raymond engineers. I still vividly remember the luncheon at the International House in New Orleans when Professor Magnel discussed with Raymond engineers their cylindrical pile.

He gently chided them for using (at that time) oil-tempered wires for the stressing of their pipe instead of cold drawn wires and for using such thin [4 in. (102 mm)] pipe walls, which only minimally protected the wires from corrosion, particularly in brackish or salt water. He believed that this construction method would only lead to controversy and turmoil. Had they paid attention to him then, they would have spared themselves considerable annoyance and expense.

"If prestressed concrete can be competitive only because of the use of thin walls and inappropriate materials, for heaven's sake, don't you use it." These were Magnel's parting words and they still ring in my ears. Prestressed concrete should not be used for its own sake, but rather only on a sound and rational engineering basis.

Cylindrical Pile Applications

Fig. 2 shows an experimental prestressed cylindrical pile being driven by Raymond International Inc. in 1948 in New York City. Fig. 3 is a close-up of a similar 96-ft (29.3 m) long, 54-in. (1.37 m) diameter pile being driven in 1953, in Lake Pontchartrain. The practical use of these piles was demonstrated in 1950

*"Expert" has been variously defined as "the man from out of town" or "the man who knows less and less about more and more." However, Webster defines him "as the one who has a special skill or knowledge in a subject, i.e., a specialist . . ."

with the construction of a precast deck for an off-shore oil treating and control station in the Gulf of Mexico standing on piles 36 in. (0.9 m) in diameter and 95 ft (29.0 m) long (Fig. 4).

These structures were followed by unusual designs and untried construction methods for the large precast prestressed superstructure for the approximately 24-mile (38.4 km) long Lake Pontchartrain crossing. The consulting engineering firm of Howard, Needles, Tammen and Bergendoff (HNTB) was selected in 1951 to develop feasibility studies for this crossing.

At that time I worked for HNTB, and developed three alternate precast prestressed designs with comparative cost estimates. One of these designs, in modified form, became the one used for the crossing. The continuing interest of HNTB in prestressed construction originated with that project almost 30 years ago.

For the first time in engineering history, the bridge consisted of one-piece precast deck units, i.e., of breadth equal to the bridge width except for the aluminum handrail and of length equal to the span. These units were barged to the causeway site and erected as shown in Fig. 5. The casting yard was at the lake's edge at Mandeville, Louisiana. An aerial view of a portion of the causeway showing the turn-around "in the middle of nowhere," is shown in Fig. 6.

Maintaining their momentum, Raymond, in joint venture with other firms, built the "7th wonder of Engineering"—the Chesapeake Bay Tunnel-Bridge, linking Cape Charles, Virginia to Norfolk, Virginia. Again, novel imaginative construction methods were developed by the Raymond engineers and their joint venture associates. Fig. 7 shows the erection of the precast prestressed bridge deck units consisting of pairs of girders integrally cast with the concrete deck slab (looking like a huge sturdy channel slab) spanning the 75 ft (22.9 m) which was the bridge span.



Fig. 3. Close-up of the driving of a 96-ft long 54-in. diameter cylindrical pile in 1953 for the Lake Pontchartrain Causeway. Note special driving bonnet which had to be engineered.

They altered and enlarged the plant where the components for the Tunnel-Bridge had been produced and turned it into a huge and versatile precasting and prestressing plant at Cape Charles, Virginia, which still today is in operation serving the Delmarva Peninsula.

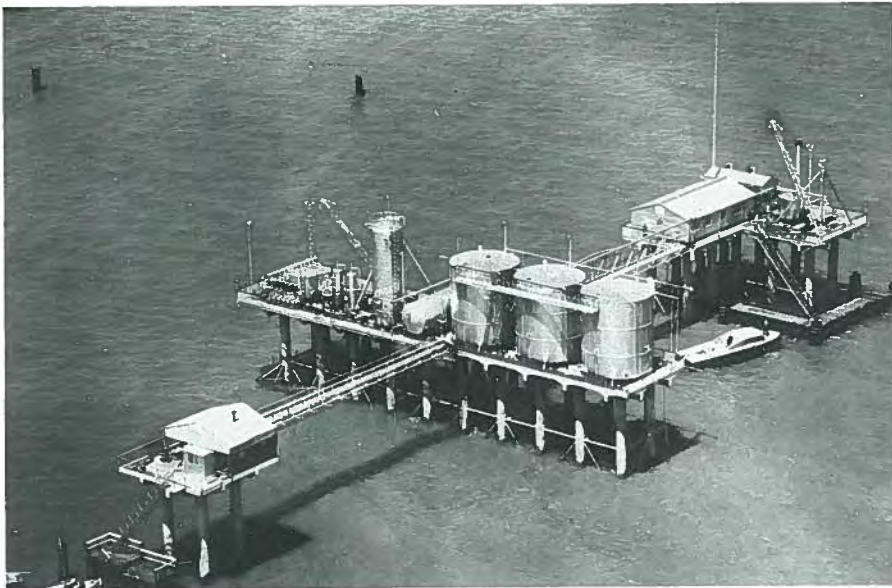

Fig. 4. Offshore Oil Structures in the Gulf of Mexico constructed in early 1950, showing cylindrical piles and precast deck unit.

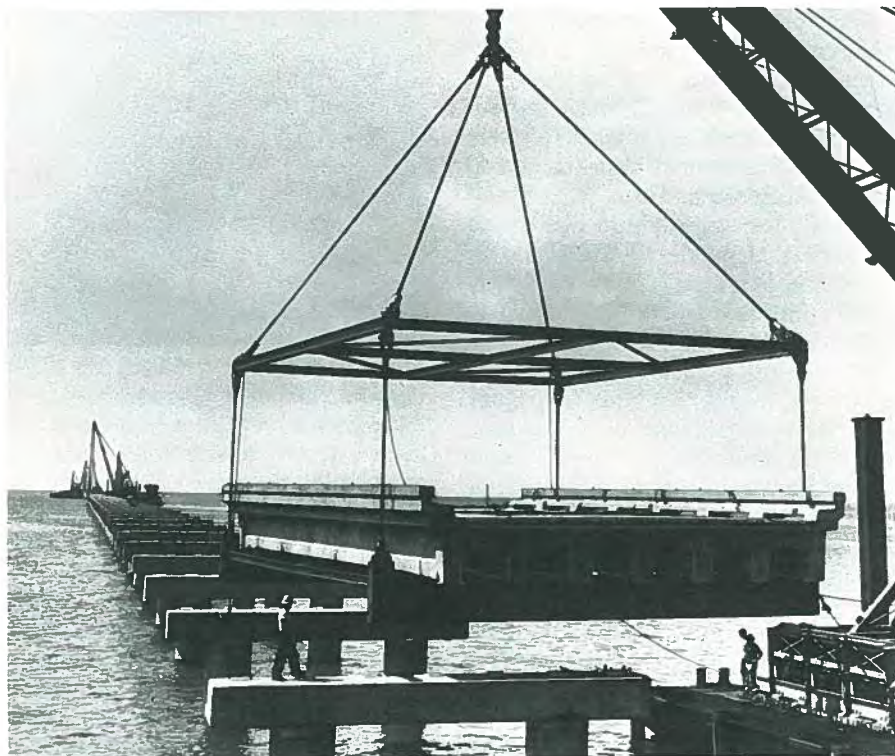

Fig. 5. Erection of completed deck for Lake Pontchartrain Causeway.

The mammoth, 135 ft (41.1 m) precast prestressed girders for the Jamaica Bay crossing in Long Island, New York, were produced in that Virginia plant and barged to New York by way of the Atlantic Ocean, a distance of close to 300 miles (480 km). The erection of such a girder is seen in Fig. 8.

The mind boggles not only at the amazing interlocking of the various worldwide international and national interests—wheels within wheels—but at the imagination, daring and ability of the early American prestressed concrete engineers and builders. Obviously, Upson and his engineers exerted an extraordinary influence in American prestressed concrete trestle construction.

Blessey's Early Research

In his dual capacities as Professor at Tulane University and independent consulting engineer, and prompted by Henry LeMieux and Upson, Walter Blessey

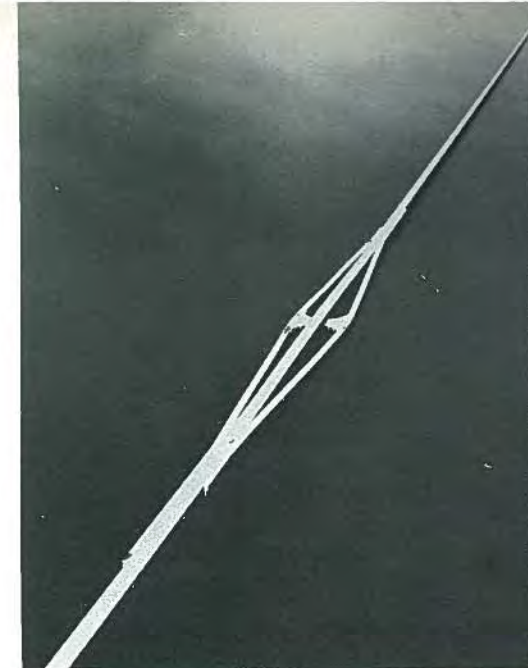

Fig. 6. Turn-around portion of Lake Pontchartrain Causeway — in the middle of nowhere.



Fig. 7. General view of erection of a span to be part of the Chesapeake Bridge-Tunnel Crossing connecting Cape Charles to Norfolk, Virginia.



Fig. 8. Erection of 135-ft long precast prestressed concrete girders barged from Cape Charles, Virginia to Long Island, New York, a distance of about 350 miles, for the Cross Bay Boulevard Bridge Jamaica Bay, N.Y. Crossing. Owner, Triborough Bridge and Tunnel Authority.

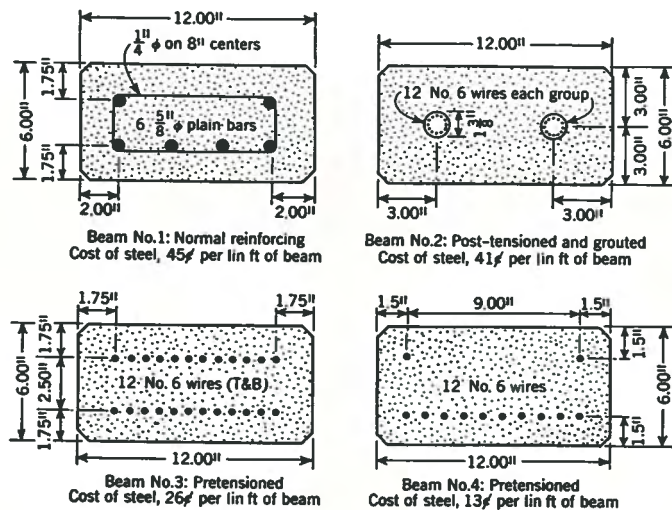

Fig. 9. Concrete beams, reinforced as shown, were tested to determine strength-cost relations. All wires of prestressed beams were M. B. oil-tempered, with a yield point of 170,000 psi, and an ultimate strength of 210,000 to 220,000 psi. Initial prestress was 150,000 psi. The $\frac{5}{8}$ -in. reinforcing bars were standard.

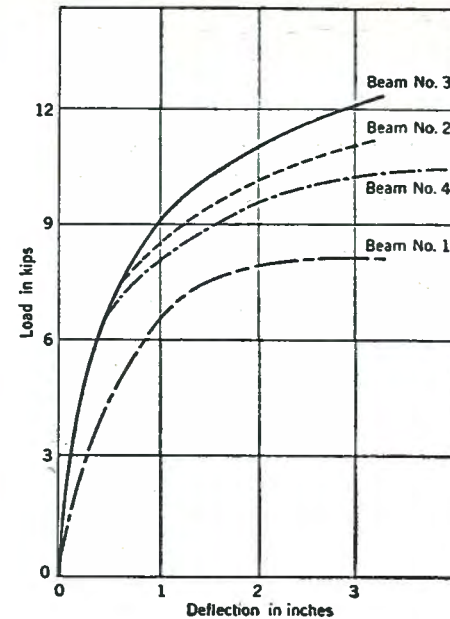

Fig. 10. Comparison of load-deflection relationship of four test beams (Tulane University).

conducted full-scale research on beams and prestressed concrete piles as early as 1946. His tests gave them the necessary data to proceed with their pile program, 33 years ago, long before most American engineers even had an inkling of what prestressed concrete was all about. Four types of sheetpiling were designed with different reinforcement and various types of prestressing using oil-tempered(!) wires.

Twelve beams, three each of the types shown in Fig. 9, were subjected to bending tests in the Engineering Department of Tulane. Under the direction of Blessey, these were tested as simple beams over a free span of 12 ft (3.66 m) with the loads applied at the third points.

Strain-gage readings were made at various places, and the strain and deflection in each beam were measured. The relationship between the load and deflection for each of the four types is shown in Fig. 10. The curves represent the average of the three specimens of each type.

Blessey subsequently tested the bond characteristics (Fig. 11) of the newly developed $\frac{3}{16}$ -in. (4.76 mm) diameter

Fig. 11. Strands were perfectly bonded to the concrete, as disclosed in this photograph. There is no slippage of the strands in the concrete, and the bond of the steel to the concrete was excellent. By turning this illustration upside-down, the strands can be seen—an optical illusion.

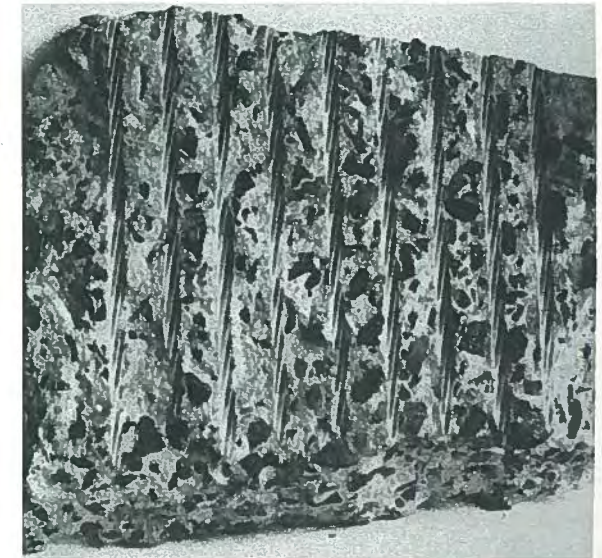

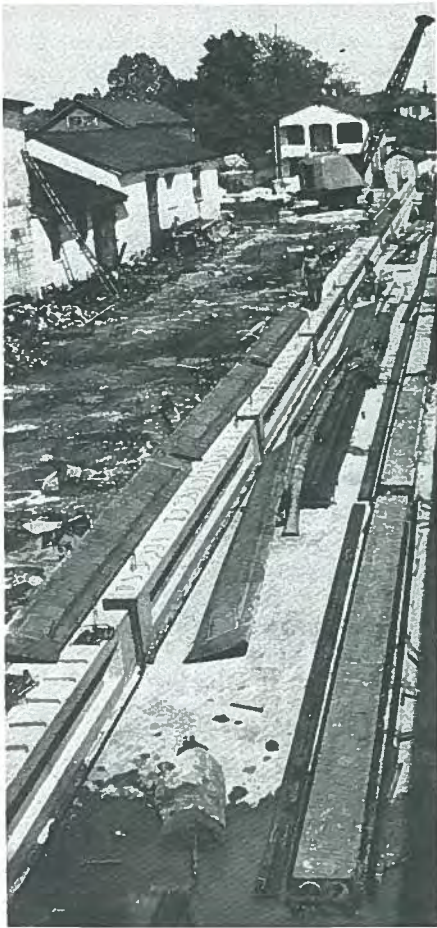

Fig. 12. Pretensioned bonded "I" section girders at casting plant in New Orleans for the production of girders for Loyola University's stadium about 1953.

strands.³ I believe that Tulane University's Reinforced Concrete Laboratories were the first non-commercial facilities to experiment with strands.

Based on his laboratory findings, Blessey designed for contractor Bill Hogan, about 1953, a single long line pretensioning facility (Fig. 12) for the production of pretensioned girders for Loyola's new stadium.* Concrete steps were cast on the girders in the plant (Fig. 13) to support precast reinforced

vacuum-processed concrete channel slabs to be used as seats. Panels were stripped by means of the vacuum lifter (Fig. 14). This structure is one of the earliest applications of the prestressing concept to building components.

Walter Blessey combined pioneering laboratory work with his practical field work. His early use of strands on a long line production basis were an inspiration for many, showing the way to the late Bob Belden, who constructed the first permanent prestressing plant in the New Orleans area. At first, he produced building components; later he produced bridge girders and eventually components for the Gulf of Mexico oil drilling platforms.

The Roebling Tradition

The name "Roebling" is charismatic to many of today's bridge engineers and builders and brings to mind the legendary John A. Roebling, founder of the John A. Roebling's Sons Company.

John Roebling conceived the revolutionary, classic Brooklyn Bridge, a suspension bridge with a span of 1600 ft (488 m). This structure, about twice the span length of the longest suspension bridge built up to that time, was possible because he used, for the first time, high strength steel wire rope, with an ultimate strength of 160,000 psi (1100 MPa). For the previous three longest suspension bridges he had built (the longest span was 1000 ft or 305 m), he had had to use wrought iron cables of about one-half the strength.

As legendary is the drama of Washington A. Roebling, John's son.

*I will forever be grateful to Walter Blessey for the assistance and advice he gave me when I had to design, in 1955, my first pretensioned installation, to be built in Savannah, Georgia, for contractor Diamond Construction Company for the manufacture of "aeons" of feet of 2 ft (0.61 m) square piles (with voids) about 80 ft (24.4 m) long for a State of Virginia Bridge. They were to be barged from Savannah, Georgia, to Virginia—quite an undertaking in 1955!

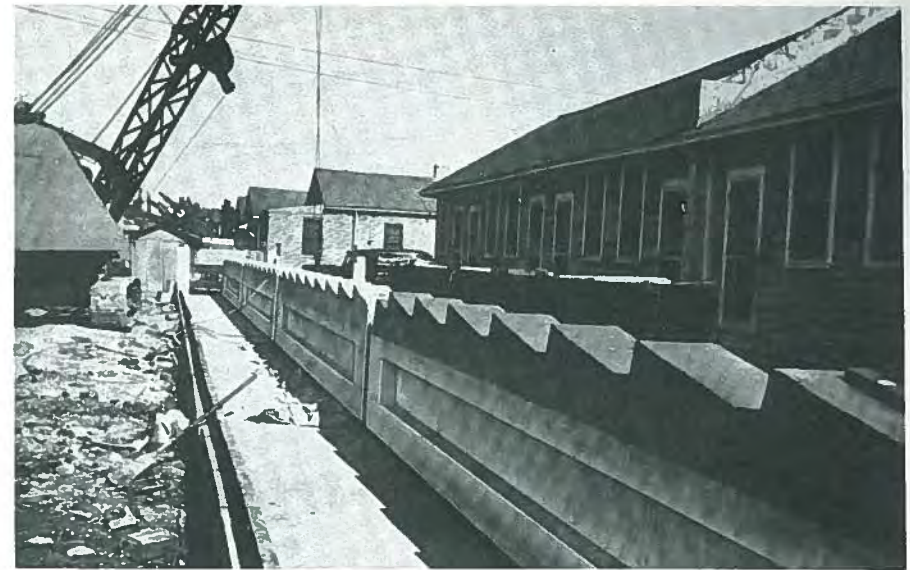

Fig. 13. Pretensioned girders of Fig. 12 with concrete steps cast on top. These finished girders were used to support precast vacuum processed seats in Loyola University's stadium.



Fig. 14. Vacuum lifter in action raises and removes precast non-prestressed channel seats from the molds for later use in Loyola University's stadium. This structure is an early example of the combined use of prestressing with precasting techniques.



John A. Roebling



Washington A. Roebling

Paralyzed by the "bends"* after having spent 12 consecutive hours under compressed air in a pier caisson, he had to withdraw to his apartment overlooking the Brooklyn side of the bridge, a helpless invalid. However, although unable to leave his room, he directed the construction by remote control from his bed, watching with field glasses and relaying his orders via his wife. The stricken engineer tenaciously brought the bridge to completion in 1883, after 14 years of construction.⁴⁻⁶

The Brooklyn Bridge would serve as the model for such titans as the George Washington Bridge, the Golden Gate Bridge, and the Verrazano-Narrows Bridge, the latter having a span from tower to tower of 4260 ft (1300 m).

The example of extraordinary ability, dedication and courage set by John and Washington Roebling remained long after the construction of the Brooklyn

Bridge. It motivated all those in contact with them to accomplish great things. Their successors at the firm and workers for generations to come were influenced by the memory of the mastery of the two men. It brought out their best and created a pride in high quality work which became compulsive within the Roebling firm.

The Gentleman Innovator

Thus, it is understandable that the great Charles C. Sunderland, chief bridge engineer at Roebling for many years, until his death in 1952, would follow the example set by the Roeblings. As a result, the products Roebling developed, such as high strength wire rope, galvanized fittings, saddles, and so forth, became synonymous with high quality. They were not always the most economical items on the market place; but they were some of the best products money could buy.

Although he was basically a structural steel oriented engineer, Sunderland delved into prestressed concrete shortly after its practical use was introduced in

*"Bends" or caisson disease is caused by nitrogen bubbles forming, especially at joints, after working in compressed air without having followed the rigid decompression procedures instituted to prevent the bends.

Europe about 1939 when Freyssinet built his Luzancey Bridge in France. By 1944, L. Coff, an independent consulting engineer in New York with Austrian engineering training, knowledgeable in the use of high strength wire rope, had caught Sunderland's imagination by describing European developments in prestressed concrete. A man of vision, Sunderland became thoroughly convinced of its potential in the United States, and foresaw an expanded market for high strength wires, wire ropes, and related fittings.

He succeeded in convincing the Roebling management that a reasonable amount of money should be invested in research which would lead to development of technical know-how at job sites, and to development of materials and equipment especially designed for prestressed concrete construction. Sunderland ran, in Roebling's laboratory, the full gamut of the design and casting of 1-in. (25.4 mm) thick prestressed concrete planks, to demonstrate the flexibility and "rebound" of the material. Also cast and tested were springboards, columns, beams made up of concrete blocks, and models developed for prestressed concrete box girder bridges. This R&D work ultimately produced the American prestressing system known as the Roebling Post-tensioned system.⁷

By 1945, Sunderland was ready to manufacture the steel components for his system, such as wires, galvanized wire rope, cast saddles, and end fittings, on a production line basis. He did not end his R&D program, however, but continued his search for better and more economical products, enjoying immensely the challenge of his work.

In a March 16, 1945 report, Sunderland reviewed the past activities of the Roebling firm in prestressed concrete, predicted the potential future market, and also requested additional funds for research and promotional work in this field. He predicted that prestressed concrete would soon become a standard



Charles C. Sunderland

material for the manufacture and assembly of single and multiple story buildings, bridges, airport runway slabs, and highways—in 1945, when only a handful of engineers knew the meaning of the words "prestressed concrete."

Eventually, Sunderland became known for his work in prestressed concrete, though he is probably best known for his innovations in suspension bridges and other cable-supported structures, such as a system of multiple stringing of wire in parallel wire suspension bridge cables which greatly increased the speed of stringing such cables.

"Roebling—Strands and Fittings for Prestressed Concrete" was, in 1951, the first prestressed concrete materials catalogue published in America. In 1955, a revised and expanded version, "Roebling—Tensioning Materials for Prestressed Concrete," was made available to the emerging industry. American Steel and Wire Corporation, a division of United States Steel, was not far behind, with Walter O. Everling as their driving force. In 1955, ASWC published a comprehensive catalogue, "American Super-Tense Wire for Prestressed Concrete—American High Strength Strand."

One of the earliest structures where such bridge strands and fittings were used was the 3-in. (76.2 mm) fill-supported jointless 150 × 100 ft (45.7 × 30.5 m) floor for one of Roebbling's Chicago warehouses.⁸ In service for many years, the floor slab has remained crackless under the concentrated heavy loads of wires on reels.

Stress-Relieved Wire

Shortly after the construction of the Chicago slab, Coff, under Sunderland's direction, developed the preliminary Roebbling designs for the Walnut Lane Bridge. Although Sunderland must have been extremely disappointed when Roebbling's design was rejected, he calmly and gracefully accepted the rejection, refusing to make an issue of the decision even when urged to do so. Instead, he said, "Well, we shall now proceed with the manufacture of a cold drawn wire with qualities second to none," and that is precisely what he did.

The stress-relieved, 0.276-in. (7 mm) diameter high-strength cold drawn wire was the outcome of Sunderland's commitment. The Walnut Lane Bridge was the first structure in the world to use such high quality wires. Even Professor Magnel commented, "Had I known that this kind of wire was available in the United States, I would have specified a much smaller number of wires for the Walnut Lane Bridge."

After that, a number of other post-tensioned structures were built using stress-relieved wires but, with the advent of 7-wire strand, the use of the 0.276 in. (7 mm) stress-relieved wire gradually ceased.

Canas River Bridge

Sunderland did not give up on his Walnut Lane design concept. He persevered in his efforts to build hollow-box concrete girder bridges utilizing Roebbling galvanized steel strands, and soon met with success: the design and construc-

tion of the Canas River Bridge, near the town of Trinidad, Cuba.

The bridge was designed by engineers of the structural section of the Comision de Fomento Nacional in Cuba in consultation with Roebbling engineers for all details connected with prestressing materials. Its concept, similar to Roebbling's Walnut Lane Bridge design, is shown schematically in Fig. 15. It was strongly influenced by Sunderland, whose skill and background in suspension bridge design and construction is apparent. Construction was completed in December, 1952 (Fig. 16).

It was the first hollow box to utilize galvanized steel strands, long a component of American suspension bridges. It is mentioned here because of its originality, and its application of suspension bridge concepts to prestressed concrete.

The bridge had the longest prestressed concrete span in the western hemisphere at the time of its construction. The center span is 294 ft 4 in. (89.7 m) long; cantilever end spans are 49 ft 8½ in. (15.2 m) each. Live load was equal to two H-20 lanes.

The cross section was hollow with 8-in. (203 mm) concrete walls, bottom and diaphragms. The top slab also served as the roadway.⁹

The structure was post-tensioned with 112 1-in. (25.4 mm) diameter galvanized strands anchored at the ends of the girder by tightening nuts on threaded swaged fittings. This strand size was used because it was available in stock and the Cuban engineers wanted to complete the post-tensioning before the rainy season floods: the structure was supported on falsework which would probably have been washed out.

For the construction of several subsequent hollow box bridges in Cuba, 1½ and 1⅞-in. (41.3 and 42.9 mm) diameter cable strands were used.*

*Professor Vande Pitte of Ghent University was to design and build, in the mid-fifties, several structural steel cable suspension bridges using prestressed concrete stiffening girders.¹⁰

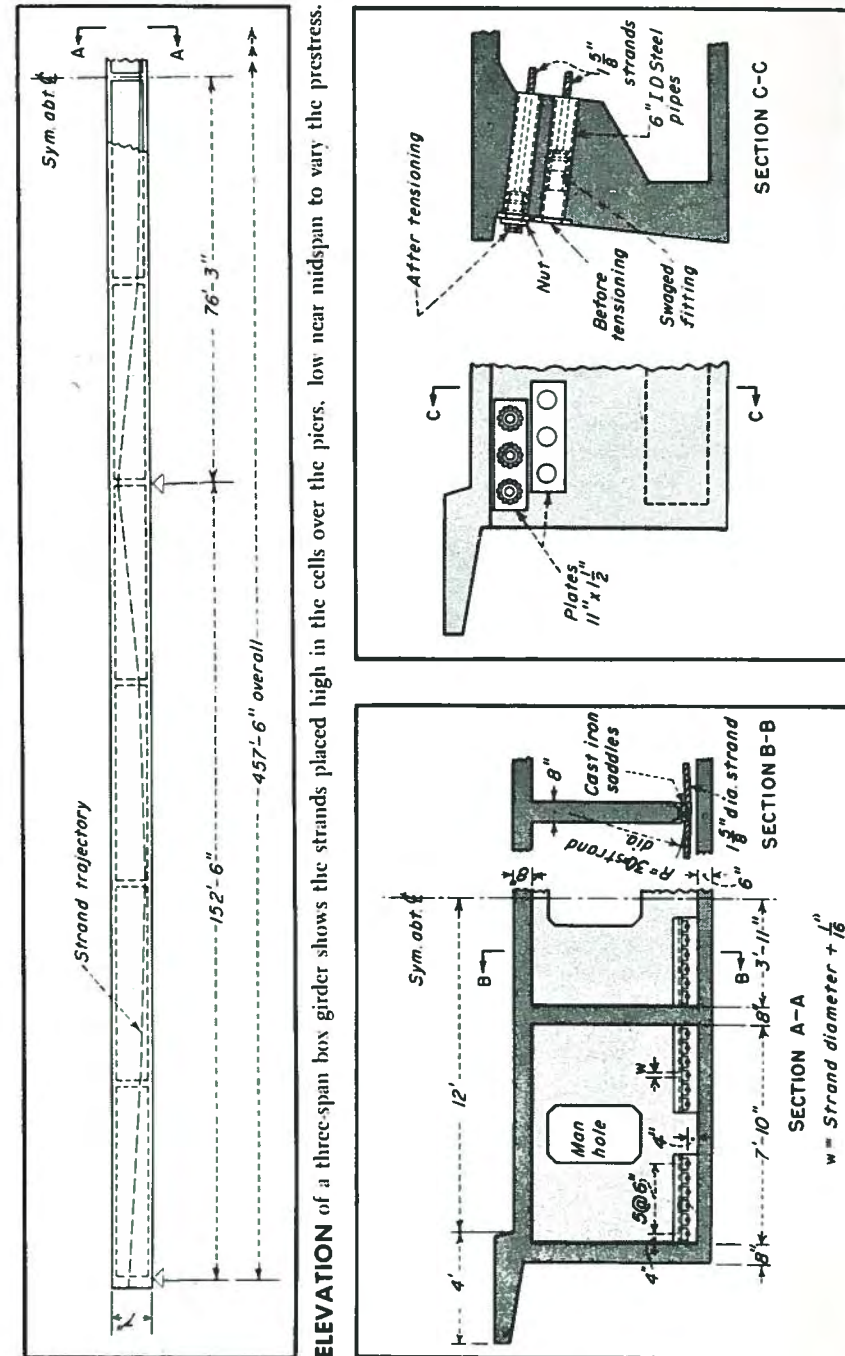

ELEVATION of a three-span box girder shows the strands placed high in the cells over the piers, low near midspan to vary the prestress.

AT GIRDER ENDS, tensioned strands pass through pipe sleeves in the end diaphragm and are anchored by tightened nuts. AT MIDSPAN, strands are held 4 in. above the bottom slab at the diaphragm to pass strand fittings under the saddles.

Fig. 15. Canas River Bridge, Cuba, showing the elevation and section details at midspan and at girder ends.

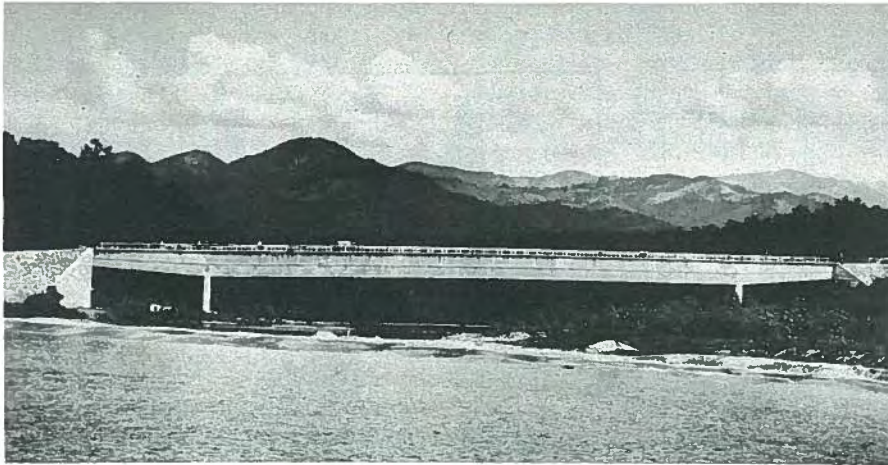

Fig. 16. Canas Bridge, first prestressed box girder in Cuba. It spans 249 ft and has 50-ft anchor arms. Later designs resulted in more economical construction details and architectural improvements such as arched soffits.

The Canas Bridge and three similar bridges were designed under Dr. Luis Saenz, head of the Comision, who left Cuba when Castro came to power and, after many years practice in Puerto Rico, settled near Miami. Mario Suarez, associated for many years with the Stressteel Corporation in Wilkes Barre, Pennsylvania, was in Dr. Saenz's design group. Cuba's loss was America's gain!

Stress-Relieved Strand

Sunderland was not a man to rest on his accomplishments. He next tried to manufacture a $\frac{5}{16}$ -in. (7.9 mm) strand out of stress relieved wires. This did not work because cold-forming the outside wires around the center wire destroyed most of the benefits of stress-relieving.

Howard J. Godfrey, chief metallurgist at Roebing, known to the industry as Hank, developed the successful procedure: making the strand from as-drawn wires and then stress-relieving the strand.¹¹⁻¹³ Hank, now retired, shared his knowledge unselfishly in many publications (See for example References 14-17).

The ultimate measure of a man is where he stands in times of challenge

and controversy. Charles C. Sunderland, a great and dignified engineer and a true leader of men, stood for progress and growth in the midst of the challenges and controversies of the fledgling prestressed concrete industry. It was Sunderland who taught prestressed concrete to such men as Kent Preston, Lloyd Hill and Pat Patterson, who subsequently made important contributions to the industry.

The Three Musketeers

Kent Preston was, at the time, chief product engineer of the Construction Materials Division of John A. Roebing's Sons Corporation.* Lloyd E. Hill and A. L. Patterson, the latter better known throughout the industry as "Pat," were sales engineers for the Division.

They worked under the competent, diligent and inspiring leadership of Forrest S. Burtch and J. Nelson Hicks. At that time, Burtch was the sales manager of

*Presently he is an associate of Wiss, Janney, Elstner and Associates, Inc. and a consultant to Florida Wire and Cable. He was chairman from 1976 to 1979 of PCI's Bridge Committee and also a member of AASHTO—PCI's Joint Bridge Committee.



H. Kent Preston



A. L. Patterson

the firm's Prestressed Concrete Wire Products Division and also the first chairman of PCI's Committee on Fire Ratings. Nelson Hicks was the business administrator of Roebing's Bridge Division from about 1944 to 1953, and as such did considerable of the early promotional work.†



Nelson Hicks, Lloyd E. Hill, and Pete Verna

During the time these men were active in the firm, Roebing was spending large amounts of money on research and development, trying to establish in the United States a market for wire products for prestressed concrete.

Inspired by the great Roebing tradition of quality, the three musketeers Preston, Hill and Pat undertook to educate¹⁸ and assist, to advise and encourage those Americans who, with vision, courage and imagination, ventured in the arena of prestressed concrete construction. Among the men who sought and received advice were: Ross Bryan in Tennessee, the Perlmutter in Colorado, many Florida producers, C. L. Johnson in Pontiac, Michigan, and many others including myself.

Advertisements concerning materials (Fig. 17) and completed prestressed concrete structures appeared regularly in prominent publications including *Engineering News-Record*, *Architectural Record*, *Architectural Forum*, *Civil Engineering*, and *Concrete* magazine, and later in the PCI JOURNAL. On several

†After leaving Roebing, Hicks became vice president of Stressteel, Inc., and for many years continued working in the area of post-tensioning.



We speak your language

The language of service and engineering assistance wherever and whenever you need them.

The reel of Roebling Stress-Relieved Strand for prestressed concrete that you see here is but one of many elements of prestressed concrete... every one of which Roebling is familiar with and many of which Roebling has instituted and developed.

Fourteen years of experience in every aspect of the prestressed concrete field—tensioning elements, strand development, design procedures, the develop-

ment and introduction of the stress-relieving process for the uniform behavior of tensioning wires and strands—enable Roebling to deliver much more than the strand on the reel.

This from the oldest manufacturer of wire rope in the United States: the highest quality stress-relieved strand delivered in a "package" you cannot get from any other source in the world.

ROEBLING
Special Office in Trenton, N. J.
 Subsidiary of The Columbia Steel and Iron Corporation

Fig. 17. Typical Roebling advertisement which ran in various national publications during the fifties to sell their stress-relieved strand.

occasions, full page advertisements paid for by Roebling ran in the prestigious *Wall Street Journal*, to coincide with convention meetings.

Kent Preston and his associates wrote technical papers on design, construction and costs, such as Roebling's "Design Procedure for a Simple Span Prestressed Concrete Beam," issued as early as March, 1953. Fig. 16 illustrates the July 18, 1955 net price list of Roebling's strands for prestressing.

The Roebling men also shared their experience and knowledge through participation in conventions, seminars and short courses. Who does not remember with delight and nostalgia Roebling's hospitality rooms at conventions? There, in a relaxed atmosphere, many ideas germinated or were exchanged, and dreams and aspirations for a bright future for the industry originated; and there we let our hair down—sometimes ready for mischief after the tensions of the day!

But above all, Preston, Pat and Hill visited the producers on their home grounds, travelling far and wide to plants

where the problems were. The "Three Musketeers," criss-crossing the United States from north to south and east to west, were the dedicated trouble-shooters of the industry.

In retrospect, I dare say that, without their hard work, dedication, and professional and business integrity, the industry would not have developed so rapidly in the early fifties.

REFERENCES

1. Upson, Maxwell M., "Prestressing Warrants Study to Simplify Construction Methods," *Civil Engineering*, January 1953.
2. Waddell, Joseph J., "Prestressed Concrete for World's Largest Vehicular Bridge," *Concrete Products*, April, 1956.
3. Abbett, *American Civil Engineering Practice*, V. III, John Wiley & Sons, Inc., 1957, p. 25-07.
4. Silverberg, Robert, *Bridges*, Macrae Smith Company, Philadelphia.
5. Steinman, D. B., *The Builders of the Bridge*, Harcourt, Brace and Company, Inc., New York, 1945.
6. McCullough, David, *The Great Bridge*, Simon and Schuster, New York, 1972.
7. Sunderland, C. C., and Preston, H. Kent, "Americanized Prestressed Concrete Emerges from the Laboratory," *Engineering News Record*, March 2, 1950.
8. "Prestressed Concrete Floor Slab Completed in Roebling's Chicago Warehouse," *Engineering News Record*, January 6, 1949.
9. Preston, H. Kent, "Design of Prestressed Hollow-Box-Girder Bridges," *Engineering News Record*, December 27, 1956.
10. VandePitte, M. Daniel, "Le Pont Suspendu en Beton Precontrainte," *La Technique des Travaux* (Belgium), July-August 1957.
11. Preston, H. Kent, "Wire and Strand for Prestressed Concrete," *Civil Engineering*, June 1956.
12. Preston, H. Kent, "Proper Use of Wire and Strand in Prestressed Concretes," *PCI JOURNAL*, V. 2, No. 3, December 1957, pp. 18-20.
13. Kasten, R. O., "7-wire S. R. Strand Crosses Lake Pontchartrain," *PCI JOURNAL*, V. 1, No. 1, May 1956, pp. 33-37.
14. Godfrey, Howard J., "Methods of Testing Prestressed Concrete Strand," *PCI JOURNAL*, V. 1, No. 3, December, 1956, pp. 38-47.
15. Godfrey, Howard J., "Corrosion Tests on Prestressed Concrete Wire," *Corrosion Magazine*, April 1961.
16. Godfrey, Howard J., "Steel Wire for Prestressed Concrete," *Proceedings*, First U.S. Conference on Prestressed Concrete, Massachusetts Institute of Technology, Cambridge, Massachusetts, 1951.
17. Godfrey, Howard J., "Stress Corrosion and Relaxation of Steel and Prestressed Concrete," Conference on Prestressed Concrete, University of Toronto, Toronto, Ontario, Canada, 1954.
18. Preston, H. Kent, *Practical Prestressed Concrete*, McGraw Hill, 1960, 335 pp. (First "practical" textbook aimed at the practising engineer rather than the college student.)

* * *

NOTE: Article continues in Part 9 (cont.), p. 308.

PRESTRESSED CONCRETE STRAND							
NET PRICES PER 1000 FEET							
7 WIRE UNCOATED STRESS-RELIEVED							
Strand Diam., Inches	Weight, Lbs. per 1,000 Ft.	Minimum Strength, Pounds	Up to 10,000 Ft.	10,000 Ft. to 75,000 Ft.	75,000 Ft. to 40,000 Lbs.	40,000 Lbs. Minimum Carload Shipment	Strand Diam., Inches
1/4	122	9,000	\$39.00	\$36.56	\$34.41	\$29.25	1/4
3/16	198	14,500	58.00	54.37	51.17	43.50	3/16
1/8	274	20,000	73.46	68.87	64.82	55.10	3/8
1/2	373	27,000	96.13	90.12	84.82	72.10	1/2
1/2	494	36,000	124.80	117.00	110.11	93.60	1/2

OTHER GRADES AND CONSTRUCTIONS

7-Wire—Galvanized Prestressed Concrete Strand averages about 15% lower strength and is priced 10% higher than the corresponding size and quantity of 7 Wire Uncoated Stress-Relieved Strand listed in the above table.

Galvanized or Uncoated Strand Assemblies, complete with end terminals and encased in flexible tubing, if required, are available for all Post-Tensioning applications. Consult with the nearest Roebling District Office or with Trenton, N. J. giving full details of requirements.

Fig. 18. July 1955 net price list of Roebling strands for pretensioning.

The End of the "Beginnings"



Charles C. Zollman
Consulting Engineer
Newtown Square, Pennsylvania

"It is said that one machine can do the work of fifty men. No machine, however, can do the work of one extraordinary man."
Tehyi Hsieh, Chinese Epigrams, 1928

In the last issue, I described some early work with cylindrical prestressed concrete piles and traced the development of prestressing strand, especially by the pioneering Roebing engineers. I will now explain how *precast* concrete roof decking evolved into *precast prestressed* tee elements, and will discuss the resolution of some major problems which faced the infant prestressing industry. Among these were:

- Standardization of casting forms.
- Elimination of girder end block requirements and shear key requirements in composite construction.
- Acceptance of larger strand sizes.

- Bridge girder standards.
- Development and dissemination of prestressed concrete design criteria and the need for engineering design aids.

Evolution of Precast Concrete Roof Decking

In Part 3 of this series, Harry Edwards describes vividly his struggles with prestressed concrete in Florida. He was instrumental in the development of the basic double tee, at the very moment when the precast reinforced concrete panel industry was at a loss as to "where to go from here."

To understand the predicament in which the precast concrete industry found itself in the early fifties, it is necessary to relate some of the industry's background.

In this first continuation of the concluding paper, the author pulls together the various threads of history spun in previous parts of this series and fills in the gaps still left in the story of the early years of the precast prestressed concrete industry.

When World War II began in 1939, a substitute for steel roof decking and related components was needed. The only non-essential material available was concrete. Thus began the production of 3½-in. (88.9 mm) thick, 2-ft (0.61 m) wide reinforced concrete planks, with maximum spans of 8 to 9 ft (2.4 to 2.7 m); and of channel slabs, also 2 ft (0.61 m) wide, with legs 3½ in. (88.9 mm) deep, slab thickness of 1½ in. (38.1 mm) and a maximum span of 8½ ft (2.59 m) (Fig. 19, Items "a1" and "a2").

These elements were plant manufactured along assembly line procedures in places such as Birmingham, Alabama; Cleveland, Ohio (Rackle); and North Jersey (Porete), to name just a few locations. This was the state of the art by the end of World War II when structural steel once again became available for peaceful purposes. The competitive edge of the concrete plank and channel slab over that of steel elements gradually diminished almost to the vanishing point. To survive, the concrete industry developed the long span, 2-ft (0.61 m) wide reinforced concrete channel slab (Item "b" Fig. 19) by increasing the depth of the legs from 3½ in. (88.9 mm) up to 12 in. (305 mm).

Deflection limitations did not permit spans greater than 16 ft (4.88 m) for the 6-in. (152 mm) deep channel slab, 25 ft (7.62 m) for the 10-in. (254 mm) deep channel slab and 32 ft (9.75 m) for the

12-in. (305 mm) deep channel slab, depending on the roof load. Such channel slabs were developed and produced by the Formigli Corporation of Berlin, New Jersey, under the trade name of "Channel Crete."

However, in the American competitive market, the desire for a more economical product is always there. It was necessary to develop a member that could be used for either larger spans or increased width, to reduce the number of elements to be handled.

Arsham Amerikian showed the way. Now a consultant in private practice, he was at that time chief designing engineer of the Bureau of Yards and Docks, Department of the Navy, Washington, D.C. Amerikian developed and used, for his precast reinforced concrete U.S. Navy warehouses (Figs. 20 and 21), 5-ft (1.52 m) wide, 8-in. (203 mm) deep thin shell ribbed panels (Fig. 19, Item "c").¹⁹⁻²¹

Coincident with this development, and contributing to making these panels economically competitive, Karl Billner developed vacuum processing and the vacuum lifter.

Karl Billner was president of Vacuum Concrete, Inc. and holder of many patents related to precast and/or prestressed concrete construction. Amerikian and Billner were good friends; perhaps somewhat egotistical, but outstanding, practical-minded engineers.

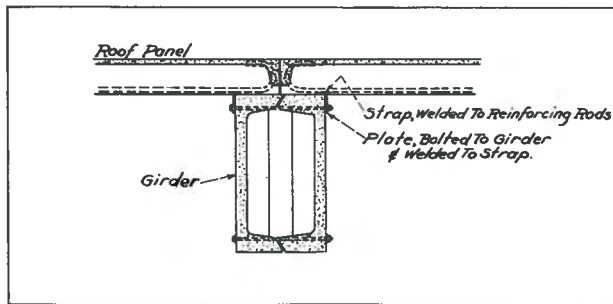
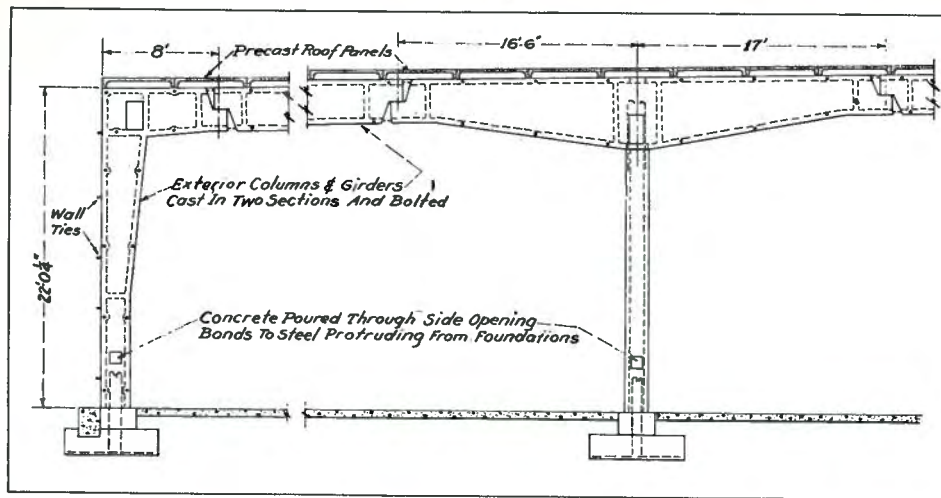

Methods employed in assembling and erection of precast warehouse framing are illustrated in these drawings.

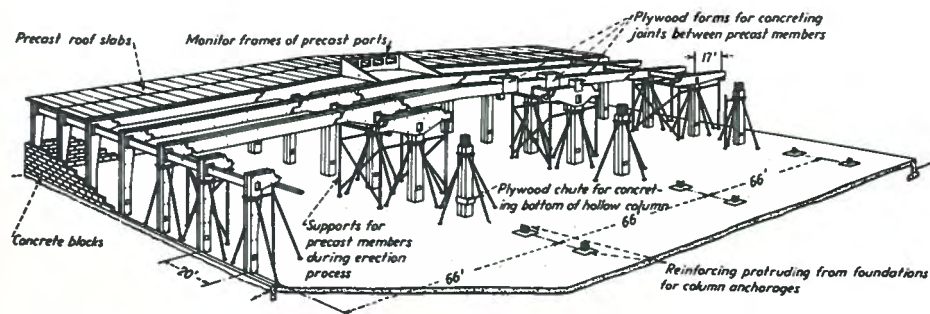

Fig. 20. Details for the construction of three bay U.S. Navy precast concrete warehouses in the late forties and early fifties.

Both were eager to make contributions to the engineering profession as designers and to the concrete industry as builders.

The vacuum process removed excess water from concrete after it was placed

in the forms, so that a completely "no-slump" consistency was obtained immediately, and high strength concrete was attained at the early age of 1 day. A vacuum pressure of mercury equal to $\frac{3}{4}$ ton/sq ft (71.82 kPa) forced suction mats

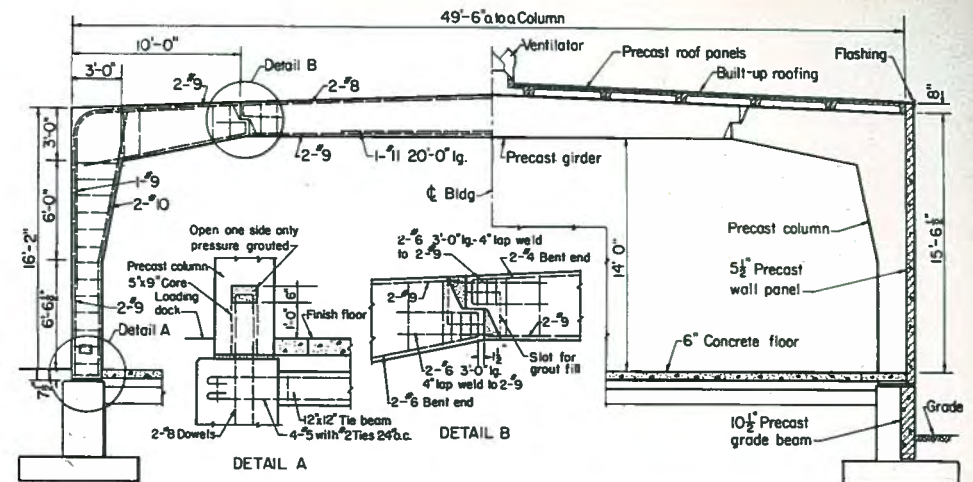

Fig. 21. Typical one bay wide precast concrete warehouse as designed and built for the U.S. Navy during the early fifties when the Navy's extensive construction program reached its peak.

against the wet, newly placed concrete, expelling the water and, in large measure, closing up the water voids (Fig. 22). There were no driers, admixtures or special cements of any kind in vacuum processing.

The vacuum lifter consisted of a stiffening frame (Fig. 23) which was attached to a precast concrete section utilizing atmospheric pressure. Fig. 24 shows the vacuum lifter in its upside-down position.

It was possible with the vacuum lifter to remove panels from their molds much sooner than with ordinary mechanical means. The use of the lifter resulted in an even distribution of stresses, eliminated the need for anchor bolts and special reinforcement, and eliminated concrete cracking.

Vacuum processing made it possible for the concrete to gain an early strength sufficient for the vacuum lifter to remove the element from its casting mold in one day with a concrete strength more than 4000 psi (27.6 MPa). These two tools made possible the daily casting cycles described in Reference 22 before the

advent of casting yard steam curing. These techniques helped American produce economical 5-ft (1.5 m) wide thin shell ribbed precast panels.

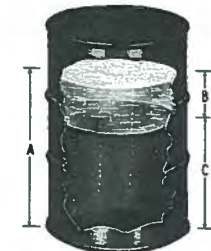

- A.—40 gals. of water used for typical cubic yard batch.
- B.—10 to 13 gals. removed by Vacuum-processing, resulting in 50% greater strength, and less absorption, shrinkage and wear.
- C.—27 gals. left after Vacuum-processing. Ample to hydrate the cement, but would never have made concrete plastic enough to place.

(Note: Above are approximate figures; will vary from job to job.)

Fig. 22. Principle of vacuum processing. This method made it possible for concrete to reach relatively high early strengths before the advent of casting yard oil and steam curing techniques.

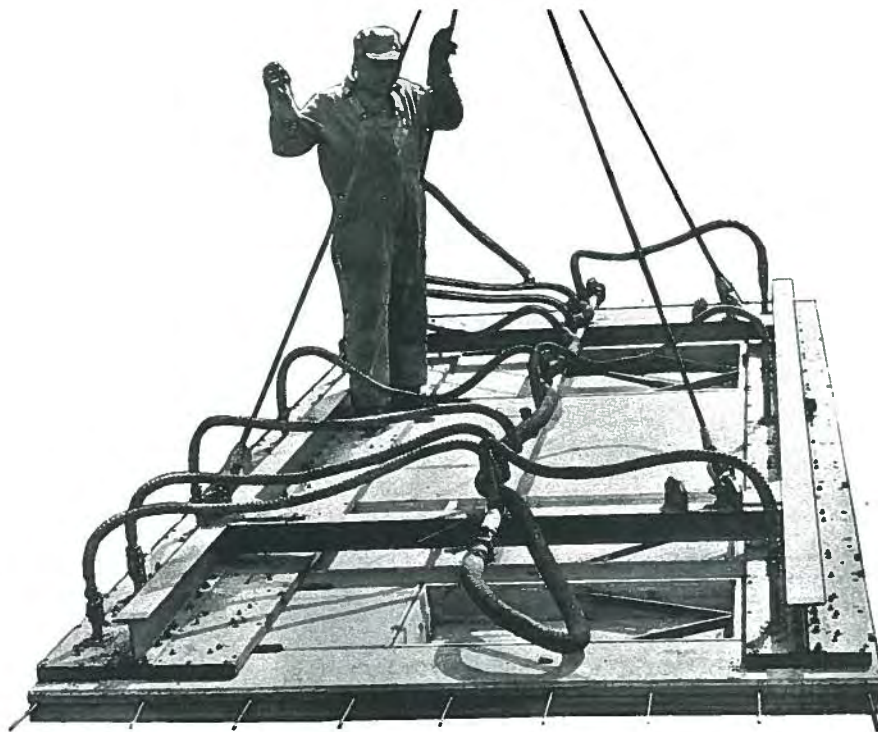

Fig. 23. Operating position of the vacuum lifter.



Fig. 24. Vacuum lifter used in 1953 for Loyola University's stadium seats in the upside down position. Note that the sponge rubber strips will be compressed by atmospheric pressure when a vacuum is applied between the lifter and the top of the slab. Thereby, the lifter pushes against the concrete panel sufficiently to allow it to be removed from the mold, just as a giant suction cup would.

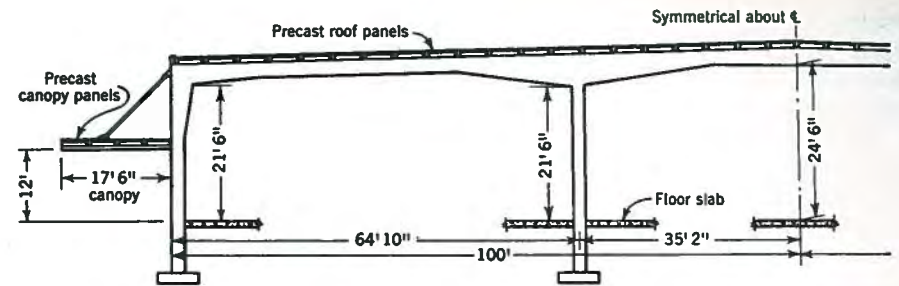

Fig. 25. Warehouse design is shown in one-half cross sections. Two basic building components are the cast-in-place rigid frames and the precast thin shell ribbed roof panels. In early fifties this framing method was used often for warehouses.

Detailed descriptions of assembly line precast construction techniques for these thin shell ribbed precast elements and the supporting precast concrete rigid frames appear in the *ACI Journal*.²³⁻²⁶ Of particular interest is Reference 22. This article describes the daily production of 272 thin shell ribbed roof

panels, 5 x 18½-ft (1.52 x 5.64 m). One enterprising contractor cast 140 such panels daily in about 200 working days (26,400 panels) for ten 230 x 1000-ft (70.1 x 305 m) warehouses (Figs. 25 and 26). A second casting yard, consisting of 132 molds, was set up on the same site by another con-



Fig. 26. Precast concrete installation at the U.S. Marine Corps Supply Depot in Albany, Georgia, 1952. One hundred and forty concrete molds permitted a daily production of 140 thin shell ribbed roof panels required for the 10 warehouses shown in the section above (Fig. 25).

tractor, for the casting of 18,480 additional panels in 140 working days, to build seven more warehouses, part of a second contract.

The client's demand for larger column free space was maintained. About 1952, the U.S. Army Corps of Engineers developed typical designs for the AMC (Air Material Command) warehouses to be constructed at such bases as Shelby, Ohio; Kelly Air Force Base in San Antonio, Texas; Warner Robbins AFB near Macon, Georgia; Tinker AFB in Oklahoma and the Mobile, Alabama AFB. These buildings were generally 400 x 2000 ft (122 x 610 m) in plan with clear bays of about 33 ft 3 in. x 66 ft (10.1 x 20.1 m) with cast-in-place reinforced concrete rigid frames in the 66-ft (20.1 m) direction. Cast-in-place reinforced concrete joists, 33½ ft (10.2 m) long, about 8 ft 3 in. (2.5 m) on centers were to receive the 2-ft (6.1 m) wide, 8-ft 3-in. long precast concrete deck planks.

There were thousands of components to be handled and joints galore to be waterproofed. It was the perfect incentive for someone to produce a better and more economical element; thus I developed, as an alternative to the basic design, a 12-in. (305 mm) deep, 5-ft (1.5 m) wide and 33-ft 3-in. (10.1 m) long thin shell ribbed panel (Fig. 19 Item "d"). Such panels were built for some of these warehouses.

The May 3, 1953 issue of *The Texas Contractor*²⁷ describes the use of these panels at Kelly Air Force Base. They were also used at the AMC Warehouse at Mobile, Alabama AFB. With the 33½-ft (10.2 m) long panels, however, the span limits for precast reinforced concrete panels had been reached because of deflection problems.

The "Better Mousetrap"

It appeared that there was nowhere to go, while the demand to build longer-span structures was increasing. For the industry to survive, ways and means would have to be developed so that

products could be manufactured more efficiently and more economically, analogous to the principle of building a better "mousetrap." Around 1953, conditions were ideal for the appearance of pretensioned concrete elements.

These new products are exactly what Harry Edwards set out to develop. As illustrated in Fig. 27, it was sufficient to deepen the stem of the thin shell precast slab, to reduce its transverse span to 2 ft (610 mm) by cantilevering the slab, to prestress this new cross section and there it was! The prestressed double tee was the logical outgrowth of the thin shell precast panel.

With the need for new schools greater than ever, the incentive was there to try to extend the span of the double tee panels to 56 ft (17.1 m). Then, double tees could span two classrooms of 24 ft (7.3 m) each and an inside corridor of 8 ft (2.4 m).

This was accomplished economically by deepening the legs from 14 to 16 in. (356 to 406 mm). The precasters, working with steel form manufacturers, developed all-steel forms with leg fillers, making it possible to cast deeper (or shallower) double tee legs in the same standard forms. Some problems such as leakage of concrete ensued, but the industry overcame them one by one.

The absolute maximum spans for straight strands from panel end to panel end was now reached because of serious camber problems. The solution to this problem was one-point depressing of strands, followed by two-point depressing to solve yet another problem which arose, namely, ponding. Now the producers were again in business.

Cooperation with material suppliers, in this case the steel form manufacturers, allowed engineers to design and producers to manufacture a multitude of products with a variety of depths, such as channel slabs, key joists and even the unsymmetrical (and soon discarded) mono-wing tee, all in the same basic form.

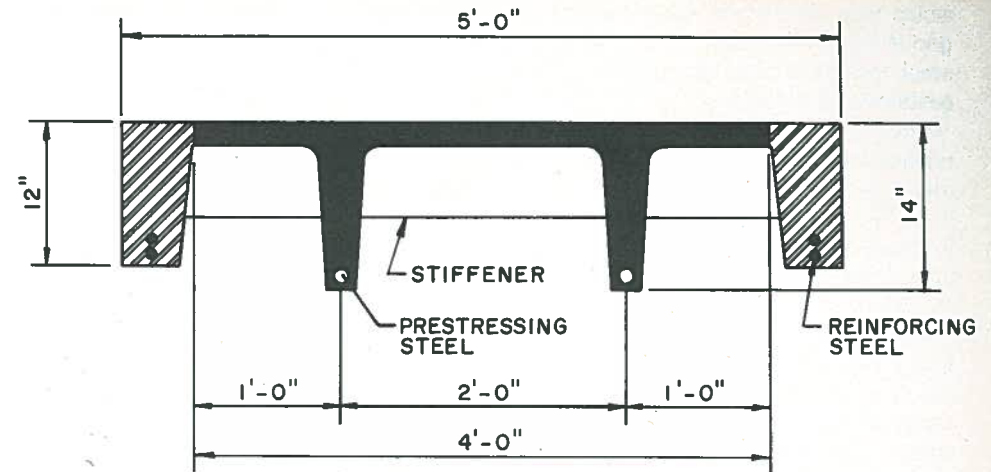

Fig. 27. From the 5-ft wide thin shell reinforced concrete roof panel with maximum span of 33 ft to the basic 4-ft wide 14-in. deep prestressed double-tee with maximum span of about 50 ft (with stem depth 16 in. in lieu of 14 in.) (See Fig. 19).

With pretensioning, it appeared the possibilities were limitless. After years of experience with the 4 and 5-ft (1.2 and 1.5 m) wide double tees, and the need and desire still there for larger spans such as required for typical three-span [60-40-60 ft (18.2-12.2-18.2 m)] parking garages, the single tee was developed by Professor T. Y. Lin (Item "f" in Fig. 19). It was to be followed by the 8-ft (2.4 m) wide double tee (Item "g" on Fig. 19). Thereafter, spans easily reached and even exceeded 100 ft (30.5 m).

The only span limitations were the restrictions imposed by transportation requirements, even though from time to time the technical literature has reported the transportation of precast units larger than 100 ft (30.5 m). Special transportation means have to be developed, and are generally modeled after fire engine trucks.

The Need for Larger Forces per Strand

In Part 2, it was stated that, due to inadequate bond capabilities particularly

under fatigue loadings, single smooth wire tendons would not be practical for structural concrete elements, unless the wires were of relatively small diameter. This meant that a large number of single wires were needed to provide even the comparatively small prestressing forces required. The resulting labor from handling so many wires, plus the problems of providing space between the wires for placing concrete, prevented assembly line production methods for large elements. It caused producers, such as Ben Baskin in particular, to look for better methods. A 3/16-in. (4.76 mm) diameter 7-wire strand yielding a working force of 3850 lbs (17.1 kN) per strand* was tried and found to be structurally more satisfactory than the individual standard bright 0.196 (5 mm) or 0.276 in. (7 mm) wires.

After it was discovered that the center wire would sometimes slip if all seven wires were the same diameter, the center wire was made larger than the outside wires so that the outside wires

* All forces are expressed in terms of 70 percent of guaranteed minimum breaking strength.

would bear against the center wire and grip it rather than bearing against each other to form a pipe through which the center wire could slip.

The $\frac{3}{16}$ -in. (4.76 mm) strand was soon replaced with the $\frac{1}{4}$ -in. (6.35 mm) diameter 7-wire strand yielding a working force of 6300 lbs (28.0 kN) per strand, followed by the $\frac{5}{16}$ -in. (7.94 mm) diameter strand with a working force of 10,150 lbs (45.1 kN) per strand.

It was widely believed that the structurally acceptable limit was reached with the $\frac{3}{8}$ -in. (9.53 mm) strand yielding a working force of 14,000 lbs (62.3 kN) per strand. Questions were raised concerning the bonding properties of this $\frac{3}{8}$ -in. (9.53 mm) strand, so extensive tests were run.[†] It was found that this strand had more than adequate bond under both static and fatigue loading.

For many years it was the standard size strand used as it met the plant requirements for assembly line production and was acceptable to Federal agencies for designs over which the Federal government had jurisdiction. It is on the basis of $\frac{3}{8}$ -in. (9.53 mm) strands that the first wave of standard sections for building and bridge elements were developed.

However, the consumer maintained pressure for even longer spans to carry still greater loads. Longer spans sustaining heavier loads required larger prestressing forces, which could only be provided by increasing the number of strands of the same diameter then manufactured, but the minimal economical concrete cross sections being used would not allow for the accommodation of such large numbers of wires.

The only way out was to use strands of larger diameter which would each yield larger unit prestressing forces. At the same time, the use of fewer strands would reduce costs and preserve com-

petitiveness. For example, the placing and tensioning of strands in a prestressing bed is a sizable percentage of the labor costs.

The wire manufacturers met the challenge and came through with flying colors. They produced the $\frac{7}{16}$ -in. (11.1 mm) diameter strand yielding a force of 18,900 lbs (84.1 kN) and eventually the $\frac{1}{2}$ -in. (12.7 mm) strand with 25,200 lbs (112 kN) force per strand!

All the above mentioned strands had an ultimate strength of 250,000 psi (1724 MPa). When this strength was increased to 270,000 psi (1862 MPa) the above forces increased correspondingly by about 8.5 percent. Thus, increasing the diameter from $\frac{7}{16}$ in. (4.8 mm) to $\frac{1}{2}$ in. (12.7 mm), physically a relatively small increase, allowed increased prestressing forces from 3850 lbs (17.1 kN) per strand to 25,200 lbs (112 kN)! By contrast, the prestressing force possible with a 0.192 in. (4.9 mm) single wire is about 5080 lbs (22.6 kN), and with a 0.276 in. (7.0 mm) single wire, 9880 lbs (43.9 kN)!

But change does not come easily: as mentioned before, for many years the $\frac{3}{8}$ in. (9.5 mm) diameter strand at 250 ksi (1724 MPa) ultimate strength remained the standard one in use. Wires larger than $\frac{3}{8}$ in. (9.5 mm) diameter were not permitted on federally financed projects and funds were withheld on those using strands of larger diameter, until the larger strands had been extensively tested like the $\frac{3}{8}$ -in. (9.5 mm) strand. Of course, eventually the larger strand sizes were accepted. As the saying goes, "The difficult we do now, the impossible will take a little longer."

Standardization—Key to Efficient Production

Although strands were the key to permitting economical assembly line production of prestressed concrete elements, it soon became apparent that

only fully efficient²⁸ production would yield competitive products. Efficiency meant both maximum use of the plant facilities, or daily casting cycles, and repetitive use of the sturdy but very expensive forms for standard products. Unfortunately, in the beginning there were no standard products.

In contrast to the Perlmutter who basically were builders, Harry Edwards was a consulting engineer who worked closely with builders and who understood clearly their problems. He immediately undertook the task of designing standard building products such as channel slabs, double tees, and key joists in conjunction with the design and preparation of engineering drawings for constructing pretensioning facilities.

These "standards," continuously improved and enlarged as production techniques got better and expanded, became known as the LEAP products. The increasing excitement with prestressed concrete became so great that their use spread like wildfire; it did not take long for a network of "LEAP" plants to come into existence, predominantly east of the Mississippi.

In consultation with form manufacturers and producers, shapes of products were designed so that products having a variety of widths and depths could be cast in the same forms. The designs culminated in the development, and immediate acceptance, of the loading tables which became so prevalent and so familiar throughout the industry.

And wouldn't you know it? Each consulting engineer who thought himself an "expert" on prestressed concrete, myself included, followed Harry Edwards' lead, developing designs for his own "original" cross sections and claiming, as is so human, that his sections were the most efficient to cast, the strongest and the most economical. The poor producer became confused, not knowing whom to believe, as in general his strength was production and not engineering.

But this too passed. After many years of "stresses and strains," our Institute presented to the producers the standards it had developed for building components, and at last brought order where disarray and chaos had reigned.

Need for Standardization of Bridge Girders

Simplifications for improving productivity did not come easily as the case of bridge beams and girders will make clear. In the early days, each engineer would design bridge girder sections believing that his were the most efficient and economical for a given span and load. For example, the cross sections of the girders for the Garden State Parkway, designed by Gannett, Fleming, Corddry and Carpenter, Inc., were different from those of the Egg Harbor Bridge located in the same vicinity but designed by Joseph K. Knoerle and Associates.

However, the girders for both projects were produced by the same producer, the Formigli Corporation of Berlin, New Jersey, which had to purchase two different sets of costly forms. Before long, producers were literally drowning in costly steel forms which had to be depreciated on a single project, driving the unit price sky high. It made no sense.

There was no use talking to engineers; they are a ferociously independent breed. Fortunately for the industry, Eric Erickson came to the rescue of the producers.

Erickson the Man and Engineer

Eric L. Erickson, a native of Louisiana, was chief of the Bridge Branch of the Bureau of Public Roads, Washington, D.C., now known as the Federal Highway Administration.

[†] See for example the work done by Professor Walter Blessey at this time (January-February 1980 PCI JOURNAL, pp. 133-136).



Eric L. Erickson

Erickson was a most capable, conservative and realistic civil engineer. Conservative, because he realized that, as a civil service engineer whose responsibility was to approve bridge plans for construction, his foremost responsibility was to insure the safety of the public. He could be as stubborn as Dutchmen are reputed to be, but one could not help liking the man and admiring his ability, sincerity and honesty.

Erickson spent much time on the road, close to the action, as he wanted to have firsthand knowledge of bridge construction field conditions. He became increasingly interested in prestressed concrete and began to visualize its potential.

In the early fifties prestressed concrete was still relatively new in America. There were only a few enterprises in the private sector promoting its use, and only limited progress had been made in its application to bridges. Since the Federal government had not as yet developed the 90-10 program for the construction of highways, each state had to be approached separately and told

* The Prestressed Concrete Institute recognized Erickson's efforts to further the use of prestressed concrete, bestowing upon him an honorary membership for his invaluable contribution to the art of prestressing.

about prestressed concrete, a herculean undertaking. Obviously, the structural steel industry was not going to help.

However, in 1950, with the supply of steel down and prices up, the question was, how to build bridges without steel? The obvious answer was to make more use of prestressed concrete since it had been used so successfully in Europe.

True to government tradition, the first item on the agenda for making prestressed concrete acceptable to the federal government was to set up rules for design, specifications for materials, and procedures for construction. The result was the publication, in March 1952, of mimeographed sheets of the *Design Criteria for Prestressed Concrete Bridges*, to serve as the basis for design.

This document and the 1954 revised and expanded version (Fig. 28),²⁹ were to have a tremendous impact on the development of prestressed concrete construction. Unlike many other Government-sponsored documents, both the 1952 and 1954 versions of the Criteria were masterpieces in concept and actual content, served as the basis for research, design and construction of bridges in prestressed concrete for many years.*

The second item on the agenda was equally important, as it was to give direction to the producers. Concurrent with the development of the 1952 Criteria, Erickson and his staff began preparing a set of standard girder drawings for post-tensioned deck girder bridges. Fully detailed drawings for three different girder cross sections, for 25, 30, and 35-ft (7.6, 9.1, and 10.7 m) spans, were shown on the drawings. The entire set of Standards was made available to the general public by the Bureau of Public Roads, U.S. Department of Commerce, on March 10, 1952.

A revised, substantially expanded and most elaborate set of Standard Drawings for pretensioned and post-tensioned I-beam bridge decks, and pre-

stressed adjacent box girders, based on the 1954 revised Criteria, was ready to be issued in September 1956. A brief description of these can be found boxed on p. 109.

A preview of this set disclosed a masterful job of design and particularly of detailing, with dimensions down to 1/8 of an inch (3.18 mm)! But the practical result of this masterpiece was devastating because of the complexity of the whole: the number of different cross sections for 24-ft (7.3 m) wide roadways

Fig. 28. Cover of the 1954 revised and expanded edition of the "Criteria for Prestressed Concrete Bridges." More than 50,000 copies were sold by 1958. It is a magnificent document, one of which any government agency would be justifiably proud.

Criteria for Prestressed Concrete Bridges



U. S. DEPARTMENT OF COMMERCE
BUREAU OF PUBLIC ROADS
WASHINGTON, 1954

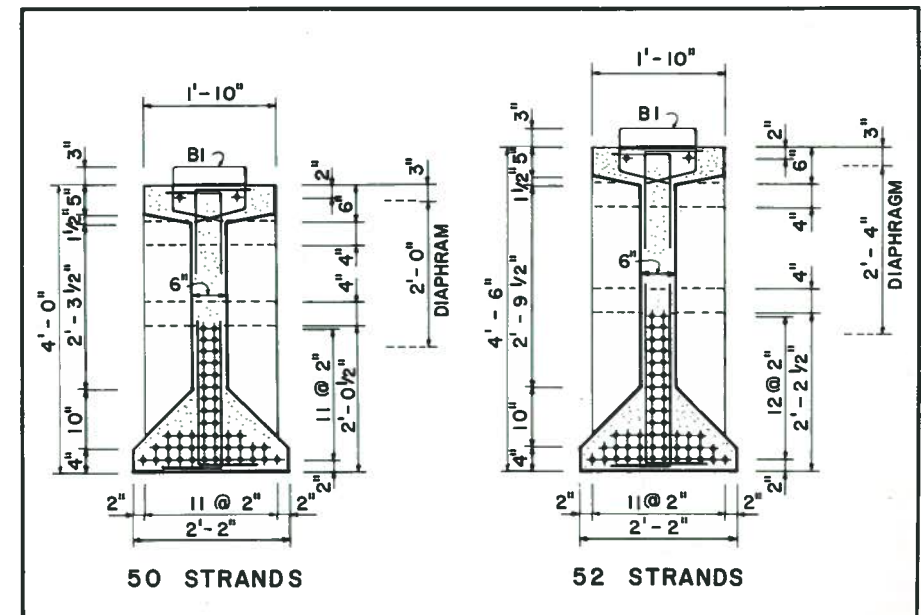

Fig. 29. At left, the BPR's proposed 70-ft span pretensioned standard girder for 24-ft roadway and H15-44 loading. At right, the proposed 70-ft span pretensioned standard girder for 28-ft roadway and H20-S16-44 loading. Their unwarranted difficulty in manufacture should be evident.

for H15-44 loadings and for 28-ft (8.5 m) wide roadways for H20-S16 loadings would make a precaster's head swim.

To make matters worse, the cross sections were patterned after European practice, which consists of using minimum size cross sections for a given span (such as thin flanges, thin webs for deep girders, and shallow slopes for underflanges, as shown on Fig. 29). American producers had already learned that such sections did not lend themselves well to American construction practice.

In order for a State to be considered for 90-10 Federal participation, it had to comply with federal requirements and design standards. To compel American producers to cast girders in accordance with the proposed standards would have been a calamity.

On behalf of the industry, PCI's first president, Douglas P. Cone (1954-1955), second president George Ford (1955-1956) and others, including myself, met with Erickson before these Standards were officially made available to the public. We explained to him and his staff the anticipated casting difficulties that would result from the use of the Bureau's proposed standards—which would defeat the purpose of economy the Bureau had hoped to achieve. Erickson reluctantly agreed with the consensus opinion.

He decided that, upon acceptance by AASHO's Bridge Sub-Committee of the bridge cross sections which Bill Dean as Chairman of the Joint AASHO-PCI Committee was in the process of developing, he would withdraw the standards which had taken him years of hard and costly work. In the meantime, the Bureau would approve prestressed concrete designs submitted to it which had been based on the Bureau's Standards.

About six months after our meeting, in the spring of 1957, the AASHO Bridge Committee voted acceptance of AASHO-PCI's Joint Committee Standards.³⁰ True to his word, Erickson with-

drew his Standards which, although they had served their purpose in the interim, were now obsolete.

The meeting with Erickson was very rewarding, one which I remember with great pleasure. It must be pointed out that it takes a big man of great character and courage to admit and accept that years of tedious work should be scrapped. Eric Erickson, facing challenge and controversy, could recognize and admit that an error in judgment had been made, and accept the responsibilities.

But we did not always succeed with Erickson at a first confrontation! Take, for example, the cases of end blocks, strand sizes, and shear keys for composite construction. These matters were at the time vital to the industry and had to be resolved. Perseverance, hard and diligent work and mental anguish by producers and engineers alike as explained further brought eventually the desired structurally adequate solution.

End Blocks and Pretensioned Work

End blocks in pretensioned I-girders were a carryover from post-tensioned girders where they are a necessity. They were the curse of the producer: for each change in length of girders having the same cross section, the side forms had to be reset to accommodate the end blocks. This was a costly, time consuming and a frustrating operation, as it delayed the casting cycle.

Indeed, engineers were hard put to find a rationale for end blocks in pretensioned work. In pretensioning, where the forces are transmitted to the concrete by bond and not as concentrated end forces, the need for end blocks can logically be questioned.³¹ Furthermore, the AASHO-PCI I-beam standards are stubby, "fat and sassy," not slender as their European counterparts are. One could consider an AASHO-PCI cross section as being an end block for the entire length of the beam and therefore

EXCERPTS FROM DESIGN CRITERIA FOR PRESTRESSED CONCRETE BRIDGES (1956)

Because of the enormous work involved in the preparation of the 1956 Bridge Standards by Erickson's staff we must, to be fair, describe briefly these Standards (Note: 1 in. = 25.4 mm, 1 ft = 0.305 m).

* * *

Adjacent Box Girders

Spans from 25 to 45 ft: A set of detailed drawings was developed for pretensioned adjacent box girders for a 28 ft wide roadway, H20-S16-44 loadings. Spans were from 25 to 45 ft. The width of a box girder was 4 ft. The depths were 1 ft 2 in., 1 ft 4 in., 1 ft 7 in., 1 ft 9 in. and 2 ft for the various spans.

Spans from 40 to 70 ft: A set of detailed drawings was developed for pretensioned adjacent box girders for a 28 ft wide roadway, H20-S16-44 loadings. Spans were from 40 to 70 ft. The widths of a box girder for this set of girders were 3 ft in lieu of 4 ft for the previous set of spans. Depths were 2, 2½, 3 and 3½ ft for the various spans.

Pre-Tensioned I-Girders

A set of detailed drawings was developed

for pretensioned I girders for 24-ft wide roadways for H-15-44 loadings and another set for 28-ft wide roadways for H20-S16-44 loadings. Each set was fully detailed for 35, 40, 45, 50, 60, and 70 ft. Cross sections varied for each span.

Post-Tensioned I-Girders

A set of detailed drawings was developed for post-tensioned I girders for 24-ft wide roadways for H-15-44 loadings and another set for 28-ft wide roadways for H20-S16-44 loadings. Each set was fully detailed for spans from 50 to 100 ft in increments of 10 ft.

General Details

Two sheets were developed with details applicable to all spans from 35 to 100 ft for both pretensioned and post-tensioned girders.

end blocks would have been superfluous. However, Erickson insisted on having end blocks even though there was precedent for their elimination: for instance, the Garden State Parkway and Egg Harbor girders (see Fig. 30), mentioned earlier, did not have end blocks. Nor did the girders for 224 bridges of the Northern Illinois Toll Highway (Fig. 31),³² in spite of Erickson's objections and without his approval, simply because the

Toll Highway was privately financed.

Maury Bender, chief engineer of Joseph K. Noerle and Associates, was responsible for the design and construction of both the Egg Harbor and Illinois Toll Highway bridges. Many a verbal battle (on a high professional level) ensued between him and Erickson for a long time, while AASHO specifications for pretensioned bridge beams continued to require provision of end blocks.

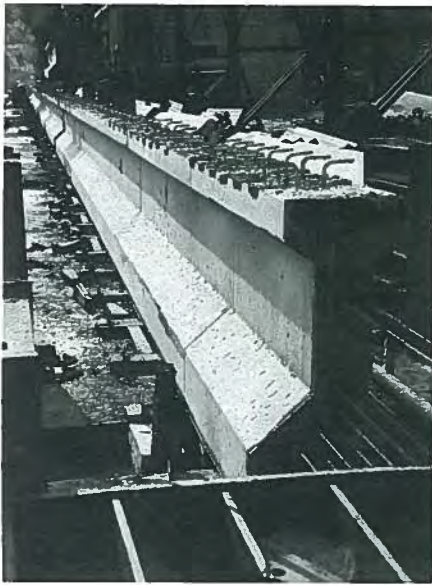

Fig. 30. 1953 pretensioned girder for Garden State Parkway, New Jersey cast without end blocks, contrary to Bureau of Public Roads' requirements.

The requirement for end blocks remained until tests at the University of Florida, sponsored by the Florida State Road Department under the direction of Bill Dean, in association with Dr. Alan M. Ozell, proved beyond any shadow of doubt that end blocks in pretensioned bridge beams were superfluous.³³ After the successful completion of these tests, the Bureau of Public Roads no longer questioned the need for end blocks for the AASHTO-PCI standard bridge beams; and at its May, 1961 meeting, the AASHTO Bridge Committee modified its recommendation as to end blocks, to read: "For beams with post-tensioned tendons, end blocks shall be used to distribute the concentrated prestressing forces at the anchorage. Where all tendons are pretensioned wires or 7-wire strands the use of end blocks will not be required."

All that Erickson really wanted was physical evidence that end blocks were

unnecessary in pretensioned work, but in the meantime, it was a real burden on the industry.

The "Fight" for Larger Strands

For reasons of economy, it was important to use larger sized strands, producing larger prestressing forces with fewer strands. However, for many years the size of 7-wire strand for pretensioning was limited by the Bureau of Public Roads Criteria to $\frac{7}{16}$ in. (9.5 mm).

Here again Erickson wanted "scientific" physical evidence that $\frac{7}{16}$ -in. (11.1 mm) strands met the required bond characteristics. This strand was questioned on Federal Aid jobs, in spite of the fact that Bill Dean in his own state practice was regularly using $\frac{7}{16}$ -in. (11.1 mm) strand stressed to 18,900 lbs (84.1 kN).

Maury Bender also used $\frac{7}{16}$ -in. (11.1 mm) strands for the 448,000 linear ft (136,600 m) of beams required on the Northern Illinois Toll Highway. As a Toll Road, it was financed by the private sector and therefore not subject to federal requirements. Maury Bender used his own engineering judgment and was not afraid to take responsibility for his decision.

As in the case of end blocks, Bill Dean resolved the impasse by initiating tests at the University of Florida on 6 in. x 6 ft (152 mm x 152 mm x 1.83 m) specimens as well as on 2-ft 3-in. (686 mm) deep 41 ft (12.5 m) long beams under static loads. In the former, a single $\frac{7}{16}$ -in. (11.1 mm) strand was embedded, in the latter nineteen $\frac{7}{16}$ in. strands. Each was stressed with a force of 18,900 lbs (84.1 kN). Subsequently, the tests were expanded to include 6 in. x 8 in. x 20 ft (152 mm x 203 mm x 6.1 m) beams with two $\frac{7}{16}$ -in. (11.1 mm) strands. This series of tests convinced Bill Dean of the safety of his practice of using $\frac{7}{16}$ -in. (11.1 mm) strands with stress release when concrete had reached 4000 psi (17.8 MPa) strength.

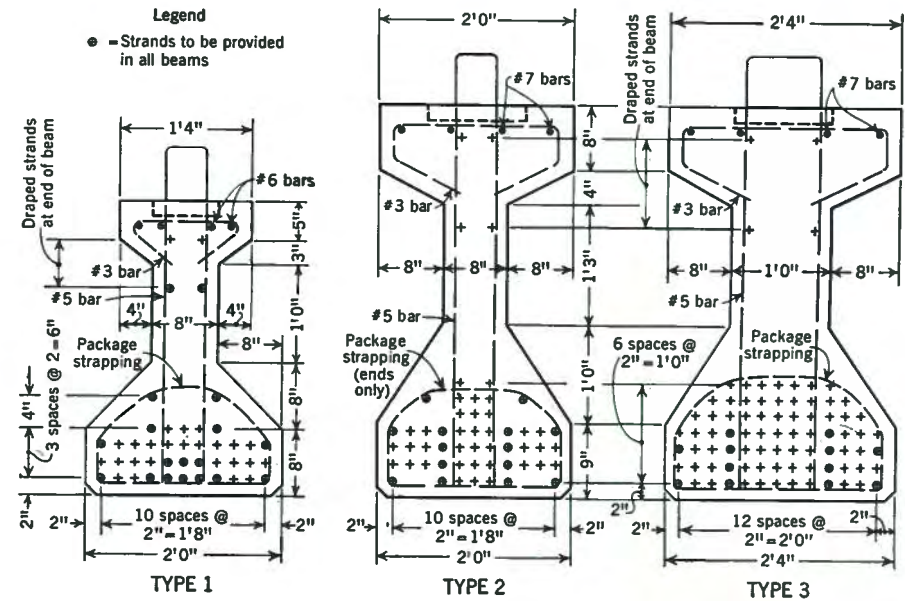

Fig. 31a. Typical beam sections are shown near center for Types 1, 2 and 3. Note that Type 3 is identical with Type 2, except that it is 4 in. wider throughout. Side forms can be the same; only bottom pallets differ. Also note that Types 1 and 2 can be cast on the same line.

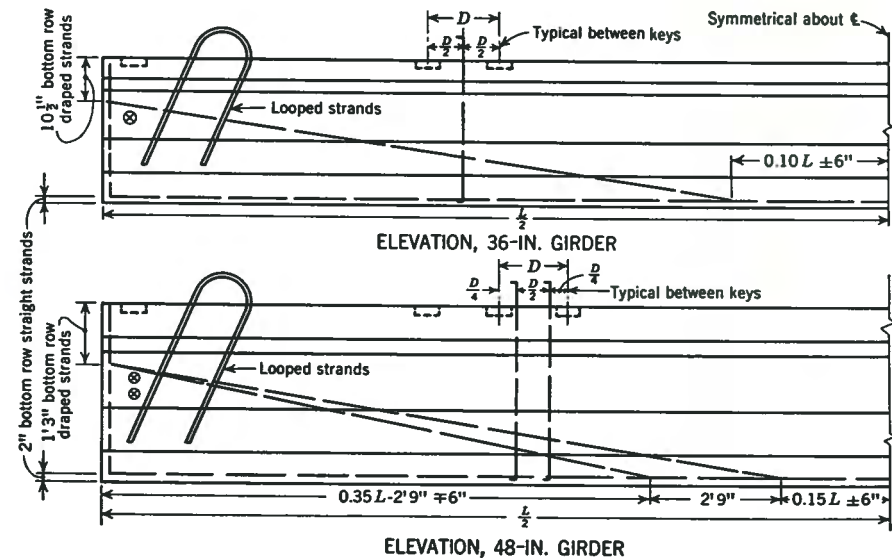

Fig. 31b. The $\frac{7}{16}$ -in. strands are tied down and pretensioned in the beams, which vary in length from 40 to 90 ft and do not have end blocks.

Following these tests the use of 7/16-in. (11.1 mm) strands by Bill Dean in his work was no longer questioned by any approving agency.

The Bug-a-Boo* of Composite Construction

In the early designs of precast prestressed girders and cast-in-place concrete decks, mechanical bonding devices consisted of stirrups extending beyond the top surface of the girder into the slab and of raised or depressed keys on top of the girder. Producers found these keys to be, at best, construction nuisances: raised keys were apt to interfere with the placing of slab steel and depressed keys were perfect trash catchers.

Based on his understanding of engineering design, Bill Dean had a strong suspicion that keys were superfluous. He expressed his feelings and contempt for those who thought otherwise in his usual expressive and colorful way: "It seems to me that you need keys as much as a bull has use for—teats." Thus Dean decided to check his suspicions and set out to prove his point.

Bill Dean tested to destruction, statically, three full-sized composite bridge sections consisting each of a 48-ft (14.6 m) prestressed concrete beam with a 6-ft (1.8 m) side slab cast on top.³³ The elements were bonded by shear keys and stirrups. In each case, failure occurred in the center third of the beam, from a combination of flexural and diagonal stress. In no case did failure of bond between the two elements contribute to failure of the specimens; in fact there was no evidence of the slightest distress along the plane of joining.

A fourth such test was made without shear keys but with the top of the beam moderately rough. The results were the same. In the fifth test, the top of the beam was given a smooth trowelled fin-

ish; the results remained as before.³⁴ Bill Dean concluded: "If sufficient steel is provided to develop the vertical component of joint stress, the horizontal component could be taken by bond of the concrete, provided the bond stresses were within the limits ordinarily used for bond of reinforcing bars.

This reasoning would eliminate shear keys in most instances but was questioned by our reviewing agency because all of our tests had been static and results under repetitive loading were desired."

And so, in 1957, a project was initiated at the University of Florida to study several aspects of composite construction consisting of precast prestressed girders with a cast-in-place top under repetitive loading.³⁵ A principal objective was observation of the joint between the two elements for which no shear keys were to be provided.

Among the conclusions at the completion of the elaborate tests were:

1. None of the composite beams showed any failure along the plane of contact.
2. The natural bond between the two concretes and the presence of four shear ties at each end of the beam provided a composite action strong enough to withstand repetitive overloads.

Following these tests, Florida practice in composite beams was to provide extended stirrups to develop the vertical component of shear between elements.³⁶ Tops of beams were left moderately roughened and shear keys were generally eliminated. Before long this practice was followed throughout the United States—with no comeback from the Bureau of Public Roads.

* * *

In the final analysis, we must acknowledge that Eric Erickson, as a powerful engineer in command, did, after all, understand the needs of the producer;

that, as a practical engineer, he did reject his own unworkable standards; and that he did sponsor and encourage in a unique way the publication of the remarkable Criteria of which more than 50,000 copies were sold (at 15 cents a copy!). He was a big enough man to reverse his decisions on end blocks, wire sizes and concrete keys, even though he had to be nudged—not always too gently—for a long time.

The industry should remember him with pride. It was fortunate to have had, at the right time and in the right place, a man of his caliber and stature. It is truly said that, while one machine in this increasingly mechanical age can do the work of 50 men, no machine can do the work of one extraordinary man.

Those who knew Erickson will remember him and have a soft spot in their hearts because he fought for what he thought was right, for sound and safe engineering practices. Above all, he was understanding and human, accessible and fair. To me, he was the Civil Servant par excellence.

PCA Contributions

For many years prior to the organization of PCI, the Portland Cement Association's technical and promotional contributions as well as its outstanding and sophisticated research work at their laboratories in Skokie, Illinois, were unmatched by any other single institutional or commercial entity. But above all, their engineers' availability, anywhere, at any time, gave many consulting engineers and contractors the courage and confidence necessary to pursue their endeavors in the prestressed concrete field.

A national organization, the Portland Cement Association (PCA) had as its purpose "dedication to scientific research, development of new or improved products and methods, to offer technical service, promotion and educational effort

(including safety work)." The activities were primarily designed to improve and extend the uses of portland cement and concrete. To this end, Arthur Boase, a stern, severe but most competent engineer, had organized, in the late thirties, a very capable Structural Bureau at PCA's headquarters in Chicago, Illinois. He directed the Bureau and a network of regional Structural Bureaus with offices located in all of the major cities of the United States and Canada.* Upon his death in the early forties, he was succeeded by Leo Corning, who continued Boase's policies and work, with the help of Alfred Parme and Thor Germundsson.

Alfred Parme was basically the "inside man," concerned with developing design charts, tables, graphs, nomographs, diagrams and other such handy aids, which considerably simplified and reduced the designer's work.†

Thor Germundsson did much of the same work but, in addition, was the public relations man, in contact both with the various PCA offices throughout the United States and with outsiders to PCA. He was a diplomat, though in my opinion he was not always the smooth negotiator he should have been: witness the long discussions at the time when the writing of codes and specifications was of the greatest urgency. But he was a delightful individual, and a capable engineer respected throughout the profession. He was, in contrast, to Parme, the "outside man."

Upon Al Cummings' death, Thor Germundsson became Chairman of the ACI-ASCE Joint Committee 323. In 1956, Burr Bennett, later executive director of PCI, joined the committee as secretary, to coordinate and analyze the

* In recognition of his work, the American Concrete Institute has created the yearly Arthur Boase Award.

† Retired from PCA, Al Parme, still a wizard with numbers, is presently living in La Jolla, California, where he practices as a special consultant. He was retained by PCI in connection with the preparation of PCI's *Design Handbook*.

sub-committees at work developing the "Tentative Recommendations for Prestressed Concrete."

In accordance with PCA's goal as stated above, the word went out from Corning's office to PCA's district and regional offices after Magnel's talks in the United States and the impending construction of the Walnut Lane Bridge, to look out for matters related to prestressed concrete work. This eventually resulted in PCA taking an active part in the promotion of the new material. Leo Corning realized that prestressed concrete was a product which could very well bring an increase in concrete construction and, in turn, increase sales of cement.

PCA's promotion covered mainly two distinct areas: development of technical data and engineering aids in the home office and their subsequent dissemination through the network of regional and district offices. The development in the home office of technical information and data for use by designers was assigned, logically, to Al Parme and Thor Germondsson. The results of their work can be found in numerous structural bulletins and other publications.

The first such Bulletin, entitled "Design of Prestressed Concrete," was issued in 1950 and a second, "Prestressed Concrete Bridge Calculations Illustrate Use of Design Criteria," was published in 1952. Leo Corning's office made these remarkable documents, printed in large quantities, available at no cost to anyone making the request. In 1951, PCA issued the "Notes on Design Specifications for Prestressed Concrete." It was, in 1951, the first American publication discussing specifications.

These publications made a profound impression on the engineering profession and further popularized the use of prestressed concrete.

In addition to publishing purely technical data, PCA also made available, on a more or less regular basis, elaborate, effective and appealing non-technical

bulletins with data on and illustrations of completed prestressed concrete structures. These particular bulletins, published largely in trade magazines, were patterned after *Life* magazine.

The second area of activity, the dissemination of knowledge, was the responsibility of engineers working in PCA's regional and district offices. To keep the engineering fraternity abreast with nationwide developments all the district and regional structural engineers were brought from time to time to Chicago for indoctrination through lectures and discussions by men in the industry. It was my privilege to address this distinguished group at the time of the Walnut Lane Bridge construction. The subsequent discussions clarified many aspects of design and construction.

Consequently, the many local PCA offices had the wherewithal to become active in spreading information. The PCA local structural engineers were available to consulting engineers, contractors and other interested parties for advice and guidance in prestressed concrete matters: and organized short courses and seminars, which they did with flair.

In Philadelphia, for example, district engineer Robert M. Reindollar, Jr. was responsible for sponsoring, jointly with Drexel Institute (now Drexel University), a series of lectures twice weekly for a month in 1952. More than 400 engineers attended, filling Drexel's auditorium to capacity. For program see Fig. 32.

The lectures were such a huge success that it prompted Reindollar to organize similar lecture series in Harrisburg, Pennsylvania and Baltimore, Maryland. The latter was sponsored jointly with the Engineering School at John Hopkins University. As a sequel to the 1952 series of lectures, PCA and Drexel Institute sponsored a lecture by Professor Magnel on February 3, 1953.

All these lectures, and the voluminous material freely distributed, were extremely well received.

THE DREXEL INSTITUTE OF TECHNOLOGY AND THE PORTLAND CEMENT ASSOCIATION PRESENT A SERIES OF LECTURES ON PRESTRESSED CONCRETE

MONDAYS AND WEDNESDAYS

Jan. 14, 16, 21, 23, 28, 30

Feb. 4 and 6, 1952

7:30 P.M. until 9:30 P.M.

LECTURE SCHEDULE

Monday, January 14.

Opening Remarks.

Dr. James Creese, President,
Drexel Institute of Technology.
R. M. Reindollar, Jr., District Engineer,
Portland Cement Association.

Fundamentals and Demonstration.

Charles A. Keelen, Structural Engineer,
Portland Cement Association, Pittsburgh, Pa.

Wednesday, January 16.

Development and Research.

C. C. Singleton, Regional Structural Engineer,
Portland Cement Association, Philadelphia, Pa.

*Application of Prestressed Concrete to Dams,
Foundations, Underpinning, Etc. (Structures
other than Beams & Girders).*

N. Thorsen, Engineer,
Freyssinet Company, Inc., New York City.

Monday, January 21.

Analysis and Design of Structural Members.

1. *How to Select the Section for Given Span & Loading.*
2. *How to Analyze a Given Section.*

Charles C. Zollman, Chief Engineer,
Vacuum Concrete Corp., Philadelphia, Pa.
(Associated on the design of the Walnut Lane Bridge,
Philadelphia; the Tampa Bay Bridge, Florida; and the
Tulsa, Oklahoma School Buildings.)

Wednesday, January 23.

*Requirements and Production of Concrete for
Prestressed Members.*

Harry F. Irwin, Consulting Engineer,
Philadelphia, Pa.

THE DREXEL AUDITORIUM

32nd & Chestnut Sts.

Philadelphia, Pa.

There Are No Fees.

Characteristics of Prestressing Steel.

W. O. Everling, Director of Research,
American Steel & Wire Co., Cleveland, Ohio.

*Simplified Methods for Designing Prestressed
Concrete.*

K. P. Billner, President,
Vacuum Concrete Corporation, Philadelphia, Pa.

Precast Prestressed Bridge Slabs in Pennsylvania.

B. J. Baskin, Chief Engineer,
Concrete Products Company of America, Philadelphia, Pa.

Monday, January 28.

*Materials for Tensioning Elements in Prestressed
Concrete and Developments in Modern Tech-
niques.*

J. N. Hicks, Business Manager, Bridge Division,
John A. Roebing's Sons Company, Trenton, N. J.

Wednesday, January 30.

*General Design Considerations and Criteria.
Review of European and American Prestress
Techniques.*

M. Fornerod, Chief Engineer,
Preload Enterprises, Inc., New York City.

Some Inspection and Construction Essentials.

Samuel S. Baxter, Acting Chief Engineer,
Bureau of Engineering and Surveys, Department of
Public Works,
City of Philadelphia, Philadelphia, Pa.

Monday, February 4.

*Research and Development in American Building
Practice.*

A. T. Waidelich, Vice President and Manager, Research
Division,
The Austin Company, Cleveland, Ohio.
R. F. Wittenmyer, Engineer, Research Division,
The Austin Company, Cleveland, Ohio.

Wednesday, February 6.

*Open Forum (Procedure to be announced on
January 14)*

Fig. 32. Program for popular Drexel Institute lecture series (Jan.-Feb. 1952).

PCA's activities were not limited to the East. In Oklahoma City, Wenzel was covering the mid-Atlantic States. He was later transferred to Atlanta when Luke Cheney, of PCA's Atlanta Office was assigned to Washington, D.C. Luke was put in charge of this prestigious office and became active in PCA's national affairs. In Minneapolis-St. Paul, PCA engineers were concerned at that time with the proposed prestressed concrete Garrison Dam bridge in North Dakota.

Returning to the East, John Hogan was at that time the PCA structural engineer in New York City. A strapping, tall and husky man, as Irish as they came, John knew his way around the labyrinth of New York City officialdom. He was a friend of many concrete contractors, among which was the foremost American precast (as well as cast-in-place) concrete builder, the late Roger Corbetta, founder and President of Corbetta Construction Company. And he was equally well at home with many New York consulting engineers who respected him for his knowledge, courtesy and willingness to help, particularly on matters pertaining to prestressed concrete work.

The mention of "Corbetta" brings to mind a memorable interchange I witnessed around 1955 and which left quite an imprint on my mind about the vagaries and destiny in life and drove forcefully home the economic penalties and loss in competitiveness which result when forms cannot be reused a sufficient number of times.

In the foyer of the Statler Hotel in New York City where the American Concrete Institute was holding its annual convention, Corbetta was discussing with the late John Kyle, chief engineer of the New York Port Authority, and others, the bid results of the previous day for the construction of two large aircraft maintenance hangars at the then Idlewild (now JFK) Airport in Queens, New York. Con-

tract documents had been prepared by a consultant for the New York Port Authority for both a prestressed concrete design and a structural steel design; structural steel was low.

Corbetta was voicing to Kyle his bitterness and disappointment on having lost the job—he had wanted it badly and no doubt his pride was also hurt. Imagine Corbetta's fury when Kyle announced that he was going to extend the contract by negotiating with the low bidder for a third hangar! Corbetta was livid. "Had I known that," he said, "I could have lowered my bid, because I could have had three re-uses of my forms rather than only two. This would have made all the difference. I would have been low on the prestressed concrete design."

Indeed, how fate can change the course of events! If the prestressed concrete design would have been built, it would have set the stage for more of such hangars. However, it was not meant to be—but that's the way the ball bounces!

PCA was extremely active in research and development work in their Skokie laboratories, searching for answers to some of the problems nagging the concrete industry in general and the prestressed concrete industry in particular. Among these problems were: the significance of horizontal hair cracking in the ends of pretensioned girders,³¹ means of achieving continuity in a structure with pretensioned beams, evaluation of the merits of lightweight aggregates for prestressed concrete work, and the impact of fire on the behavior of prestressed concrete elements.

Quite a number of PCA publications describe their valuable work, much of it on full sized members. Some of the work related to fire ratings, a matter of vital importance to the prestressing industry, will be briefly reviewed in the next issue of the JOURNAL.

* * *

REFERENCES

19. Hall, D. G., "Precast Concrete Permits Rapid Construction of Large Marine Training Center," *Civil Engineering*, August 1953.
20. Bobish, William J., "Eleventh Naval District Builds with Precast Concrete," R/C Publication, Portland Cement Association, 1953.
21. Prock, Benton H., "Precasting Techniques Reduce Cost of Naval Ordnance Depot," R/C Publication, Portland Cement Association, 1953.
22. Zollman, Charles C., "Four Million Square Feet of Thin-Shell Rib Panels for Roof Framing," *ACI Journal*, Proceedings V. 49, May 1953, pp. 809-823.
23. Amerkian, Arsham, "Thin-Shell Precast Concrete—An Economical Framing System," *ACI Journal*, Proceedings V. 49, May 1953, pp. 775-794.
24. Wailes, C. D., Jr., "Factory Production and Field Installation of Thin Ribbed Precast Panels," *ACI Journal*, Proceedings V. 49, May 1953, pp. 797-808.
25. Twaits, Ford J., and Denn, Martin M., "Fabrication and Erection of Precast Enclosure Framing for One-Story Barracks," *ACI Journal*, Proceedings V. 49, May 1953, pp. 825-832.
26. Prock, Benton H., "Careful Planning a Necessity in Building with Precast Concrete," *ACI Journal*, Proceedings V. 49, May 1953, pp. 833-840.
27. White, W. H., "Thin-Shell Precast Concrete Roof Panels Utilized in Kelly AFB Warehouse Projects," *The Texas Contractor*, May 3, 1953.
28. Zollman, Charles C., "Planning and Design of Installations for Today's Pretensioned Requirements," *PCI JOURNAL*, V. 2, No. 4, March 1958, pp. 72-74.
29. *Criteria for Prestressed Concrete Bridges*, U.S. Department of Commerce, Bureau of Public Roads, Washington, 1954, 25 pp. (Superintendent of Documents, U.S. Government Printing Office, Washington 25, D.C. Price: 15 cents!)
30. Paxson, Glenn S., "Standardization of Prestressed Concrete Highway Bridge Members," *PCI JOURNAL*, V. 7, No. 1, February 1962, pp. 13-19.
31. Marshall, W. T., and Mattock, Alan H., "Control of Horizontal Cracking in the Ends of Pretensioned Concrete Girders," *PCI JOURNAL*, V. 7, No. 5, October 1962, pp. 56-74.
32. Zollman, Charles C., "Bold Planning Results in Efficient Production of Prestressed Girders," *Civil Engineering*, June 1958.
33. Dean, W. E., "Research in Prestressed Concrete at the University of Florida and its Practical Application in Bridge Practice," *PCI JOURNAL*, V. 6, No. 4, December 1961, pp. 60-70.
34. Dean, W. E., and Ozell, A. M., "No Shear Keys are Needed Here," *Engineering News Record*, June 7, 1956. (Results published here are part of "Static Testing of a Composite Section Constructed Without Shear Keys" by the same authors.)
35. Ozell, A. M., and Diniz, J. F., "Composite Prestressed Concrete Beams Under Repetitive Loading," *PCI JOURNAL*, V. 2, No. 4, March 1958, pp. 19-27.
36. Dean, W. E., "Research in Prestressed Concrete at The University of Florida and its Practical Application in Bridge Practice," *PCI JOURNAL*, V. 6, No. 4, December, 1961, pp. 60-70. (Summarizes then-current research at the University and includes a list of research reports and technical papers by University of Florida researchers.)

* * *

NOTE: Article continues in Part 9 (cont.), p. 332.

Part 9 (cont.)

The End of the "Beginnings"



Charles C. Zollman
Consulting Engineer
Newtown Square, Pennsylvania

"Electronic calculators can solve problems which the man who made them cannot solve; but no government-subsidized commission of engineers and physicists could create a worm."
Joseph Wood Kruten, American critic, essayist, teacher

In the last two issues I described some early work with cylindrical prestressed concrete piles, traced the development of prestressing strands and recounted the evolution of precast concrete roof decking. I then explained the need for standardization in design and materials and discussed Erickson's contribution to the industry and the dissemination by PCA of prestressed concrete design criteria and engineering design aids.

In this issue I report one more major problem, fire resistance of prestressed concrete, and then give an account of developments in the industry on the East and West Coast after the construction of the Walnut Lane and Arroyo Seco bridges.

Lastly, a chronological listing of the major events which influenced the practical development of linear prestressed concrete is given at the end of the paper.

* * *

Over the centuries Americans have had, with good reason, a fear of fire and its disastrous effects. Since lumber was the principal basic construction material for a very long time, and still is so in single family residential dwelling construction, this fear of fire is understandable. Fire has destroyed widespread areas of many cities in the United States, such as in Chicago on October 8, 1871, downtown Baltimore in 1904, and San Francisco in 1906.

It is no wonder, then, that from the very beginning precasters recognized

In this last continuation of the concluding paper, the author once again pulls together the various threads of history spun in previous parts of this series and fills in the gaps still left in the story of the early years of the precast prestressed concrete industry.

the importance of being able to provide a fire resistant material. They knew that heat would anneal cold drawn wire, thereby reducing its strength; therefore, prestressed concrete structures could be weakened in a fire. Reduced to its simplest form, the question was: could a prestressed concrete structural member withstand the effects of fire without collapse?³⁷

While American precasters were groping for useful answers, fire tests of prestressed concrete were already underway in Europe, particularly in Great Britain. The results of these early tests were inconclusive.

Insofar as can be determined, the first fire tests in America were conducted in 1953, when the National Bureau of Standards, then in Washington, D.C., tested six post-tensioned concrete beams. These tests were part of a series sponsored by the British Joint Fire Research Organization and the Building Research Station,³⁸ and were designed to determine if scale models could be used to predict the behavior of full scale prestressed concrete elements exposed to fire.

The specimens were made in England. However, because of the size, shape, and type of prestressing, the results, though interesting, were not easily translatable into data useful for the types of prestressed concrete members commonly being manufactured in America.

By the mid-fifties questions regarding the fire resistance of prestressed concrete had been raised by building officials, insurance underwriters, engineers, and architects, as well as precasters. The matter continued to be pressed, but unfortunately no one was able to provide a reliable answer. Precasters had no choice but to conduct their own tests.

I know of at least two "back yard" fire tests which were conducted on double-tee specimens: one in Florida and the other in upstate New York. Unfortunately, there is not any data available about the former except that a fire was built under a double tee. However, the New York test conducted on November 21, 1955, yielded clues to the factors which influence the behavior of a prestressed concrete element under fire.

This test was directed by, and carried out under the supervision of, a young plant engineer working for the Frontier Dolomite Corporation, W. Burr Bennett, Jr., who later became PCI's executive director. The introduction to his report states:

"The purpose of the demonstration was to introduce to architects, engineers, and contractors pretensioned prestressed concrete floor and roof sections, and to demonstrate their performance, safety factor and the predictability of this material."

In addition, a fire test was conducted to determine the double tee's behavior

under fire. The table shown as Fig. 33 compares the behavior of the double tee with that of an adjacent bar joist when both are under fire.

The fire test report, signed by Bennett, stated that the steel section failed at between 11 and 12 minutes while the double tee section was still holding its load after the fire was out, 114 minutes later, with a 1.26 ft (384 mm) deflection and no collapse. A great deal of spalling had occurred on the underside of the double tee, undoubtedly partially due to the high moisture content of the member. Since its manufacture, this particular double tee had been stored in the open yard, exposed to the atmosphere, a situation which would not prevail under normal "in building" circumstances.

A graph of the fire test deflections showed a great temperature differential between top and bottom of the double tee. This was of particular interest, since the flame was swiped across the bottom of the slab by the chimney action of the concrete pipe over the holes through the slab. While this was not a rigid fire test, and no formal fire ratings could be safely derived from the data, the test, as run, probably presented a set of conditions far worse than any possible fire conditions that could occur in a normal structure. The double tee apparently had enough fire resistance to carry its design load through severe fire conditions.

Three important factors which were to affect the magnitude of fire resistance were pinpointed: the amount of cover over the prestressing steel; the moisture content of the member; and the shape of the member, which would affect heat transfer. A few years later, after several additional fire tests had been carried out, Armand Gustaferra would perceive a fourth factor which was to be the key to the development of a rational design approach to fire ratings of prestressed concrete members.

The full report of this non-scientific "back yard" test testifies to the thought-

fulness and care given to this test, a first in an area of research for which there was very little, if any, precedent. It augured well for the extensive fire studies yet to come, since it showed the seriousness of mind of those who had become involved in the new and sophisticated construction material, prestressed concrete.

In contrast to so many other industries where planning and programming are strictly at the management level, it must be noted that in the prestressing industry it was, and to some degree it still is, the practical man in the prestressing yard who has been eager for knowledge, and who coaxed and prodded the "learned professions." True, it was a self-serving interest and a matter of survival, but nevertheless the desire for knowledge was unusually strong. Producers were an impatient breed, always in a hurry, and consequently construction was ahead of theory.

The turning point for fire research came in 1955. Thor Germundsson, manager of PCA's Structural Bureau, was asked to present a paper at the First PCI Annual Convention in Fort Lauderdale, Florida (1955). Thor assigned Armand Gustaferra to prepare the paper, since he was the newest member of the Structural Bureau. The paper was to be entitled "Fire Resistance of Prestressed Concrete." That indeed was Gus' baptism of and by fire! Little did Gus realize at the time what he was getting himself into!

The questions being raised about prestressed concrete and fire did not subside. On the contrary, the clamor for answers persisted and intensified. During the 1957 PCI World Conference in San Francisco, several PCI members concerned about the fire problem met at a bar in the Fairmont Hotel. Those present included Forest Burtch of John Roebling and Son's Company, Pete Verna of Concrete Materials Inc., Ed Rice of T. Y. Lin and Associates, Ross Bryan of Ross Bryan and Associates, Paul Rosenthal

**FRONTIER DOLOMITE CONCRETE PRODUCTS CORP.
LOCKPORT, N.Y.**

JOB NO.	PAGE NO.	APPROVED	FIRE TEST R10046 DOUBLE TEE PRESTRESSED CONCRETE ROOF SLAB & NO. 120 STEEL BAR JOIST WITH STEEL DECK
NOTE NO.	DESIGNED BY		
DATE Nov. 21, 1955	CHECKED BY		

R10046 — SPAN = 30'-0" — DEPTH = 10"
DESIGN LOAD = 35 PSF ACTUAL = 35 PSF
#120 BAR JOIST — SPAN = 20'-0" ON 24" CTRS. W/STEEL DECK
DESIGN LOAD = 53 PSF ACTUAL = 35 PSF

Time In Minutes	R10046 Deflection In Ft.	Bar Joist Deflect In Ft.	Time In Minutes	R10046 Deflection In Ft.
1	0.00'	0.00'	29	0.55'
2	0.03'	0.00'	30	0.56'
3	0.03'	0.01'	31	0.57'
4	0.04'	0.01'	32	0.58'
5	0.04'	0.02'	33	0.59'
6	0.05'	0.03'	34	0.60'
7	0.05'	0.04'	35	0.61'
8	0.06'	0.05'	36	0.62'
9	0.07'	0.08'	37	0.63'
10	0.08'	0.13'	38	0.64'
11	0.09'	0.29'	39	0.66'
12	0.09'	0.47'	40	0.67'
13	0.09'	↓ Steel Failed Between 11-12 Min.	41	0.69'
14	0.10'		42	0.71'
15	0.11'		43	0.73'
16	0.13'		44	0.75'
17	0.16'		45	0.77'
19	0.19'		46	0.79'
20	0.22'		47	0.82'
21	0.26'		48	0.84'
22	0.33'		49	0.86'
23	0.37'		50	0.87'
24	0.41'	51	0.91'	
25	0.45'	52	0.92'	
26	0.48'	53	0.94'	
27	0.51'	54	0.96'	
28	0.53'	55	1.00'	

FIRE OUT 114 MIN. DEFL. = 1.26'

Fig. 33. Fire test of double tee prestressed concrete roof slab and No. 120 steel bar joist with steel deck, Nov. 21, 1955.

DATE OF TEST: April 3, 1958
 PLACE OF TEST: Underwriters' Laboratories, Chicago, Illinois
 SECTION TESTED:

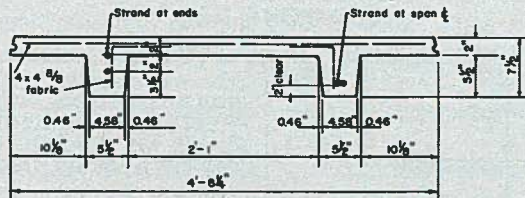

PRESTRESSING REINFORCEMENT: Two $\frac{5}{16}$ -in. high tensile strength strand per stem. Pretensioned.
MINIMUM CONCRETE COVER: 2 inches
AGGREGATE: Natural sand and crushed limestone coarse aggregate.
LOAD DURING TEST: One design live load (40 psf)
TEST SPECIFICATIONS: Standard Methods of Fire Tests of Building Construction and Materials ASTM E119.
PERTINENT TEST DATA: Span, 17 ft. 3 in. c-c bearings. Assembly width, 14 ft. 1 in. Spalling of stems occurred from 8 to 20 min. to a depth of 1 in. Centerline deflections: 1.98 in. at 1 hr.; 3.18 in. at $1\frac{1}{2}$ hr.; 4.33 in. at 2 hr. Load was maintained for 96 hr. after test. Temperature of strands with minimum cover at end of test: 1250°F maximum; 1150°F average.
REPORT: Underwriters' Laboratories, Inc., Retardant R4123-1, May 12, 1958, "Floor or Roof Construction Consisting of Prestressed Concrete Double-Tee Slabs."
DURATION OF TEST: 2 hr. 1 min. exposure. Structural end point not reached. UL provides label service for 2-hr. rating for slabs with 3-in. non-structural concrete topping. (5 in. total thickness).

Fig. 34. Test data for testing of first commercially made prestressed concrete element.

of Crest Concrete, Inc. and Armand Gustaferra of Vulcan Materials, Inc., Chicago (where he was in charge of the casting of girders for the Illinois Tollroad Commission).³²

During that "session" the PCI Fire Committee was born; the aforementioned group became its members. Several of the group felt that one test at the Underwriters' Laboratory (UL) would solve the fire problem and the committee could then be discharged. How naive we all were in the days of our youth! And how strange that so many momentous and far reaching decisions are made either in hospitality rooms at conventions, at bars or on golf courses—maybe because we then lose some of our inhibitions and become brave. The committee elected as its chairman Forest Burtch, a man with a sound, practical

and analytical mind. He grasped the problems at hand, and calmly and logically placed them all in proper perspective, allowing the achievements of their solution; remarkable, because his background had not been in "fire."

Paul Rosenthal volunteered to cast three double tees in his plant near Chicago and have them shipped to the Underwriter's Laboratories, Inc. in Chicago for testing. Countless hours were spent by the committee in order to arrive at a logical testing program, the cost of which had to remain within PCI's allocated funds.

Finally, the great "fire" day, for which so many had prayed and struggled, arrived. On April 3, 1958, the first scientific fire test on a practical prestressed concrete product was made. Fig. 34 gives succinctly the basic data and test re-

sults. The subsequent Report No. R4123-1, dated May 12, 1958, prepared by the Underwriters' Laboratories, was the first of many such reports (Fig. 35).

While the test results for this particular tee were gratifying, the practical result was disappointing to the industry. The Laboratories would only provide label service for 2-hour ratings for double tees made with limestone aggregates, certain minimum dimensions, and a 3-in. (76.2 mm) nonstructural topping, for a total thickness of 5 in. (127 mm).

The listing was thus quite narrow—promising, but not good enough. UL declined to extrapolate the test results to make them applicable to different tees. In retrospect we must admit that they were probably right.

As a result of all this, the Fire Rating Committee had no choice but to embark on a continuing program of fire tests and to broaden the coverage. The committee, through PCI's Board, had literally to beg for the additional funding necessary for the vital but costly fire testing program. The precasters came through, however, and over a period of years PCI has sponsored more than 21 fire tests at the Underwriters' Laboratories.

The first fire test had literally "fired" the imagination of many industry people. The same year, a UL fire test was conducted on "Spancrete" hollow-core slabs, sponsored by their manufacturer, Henry Nagy. Subsequently, nearly all of the many hollow-core slabs made in America were fire tested.

Also in 1958 (it was a busy year for fire tests of prestressed concrete), the Portland Cement Association began construction of its fire research laboratory, probably the finest in the world (Figs. 36, 37, and 38). Through the years it has been monitored by some of the most capable and brilliant American engineers.

It is not sufficient to have a fine, unique laboratory furnace and a good product fabricated by a knowledgeable precaster. In the final analysis, in order

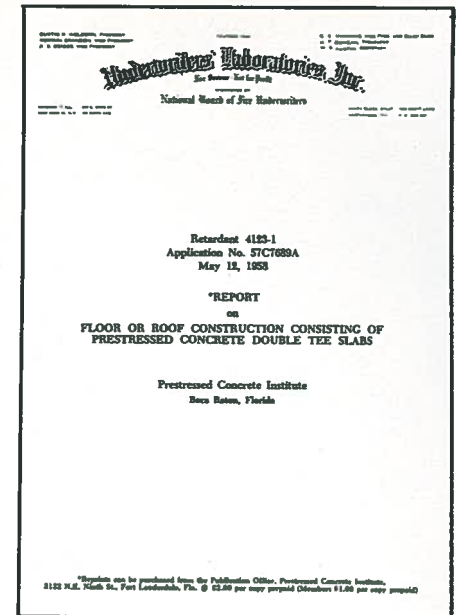

Fig. 35. Cover of Underwriter's Laboratory report on first testing of a commercially manufactured prestressed concrete element.

to obtain results which will be of practical use to the industry, engineers must study, analyze and, above all, be able to interpret accurately the results of fire tests of prestressed concrete.

Gustaferra—The Authority on Fire

Armand H. Gustaferra, Gus to all who know him, was a member of PCI's Committee on Fire Resistance Ratings from its very inception in 1957. He later served three terms as chairman of the Committee. Gus was educated under Hardy Cross,* and put all that this fam-

*While at the University of Illinois at Urbana, Professor Hardy Cross had developed in the early thirties the design-analysis method known as "Moment Distribution." During the next 30 years (until the advent of electronic computers) Cross' method became the standard technique for designing and analyzing indeterminate structures.



Fig. 36. PCA's fire test center.

ous and extraordinary teacher taught him to work, both on the PCI Committee and at PCA's Fire Research Center at their Research and Development Laboratories in Skokie, Illinois, where he had accepted the position of Manager in 1965 (see Fig. 39).

After having been instrumental in some of the early fire tests at PCA's Fire Center, Gus discerned one of the main factors in the behavior of a structural element under fire. I still remember very vividly the evening I spent in his living room in Chicago, around 1960 (it now

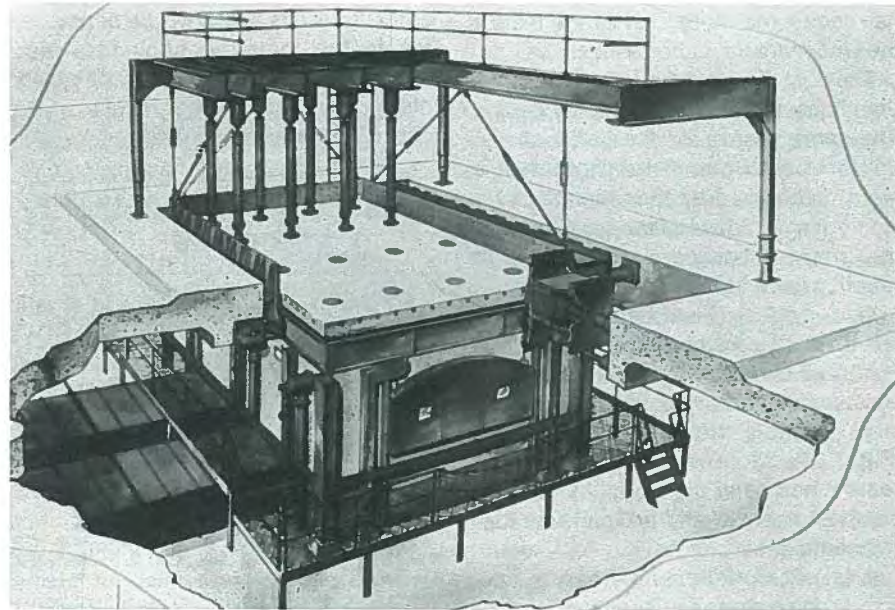

Fig. 37. Cut-away of furnace of PCA's fire test center which can accommodate up to 60-ft long members. A unique facility in the world.



Fig. 38. Operating console in PCA's fire test center.

seems like eons ago!), when Gus thought that he had it all pieced together. He used me as a sounding board, explaining that he and other researchers had learned that factors other than thickness of concrete cover also affected fire endurance. Several factors had minor influences: load intensity, type of aggregate, size and shape of member, and moisture content. But, in his opinion, one particular factor overshadowed all of the others: *the effect of end restraint due to thermal expansion.*

Based on the various fire tests he had directed, supervised and witnessed, he had come to the conclusion that the specific conditions under which a given fire test was made affected the behavior of an element and its mode of failure. Up until this time, all American fire tests of floor and roof assemblies had traditionally been conducted with specimens held in rigid restraining frames. As a specimen becomes heated it tends to expand and push against the frame in which it is held. In turn, the frame pushes back and, in effect, exerts an

external prestressing force on the specimen.

In this condition, the fire endurance is almost always governed by the criteria for temperature rise of the unexposed surface rather than by structural considerations. If, however, the restraint is so great that no expansion is permitted to occur, the specimen is likely to fail in compression. In real buildings, however, some movement of the restraining elements will always occur, thereby reducing the restraining force to a level that can be accommodated. Gus felt that this was the factor that explained the apparent inconsistencies observed when one fire test has been compared with another.

As the evening went on we really got carried away by this new perspective. At the end, we were exhausted but jubilant. Gus had found the key which enabled him and his staff to develop the necessary design curves and rational design procedures applicable to prestressed concrete members subject to fire, and to predict the behavior of such members. "An Interpretation of Results of Fire

Tests of Prestressed Concrete⁴⁰ describes Gus' findings.*

From this point on it was relatively easy sailing. PCA and others continued with their fire testing programs, confirming and amplifying Gus' findings, some of which are described in Reference 41.

Eventually, Gus was deservedly awarded the FIP Medal (Fédération Internationale de la Précontrainte) and in 1979, PCI's Medal of Honor.

MIT Conference (1951)

This history would be incomplete if I did not mention the three-day conference sponsored by the Massachusetts Institute of Technology and six cooperating organizations in August 1951.⁴² It was one of the most animated meetings which I ever attended; pro and con discussions were held long into the hot night in corridors, lobbies and dormitories. Some 600 men representing all phases of the construction industry met in shirtsleeves and listened to the *avant garde* describing the new, practical uses for prestressed concrete.

Material shortages as well as the possibility of building better, safer structures at lower cost focused attention on this first United States conference on prestressed concrete.⁴³ The conference clearly showed that American engineers and contractors had accepted Europe's challenge and were adapting this new development to the American way of doing things.⁴⁴

In his closing address, Rear Admiral I. F. Jelley, then chief of the Navy's Bureau of Yards and Docks, said:

*For those who are interested in U.S. experience with actual fires, PCI has published a 46-page paper entitled "U.S. Experience with Fires in Prestressed Concrete" by Russell J. Hammersmith. It was presented at the International Meeting of the Ad Hoc Committee on Fire Resistance in Braunschweig, Germany on June 9-11, 1965. It reports on 15 actual fires, all fires then known to the author which had occurred on prestressed concrete before the summer of 1965.

This conference has given me the feeling that we are on the threshold of a new era in construction very similar to the time 50 years ago when reinforced concrete was introduced. Unquestionably, we are in the initial stage of developing an important construction material, one whose ultimate development may exceed our present expectation . . . we cannot help but be stimulated by this challenge.

I believe it is fair to say that this prophecy of 28 years ago has been fulfilled.

Post-Tensioning in the East After Walnut Lane

In Part 5, Ted Gutt describes in detail his tribulations with post-tensioning on the West Coast and in the Middle West in the early fifties. In the meantime, what was happening in the East?

Prompted by the excitement and expectations brought about by the construction of the Walnut Lane Bridge (Part 1), the Tennessee block-beam bridges (Part 4), the Tampa Bay Bridge (Part 2) and the Arroyo Seco Pedestrian Overpass in far away California (Part 5), Freyssinet headquarters in Paris had decided to take the plunge and open up an office in New York City. It was logical for Freyssinet to set up a business in the United States in view of its excellent relationship with Raymond Pile Company, which was already using a modified Freyssinet cone anchorage for its piles (see Part 9, January-February 1980 issue of PCI JOURNAL).

The goal was three-fold: to promote the Freyssinet post-tensioning system for use in the United States, to offer engineering services for pre- and post-tensioning designs, and to advise concerning the construction of plant facilities for the production of pretensioned products. Freyssinet, as well as Harry Edwards and Ross Bryan,[†] recognized the need

[†]Later they were joined by Irwin Speyer in this outlook.

of the American market for assembly-line production methods, and entered into an active period of plant and product design.

Often they competed with each other, and equally often, learned from each other. "Affiliate Programs" were established by these various consultants, in which technical and financial information was exchanged among producers within each group. The high level of technical exchange significantly contributed to the growth of the young industry, and formed the basis of what is now the PCI.

The late Randall M. (Mike) Dubois* was president and executive officer of the New York branch. To assist him, Freyssinet's main offices in Paris assigned to work in New York two brilliant French engineers experienced in concrete work, Jean Muller[†] and Niels Thorson.[‡] Soon thereafter, two excellent and capable American engineers joined the firm: Irwin Speyer,[‡] and Gene Smith, who was to become very active in the firm of Intercontinental Equipment of New York City, the materials and equipment firm which was associated with the U.S. Freyssinet firm.

If the expectations for the firm's work had been great, the disappointments must have become equally so. Acceptance of post-tensioning was slow in contrast to that of pretensioning, which was progressing by leaps and bounds. This was in spite of the fact that Freyssinet's staff in New York was most competent and could always rely on the main office in Paris for assistance if necessary.

The lack of progress was due primarily to factors emerging from a clash in construction philosophies. The American preference for assembly line production and pretensioning slowed the use of post-tensioning, which is much more suitable for on-site construction. Also, unlike pretensioning, which is available to anyone, post-tensioning then involved licensors, licensees and royalty payments. Traditionally, American contrac-

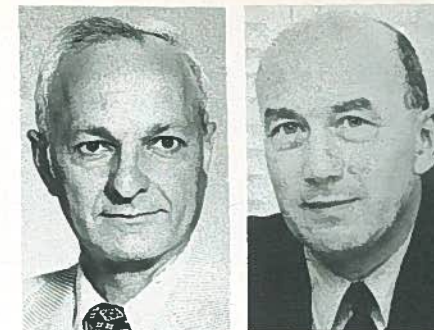

Armand Gustafiero Jean Muller

tors have been most reluctant to pay royalties for anything: they are not used to making royalty payments as are Europeans.

American contractors have found that the way to be low bidder is to plan their work around novel construction methods for each individual project. Of the three basic items which make up a contractor's bid—labor, materials and efficiency of operations—the only element which is truly competitive is efficiency of operations, since labor rates and cost of materials are almost the same for all contractors. Efficiency of operations will depend on the construction ideas the contractor himself and his staff can generate. Very often some of these ideas have been original enough to be patented, although the contractors would not hear of it. So why pay royalties?

*President PCI, 1959-1960.

[†]In 1953, *Engineering News-Record* featured Jean Muller in one of their articles as, at age 28, the youngest and most promising engineer. True to the prediction, Jean Muller is now chairman of the Board and president of the consulting engineering firm, Figg and Muller Engineers, Inc. and has been responsible for the design and construction in the United States of several innovative segmental prestressed concrete bridges.

[‡]Niels Thorson returned to Denmark, where he now heads up the world renowned construction firm of Monberg and Thorson.

[‡]Mr. Speyer was for many years a member of the PCI Building Committee and a founding member of the Connections Committee. Today, he still participates vigorously in many PCI activities.



Fig. 39. 1958 PCI Convention, Miami, Florida: from left to right—Armand H. Gustafiero, authority on fire; Pete J. Verna, member of Fire Resistance Rating Committee; Charles C. Zollman, chairman, Technical Activities Committee; Colonel Horn; Senator Gore of Tennessee, keynote speaker; Mike Dubois, PCI President-Elect; George Ford, PCI President.

This philosophy can best be illustrated by mentioning the experience I had with Vacuum Concrete, Inc. Vacuum Concrete derived most of its income from royalties on the use by contractors of the vacuum process and the vacuum lifter described previously; the amount ranged from \$0.02 to \$0.10 per sq ft (\$0.21 to \$1.07 per m²), depending upon the size of jobs and other such factors. Contractors were so reluctant to pay even these small royalties that they eventually circumvented the use of the vacuum method, developing a lifter based on the ice-tong principle. It worked so well that it nearly put Vacuum Concrete out of business and me out of a job! "Necessity is the mother of invention." How true!

Since span and load capacities possible in pretensioning increase in proportion to increases in strand sizes, pretensioning (eventually) was able to compete with post-tensioning in areas considered until then to be exclusively post-tensioned territory.

The operational field for post-tensioning thus narrowed, becoming limited to cast-in-place construction for long spans and special structures, or to use for special conditions such as cast-in-place flat slab construction, rock anchors and similar structures.

Another deterrent to the use of post-tensioning in the early fifties was that

there was more work for contractors than they could handle. Therefore, why should they bother with a construction method about which they didn't know all that much? Whenever a new construction concept is introduced, there is a costly, time consuming apprenticeship period. Many contractors were interested solely in immediate returns, few in the long range returns.

And finally, to make matters even more difficult for the post-tensioning method, there was the attitude of the structural steel industry. At first it made light of prestressed concrete as a construction material and simply continued the production of its standard A-7 structural steel, which it had started years before. With no competition except within the steel industry itself there was no incentive to produce any other type of quality steel and their research and development program was about nil. However, eventually steel began to lose ground to pretensioning, particularly in Pennsylvania where the production of the standard 3 and 4 ft (0.9 and 1.2 m) wide prestressed concrete box beams increased rapidly much to the irritation of the steel companies.

The steel industry, with huge steel mills in Pittsburgh and Bethlehem, considered Pennsylvania its "private" domain: nothing, but nothing, not even prestressed concrete, was going to in-

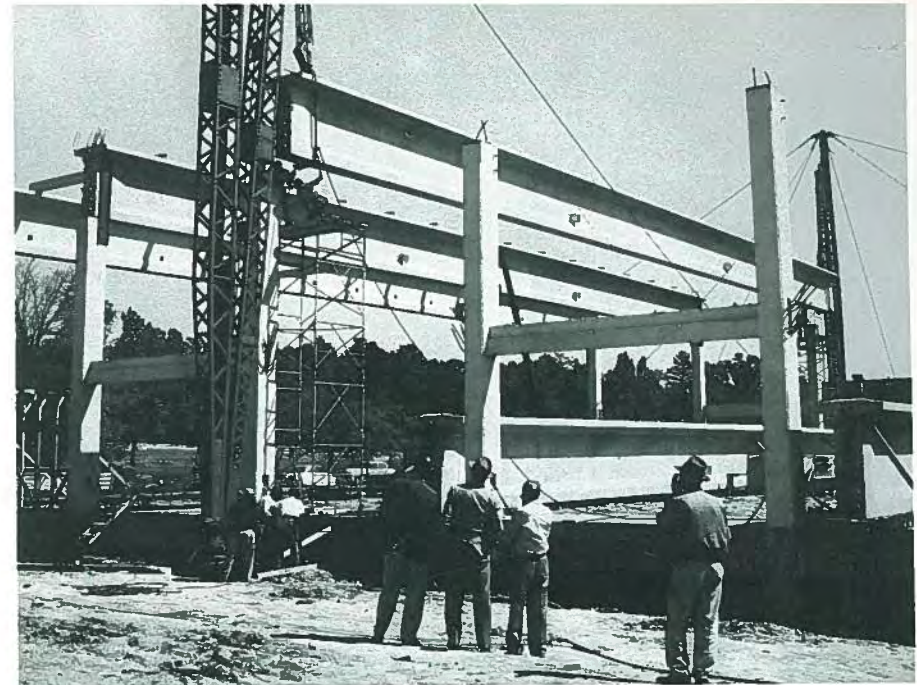

Fig. 40. Girder No. 3 almost in position over columns. The column cables are being pulled up in order to thread them through holes in the girder ends.

vade what it considered to be its exclusive territory. In the late fifties construction documents for the Spring Garden Street Bridge, to be built in the heart of downtown Philadelphia and facing the city's illustrious Art Museum, were prepared for both a structural steel design (continuous welded steel plate girders) and a prestressed concrete design. Although structural steel won out as low bidder, its per-pound cost positively nose-dived!¹⁶

To regain ground, members of the steel industry found it prudent to reinvigorate their research and development departments, as mentioned in Part 5. This resulted in the later marketing of an entire series of high strength steels with yield strengths just about double that of the A-7 steel. The new grades marked the end of the long use of A-7 steel.

The then tiny prestressed concrete industry had every right to be proud of

having been able to prod in the pocket, and not too gently at that, the mighty steel industry; forcing it to develop these excellent new high strength steels which, though resulting in stiffer competition for the prestressing industry, have significantly benefitted us all.

Notwithstanding all of these difficulties, firms such as the Freyssinet, Inc. company and the Stressteel Corporation were determined to develop markets for the post-tensioning process. Because of their tenacity, they were successful even in the early days, and many post-tensioned structures were built.

¹⁶"Yes" I was told some time later when visiting Bethlehem Steel's fabricating plant in Pottstown, Pennsylvania, where the huge steel plate girders for the bridge were being fabricated. "Some outfit designed a concrete alternate and we had to beat the sons of b . . . s." And the plant superintendent, not knowing who I was, continued, "We will be d . . . d lucky if we break even." I must admit it made me feel good.



Fig. 41. All prestressed girders in place for Greensboro, North Carolina, Senior High School gymnasium.

Just to name a few:

■ Greensboro High School, North Carolina:⁴⁵ Post-tensioned girders of long spans were used in the construction of this school building in 1954 (Figs. 40 to 43). Cast on the floor of the gymnasium, these girders were 120 ft. (36.6 m) long, 6 ft (1.8 m) deep and their weight was 63 tons (57.1 t) each.

■ Pier 57 in New York Harbor: Post-tensioned pile caps served to squeeze together all the pretensioned deck stringers (Fig. 44) so that they acted somewhat as a single slab beam. The pile caps were placed 21½ ft (6.6 m) on centers and received 1 ft (305 mm) deep pretensioned stringers,⁴⁶ 2½ ft (0.76 m) wide and 19½ ft (5.94 m) long designed to carry a 600 psf (28.7 MPa) live load. The pier was built in 1952.

■ Shawan Road Bridge in Maryland: Built in 1953, it was the first post-tensioned structure in that state. Girders 5 ft (1.52 m) deep, with top flanges 3 ft 8 in. (1.14 m) wide, were placed 4 ft 1¼ in. (1.22 m) on centers. After the gap was

closed by cast-in-place concrete, the bridge was laterally post-tensioned.

■ Experimental project in Massachusetts: This was constructed in 1952 and consisted of using four different post-tensioned anchorage systems (Fig. 45). Fig. 46 is an analysis of the low bid for the four systems.⁴⁷

John Rundlett was chief bridge engineer for the State of Massachusetts, and a strong advocate of the then new method of construction. Even after retirement he continued his interests, working with New England Concrete Pipe Co. along side of Bob Bierweiler, promoting bridge construction in the Northeast.

These and similar structures were the forerunners of today's sophisticated post-tensioned structures such as prestressed concrete containment vessels, deep sea mining vessels, and complex prestressed concrete sea structures providing a complete system for drilling, production, storage and off-loading of crude oil. Such structures would not have been possible without post-ten-



Fig. 42. Completed gymnasium with 120-ft clear span.



Fig. 43. The "driving forces" at Arnold Stone Co. surrounded by visiting dignitaries. From left to right: M. J. Andrews, Arnold Stone Co.; W. D. Shea, chief engineer, Arnold Stone Co.; A. Brandestini, BBR, Zurich, Switzerland; M. A. Arnold, president, Arnold Stone Co.; Millard Warren, Southern Cast Stone; Otto Formigli, Formigli Bros., Berlin, New Jersey; C. Hansen, engineer, Washington, D. C.; and Shelborne Warren, Hamilton Concrete Products.

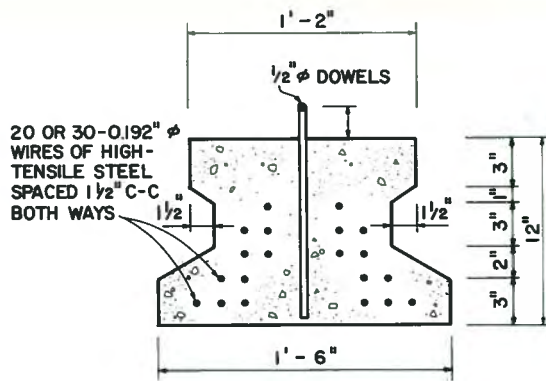
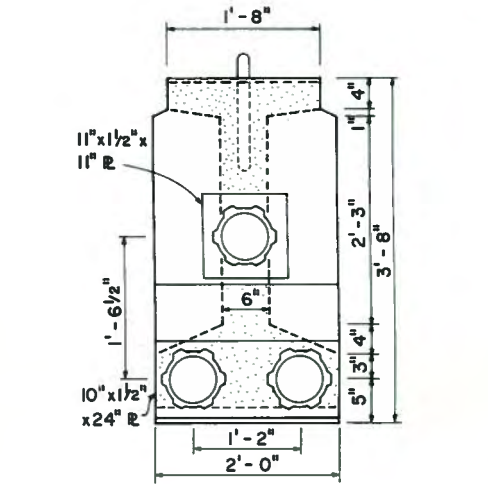
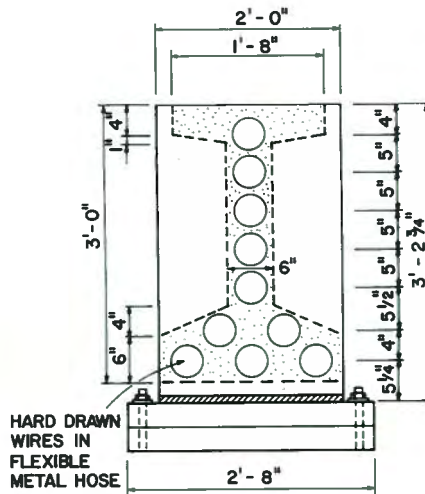

Fig. 44. Typical 1952 stringer pretensioned with 0.192 in. diameter wires for New York's Pier 57.

Fig. 45 (below). In 1952 four methods of prestressing were specified for four bridges by the Massachusetts Department of Public Works.



ROEBLING METHOD



FREYSSINET METHOD

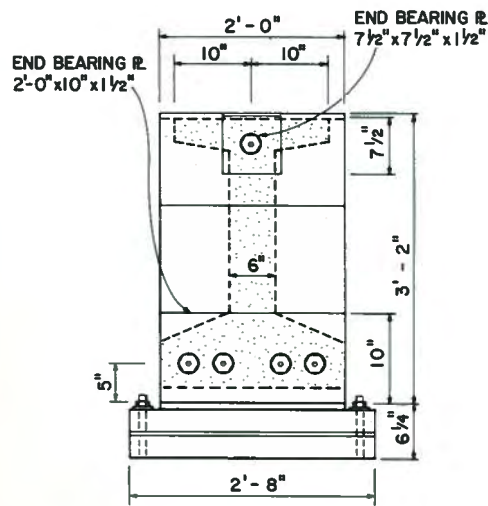

LEE-McCALL METHOD

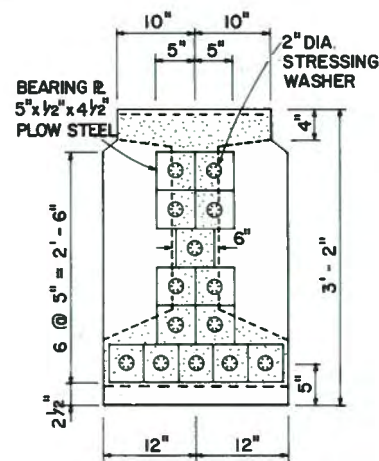

PRESTRESSED CONCRETE CORP. METHOD

Analysis of low bid for prestressed beams								
	Span	Loading	Bid per Beam	Concrete per beam — cu yd	Initial Tension per beam—kips	Cost per cu yd	System	
Scotland Road.....	65.95'	H-20-S-16	\$1,722	8.74	513	\$197	Roebbling	
Hale St.....	65.02	H-20	\$1,455	7.87	470	\$185	Freyssinet	
Sprey Ave.....	58.45	H-20	\$1,345	7.18	450.6	\$187	Lee-McCall	
Pine Hill Rd.....	59.27	H-20	\$1,649	7.30	427.2	\$226	Prestress Concrete Corp.	

Fig. 46. Cost analysis of low bid for prestressed beams shown in Fig. 45.

sioning or without the men of courage and imagination who began it all.

Further Post-Tensioning Developments in the West*

In 1896, Henry Jackson started producing prestressed concrete lintels in San Francisco to be used in connection with brick buildings. Although they were initially successful, the lintels cracked and deflected after 2 or 3 years, due to creep of the low strength concrete then being produced and stress relaxation of the low strength steel, the only kind of steel then manufactured. But since creep of concrete and stress relaxation of steel were then not understood,† Jackson was discredited and died in disgrace.

Around 1900, a contemporary of Jackson, Ernest L. Ransome, pioneered reinforced concrete construction in the United States, starting in San Francisco before moving to Boston. While in Boston, Ransome developed precast concrete, including tilt-up slabs and precast I-beams similar in form to the early prestressed I-beams of the fifties.

The Gerwicks—Father and Son

Ben C. Gerwick, Sr. was for a time Ransome's chief engineer. Around

*Based in part on data furnished by Ben C. Gerwick, Jr.

†The French engineer, Eugene Freyssinet, was the first to announce, in 1921 or thereabouts, that in order to maintain a prestress, concrete had to be of high strength in order to cope with the phenomenon of creep of which he had become aware, and steel also had to be of high strength to cope with the phenomenon of steel stress relaxation.



Ben Gerwick, Jr.

1910, Ben Gerwick actually tried to make prestressed concrete beams using wire rope, but the loosely stranded rope unwound under high loads, and the experiments were abandoned.

With his own and Ransome's experience, however, the stage was set for Ben C. Gerwick, Sr. to help develop precast concrete bridge deck slabs and precast concrete piling in Northern California, beginning in 1915. Eventually, during World War II, he set up a large precast concrete pile manufacturing plant at Petaluma, California, with Contractors Morrison-Knudsen.

At the conclusion of World War II, the plant had only a very limited market. Ben C. Gerwick, Jr. had by now joined his father's firm; one of his assignments was to find new products. Naturally, the construction of the Walnut Lane Bridge captivated Ben Junior's imagination and reignited Ben Senior's interest in prestressed concrete. By then, the Ben C. Gerwick firm was experienced in the

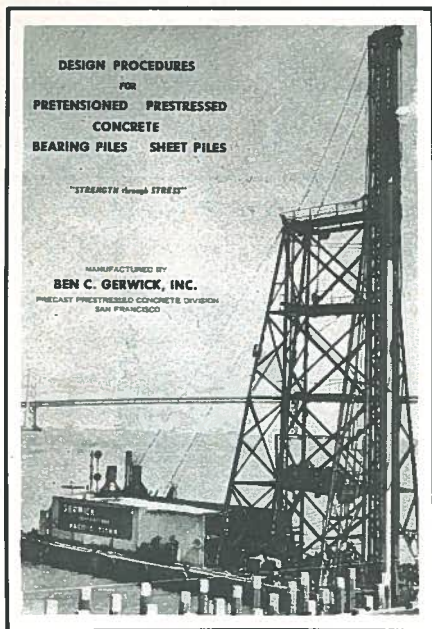

Fig. 47. Cover of pamphlet developed by Ben C. Gerwick, Jr. in 1956 for design procedure for pretensioned prestressed concrete bearing and sheet piles. Its impact on the pile industry was similar to that of Magnel's book on "prestressed concrete" on the prestressing industry. Twenty five years later the pamphlet is still in use throughout the world.

construction of waterfront structures, such as piles, sheetpiling and wharfs. It is obvious that the firm would direct its efforts to the application of the principles of prestressing to piles, particularly to long piles suitable for resistance against bending and driving stresses while being incorporated into major marine structures.

A series of tests were started. The firm's plant manager developed facilities for the production of a few pretensioned piles, ready for the first driving tests. At the first blow, the piles shattered: no stirrups or spirals had been provided! Undismayed, they redesigned the piles—this time with stirrups and spirals. Pro-

duction and driving tests continued and the problems were solved one by one.

By the mid-fifties, production began in earnest, with the first major contract being Pier 27 for the Port of San Francisco. Syd Gorman had had the courage to design, in contrast to the Raymond cylindrical pile, pretensioned non-cylindrical hollow-core piles up to 170 ft (51.8 m) in length, to be driven through riprap, muds and sands. The project was highly successful. With this triumph, the disadvantages of long, conventionally reinforced concrete piles (extreme care necessary in handling and driving because of possible cracking) became problems of the past.

The Gerwick firm then developed excellent and attractive design and construction pamphlets, complete with construction details, to present to potential pile users. The excellence and completeness of the presentations together with the high quality elements produced by the firm were instrumental in the rapid acceptance of these piles (Fig. 47).

Original sizes were 12 and 16 in. (305 and 406 mm) square with lengths varying from 50 to more than 80 ft (15.2 to 24.5 m). As experience and knowledge were gained, these were increased to up to 30 in. (762 mm) square (or octagonally shaped), with lengths varying from 75 to more than 170 ft (22.9 to 51.8 m). Eventually, methods for easy splicing were developed, as well as methods for increasing the length even further by means of structural steel WF beams embedded in the bottom of the piles.

California's Highway Department

Following the successful Arroyo Seco Overpass (see Part 5) and concurrent with the above described developments, California's Highway Department started to design some of its bridges in prestressed concrete under the direction of Arthur L. Elliott.* By 1956, 20 projects

*At the time, Bridge Engineer, Planning, California Division of Highways, Bridge Department.

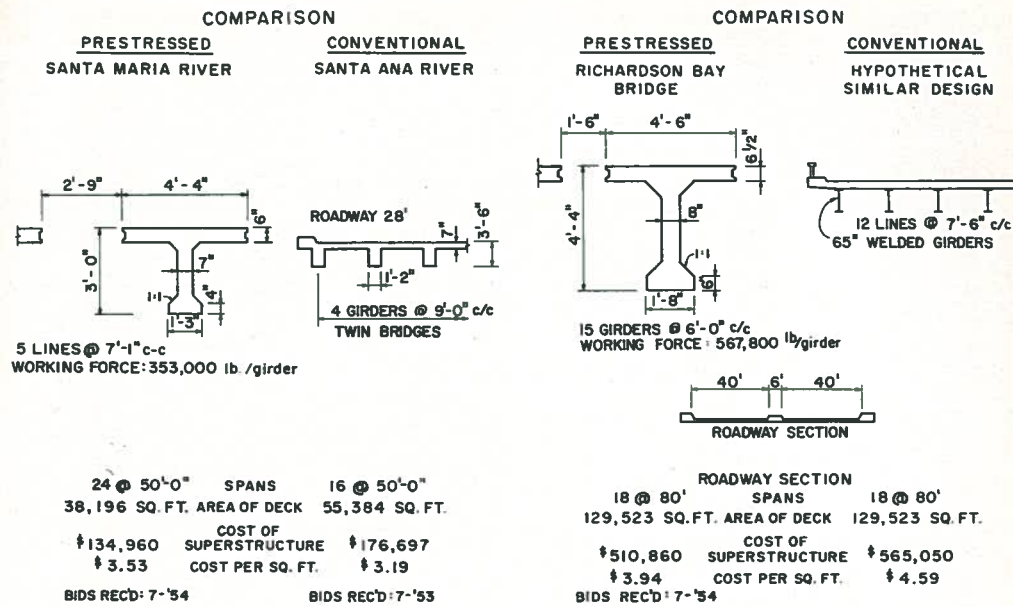

Fig. 48. Cost comparisons by California Department of Highways.

had been built using various prestressed concrete cross sections, such as T girders, inverted T sections, I girders, precast channel sections, box girders and slabs.

Elaborate comparative cost studies were made, as described in detail in Reference⁴⁸ but these were at best "difficult, confusing, and contradictory." Nevertheless, another 20 projects were designed in prestressed concrete for construction within the following 3 years.

An example of contradictory cost estimates is shown in Fig. 48. It should be noted, however, that in one case the project consisted of 24 spans at 50 ft (15.2 m) or 38,200 sq ft (3550 m²) of deck at \$3.53 per sq ft (\$38.00 per m²), and in the other of 18 spans at 80 ft (24.5 m) or about 510,860 sq ft (46,460 m²) of deck at \$3.93 per sq ft (\$42.30 per m²). A conventional concrete alternate for the former was \$3.19 per sq ft (\$34.30 per m²) and \$4.59 per sq ft (\$49.40 per m²) for the latter, a structural steel alternate.

Basalt Rock Company, with headquarters in Napa, California, headed by Al Streblow, later joined by his son Jack,* produced post-tensioned concrete bridge girders for some of the projects included in those cost studies. They also began production of pretensioned double tees using lightweight aggregates found in the region of Napa.

Professor T. Y. Lin

When Professor T. Y. Lin returned from Belgium (around 1954), he began actively designing bridges and buildings in prestressed concrete. About this time, Prof. Lin also started work on his book on prestressed concrete which when published became an extremely popular book in America both for students and young structural engineers.†

*PCI President 1966-1967.

†For more details on the career of Professor T. Y. Lin and his many contributions to the precast and prestressed concrete industry, readers should refer to the special T. Y. Lin Symposium on Prestressed Concrete (September-October 1976 PCI JOURNAL).

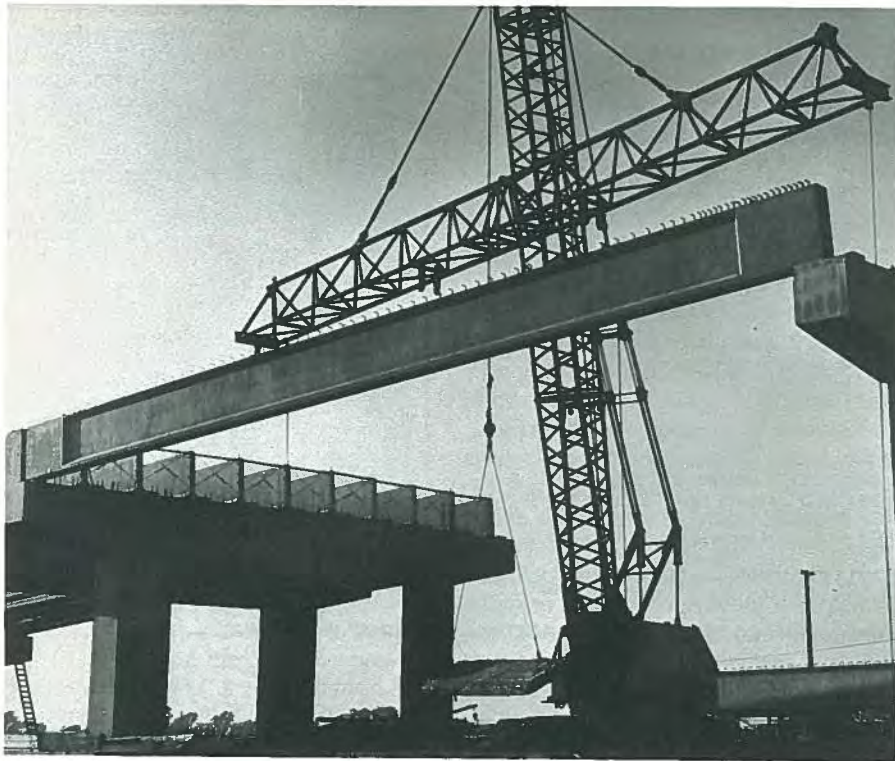

Fig. 49. Napa River Bridge, 1957: one of the earliest applications of prestressed deflected strands. Design by California State Department of Highways.

Further Developments

By the mid-fifties the Gerwick and the Basalt firms had begun the production of prestressed concrete elements and they decided to form, with Wailles, Rockwin and San Diego Prestress, a regional California prestressed concrete



T. Y. Lin

organization. In 1956, this was amalgamated with and merged into the newly-formed Florida-based, Prestressed Concrete Institute.

T. Y. Lin, the Basalt organization and the Gerwicks then conceived the idea of organizing a symposium to review the state-of-the-art of prestressed concrete and develop a market for prestressed concrete. Professor Lin, never one to think small, proposed that this be the First Prestressed Concrete World Conference, to be held in the United States. He enlisted as prime sponsor the University of California at Berkeley as well as the major American technical organizations including ASCE and ACI as additional sponsors. Those who attended this conference in 1957 will remember that it was a tremendous success, a

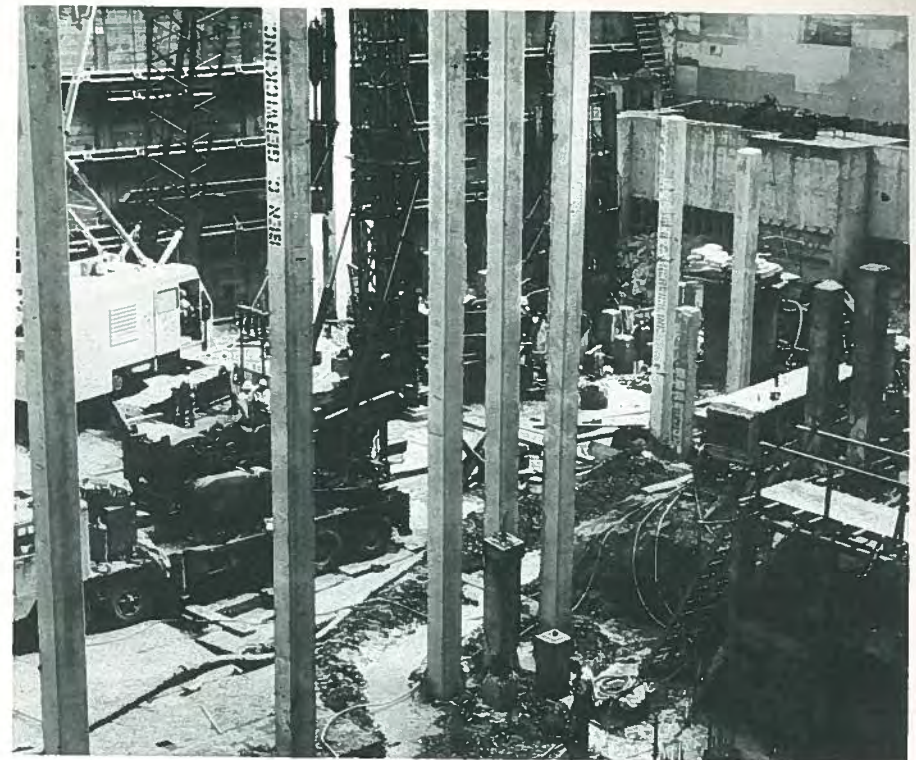

Fig. 50. Wells Fargo Building, San Francisco (1957): 138-ft long 20-in. square prestressed concrete piles.

stimulating event which brought together more than 1200 engineers from 30 countries, including for the first time engineers from the Soviet Union.

An immediate result of the conference was that a delegation of American engineers, which included Ben C. Gerwick Jr., and Prof. T. Y. Lin, visited the Soviet Union in 1958 to inspect Soviet research and development in the field of precast and prestressed concrete engineering.⁴⁹

About 5 years after PCI was formed in 1954, the joint AASHO-PCI Committee on Piles was organized, in 1959-60. Among its members were experienced engineers from the Ben C. Gerwick firm such as William Talbot, now chief engineer of Santa Fe-Pomeroy, and Robert Singer, past PCI President. Thus, the entire industry benefitted from the les-

sons learned from the driving of piles on the West Coast.

Many other individuals in the firm, such as Arnold Brown (current secretary/treasurer of PCI), Herbert Brauner (now plant manager), Ken Sylvester, and Hans Feibush were inspired by the Gerwicks' leadership. They were instrumental in the development of many innovations, a trademark of the Gerwick organization. Among these were:

- The first commercial prestressed deflected strand bridge girders. Note that experiments on such girders had been made in England previously (Fig. 49).*

*It was not possible to determine with any accuracy whether or not the first deflected strands in I-beams were in fact used as early as 1956 in the Nashville, Tennessee area.

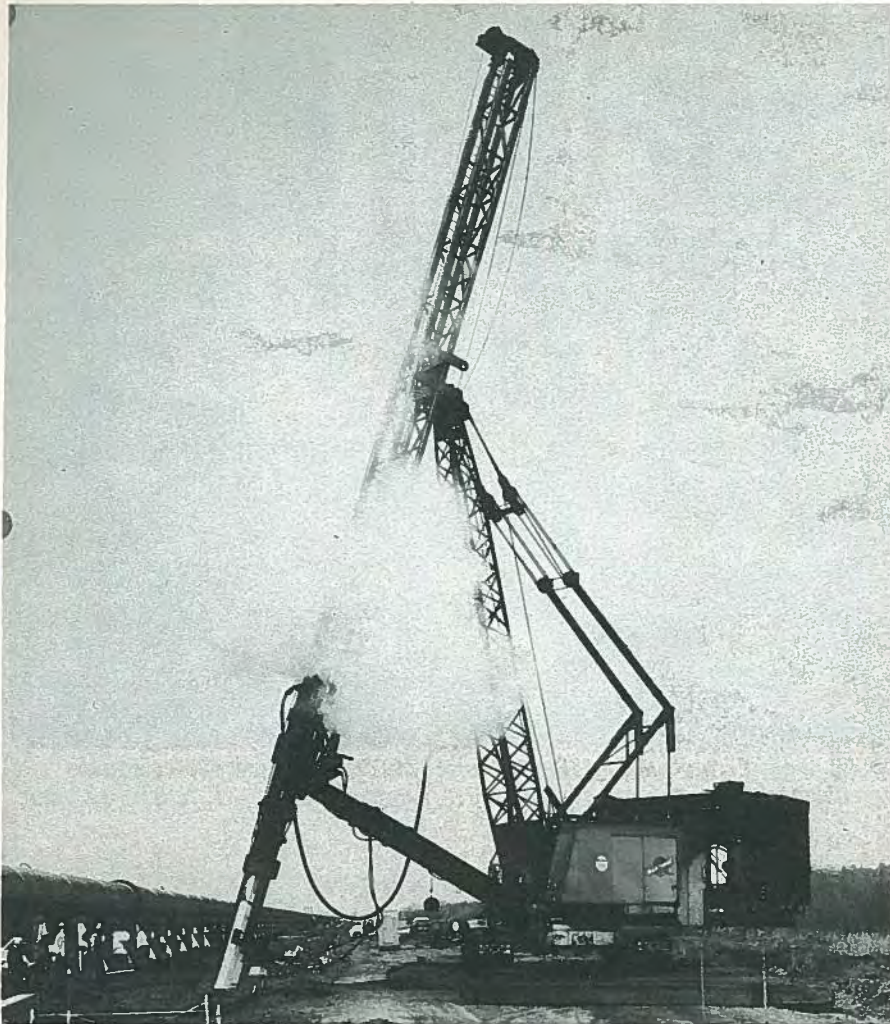

Fig. 51. East of San Francisco, 1966: driving of 5000 pretensioned concrete piles, all on a batter, to support 72 in. diameter steel water pipe across 10 miles of marshland.

- Pretensioned piles up to 175 (53.3 m) in length (Figs. 50 and 51).

- The first monolithic,* cylindrical, horizontally cast, pretensioned piles (Fig. 52). (About the same time, and independently from the Gerwick group, the

*The Louisiana piles were, in contrast, 16 ft (4.88 m) long pipe elements assembled and stressed by post-tensioned tendons. See Part 9, January-February 1980 PCI JOURNAL.

manufacture of such piles was begun at Lake Maracaibo in Venezuela.)

- The first pretensioned railway ties cast by the long line process. These have evolved into the ties being used for the Boston to Washington Amtrak line (Fig. 53).

- Application to the cantilever-suspended span concept for longer bridge spans on the Napa River Bridge, 1965. (About the same time, Bill Dean de-

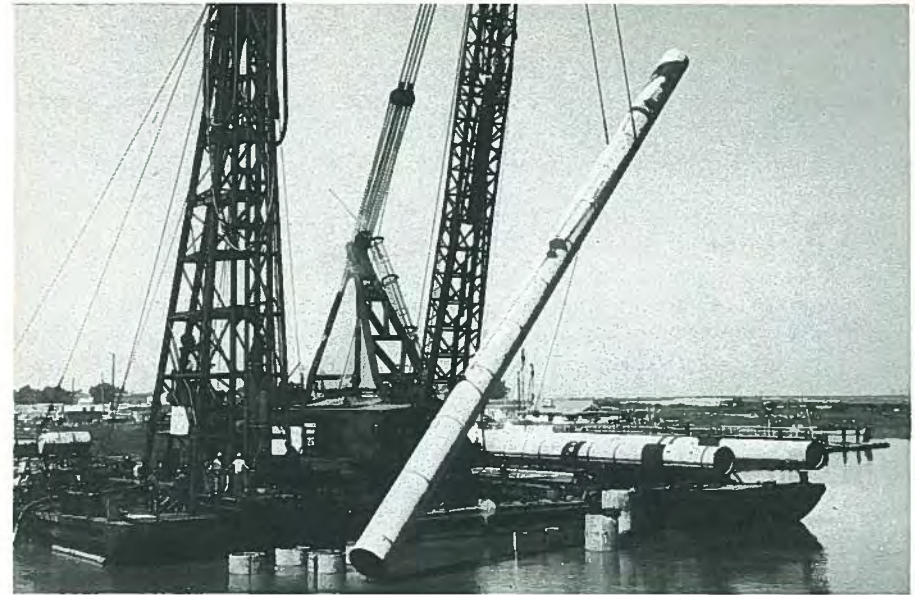

Fig. 52. Napa River Bridge, California: pretensioned monolithic cylindrical pile, 54 in. diameter, 120 ft long. It is believed to be the first such pile used worldwide.



Fig. 53. Gerwick RT-2 type cross-ties as installed into Bart track system at Hayward, California.

veloped the same concept for bridges in Florida.)

- Production for the first time of match-cast bridge girders on a short-line, incorporating super-elevation and curves. These were used on the Bay Bridge reconstruction project.

- First production and installation of prestressed lightweight concrete piles for the very long and large size piles.

- Prestressed concrete snowsheds for railroads.

- Integrally-colored prestressed concrete bridge girders; prestressed concrete sheet piles.

- Entirely precast pretensioned marine structures such as wharves, graving docks, and piers consisting of precast piles, pile caps, decks and fender piles (Figs. 54 and 55).

All this was the foundation for still greater things. Ben Gerwick, now professor at the University of California, concerns himself with large prestressed concrete marine structures such as the offshore platforms in the North Sea, the offshore terminals in Australia, and floating facilities such as LPG and LNG barges. With regulatory agency approval, Arthur Anderson developed these conceptual designs and built the barges.⁵⁰

The Gerwick firm, presently owned by Santa-Fe Pomeroy, is manufacturing prestressed concrete ties, bridge girders and piles for worldwide use. T. Y. Lin and his organization have continued designing some of the outstanding bridges and buildings in the world. Basalt Rock Co. (now a subsidiary of Dillingham) is producing precast and prestressed concrete building elements, especially architectural elements.

Prior to and subsequently, simultaneously with Ben Gerwick's efforts, the use of pretensioned concrete piles was also being developed in Florida, but the main driving forces on the West Coast were Anderson, Gerwick, Lin, Kulka, and Streblov—who were and still are an inspiration to many.

Closing Thoughts

"... Ahead of anything else comes the quality of the product." *Charles Luckman, AIA Keynote Address, PCI Annual Convention (1958)*

What have we learned from this series of articles reflecting upon the beginnings of prestressed concrete in America?

First, the notion of "prestressing" concrete was "magnetic." Hundreds were attracted to conferences, short courses, symposia and conventions because many felt hamstrung by the limitations of the materials which existed in their time. Here was a unique method of combining steel and concrete, which would allow spans to be extended where they could not have been extended before, where shallower construction depths were possible for a given load, and where heavier loads could be carried than would otherwise have been possible.⁶¹ Above all, it gave engineers the power and freedom to control the internal "stresses and strains" produced by the application of exterior design loads. Ingenious design and construction solutions to structural problems seemed limitless. These were the challenges and the attractions of prestressed concrete in its early days.

Second, as we might have suspected, we all learned that introducing a truly new structural concept was not to be a "bed of roses." The price in heartache and frustration for the privilege of having new freedom of design and construction was often very high indeed. The events described in this series suggest that he who leaves a beaten path will feel exhilaration, but also the pain of frustration.

During those early years of the prestressing industry we had already begun to feel the stifling presence of government by regulation rather than by legislation (see Fig. 56). In retrospect, it seems almost inconceivable for an "approving agency"—whichever one this might have been—to have questioned

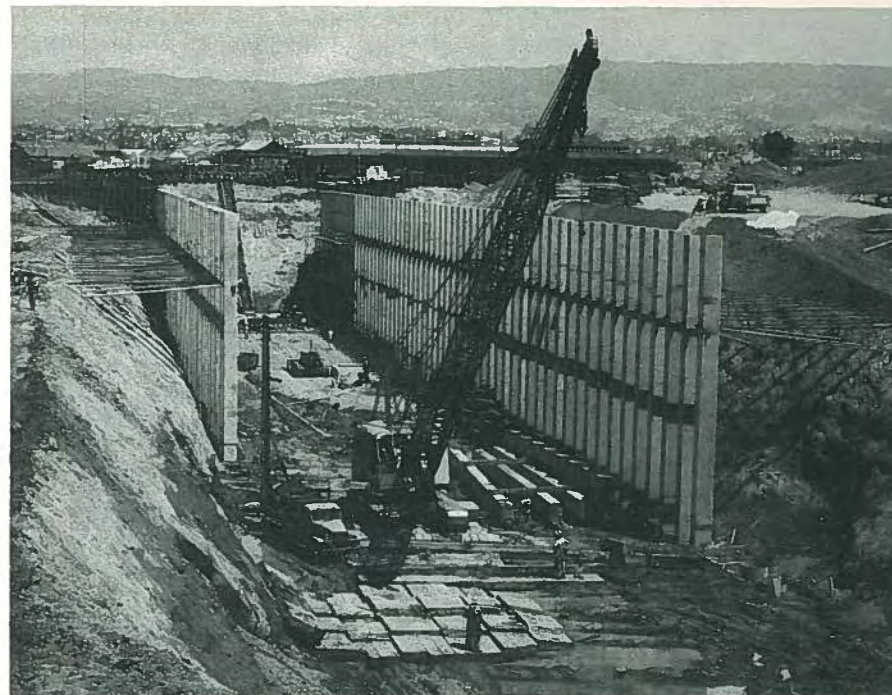

Fig. 54. Contractor's graving dock for manufacture of sub-aqueous vehicular tubes at Webster Street Tube, Oakland-Alameda, California, 1960. Prestensioned concrete soldier beams are designed for maximum negative moments through the addition of mild steel.

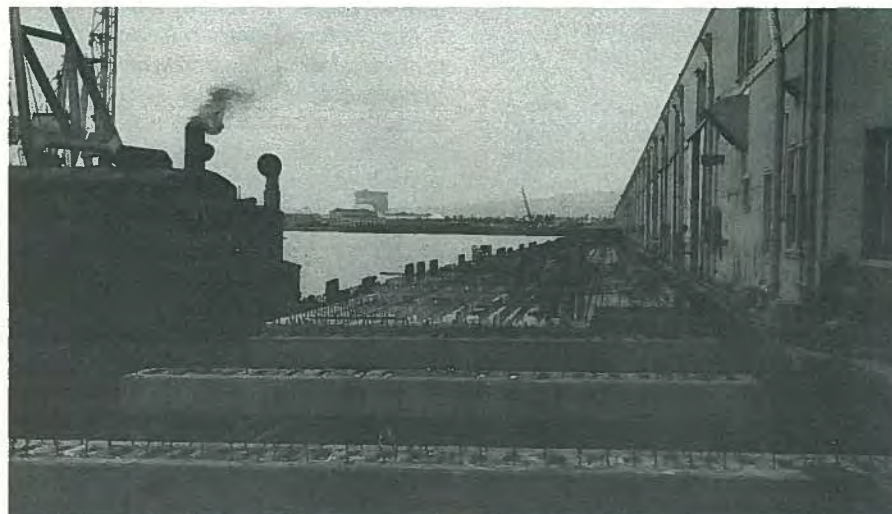

Fig. 55. All prestressed marginal wharf for railroad loading: prestensioned concrete piles, precast pretensioned cap girder, and precast pretensioned deck slabs to be part of lower portion of deck make up the structure. Cast-in-place concrete in upper part of deck ties together all the components of the wharf.

We have become a government not of laws passed by elected officials and representatives—but a government of regulation passed, in the most part, by people who are not elected. Why? Probably because of necessity in the beginning, because it became clear that the elected Congress could not deal with every aspect of our society, of our economy, of our technology, and we needed the expertise of the agencies—both in the Executive Branch and in the independent agencies.

But during the last fifty years, this process has grown into what I believe is a Frankenstein's monster: government by bureaucracy has overwhelmed government by the people and their elected officials. A Congress of the United States will enact five hundred laws during its tenure. During that same time, the bureaucracies will issue ten thousand rules and regulations, which have the same force and effect of law as an act passed by the Congress. These regulations are frequently issued by people who are not familiar with the problem, the concerns or the solutions, as many other people in our society. And there has grown to be a lack of accountability.

Fig. 56. Edited excerpt from Representative Elliott H. Levitas' speech at ASCE's Atlanta meeting (October, 1979). Representative Levitas is the sponsor of HR 1776, a bill that would authorize Congressional veto of agency-formulated regulations. From Civil Engineering, ASCE, V. 50, No. 3, March, 1980, p. 98.

technical abilities, judgment or common sense of engineers such as Bill Dean, for example. Bill Dean's reputation as a prudent and thoughtful (though outspoken) engineer had been proven time and again. For years he had consistently produced concepts and designs for, and supervised the construction of, multi-million dollar bridge structures of all types and sizes and in widespread locations; yet he was repeatedly required to prove through costly tests of full-sized components that what he advocated was

sound, because those holding the purse strings had the power to give or withhold approvals, and thereby the funding, for badly needed projects.

Little did we realize at the time that this was to be the beginning of encroachment on the freedom of professional engineers to express their design concepts as they saw fit. It has developed to such a state that today the engineer is bound not only by reasonable bodies of law such as building codes and fire resistance requirements, but also by restrictive environmental protection regulations, energy regulations, OSHA safety requirements, and so forth. In addition, an engineer must secure approvals for his proposed designs from a myriad of simply "interested" agencies, regardless of whether or not these agencies have bothered to become fully acquainted with the intricacies of the specific conditions and restraints governing a particular design.

The latest threat was the attempt by the Federal Trade Commission (FTC) to regulate all organizations concerned with writing Standards, Codes and Specifications. The FTC seems conveniently to forget that an excess of rules and regulations are the bane of our modern society because such excesses erode incentive. One has only to look at numerous not-so-free societies where central powers—that be dictate by rule and regulation what should be constructed, where and how it should be constructed, without any real regard for costs or relevancy. The result is always indifference, stagnation, lack of progress (or limited progress at best) and, as is very apparent, very poor quality work. (There are already alarming statistics to show that in recent years productivity in America has been declining.) Why? Because over-regulation kills human incentive. We simply cannot afford to let this sort of situation entrap us.

The serious potential impact on our own industry of the FTC's proposed new

rules and regulations, as described in the July 1979 issue of ACI's *Concrete International*, is even more obvious when we remind ourselves that the current ACI Code for prestressed concrete has not changed substantially from what it was in 1960, 20 years ago! The time has now come to revise it, and I am certain that the industry will be unwilling to let the FTC tell it how to do this, and by whom and where this work will be done.

A facetious statement recently made to me by a state engineer: "We no longer build bridges in concrete or steel—we build them in paper," vividly characterizes the mountain of paperwork now required to bring a conventional project (let alone a non-conventional one) from conception to completion by way of an endless string of government approvals. Except in rare instances, the constraints within which the engineer is compelled to work today would most certainly preclude the design innovations and design alternatives contributed by independent consulting engineers in the early days of the prestressing industry in this country.

And where has all this left the producer? He has had his problems too. It is clear that even though the producer is at the core of the prestressing industry and makes the dreams shown on the engineering drawings come true, he is simultaneously the industry's underdog, too often the loser in any struggle concerning his production. If the project engineer is down-to-earth and understands plant production capabilities as well as limitations, and has designed his structural components accordingly, the producer will come out all right.

But if the engineer is simply a desk-bound theoretician rather than a person of practical knowledge of the field, then the producer can find himself in grave difficulties. Thus, we see clearly that it was the joint efforts of producers and engineers who understood each other's problems, and their free association with

material suppliers (such as strand and steel form manufacturers) which were major factors in the rapid development of pretensioned products and the acceptance of those products by the American consumer.

The Raison d'Etre of the PCI

It is natural that, toward the latter part of the industry's beginning period, the recognition of the necessity for this extraordinary and unusual cooperation between three distinctly different groups—engineers, plant producers and material suppliers—was to become the basis for the organization of the Prestressed Concrete Institute. To this day, the Institute derives its strength from their joint efforts.

With respect to the subject of "joint effort," I might take the liberty here to mention that Belgium, which was instrumental in bringing prestressed concrete to America (see Part 1), has on its coat of arms the inscription "L'Union Fait la Force"—Strength through Unity. From time to time, particularly in stressful times, Belgians are reminded that "Flemish or Walloon is your given name, Belgian is your family name." Paraphrasing, I believe it to be apropos to say that "Pretensioning or Post-tensioning" is our given name—and "Prestressing" is our family name.

Fragmentation is weakness *per se*. Would we not indeed be stronger if we could speak with a single voice and present a strong unified front in Washington at times when we must present the "prestressing" case? And would not a united industry increase the prestige and authority of our *entire* prestressed concrete construction industry?

And now, where do we go from here?

Despite all our growing pains, the soundness of the prestressing concept has prevailed and our industry has come a long way. Our opportunities will continue to be limitless provided the producers continue to heed the suggestions and recommendations of the engineers,

and if in turn, the engineers continue to make the effort to understand the producers' abilities and limitations.

Above all, however, the industry must have, first, foremost and always, a good, uniform recognized product. If any of our products is not durable, is not uniform or leaves anything to be desired, or if the assembly of the elements into the structure is unsatisfactory due to improper erection procedures, then an unfavorable impression of the entire industry will result. This situation will naturally discourage future use of prestressed concrete products. That would signal the end of the line for all of us.

On the other hand, acceptance by the client of the product on its own merits will spark the incentive necessary for the industry to recapture the spirit of the early days. In turn will come the search for new applications and uses based on the prestressing concept, the search for ways and means to modify and improve existing products such as the PCI-AASHTO bridge beams and building components, and the examination and updating of codes relating to prestressed concrete. As a matter of record, the prestressed concrete railroad tie industry

and the burgeoning segmental bridge construction industry are already pointing the way.

We must never forget that to survive, an industry must not only have a well-directed research and development program but also suitable markets for its products.

But each key component of the industry—engineer, producer, material supplier, researcher—must do his part. Progress does not just happen—people make it happen. The Institute can and will lead the way for what I am sure will be a bright future. All that is needed is those same ingredients of 25 years ago:

- Enthusiastic and inspiring engineers;
- Resourceful, dynamic and strong willed producers;
- An able, vigorous, sound, and well-organized Institute.

We are now at the beginning of another promising era. Let us make sure that 25 years from now, someone can write for this JOURNAL a history of the new era with the same enthusiasm with which this series was written.

* * *

EPILOGUE

This series of articles told the entire story of the early days of practical American linear prestressed concrete—well, almost. There still remains the story of the long, arduous and unselfish labors of those who were concerned with code writing and specifications.

There also remains to be told in some detail the invaluable contributions made to the industry by University Research Laboratories and the Portland Cement Association's Research Laboratories at Skokie, Illinois. Perhaps some day these stories will also be written.

ACKNOWLEDGMENTS

In 1974, a substantial portion of my archives were inadvertently destroyed. I was heartbroken. I would have felt worse had I then known that sometime in the future I would have need for some of that material for this concluding paper! When the time did come a few months ago, I was fortunate enough to receive assistance from many people who were willing to loan me the cherished material they had saved for so many years with great care. I thus was able to supplement my own resources.

On behalf of PCI and the readership I wish to express my deepest appreciation to all who have made their material, especially the illustrations, available to me. In particular, I am grateful to Robert N. Bruce, Jr., professor at Tulane University and Warren H. Moses, vice-president and general manager of Bayshore Concrete Products, for material and photographs related to cylindrical piles; to H. Kent Preston, who not only loaned me unique material but also checked for accuracy the portion of the manuscript pertaining to Roebing; to Blair Birdsall, partner of Steinman, Boynton, Gronquist & Birdsall for inside information and historic data on the Roebings; to Hank Godfrey for the photograph of John A. Roebing; to Eric Erickson, who in a lengthy letter recounted some of the events from his viewpoint; to Ray Gross from the

Formigli Corporation for catalogues on Channelcrete panels and photographs of the New Jersey bridges; to Walter Podolny of the Federal Highway Administration who had to hunt through Federal archives for a set of drawings on the old Bureau of Public Roads' beam standards; to Burr Bennett for loaning me his only remaining copy of his November 21, 1955, fire test data; to Armand "Gus" Gustafiero, who in addition to lending me material and photographs related to fire, checked for accuracy the portion of the manuscript pertaining thereto; to Gerd Marohn for illustrations of the North Carolina Schools; and finally to Ben C. Gerwick, Jr., upon whose letter I based much of the manuscript relating to events on the West Coast (and who had such a hard time finding Fig. 47 which I so desperately wanted to include in the paper).

For the better part of 2½ years my participation in this series has been indeed a labor of love, with the midnight oil burning more often than not. However, without the inspiration, advice and encouragement which I received from the JOURNAL'S Editor-in-Chief, George D. Nasser, and that of his assistant, Susan Price, who assisted in the review and editing process, I am not so sure that I could have made the effort which was required. To all, my heartfelt thanks.

* * *

NOTE

A summary of milestone events and developments in the North American prestressed concrete industry between 1939 and 1958 follows the references. This chronological list includes brief comments and references to articles in the technical literature, including previous parts of this series, where appropriate.

REFERENCES

37. "How Prestressed Concrete Fared in a Fire," *Engineering News-Record*, October 28, 1954.
38. Ashton, L. A., and Bate, S. C. C., "Fire Resistance of Prestressed Concrete Beams," *ACI Journal*, May 1961.
39. Carlson, C. C., and Tatman, Phil J., "The New Beam Furnace at PCA and Some Experience Gained from its Use," ASTM-STP 301, Symposium on Fire Test Methods. "Function of New PCA Research Laboratory," PCA Research Department Bulletin 109. "PCA Fire Test Center Works on Problems Relating to Prestressed Concrete." Remarks by Dr. A. Allan Bates, Vice President for Research and Development, PCA. *PCI JOURNAL*, V. 3, No. 4, March 1959.
40. Gustafarro, A. H., and Carlson, C. C., "An Interpretation of Results of Fire Tests of Prestressed Concrete Building Components," *PCI JOURNAL*, V. 7, No. 5, October 1962.
41. Gustafarro, A. H., "Fire Resistance of Post-Tensioned Structures," *PCI JOURNAL*, V. 18, No. 2, March-April 1973.
42. Spronck, M. A., "How America is Using Prestressed Concrete, First U.S. Conference on New Materials Reveals its Use for Pipes, Bridges, Pavement, Piles and Other Structures," *Contractors and Engineers Monthly*, October 1951.
43. "Proceedings of First U.S. Conference on Prestressed Concrete at M.I.T.," Cambridge, Mass., 1951.
44. Spronck, M. A., "Prestressed Concrete: Its Future in the U.S.," *Contractors and Engineers Monthly*, August 1951.
45. Shea, W. D., "Prestressed Roof Girders Set Span Record," *Engineering News-Record*, January 21, 1954.
46. "Prestressed Stringers Mass Produced," *Engineering News-Record*, August 14, 1952.
47. "Which Prestressing Method Has the Lowest Cost?" *Engineering News-Record*, July 3, 1952.
48. Elliott, A. L., "A Look at Prestressed Concrete Thus Far in California," *PCI JOURNAL*, V. 1, No. 3, December 1956.
49. "Prestressed Concrete in Russia," *PCI JOURNAL*, V. 3, No. 3, December 1958, pp. 24-39.
50. Anderson, A. R., "World's Largest Prestressed LPG Floating Vessel," *PCI JOURNAL*, V. 2, No. 1, January-February 1977.
51. *Engineering News-Record*, January 18, 1951, p. 39.
52. "Construction Starts on Prestressed Concrete Bridge in Philadelphia," *Civil Engineering*, July 1949.
53. Magnel, Gustave, *Prestressed Concrete* 2nd Edition, p. 154 to p. 165 "Test of a Prestressed Concrete Beam of 155 ft. Span."
54. Bowman, Waldo, "Full-Size Prestressed Girder Tested," *Engineering News-Record*, November 3, 1949.
55. "Testing Long Prestressed Concrete Girder," *Concrete*, December 1949.
56. Ekberg, Jr., C. E., "The Characteristics of Prestressed Concrete Under Repetitive Loading," *PCI JOURNAL*, V. 1, No. 3, December 1956.
57. Kluge, R. W., "Prestressed Concrete Research at the University of Florida," *PCI JOURNAL*, V. 1, No. 2, September 1956.
58. "Behavior of Simple and Continuous Composite Prestressed Concrete Beams, Part I and II," *PCI JOURNAL*, V. 2, No. 1, June 1957.
59. Zwoyer, E. M., and Siess, C. P., "Ultimate Strength in Shear of Simply-Supported Prestressed Concrete Beams Without Web Reinforcement," *Civil Engineering Studies Structural Reports Series No. 85*, University of Illinois.
60. *World Conference on Prestressed Concrete*, Proceedings, July 1957, Published by World Conference on Prestressed Concrete, Inc.
61. Lin, T. Y., "Big Loads—No Steel—Result in World's Heaviest Prestressed Building Girders," *Civil Engineering*, November 1952.
62. Lin, T. Y., and Itaya, R., "Tests of a Prestressed Concrete Hyperbolic Paraboloid Shell," *PCI JOURNAL*, V. 3, No. 1, 1958, pp. 70-78.

* * *



Milestones of Events and Developments in North American Prestressed Concrete Industry

MILESTONES OF EVENTS AND DEVELOPMENTS IN NORTH AMERICAN PRESTRESSED CONCRETE INDUSTRY (1939-1958)

Summarized below is a chronological listing of events influencing the development of the practical use of linear prestressed concrete in the United States and other parts of the western hemisphere. Where appropriate, brief comments are included and references to articles in the technical literature are given where additional details can be found. Reference numbers refer to references for Part 9 of this series only.

YEAR	EVENTS AND DEVELOPMENTS
1936	First experimental prestressed concrete piles driven by the Raymond Concrete Pile Corporation in New York Harbor. ¹
1944	Roebing engineers begin study of prestressing steel and research in prestressed concrete. ⁷
1946	Prestressed concrete floor slab designed by Roebing is completed in Roebing's Chicago warehouse. First prestressed concrete structure in the United States and first use of Roebing materials specifically developed for prestressed concrete such as factory-made prestressed cable assemblies consisting of cold-drawn hot-galvanized acid steel wire, and specially designed end terminals. ⁸
1946	Tests of three sets of four prestressed concrete beams begin at Tulane University under the direction of Professor Walter Blessey. ¹
1947	A. Lumberville suspension bridge completed. Floor was prestressed by means of Roebing's 1/2 in. (12.7 mm) diameter high strength rods having threads at their ends for prestressing and anchoring. ⁷
1947	B. Professor Magnel's first visit to the United States (sponsored by the Belgian American Educational Foundation), see Part 1.
1949	A. Rio Paz suspension bridge, connecting Guatemala to El Salvador, opened to highway traffic. It features precast prestressed concrete floor slabs similar to the Lumberville bridge. ⁷
1949	B. Start of the fire tests on prestressed concrete elements at Korchamwood, Great Britain by the British Joint Fire Research Organization. ³⁸
Spring 1949	C. Start of construction of the substructure for the Walnut Lane Bridge and of the manufacture at the site of the full-sized 160 ft (48.8 m) long test girder. First use of stress-relieved wire, an American innovation (Roebing). See Parts 1 and 2 of this series and Reference 52.
Fall 1949	D. Start of test to failure of full-sized Walnut Lane test girder (October 25, 1949). Beginning of site casting of actual girders. See Part 1 of these series and References 53, 54, and 55.
1949	E. Concrete Products Company of America starts production of box girders in America's first pretensioning plant, at Pottstown, Pennsylvania. See Part 2 of these series.
1950	Fayetteville, Tennessee Stadium. Use of Roebing galvanized prestressed concrete strands and anchor fittings. ⁵¹
October 1950	Turkey Creek Bridge, Tennessee. Completion of first American prestressed concrete bridge using concrete blocks and Roebing developed prestressing materials. ⁵¹
1951	Fritz Research Laboratory at Lehigh University, Bethlehem, Pennsylvania, begins tests on box girders. Sponsored jointly by the department of Highways of Pennsylvania and Roebing, the program was to last more than 20 years, continuously.
1951	Formation of Precompressed Concrete Company Ltd. (PRECO), first Canadian firm entering the prestressed concrete field.
July 1951	Illinois Cooperative Highway Research program was conducted at the University of Illinois, under the direction of Professor Chester Siess. Question and answer session at the AASHTO Committee meetings on Bridges and Structures and Bureau of Public Roads. It marks the beginning of University of Illinois' research in prestressed concrete.
August 1951	First United States National MIT sponsored prestressed concrete conference. ⁴³
December 1951	First American <i>pretensioned</i> prestressed concrete bridge using non-stress-relieved <i>strands</i> as manufactured by American Steel and Wire Corporation completed in Hershey, Pennsylvania. Reference: Part 2 and Part 7 of these series.
1951	Completion of first California prestressed concrete foot bridge using headed wire. Reference: Part 5 of this series.
1952	A. Completion in Middle West of first buildings using prestressed girders and permanent slabs stressed by headed wires. See Part 5 of this series.
1952	Professor Mark W. Huggins at Toronto University participates in design of prestressed concrete roof joists for Hydro Electric Power Commission of Toronto (Reference: Part 8).
1952	B. North Vancouver, Canada. Construction begins on first prestressed concrete bridge in Canada using Magnel-Blaton anchorages. See Part 8 of this series.
1952	C. Casting yards for pretensioned prestressed concrete begin to be established in Florida, Colorado, and Washington. Once these plants were in operation the economy of pretensioned prestressed concrete soon became apparent and the construction of new plants began to spread rapidly and to mushroom throughout the United States (Parts 3, 6, and 7).
1952	D. Construction of the approx. 15,000 ft (4750 m) long Tampa Bay Trestle using Stressteel bars, at the time the longest prestressed concrete trestle. See Part 2 of this series.
1952	E. Bureau of Public Roads (now Federal Highway Administration) publishes its short "criteria" to be used in the design of post-

- tensioned prestressed concrete bridges.
- 1952 F. The Fritz Research Laboratories at Lehigh University published their *first* Progress Report in the program of prestressed concrete research begun in 1951. It was to give the impetus for the construction of the prestressed concrete box girders. This program, which operated continuously since 1951 with a budget of about \$40,000.00 per year, then a substantial amount, helped establish a thorough understanding of the structural properties and short and long-time behavior of prestressed concrete box-girders. It should be mentioned that the John A. Roebing Company provided part of Lehigh's budget and H. Kent Preston's free engineering services for those 20 years. Professor William J. Eney, Director of Fritz Engineering Laboratory and Head, Department of Civil Engineering and Mechanics and Professor Carl E. Ekberg Jr., at the time Associate Professor of Civil Engineering at Lehigh University were in full charge of the program. Numerous reports of their research findings were published. Reference 56 is one of them.
- 1953 September 10, formation of Prestressed Concrete Development Group of Canada (Reference: Part 8).
- 1953 Prestressed concrete research programs began on a large scale on a systematic basis at a number of leading American Universities in addition to Lehigh University.
- 1953 A. *University of Florida, Gainesville, Florida*—In cooperation with the Florida State Roads Department: A study concerning plastic flow and shrinkage of prestressed concrete. Fourteen such prestressed concrete girders cast at various Florida bridge construction sites were held under observation for several years. Professor Ralph W. Kluge, Head Professor of the department of Civil Engineering, Professor Alan M. Ozell, Professor of Civil Engineering and Paul Zung-Teh Zia, Assistant Professor were for many years concerned with research on prestressed concrete. A wide variety of programs were sponsored and financed by Florida's State Department of Roads and directed by William E. Dean. See References 57 and 58 and Part 9 of these series, March-April issue.
- 1953 B. *University of Illinois, Urbana, Illinois, with the Illinois Division of Highways and the U.S. Bureau of Public Roads*—As Research Associate Professor of Civil Engineering Professor Chester Siess was extremely interested in shear strength of prestressed concrete beams. Consequently, a most elaborate program was established. Much of the work was the responsibility of Eugene Zwoyer, then Research Associate in Civil Engineering, presently Executive Director of the American Society of Civil Engineers. As part of the initial investigation of the long range study, tests were made on 34 simply supported prestressed concrete beams without reinforcement. (Beams were 6 in. (152 mm) wide, 12 in. (305 mm) over-all depth and 10 ft (3.05 m) long.) This project, and several subsequent projects, served as the basis for the recommendations for shear design which eventually became part of ACI's Building Code 318.⁵⁹
- 1953 C. *University of California*—Beginning with the on site testing of the Arroyo Seco Pedestrian Bridge in 1951, continuing throughout 1952, laboratory tests on prestressed concrete under the stimulus of Professor T. Y. Lin were in full swing by 1953. At that time emphasis was on prestressed concrete thin shells and flat plates. Findings were to be at the basis for the subsequent design and construction of the cantilever thin shell roof for the Caracas Stadium for which Felix Kulka, presently President of T. Y. Lin International, was responsible.⁶²
- 1953 D. *Portland Cement Association Research and Development Laboratories, Skokie, Illinois*—At PCA's laboratories consideration was being given to commence large research programs to include full size girders, all under the leadership of Dr. Alan Bates, Dr. Eivind Hognestad and Dr. Alan H. Mattock, who was at the time Principal Development Engineer at the Structural Development Section. Reports of many tests were published by PCA.
- 1954 A. January 28, 29, 1954 Canadian Conference on Prestressed Concrete at University of Toronto. Professor Magnel attended as did many Canadian and American engineers. Very lively discussions. Particularly valuable were the tests on full-sized beams reported by Cleveland's Austin Company.
- 1954 Use for the first time in Canada of 5000 psi ready-mixed concrete (Reference: Part 8).
- 1954 B. Publication by the Bureau of Public Roads of the revised and expanded "Criteria For Prestressed Concrete Bridges" for both pretensioned and post-tensioned concrete.³⁰
- 1954 C. Founding of Prestressed Concrete Institute. See Part 3.
- 1954 D. Prestressed Concrete Institute published the first edition of the Tentative Specifications for *Pretensioned* prestressed concrete.
- 1955 Bureau of Public Roads, Highway Research Board and others complete arrangements for construction of \$12-million (increased before completion of Project to \$27-million) road test project of AASHO, in Ottawa, Illinois. Project included prestressed concrete bridges. In 1962 AASHO revealed results in an extensive three-volume report. At least three sets of data influenced subsequent prestressed concrete bridge design in that tensile stresses would be allowed in concrete prestressed with strands. (Up to then no bottom tensile stresses were allowed at midspan of girders.)
- 1957 First World Conference of Prestressed Concrete at San Francisco sponsored by PCI with the cooperation of National Professional Societies.⁶⁰
- 1958 Publication by ACI-ASCE Joint Committee 323 of the Tentative Recommendations for Prestressed Concrete.

For the purpose of this Series, this publication of 1958 marks the practical end of the "Beginnings" of prestressed concrete.

Walnut Lane Bridge Named "Outstanding Achievement"

The Philadelphia Section of the American Society of Civil Engineers (ASCE) honored the first prestressed concrete bridge built in North America by including Walnut Lane Bridge as an ASCE "Outstanding Civil Engineering Achievement."

Ceremonies were held on May 5th at the site of the bridge. Those responsible for the design and construction of Walnut Lane Bridge (considered a daring venture in the late 1940s) included longtime PCI Member **Charles C. Zollman**, then-engineer for the Preload Corporation—fabricators of the bridge's components, **Samuel S. Baxter**, then-chief engineer for Philadelphia's Bureau of Engineering, Surveys and Zoning, and **Max Barossky**, then-assistant to Baxter, in charge of field construction.

In his address at the re-dedication, Samuel Baxter mentioned that 27 years ago this bridge and the concept of prestressing was considered futuristic. "I wonder what the next 25 years will hold for prestressed concrete; what other applications will come from this amazing concept."

The bridge was completed in 1950. It is located in a natural setting of Philadelphia's Fairmount Park, the nation's largest park to be contained within city limits. The original intention of the Art Jury for Philadelphia was to construct an arch bridge with stone facing. This proved prohibitively expensive. A feasible alternative, one that stayed within budget and still provided an esthetically and structurally sound design, was to build the structure with prestressed concrete.

Professor **Gustave Magnel** of Belgium, a prestressing pioneer, was retained as designer. He directed the Preload Corporation in fabricating the components of this bridge with its daring 160-ft spans.

The ceremonies were also attended by **Brian Lewis**, president of the Philadelphia Section of the ASCE, **Sidney Robins**, Chairman and Editor of the Publications Committee and several distinguished officials of Philadelphia's water, transportation, public works and engineering departments.

The year 2000 marks Walnut Lane Bridge's fiftieth anniversary.



Philadelphia officials attending the ceremonies included (l-r), **Robert Rowland**, district engineer for PennDOT, **Sidney Robins**, chairman of the ASCE historical committee; **Brian Lewis**, president of local ASCE; **Robert McConnell**, director of Fairmount Park; **Samuel Baxter**; **Charles Zollman**; and **James McPhillips**, chief engineer and surveyor, Dept. of Streets.

NOTES

NOTES

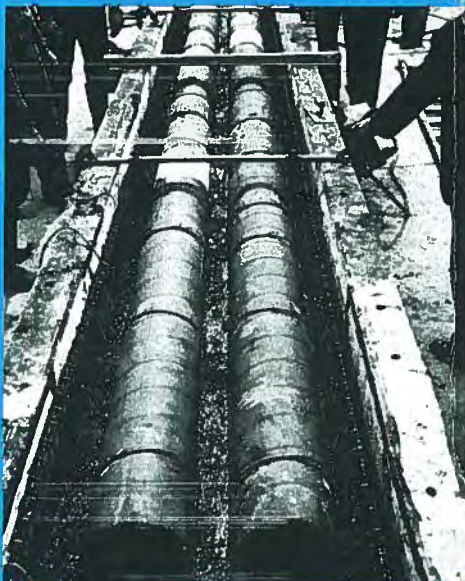

ARCHITECTURAL
PCI
STRUCTURAL

JRH-81

PRESTRESSED CONCRETE INSTITUTE
201 N. WELLS STREET
CHICAGO, ILLINOIS 60606

