



Total Thermal Management of Battery Electric Vehicles (BEVs)

Sourav Chowdhury, Lindsey Leitzel, Mark Zima, and Mark Santacesaria Mahle Behr Troy Inc.

Gene Titov, Jason Lustbader, John Rugh, and Jon Winkler National Renewable Energy Laboratory

Aamir Khawaja and Murali Govindarajalu FCA US LLC

Citation: Chowdhury, S., Leitzel, L., Zima, M., Santacesaria, M. et al., "Total Thermal Management of Battery Electric Vehicles (BEVs)," SAE Technical Paper 2018-37-0026, 2018, doi:10.4271/2018-37-0026.

Abstract

The key hurdles to achieving wide consumer acceptance of battery electric vehicles (BEVs) are weather-dependent drive range, higher cost, and limited battery life. These translate into a strong need to reduce a significant energy drain and resulting drive range loss due to auxiliary electrical loads the predominant of which is the cabin thermal management load. Studies have shown that thermal subsystem loads can reduce the drive range by as much as 45% under ambient temperatures below -10°C . Often, cabin heating relies purely on positive temperature coefficient (PTC) resistive heating, contributing to a significant range loss. Reducing this range loss may improve consumer acceptance of BEVs. The authors present a unified thermal management system (UTEMPRA) that satisfies diverse thermal and design needs of the auxiliary loads in BEVs. Demonstrated on a 2015 Fiat 500e BEV, this system integrates a semi-hermetic

refrigeration loop with a coolant network and serves three functions: (1) heating and/or cooling vehicle traction components (battery, power electronics, and motor) (2) heating and cooling of the cabin, and (3) waste energy harvesting and re-use. The modes of operation allow a heat pump and air conditioning system to function without reversing the refrigeration cycle to improve thermal efficiency. The refrigeration loop consists of an electric compressor, a thermal expansion valve, a coolant-cooled condenser, and a chiller, the latter two exchanging heat with hot and cold coolant streams that may be directed to various components of the thermal system. The coolant-based heat distribution is adaptable and saves significant amounts of refrigerant per vehicle. Also, a coolant-based system reduces refrigerant emissions by requiring fewer refrigerant pipe joints. The authors present bench-level test data and simulation analysis and describe a preliminary control scheme for this system.

Introduction

In recent years, the global automotive industry has focused on developing efficient, affordable, long range, battery-powered passenger vehicles that will compete with and ultimately replace their fossil-fuel-powered counterparts. While battery electric vehicle (BEV) architecture and supporting infrastructure are maturing, hybrid and plug-in hybrid electric vehicles have immediate appeal even though they retain the dependence on fossil fuels. Further adoption of battery-powered vehicles will require lowering the cost of batteries, enabling fast charging, ease of access to charging locations, and reliable longer range. It is also important that range does not significantly vary due to auxiliary loads such as heating and cooling of the cabin and vehicle components, similar to passenger experience with traditional internal combustion engine (ICE)-powered vehicles. In ICE vehicles, the auxiliary loads represent a small fraction of the fuel use since a significant fraction of energy is lost as waste heat. In BEVs, due to a highly efficient conversion ratio (battery energy to traction), waste heat energy is very low and so the

auxiliary loads account for a much larger fraction of energy use; therefore, BEVs require auxiliary systems to be more efficient. Specifically, heating in an ICE vehicle is virtually free due to being able to use waste heat from the engine. In BEVs, heating competes with traction power and can heavily drain the battery in cold weather conditions. A survey of the BEV architectures in recent years indicates that the industry has been experimenting with combinations of different thermal management concepts: pre-conditioning of the cabin; air-, coolant- and refrigerant-cooled batteries; heat pumping; collection and re-use of waste heat; etc. Some of these technologies can be combined to increase efficiency while lowering the cost and complexity of implementation.

This study used a 2015 Fiat 500e BEV (Figure 1). Typical of this generation of BEVs, this vehicle has three thermal loops:

1. Cabin air conditioning loop
2. Battery heating/cooling loop
3. Power Electronics and Electric Motor (PEEM) cooling loop.

FIGURE 1 2015 Fiat 500e BEV with a 24-kWh lithium-ion battery



© SAE International

This vehicle has a standard vapor compression loop for cabin air cooling and providing active cooling to the traction battery via a refrigerant-to-coolant heat exchanger (battery chiller). The vapor compression loop uses R-134a refrigerant and includes an electric compressor, a standard refrigerant-to-air evaporator, and standard thermal expansion valves (TXVs). Heating the cabin air is achieved using a 5-kW positive temperature coefficient (PTC)-based electric air heater located in the heating, ventilating and air conditioning (HVAC) module.

In addition to being actively cooled by a chiller, the battery is also cooled by coolant circulating in a loop between the battery and a dedicated front-end radiator receiving forced ambient air flow. The loop has a 6 kW PTC coolant heater for heating of the battery. Figure 2 shows the schematic of the thermal loops in this vehicle. Testing has confirmed that loss of range of this vehicle is 45% at -10°C compared to range at 22°C .

FIGURE 2 Three thermal sub-systems of Fiat 500e BEV

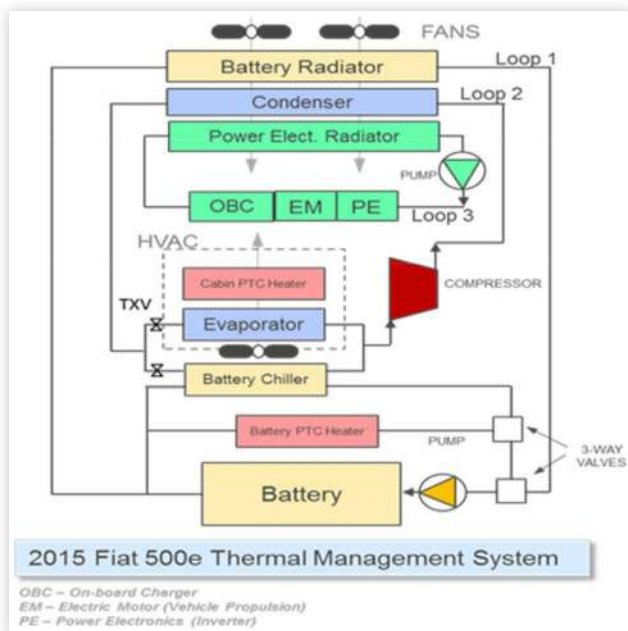

A cursory analysis reveals that while the three sub-systems are somewhat separate and independent in operation, lending themselves to a straightforward method of control, the electric heating of the air for HVAC management represents a significant drain on the battery energy, while the waste heat of the battery and PEEM are not used.

The UTEMPRA System

With its unique flexibility in design and integration of the coolant architecture, the Unitary Thermal Energy Management for Propulsion Range Augmentation (UTEMPRA) system unifies the thermal management systems of BEVs and may be thought of as a natural evolution of the various types of thermal management architectures in the BEVs to date. It comprises a semi-hermetic refrigeration loop [1] and a coolant network for thermal energy distribution and waste energy harvesting. The refrigeration loop, shown in Figure 3, consists of an electric compressor, a TXV, a coolant-cooled condenser, and a chiller. The condenser and the chiller serve the same purpose as the condenser and the evaporator in a traditional refrigeration loop. Instead of exchanging heat with air, these heat exchangers exchange heat with circulating coolant and therefore act as sources of hot and cold coolant streams.

A version of the UTEMPRA coolant network that addresses the same thermal functions present in the Fiat 500e is shown in Figure 4. This design uses two coolant pumps and valve manifolds that help distribute thermal energy to the vehicle HVAC system and other thermal loads such as the battery, PEEM, etc. In the cooling mode, the cold coolant is conveyed from the chiller to the HVAC Cooler for cabin cooling and dehumidification. When needed, in parallel with the cooler, this same coolant stream can be split and partly routed to cool the battery. A front-end heat exchanger (FEX), sitting in the vehicle front typically occupied by a radiator in ICE cars, rejects the heat from the

FIGURE 3 UTEMPRA's compact refrigerant sub-system running between hot and cold coolant streams

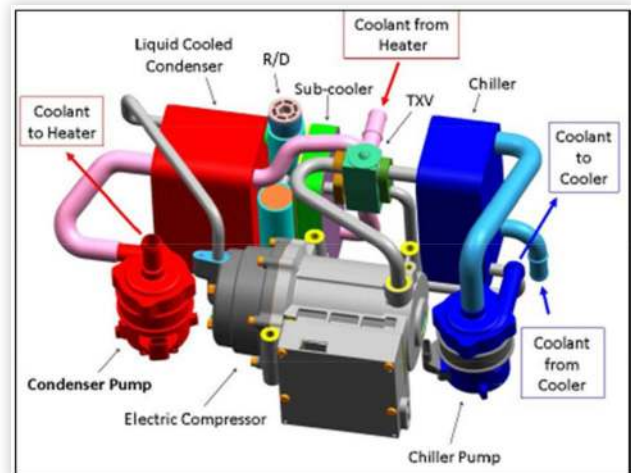
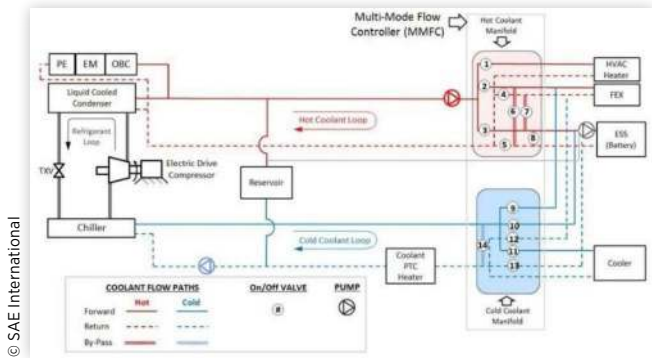

FIGURE 4 Example configuration of the UTEMPRA coolant network addressing the same functions as in the Fiat 500e system



hot coolant coming from the condenser to the air outside. In heating mode, the hot coolant from the condenser is routed to an HVAC heater for cabin heating, while FEX receives coolant colder than ambient air and therefore absorbs heat from it. In parallel with the HVAC heater, this coolant can be routed to the battery to maintain its temperature within the limits. The rapidity of cabin warm-up (HP mode) is tolerably less than that for the baseline vehicle as the latter has HVAC air directly heater where as in this case the intermediate fluid (i.e. coolant) is heated first. This rapidity is similar to that for ICE vehicles in which engine heating takes time also.

Further, since the PEEM produces waste heat and thus always needs cooling, the coolant, in parallel with the condenser, is routed to the PEEM to pick up this heat and then deliver it to the HVAC heater, thereby recycling the waste energy and improving the BEV range. Also, in this mode, the cold coolant stream is routed to the FEX to absorb energy from the ambient air. Therefore, the cooling mode is similar to the standard air conditioning operation while the heating mode operates as a heat pump. The heat exchangers, pumps, the compressor, and TXV are sized to meet the needed thermal capacity requirements of the Fiat 500e components.

The UTEMPRA system replaces the separate condenser, battery radiator, and PEEM radiator of the Fiat 500e with a single heat exchanger, thereby increasing its capacity and effectiveness due to higher availability of ram air pressure. Further, it eliminates the need for separate refrigeration and/or coolant loops for the battery and PEEM cooling. It also eliminates the need for an electric air heater. Together these eliminations and consolidations reduce the total refrigerant charge, pumping power, overall system mass, and cost. In contrast with the baseline vehicle system, one feature of UTEMPRA is that the rapidity of cabin warm-up (HP mode) is less than that for the baseline vehicle as the latter has HVAC air directly heated by PTC air heater where as in this case the intermediate fluid (i.e. coolant) is heated first. This rapidity is tolerable and is similar to that for ICE vehicles in which engine heating takes time also. Added PTC Coolant heater power during the first few mins will reduce the warm-up time without significantly altering the range.

Multi-Mode Flow Controller

The multi-mode flow controller (MMFC) is the novel component that enables a practical implementation of the UTEMPRA system. It is separated into hot and cold halves that direct the respective coolant streams to the different heat sources and sinks. The separate locations of these valve systems will prevent parasitic heat loss or gain. Each half comprises several valves whose bodies are integrated and consolidated to reduce mass and cost while saving precious under-hood packaging space. In the present scenario, coolant flow in the hot coolant loop is directed by a hot MMFC with eight valves which are of on/off type. The eight valves are configured such that coolant can be routed to the HVAC heater, FEX, or the battery separately or jointly. Further, the function of cooling the battery with coolant circulating through the FEX is enabled by a pair of bypass valves. The Fiat 500e BEV also has an option for battery temperature equilibration by flow of coolant out of and immediately into the battery to keep all the cells of the battery within a narrow band of temperature. This function is enabled by another bypass valve in the hot MMFC. Similarly, the cold MMFC comprises six on/off valves and directs cold coolant to the HVAC cooler, the battery, or the FEX, based on the mode of operation. [Figure 5](#) shows a model of the cold MMFC prototype.

In the absence of the MMFC, design, packaging, cost, and installation complexity of such a large number of valves would have made the UTEMPRA system not viable. Hence, this component is a major enabler for this technology.

Location of Coolant PTC Heater

Of the two thermally self-regulating PTC heaters in the Fiat 500e's original system, one was a direct air heater, and the other was a coolant heater. The UTEMPRA system has eliminated the direct air heater but retained the coolant heater. There are two choices of location for the PTC coolant heater: in the hot loop or in the cold loop. Each of these locations has its advantages and disadvantages. The hot loop location enables fast heat discharge to the cabin and the battery since it only needs the coolant in the hot loop to be heated. However,

FIGURE 5 Model of the cold MMFC prototype



this also means that the total available heat is limited to only 6 kW and may compromise the heating capacity compared to the original system. A newer generation of PTC coolant heater can be designed with higher capacity, thereby addressing this issue. The cold loop location, on the other hand, increases the delay in sending heat to the cabin and battery. In addition, the refrigerant loop components will need to be heated. In contrast to the hot loop location, the cold loop location increases the total heating capacity as the power from the compression work is now available as an additional heat source.

Bench Test Rig

A configuration of the UTEMPRA system was built using prototype and production-level components to support a bench test program conducted at the US National Renewable Energy Laboratory. The objective of the test program was to measure the performance of the prototype system and gather information to support system controls development. The test apparatus, described in a previous work [2] and shown in Figure 6, is a hardware-in-the-loop system that imposes thermal loads on the UTEMPRA system and measures the resulting energy consumption and thermal performance. The bench test apparatus consisted of two separate air ducts, a cabin air simulator, and an outdoor air simulator. The bench test apparatus had two electrical resistance coolant heaters, one to simulate the heat from the vehicle PEEM and the other to simulate the heat from the hot-soaked energy storage system (i.e. battery). Key changes to the test apparatus described in [2] include the addition of a humidifier and moving the PEEM heater to the cold loop for heating tests. The UTEMPRA system and test apparatus were controlled using software proportional-integral-derivative controllers as well as simple thermostats programmed into the LabVIEW data acquisition and control program. There were two sets of controls: the test apparatus controls used to stabilize the thermal inputs into the system such as inlet air temperatures, and the UTEMPRA system controls that mimic automatic vehicle climate control. To impose realistic BEV loads on the thermal system, the test bench incorporated a vehicle powertrain model, thermal and efficiency PEEM and energy storage system models, and a thermal cabin model.

FIGURE 6 UTEMPRA bench setup

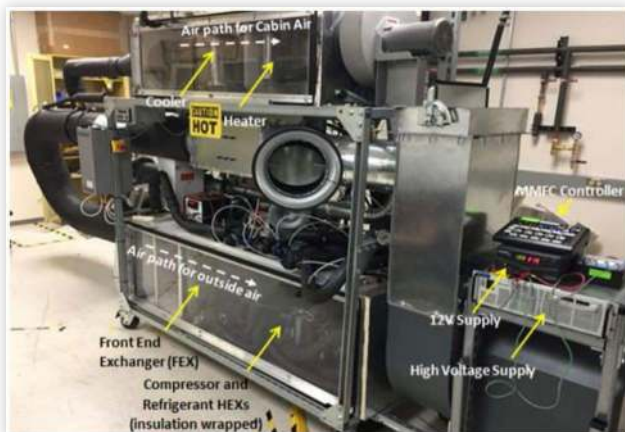

© SAE International

Simulation Model Description

NREL's "Quasi-Transient" CoolSim modeling method was employed for both the refrigerant and coolant circuits for developing the UTEMPRA system model. The details of the solution method are discussed in [3] and details of the coolant loop modeling approach can be found in [4]. Both refrigerant and coolant circuits are represented by 0-dimensional (0-D) volumes connected with 1-D pipes, valves, or orifices. The 1-D lines provide flow rate due to the pressure differential between the inlet and outlet and are used to represent passes in heat exchangers as well as lines connecting components. The 0-D volume blocks represent physical volumes such as heat exchanger headers and also serve the purpose of connecting lines.

The 1-D pipe block assumes a constant coolant mass flow rate along its length. The flow rate then becomes a simulation state variable. At each time step, the coolant pressure differential across each line is compared to the pressure difference between the 0-D volumes that they connect. A numerical method is applied to continuously adjust the coolant or refrigerant mass flow rate in each of the lines. The goal of this method is to match the pressure change in the line to the pressure difference between the volumes that the line connects. Ideally, sub-iterations would be continued until convergence is reached at each time step of the solution to ensure a diminishing difference between the pressure drop in the line and the pressure difference between the connected junctions. This would result in a steady-state solution corresponding to the instantaneous values of boundary conditions at each simulation time step (hence the name "Quasi-Transient"). To speed up the solution, however, only a single iteration is done in each time step. This was found to be an acceptably accurate approach when the computational time-step is relatively small compared to the system-level thermal response characteristic time. In this case, the solution converges fast enough to account for transients.

To further speed up simulations by increasing the solution time step, the notion of artificial bulk modulus was introduced. This allows for changing the relationship between pressure and density and thus the system "stiffness." By setting the artificial bulk modulus smaller than the true bulk modulus of liquids, the numerical stiffness in the coolant and liquid portions of the refrigerant networks can be reduced. This quasi-transient solution method results in lost accuracy for fast transients (on the order of seconds) such as pump cycling. For steady-state conditions, however, the conservation of mass and energy for each volume and each of the 1-D pipes in the model is ensured. The UTEMPRA system, being electrically operated and controlled, does not typically exhibit sharp changes except for closing/opening the valves. Short duration transients resulting from valve operation are of lesser importance from the overall system performance standpoint and are replaced with instantaneous changes. All other transients in the system such as those resulting from the compressor RPM control are adequately represented by the method.

Results

Tests were conducted at two nearly extreme ambient temperatures, hot (43.3 °C) and cold (− 6 °C), to generate system responses that were used as calibration inputs for MATLAB/Simulink models of the UTEMPRA system. The calibrated simulation model was then used to predict the system behavior at various conditions.

Figure 7 indicates the simulation results of a heat pump case at modeled for −10 °C ambient. Figure 7(a) is the case when PTC heat is not provided to supplement the heat from heat pump while Figure 7(b) shows the results with 2-kW steady PTC heat added to supplement the amount of heat pulled by the heat pump from the ambient air. A 0.75-kW heat from the PEEM is assumed in both cases.

The time to reach the cabin target set point temperature of 22 °C is significantly affected by PTC heating. Figure 8(a) shows how the electrical power of the PTC heater affects the time required for the UTEMPRA vehicle to attain the cabin average temperature of 22 °C starting from a soak temperature of −10 °C with the vehicle traveling at 40 km/hr constant speed. If an average of 0.5-kW PTC heat supplements the heat pulled by heat pump, the time to reach the cabin set point will be the same as observed in the original vehicle test with roughly half of the original electric energy consumption. Figure 8(b) shows an initial estimate of range benefit due to the UTEMPRA system: 15.5% at −10 °C assuming a steady speed of 40 km/hr and no pre-conditioning applied to either the original vehicle or the UTEMPRA vehicle.

FIGURE 7 Capacity and temperature response when UTEMPRA system received no PTC heat (a) or 2.0-kW PTC heat at steady rate (b)

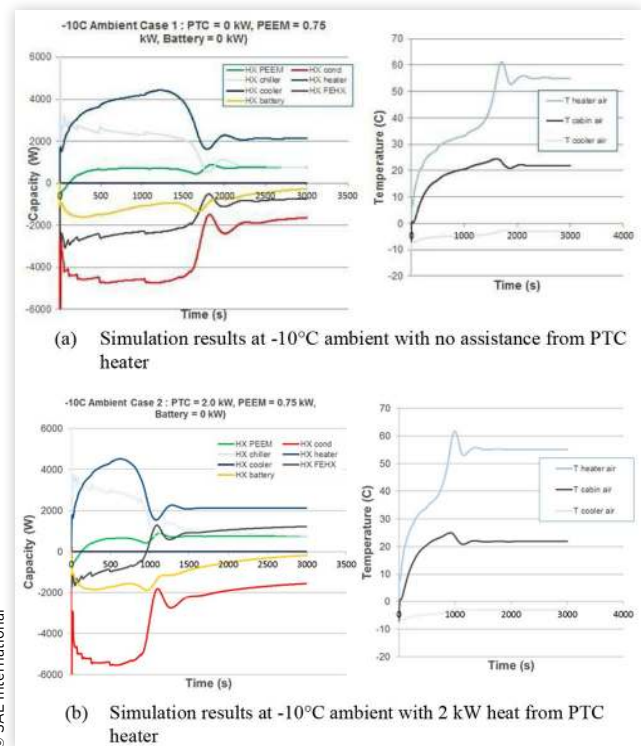
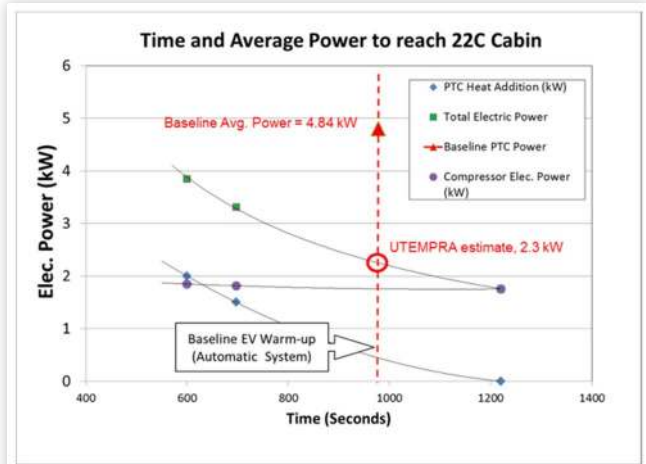
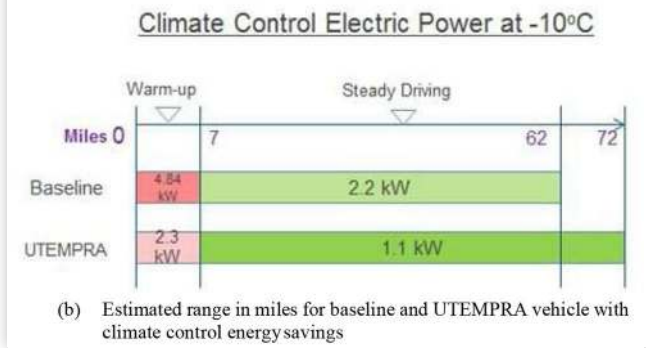

FIGURE 8 Estimates of energy savings and enhanced range with UTEMPRA



(a) Time to reach cabin set-point temperature of 22°C if different PTC heat is applied



(b) Estimated range in miles for baseline and UTEMPRA vehicle with climate control energy savings

© SAE International

BEV Drive Cycle Simulation

SAE J1634 (2012) proposes several methods and drive cycles for testing BEVs for energy consumption and range. One such cycle is the Multi-Cycle Test (MCT), which combines Urban Dynamometer Driving Schedule (UDDS), Highway Fuel Economy Driving Schedule (HFEDS), and constant speed cycle (CSC) segments, and likely represents typical BEV usage, minimizes drive style variation, and increases battery depletion time faster than established certification schedules [5]. Figure 9 shows the combined cycle.

These cycles are proposals that may be varied by an original equipment manufacturer per internal reasoning and knowledge base. The authors adopted a variation of the MCT

FIGURE 9 SAE J1634 (2012) MCT speed profile

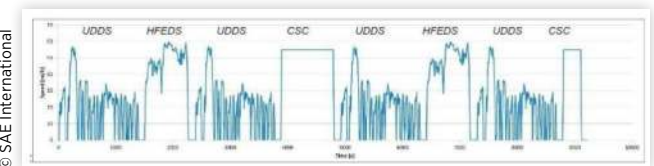

© SAE International

TABLE 1 Prediction of total electrical range using FASTSim model (at -10°C ambient and cabin set point 22°C)

	Electric Consumption (Wh/mile)	Range (mi)	Range (km)
No Auxiliary Heating Load	196.4	108.7	174.9
Fiat 500e Original	292.1	73.1	117.6
Fiat 500e with UTEMPRA	246.0	86.8	139.7

© SAE International

FIGURE 10 Speed profile and total battery power consumptions in Fiat 500e original vehicle and Fiat 500e with UTEMPRA system (-10°C ambient temperature with cabin set point 22°C)

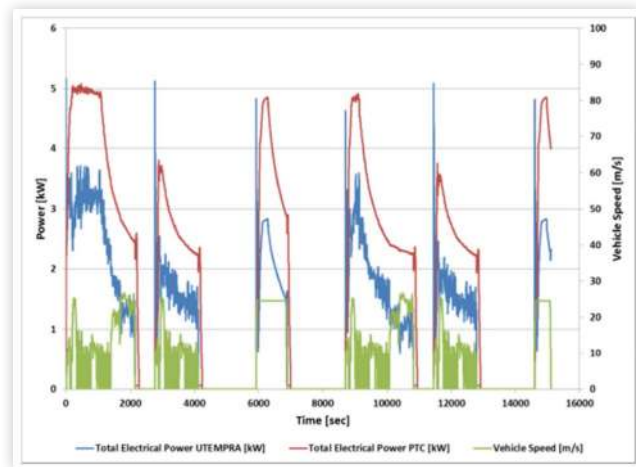

© SAE International

in which the idle and CSC durations are modified, but the fundamental patterns of the UDDS and HFEDS were kept. The National Renewable Energy Laboratory's Future Automotive Systems Technology Simulator (FASTSim) [6] and CoolSim [4] software were used along with vehicle data inputs, UTEMPRA system response, and the MCT variant driving schedule to predict UTEMPRA energy consumption and range improvement. Table 1 and Figure 10 show the modified MCT speed profile used in this study and results for this exercise.

Both steady speed and dynamic drive cycle estimations are indicative of 15%-18% improvement in range using UTEMPRA technology for -10°C ambient.

The main interest in this paper is to mitigate or reduce the impact of severe range loss at cold ambient. Simulations (not presented here) have evaluated the A/C ambients (22°C and above) that show a reduction of range to the tune of 4% at 43.3°C due to loss of efficient from using two-stage heat transfer (first with coolant and then with air) compared to single-stage heat transfer (directly refrigerant to air). The authors are evaluating further ideas to reduce this slight loss of range and explore multiple benefits of coolant heat exchanger and these results will be presented in a future publication.

Summary/Conclusions

1. Trends in the automotive industry indicate that battery-powered vehicles are entering the mass market with one of the significant challenges of range reduction due to auxiliary load, the most important of which is cabin heating and cooling. Vehicle used in this study confirms range loss of 45% at -10°C .
2. In an efficient BEV, waste heat from power electronics, the battery, etc., is important to recover; also, instead of direct resistive heating, it is vital to use heat pump technology to improve the coefficient of performance. The UTEMPRA system delivers both, using a coolant network-based heat delivery system that is easily configurable.
3. The range improvement potential at severe cold ambient conditions is significant with bench-test calibrated models indicating an improvement in the range of 15%-18% is feasible.

References

1. Kowsky, C., Wolfe, E., Leitzel, L., and Oddi, F., "Unitary HPAC System," *SAE Int. J. Passeng. Cars - Mech. Syst.* 5(2):1016-1025, 2012, doi:<https://doi.org/10.4271/2012-01-1050>.
2. Leighton, D., "Combined Fluid Loop Thermal Management for Electric Drive Vehicle Range Improvement," *SAE Int. J. Passeng. Cars - Mech. Syst.* 8(2):711-720, 2015, doi:<https://doi.org/10.4271/2015-01-1709>.
3. Kiss, T. and Lustbader, J., "Comparison of the Accuracy and Speed of Transient Mobile A/C System Simulation Models," *SAE Int. J. Passeng. Cars - Mech. Syst.* 7(2):739-754, 2014, doi:<https://doi.org/10.4271/2014-01-0669>.
4. Titov, G., Lustbader, J., Leighton, D., and Kiss, T., "MATLAB/Simulink Framework for Modeling Complex Coolant Flow Configurations of Advanced Automotive Thermal Management Systems," SAE Technical Paper 2016-01-0230, 2016, doi:[10.4271/2016-01-0230](https://doi.org/10.4271/2016-01-0230).
5. SAE International, "Battery Electric Vehicle Energy Consumption and Range Test Procedure," SAE J1634, Rev. October 2012.
6. Brooker, A., Gonder, J., Wang, L., Wood, E. et al., "FASTSim: A Model to Estimate Vehicle Efficiency, Cost and Performance," SAE Technical Paper 2015-01-0973, 2015, doi:<https://doi.org/10.4271/2015-01-0973>.

Contact Information

Main author - Dr. Sourav Chowdhury, MAHLE
sourav.chowdhury@us.mahle.com

Acknowledgments

The authors would like to thank David Anderson and Lee Slezak of the Department of Energy's Vehicle Technologies Office and Jason (John) Conley of the U.S. Department of Energy's National Energy Technology Laboratory for their

support and guidance throughout this project. This work was supported by the U.S. Department of Energy under Contract No. DE-AC36-08GO28308 with Alliance for Sustainable Energy, LLC, the Manager and Operator of the National Renewable Energy Laboratory. Funding was provided by U.S. Department of Energy Office of Energy Efficiency and Renewable Energy Vehicle Technologies Office. The U.S. Government retains and the publisher, by accepting the article for publication, acknowledges that the U.S. Government retains a nonexclusive, paid-up, irrevocable, worldwide license to publish or reproduce the published form of this work, or allow others to do so, for U.S. Government purposes.

HFEDS - Highway Fuel Economy Driving Schedule
HVAC - heating, ventilating and air conditioning
ICE - internal combustion engine
MCT - Multi-Cycle Test
MMFC - multi-mode flow controller
PTC - positive temperature coefficient
TXV - thermal expansion valve
UDDS - Urban Dynamometer Driving Schedule
UTEMPRA - Unitary Thermal Energy Management for Propulsion Range Augmentation

Definitions/Abbreviations

BEV - battery electric vehicle

CSC - constant speed cycle

FEX - front-end exchanger

This is the work of a Government and is not subject to copyright protection. Foreign copyrights may apply. The Government under which this paper was written assumes no liability or responsibility for the contents of this paper or the use of this paper, nor is it endorsing any manufacturers, products, or services cited herein and any trade name that may appear in the paper has been included only because it is essential to the contents of the paper.

Positions and opinions advanced in this paper are those of the author(s) and not necessarily those of SAE International. The author is solely responsible for the content of the paper.