

Article title:

Towards a BIM-enabled sustainable building design process: roles, responsibilities and requirements

Abstract

Environmental sustainability considerations are often treated as an add-on to building design, following ad hoc processes for their implementation. As a result, the most common problem to achieve a sustainable building outcome is the absence of the right information at the right time to make critical decisions. For design team members to appreciate the requirements of multidisciplinary collaboration, there is a need for transparency and a shared understanding of the process. This research presents the findings from 25 in-depth interviews with industry practitioners concerning 10 case studies of buildings, which achieved high sustainability certification ratings (e.g. BREEAM, Passivhaus, Part L), to identify best practices in sustainable building design (SBD). The results identify the key players' roles and responsibilities, tasks, deliverables and critical decision points for SBD. These components have been coordinated explicitly in a systematic process that utilises Information Communication Technology (ICT), Building Information Modelling (BIM), and Building Performance Analysis (BPA) software to realise the benefits of combining distributed teams' expertise.

Keywords - Design process; Collaboration; Sustainability; Building Information Modelling (BIM); Building Performance Analysis (BPA); Concurrent Engineering (CE); Integrated DEFinition methods (IDEF).

Introduction

Sustainable performance of buildings is currently a major concern among AEC (Architecture, Engineering and Construction) professionals due to measures such as building legislations in addition to national and regional targets (Schlueter and Thesseling, 2009). The overall goal is to reduce the environmental impact of buildings, while enhancing human comfort and health. To address this issue, many countries and international organisations have initiated rating systems (e.g. BREEAM, LEED, Passivhaus) to assess sustainable construction (Azhar et al., 2011; Haapio and Viitaniemi, 2008). Currently, these assessment methods are used as frameworks for environmental design by building professionals, although they provide no guidance over the design process. Also, the design of such high performance buildings is a complex, non-linear, iterative and interactive process that requires effective collaboration between the multidisciplinary

teams from the early stages in order to achieve sustainability outcomes (Bouchlaghem et al., 2005; Yang, Zou, and Keating, 2013).

Building professionals utilise performance analysis tools extensively in order to predict and quantify aspects of sustainability from early design stages and significantly ameliorate both quality and cost during a building's life cycle (Attia, Beltrán, De Herde, and Hensen, 2009; Crawley, Hand, Kummert, and Griffith, 2008; Smith and Tardif, 2012; Tudor, 2013). As a result, building performance assessment workload becomes heavier at the early design stages compared to traditional project delivery. Additionally, timely contributions of design participants and accuracy of the information delivered are important for SBD to be successful (Brahme, Mahdavi, Lam, and Gupta, 2001). For this reason, the most significant challenge to delivering a successful sustainable building is communication and co-ordination across a multidisciplinary team (Robichaud and Anantatmula, 2010). To date, the design process often suffers from lack of collaboration between design teams of different organisations. As a result, the most common problem to achieve a sustainable outcome is the absence of appropriate information to make critical decisions. Therefore, efficient and systematic information exchanges between designers, consultants and sub-contractors become essential to achieve design goals (Pala and Bouchlaghem, 2012). Consequently, software and hardware solutions that support communication become a necessity (Peña-Mora, Hussein, Vadhavkar, and Benjamin, 2000). However, efficient collaboration does not result solely from the implementation of information systems; their effective use is hindered by the fact that defined strategies, which consider organisational and project requirements, are currently missing (Bouchlaghem, 2012). Conflictingly, the complexity, amount of specialisation and individual project needs do not permit the process to be defined in an explicit way. Dynamically changing process of SBD, requires a highly flexible structured workflow management system (Chung et al., 2003).

Crawley and Aho (1999) describe building design as a 'top-down' process where the original concept is worked towards detailed design, allowing a coordination between parties involved. In contrast, performance assessment follows the reverse route and is a 'bottom-up' process where environmental performance is synthesised based on characteristics and technical details of the building elements. In SBD, the bottom-up

processes should inform the top-down managerial process in order to achieve quality assurance for a holistic sustainable outcome. This assimilation presents a significant challenge to the management of SBD process, which is exacerbated by other factors affecting the quality of the final design, such as lack of coordination in design, unclear or missing information, and poor workmanship (Cnudde et al., 1991; Hammarlund and Josephson, 1991; Burati Jr et al., 1992; Love and Li, 2000). Despite the increasing adoption of ICT, day-to-day communication relies mainly on face-to-face meetings, or basic media such as phone and email. This fact undermines the importance of the contribution of certain disciplines at the early stages of design by making it ad hoc despite in reality being crucial for sustainable design. The actors' roles within the multidisciplinary design team need to be re-defined to reflect the necessary relations between a number of diverse and interdependent tasks and activities. As the scale and scope of cooperative tasks is increasing, the shared level of responsibility for design aspects should be reflected in the use of collaborative systems, and thus, defined so as processes become more transparent and understood among the project's stakeholders. This research is intended to develop a process model for SBD, which can assist current industry practices to depart from ad hoc collaboration workflows. The following section frames the research problem and identifies the gaps in existing knowledge.

Collaborative SBD process and the potential of BIM: a review of literature

Previous attempts to integrate sustainability considerations with the building design process, lack the element of sequencing of activities (Cinquemani and Prior, 2010; Bordens and Abbott, 2002; Reigeluth, 1999), and reasoning of decisions (Potts and Bruns, 1988; Lewis and Mistree, 1998). This problem is further exacerbated by the varying information needs of design disciplines (Brahme, Mahdavi, Lam, and Gupta, 2001), which result in difficulties to make optimal design decisions. Organisational approaches for collaborative design (Mendler and Odell, 2000; Laseau, 2001) have resulted in generic descriptive models of the design process, such as the RIBA Plan of Work 2013 (RIBA, 2013). RIBA (2013) considers sustainability in a checklist, and does not integrate them into the design process along with the core objectives.

Appropriate use of ICT (as a way of working in BIM) could facilitate integration of sustainability in the process, but it is likely to happen ‘only if the design managers employ a structured, systematic approach’ (Pala and Bouchlaghem, 2012). This approach to information management would ensure that participants acquire the right information at the right time. Centralisation of information in a Common Data Environment (CDE), *"an online place for collecting, managing and sharing information"* (BSI, 2013), would allow high level of coordination. Online collaboration platforms (e.g. Viewpoint, Asite, Conject) facilitate a CDE for communication of project information among the project teams (Anumba, Baugh, and Khalfan, 2002). For SBD, the need for coordinating a larger amount of information from a wider range of participants, as supported by CDEs, increases significantly (Bouchlaghem et al., 2005; Yang, Zou, and Keating, 2013).

Although BIM adoption in the UK has increased in recent years (NBS, 2015), there is scant evidence that sustainability has been systematically considered as an integral part of the BIM collaborative process. While in theory nD modelling has been made possible by the technological advancements, in practice it has not been effectively implemented in a holistic way. Some BIM related frameworks are based on the international assessment rating systems (Nofera and Korkmaz, 2010; Biswas and Tsung-Hsien Wang, 2008; Wong and Fan, 2012; Sinou and Kyvelou, 2006; Ghosh et al., 2011; Lützkendorf and Lorenz, 2006), while others have created tools that are integrated into BIM design software to automate performance based decision making (Schlueter and Thesseling, 2009; Welle et al., 2011; Feng et al., 2012; Huber et al., 2011; Mahdavi et al., 2001). Organisational aspects of BIM-enabled sustainable design have not been addressed sufficiently in the literature. The biggest challenge that this incorporation faces is the lack of coordination among people, tools, deliverables, and information requirements (Ruikar, Anumba, and Carrillo, 2006; Succar, Sher, and Williams, 2012; Succar, 2009).

Despite the various performance improvement initiatives (e.g. BIM mandate, Cabinet Office, 2011), the current business model in the construction industry remains highly fragmented. This fragmented way of working does not promote interactions between stakeholders, resulting in “lonely” Level 1 BIM maturity, instead of collaborative Level 2 BIM maturity (Cabinet Office, 2011). There is still no comprehensive and structured process to assist professionals for planning and delivery of SBD, from the early stages, so as to

harness the intellectual inputs of all building professionals' disciplines. Due to the absence of a well-defined process, the implementation of a collaborative system takes place in an ad hoc manner (Bouchlaghem, 2012). Due to the iterative nature of the design process and the complex interrelationships between disciplines, the management of this ad hoc process becomes difficult from the early stages.

A review of literature, as summarised in this section, suggests a lack of a common definition for a BIM-enabled sustainable design process. Sustainable design remains subject to interpretation, and ad hoc processes are common. As each discipline works in isolated silos, the design outcome is compromised by failing to capture and integrate their inputs in a timely fashion. Clear definition of a multidisciplinary SBD process will assist practitioners to work collaboratively and add value to the design by harnessing the intellectual inputs of the various stakeholders.

The scope of this research is to integrate the BIM framework (Succar, 2009) with the definition for sustainability (Rodriguez, 2002), emphasising on the environmental dimension of the SBD process. This research attempts to identify lessons learnt from the best practices so that it can be used to inform the design of sustainable buildings in the future. It is intended to identify the components of SBD and develop a process model, which can assist industry practices to depart from ad hoc collaboration workflows.

Research methods

This research has adopted an abductive approach (iterative process of induction and deduction) using multiple case studies (Dubois and Gadde, 2002; Levin-Rozalis, 2004; Reichertz, 2004; Svennevig, 2001). First, content analysis (Elo and Kyngäs, 2008) has been utilised to identify the components of SBD and develop the framework presented in section "SBD process components". The framework contains the components that enable the use of BIM workflows during multidisciplinary collaboration. Then, a structured process that coordinates the SBD variables (roles, tasks, information requirements, and sustainability criteria) is illustrated in section "SBD process decomposition". The research adopts the concept of Concurrent Engineering (CE), which is a holistic approach to the design, development and production of a product (Love, Gunasekaran, and Li, 1998); CE is an effort to effectively integrate all aspects of product

development, by performing simultaneously a variety of activities that used to be done sequentially.

The Integrated DEFinition (IDEF) compendium of methods have been designed to support information integration within CE systems that achieve better performance in terms of efficiency (Mayer et al., 1995). IDEF0 and IDEF3 process modelling techniques are used to map the interdependencies of components, based on the narratives of design team members collected using the Critical Decision Method (CDM) (Klein, Calderwood, and Macgregor, 1989). The following section explains the techniques adopted for collecting, analysing, and interpreting data. Figure 1 illustrates the design and phases of this research.

Selection of interviewees

A non-probabilistic, purposive sampling approach was followed based on selection criteria for the best practices. Expert Sampling (Klein, Calderwood, and Macgregor, 1989), which is a sample of persons with known or demonstrable experience and expertise in the area, has been selected. The best practices are defined as the ones that manage to achieve sustainability objectives in the most economically efficient way in terms of time, cost, and effort involved. The interviewees were selected based on relevant educational background, industry experience (5 to 25 years), involvement in award-winning projects for sustainability, and for being part of organisations with BIM adoption policy.

Data collection

During three years, three sets of in-depth interviews were conducted, resulting in a total of 25 semi-structured interviews with industry experts from 15 organisations. The procedure of the CDM consisted of: (i) selection of an incident that had a significant effect on the sustainability outcome (positive or negative), (ii) unstructured account of incident followed by questions to build context, (iii) construction of incident timeline, (iv) identification of critical decision points, (v) decision points' probes to obtain justifications, (vi) incident reflection and suggestions. Ten (10) 'best practice' case studies were identified and 20 incidents' narratives were collected to examine roles and responsibilities, resources, information exchanges, interdependencies, timing and sequence of events, and decisions points. In total, they have resulted in 24

hours of recorded material. Reports and documents were also collected for theoretical triangulation. Table 1 provides a summary of the Case Studies performed and the design roles interviewed for each case.

Data analysis

Phase 1 of the research has been exploratory, conducted to investigate current practices of sustainability integration with BIM processes. It has resulted in the development of a conceptual framework for the components of SBD by combining content with thematic analysis. Additionally, an IDEF0 process model (KBSI, 1993) was created following the RIBA (2013) process. The IDEF0 model was presented to the industry practitioners, validated for its accuracy, and enriched by more information performing exploratory and predictive iterations (Yin, 2013). Although IDEF0 is widely used in research due to its clarity of modelling activities and information flows, it cannot support information process flows or capture concurrent processes and there is no consideration of time (Mayer and DeWITTE, 1999). IDEF3 overcomes the shortcoming of IDEF0 by capturing descriptions about sequences of activities, while also identifying milestones of the process from different perspectives (Mayer et al., 1995). The IDEF3 method manages to remain simple while maintaining a high descriptive power (Dorador and Young, 2000). Table 2 shows the symbols used for the process description schematics. The IDEF0 method uses the ICOM (Input, Control, Output, and Mechanism) (KBSI, 1993). In IDEF3, the boxes represent real world processes as happenings; those are referred to as Units of Behaviour (UOB). The arrows that connect the boxes indicate precedence between actions. The junctions represent constraints and enable process branching. The junctions involve choices among multiple parallel or alternative sub-processes. The logical decisions include: AND (&), OR (O), EXCLUSIVE-OR (X), and synchronous or asynchronous start and finish of the processes. The objects are represented as circles that show their different states connected with arrows that have UOB's referents to indicate the entry, transition, state and exit conditions (Mayer et al., 1995).

Phase 2 consisted of two distinct sets of data collection. During the first set, the workflows were initially structured into separate IDEF3 models so as to identify patterns and relationships between them (exploratory identification of variables and properties). Then, the models were synthesised into a single IDEF process

decomposition. This has assisted in identifying gaps in the model. The second set was iterative, serving to validate the relationships that had been identified previously, and also completing the missing information. The resulted process model consisted of four level hierarchies (high to detail). During the final interviews, the protocol followed the IDEF process model structure. This process continued until no further information, related to the research questions, was provided by the experts (theoretical saturation) (Glaser and Strauss, 2009).

SBD process components

The framework of components, presented in this section, provides the descriptions of the elements that constitute the SBD process. First, the components were identified and defined utilising content analysis (Elo and Kyngäs, 2008) and thematic analysis (Braun and Clarke, 2006). In section “SBD process decomposition”, these components were coordinated into a holistic process that establishes their interdependencies explicitly. Figure 2 presents the three levels of abstraction considered during the data analysis. “BIM-enabled Sustainable Design Process” is the main category of the classification. “Roles”, “Tasks”, “Deliverables”, and “Decision points” are the generic categories of the framework. “Contractual agreements” is an example of a sub-category of the generic category “Roles”.

Roles, responsibilities (contractual agreements) and competencies (training)

Given the requirements of multidisciplinary collaboration for SBD, specialised roles and responsibilities are needed. Although new roles have been identified to accommodate the core BIM uses (Barnes and Davies 2014), the SBD roles have not been sufficiently defined yet (Barlow, 2011; Sinclair, 2013). In addition to traditional roles (e.g. client, architect, structural engineer), specialist roles from a range of expertise are required, including BIM manager, BIM information manager, BIM coordinator, BPA specialist, and Sustainability Consultant.

Tasks (activities) and implementation methods (inputs and outputs)

This sub-section discusses the opportunities, challenges, and limitations for the implementation of BIM-enabled SBD tasks utilising the existing technological enablers.

BIM software use

The selection of BIM software tools varies according to the type of project. Large organisations utilise a variety of software packages so as to combine the strengths of different tools. The interviewees stressed, however, that BIM is more about the ‘information tree’ process and less about the ‘software’ tools.

“... it is almost as a little tree of decision making... so rather than getting information out at one stage, you need broad scale of thinking at one stage and then slightly more detail, and then slightly more detail again. So you get to the full detail again for performance. What you tend to do is get no information, no information, no information and then at the end get full data sheet, full information, full performance, full modelling, full testing at that point its kindda too late.” Architect/Sustainability Consultant

Twenty interviewees out of twenty-five (20/25) are using the Revit suite for designing. Other tools used are ArchiCAD (2/25), Microstation (2/25), CATIA (1/25) and AECOsim (1/25).

BPA software use

A wide range of BPA tools were utilised depending on the sustainability criteria being examined and the stage of design at which analysis takes place. Architects argued the importance of having quick feedback at early stages of design when the building form is developed. Tools like PHPP (2/25), Sefaira (2/25), and EcoDesigner (1/25) are used for this purpose. However, for signing off concept design, detailed simulation is still needed, by a Sustainability Engineer utilising an NCM accredited dynamic simulation software package. The interviewees nominated the following accredited software packages: IES VE (5/25), DesignBuilder (1/25), Bentley Hevacomp (1/25), and TAS (1/25).

Software interoperability

A major enabler to achieve integration of BPA with BIM collaboration is interoperability. Figure 3 illustrates the interoperability workflows between BIM authoring tools and the dynamic simulation NCM

accredited software. The figure shows that geometric information and properties of BIM models, if designed properly, can be seamlessly translated to be understood by BPA software tools. However, as it has been reported by the participants, the opposite process is not possible at the moment. This fact is a technological limitation that hinders integration of sustainability information directly into BIM.

Utilisation of CDE

Sustainability Engineers did not utilise CDEs for collaboration. One interviewee emphasised that *“I am a sustainability specialist, I am not a specialist in BIM”*, arguing that sustainability is not relevant to BIM collaborative processes. This viewpoint reflects the current state of implementing sustainability, and the lack of achieving nD modelling in practice. Furthermore, coordinating sustainability information that was required for BREEAM assessment was done manually, and was ad hoc. One interviewee reported that *“sometimes we use the Tracker Plus system”*, but *“typically all things happen via email”* (BREEAM Assessor). As a result, BREEAM assessors spend a significant amount of time coordinating and validating the information provided by the project team.

“It [BIM] has not affected the way I personally, manage sustainability... It is very important to embrace BIM because there are some very good efficiencies to be achieved if everyone is on board, if the design team is on board in a process of working together, using the same process.” Sustainability Consultant/BREEAM Assessor

The interviewees argued that current platforms were not suited for coordinating the delivery of SBD, because they were not designed for this purpose. The interviewees suggested the need for a platform that integrates sustainability considerations within a BIM-enabled collaborative process.

“I can see that being very valuable in the whole design process. But it’s still something under development.... There hasn’t been a platform developed for sustainability just yet.” Sustainability Engineer/BREEAM Assessor

Deliverables and information requirements (format specification)

The findings show that despite the capabilities of BIM software, there is consensus among the designers that

the design process is heavily driven by 2D drawings. Despite working in Level 2 BIM projects, the interviewees argued that it had not affected collaboration with other disciplines in a way that is anticipated in theory. One interviewee argued that “*whether you do it in 2D or 3D or if you do hand drawings; fundamentally that will be the same*” (Architect). Antithetically, a more streamlined process has been documented (CS5/Architect), inserting climate data and sustainability targets into the geometric model before sharing it with the sustainability specialists for BPA.

Critical decision points and benchmarks (rules, regulations, directives)

The identification of decision points is discussed in PAS1192:2-2013 (BSI, 2013) as a critical aspect of the BIM process. Decision points in phase-gate review comprise two types of gates; hard-gates when the design freezes until the review is conducted, and soft-gates that allow the project to proceed in parallel, thus enabling a CE approach to SBD. The hard-gates serve the purpose of committing to decisions collectively. Additionally, soft-gates are identified throughout the process so as the decision making points occur in parallel. The benefit of implementing soft phase-gate reviews is that the project is allowed to proceed in parallel with conducting the review. In order to achieve sustainability objectives, design strategies are implemented and assessed towards a set of criteria and benchmarks. The timing when these decisions take place is crucial, since once commitments have been made early in the process, it is more costly to repeat the work that has already been done. To achieve that, the right information should be delivered to the right people at the right time. Identifying critical decision points assists in determining the loops of an iterative design process. A mapped process that can be audited, along with soft-gates and hard-gates for SBD, would provide assurance that the sustainability objectives would be met.

The IDEF3 model’s Junctions serve the purpose of providing soft-gates in the process of integrating sustainability considerations and criteria at the right time. Table 3 includes the performance criteria identified from the case studies’ narratives aligned with the Junctions of the IDEF3 decomposition.

SBD process decomposition

This section discusses the SBD components coordinated into a holistic CE process. The process model developed, utilising IDEF0 and IDEF3 notations, aligns with RIBA's (2013) stages 0 (Strategic Definition), 1 (Preparation and Brief), and to 2 (Concept Design) (depicted in Figure 4). These stages correspond to the three stages of briefing; Strategic, Initial, and Final, respectively. The definition of sustainability is re-framed as the level of detail increases. Sustainability aspirations need to be expressed qualitatively at stage 0, then, quantified (e.g. metrics, benchmarks) at stage 1, and finally, tested and defined explicitly at stage 2. Feasibility of the criteria is the basis for optimising the design, by performing iterations at Concept Design stage. Therefore, it is important for design practitioners to ask the appropriate questions at each stage of the design process.

Figure 5 presents the IDEF model's master-map, which consists of three level hierarchies. Level 1 represents the high-level IDEF0 process model decomposition aligning with the RIBA's (2013) hard decision gates, and colour-coded accordingly. Level 2 contains the decompositions (sub-processes) of the Level 1 process. Level 3 contains the decompositions of the Level 2 processes. Levels 2 and 3 (IDEF3) provide granularity that demonstrates which functions are performed by each role, parallel activities, and soft-gates. The coloured UOBs are further decomposed into Level 3 and Level 4 sub-processes, which are not discussed in this paper. Table 4 contains the three levels of IDEF decomposition diagrams and Table 5 the inputs and outputs of each UOB. The diagrams provide a simplified description of the relationships between BIM-enabled sustainability functions (as UOBs), and the gateways (as Junctions) for the iteration cycles of the SBD collaborative process. The inputs (information required) and outputs (information shared) of the functions are illustrated as Objects. The Objects' states (e.g. Initial, Optimised, Approved, Shared) change as they are altered by the functions.

Stage 0: Strategic Definition - NEED

The collaborative project team needs to be established at RIBA Stages 0 and 1 (Sharp, Finkelstein, and Galal, 1999; Sinclair, 2013). This practice can facilitate the development of a robust project brief by

combining the perspectives of the multidisciplinary team. After the Client's intent is clarified, the necessary appointments of design team members need to be made accordingly. Adoption of a common language for job titles, descriptions, and responsibilities would lead to clear objectives for the project management of sustainable buildings. This research has identified the main roles and responsibilities for SBD, presented in Table 6.

It has been noted, by the Sustainability Engineers, that consultation directly with the Client at the briefing stage has recently become a lot more common. An Architect described that when the Client has clear sustainability aspirations, a Sustainability Engineer has performed early calculations for feasibility (climate analysis, site analysis) even before the Briefing stage has begun.

“Traditionally, years ago, we were appointed by the architect, once they have almost won the competition and that's too late to have any influence on the design. ...the planning rules and the regulations mean you've got to do stuff much earlier on... They say... we need some input much earlier on so we don't waste money.” Sustainability Engineer

Combining findings from the interviewees with the literature, there are three key objectives for SBD: occupant comfort and health, environmental impact, and client satisfaction/approval along with the commercial aspects of building design. A holistic approach is needed that encompasses all the above aspects. However, the client's sustainability aspirations were often manifested solely through formal certification and benchmark:

“The big one really is BREEAM and what rating you want to get and then everyone knows what they are aiming to do. But, there are other things as well, such as EPC rating and a number of benchmarks really of what they want to achieve and that is probably the most important thing, I would say.”

Architect/Sustainability Consultant

The Level 2 decomposition of UOB 0 “Undertake Strategic Definition” (see Table 4) requires the inputs shown in the Level 1 hierarchy model, which are the Plain English Questions, Occupants' Needs, Environmental Impact, and Client's Aspirations. Then, UOBs 0.1, 0.2, 0.3, and 0.4 (and their sub-processes) are performed in parallel. The outputs of this function are the Strategic Brief, Employer's Information

Requirements (EIR), Team Appointments, Project Objectives (e.g. BREEAM, Passivhaus), and Sustainability Aspirations (e.g. daylight performance, embodied carbon, renewable sources).

Stage 1: Preparation and Brief - EXECUTION

At Stage 1, the design team's values are added to the Client's sustainability aspirations, and become more detailed, as feasibility studies start. The result of this process sets specific benchmarks for sustainability as part of the Initial Project Brief. The interviewees suggested that sustainability aspirations are expressed in both extremes, from very detailed (usually commercial clients) to very vague, and everything in between, depending on how informed the Client is. In the case of a vague client brief, it is the Lead Designer's/Project Lead's responsibility to clarify expectations by consulting the Client before engaging the appropriate specialist subcontractors:

“We have to be proactive, if the client doesn't have any aspirations. For example, the lifecycle of materials, where the client might not have an understanding about the design life or any requirements. We would put a proposal to them. You can start to discuss how certain elements of the building would have an effect. You have to inform the client.” Architect

UOB 1 “Prepare Project Brief” (see Table 4) requires the outputs of UOB 0 as inputs. The main activities that need to take place during this stage are the development of a BIM Execution Plan (BEP) and Schedule of Services (UOBs 1.1 to 1.5), based on the information contained in the EIR. When EIR are not provided by the Client, it is the Project Lead/Lead Designer's responsibility to form a BEP that states the sustainability targets and implementation strategy, and communicate it with the rest of the design team. Furthermore, the Sustainability Objectives and Benchmarks/Metrics need to be clarified at this point to achieve design team alignment (UOBs 1.1 and 1.2). Then, the decisions and commitments made should be compiled into the Initial Project Brief.

Stage 2: Concept Design - DELIVERY

The interviewees argued that SBD should be an iterative process that involves assessing, revising and re-assessing sustainability as design progresses:

“It is not a milestone, it is a continuous flow of information, backwards and forwards every time someone makes a modification. That information is updated and is mainly on people knowing when you are going to need the information.” Sustainability Director/BREEAM Assessor

Evidently, in cases that the CE approach was not implemented, the interviewees have failed to achieve sustainability goals:

“That analytical full modelling scenario permits us to isolate problems and come up with local solutions for them... If you do it too late in the process, you end up with half-baked solutions... A better solution takes more work upfront and more understanding upfront to be able to do that.” Architect/Sustainability Consultant

An interviewee confirmed that the iterative process of design and assessment has helped to identify the tensions between design objectives so as to make adjustments early in the process. This fact has saved a significant amount of time and has assisted in achieving the project programme:

“if needed to submit an alternative proposal provided planning, section and detail, that could have taken two weeks out of the programme for us and then two weeks to decide whether we should change it, we view it and then, if everything was ok, we would have issued the drawings like that next week...”
Architect/CS4

Once the requirements definition phase is completed (at Stage 1), the climate data, occupancy requirements, and site and topography information are available. The Interviewees described Stage 2 as a process that is divided into four phases of design and assessment loops: (i) building massing; (ii) fabric and layout optimisation; (iii) mechanical systems configuration; and (iv) simultaneous optimisation of building envelope and mechanical services. The functions (UOBs 2.0, 2.1, 2.2, 2.3, and 2.4) of the Level 2 hierarchy decomposition of UOB 2 “Develop Concept Design”, follow this structure (see Table 4). Table 7 synthesises the findings from the interviews (structured and unstructured descriptions) and an extensive literature review survey in order to define the BIM-enabled tasks for sustainable design (as UOBs). Each UOB is defined by the WHY (intent, sustainability aspirations), WHO (role, competencies/training, collaborators), WHAT (information requirements, inputs-outputs), and HOW (creation/processing, software tools, communication methods).

Climate and weather analysis (UOB 2.0) is a critical step of SBD that examines parameters such as temperature ranges, and precipitation. The aim of this task is to identify the appropriate design strategies that can be implemented for a specific location. During this analysis, the Sustainability Engineer generates weather data diagrams (e.g. temperature, humidity, solar radiation, wind roses) and interprets the results presented in a psychrometric chart (comfort zones) to determine the most efficient design strategies for the site. The weather data files are attained either directly by weather stations (e.g. US Department of Energy) or specialised software (e.g. Meteonorm). The user imports the Climate Data file in the software (e.g. Climate Consultant, IES, or Sefaira) and selects the Comfort Zone model of their preference (e.g. Adaptive Comfort Model in ASHRAE Standard 55-2010). Level 2 UOBs of concept design stage (2.1, 2.2, 2.3, and 2.4) have been further decomposed to Level 3 hierarchy (see Table 4), and their information requirements are described in Table 5.

UOB 2.1 “Develop building massing” refers to the perception of the general shape, form, and size of the building. For SBD orientation and location on site are also important considerations for the adoption of passive design strategies such as daylighting and natural ventilation. The energy efficiency of those strategies is assessed by calculating the heating and cooling loads, aiming to reduce them as much as possible. For this reason, a series of analysis must take place (UOBs 2.1.2-2.1.6) before committing to design decisions. If the Architect is not able to perform BPA themselves, they would need to work closely with a Sustainability Engineer. The iterative loop of design and assessment continues until the Architect, Sustainability Engineer, and Client reach an agreement (J4). The output of UOB 2.1 is a generic representation, Level of Development/Detail 100 building mass 3D model, which contains indicative height, volume, location, and orientation (BIM Arch LOD100).

UOB 2.2 “Optimise fabric and layout” is concerned with optimising the fabric performance by utilising passive design strategies (e.g. daylight autonomy, solar gains, natural ventilation, thermal mass effects and night cooling). The objectives of this task are to save energy and cut billing costs, while increasing comfort of the building’s occupants. Building materials (e.g. roofs, walls, windows, doors, and floors) need to be carefully selected based on criteria such as thermal performance, and carbon footprint. Furthermore,

building layouts determine the thermal zones of the building, which are the unit of analysis for performance evaluation simulations. Each thermal zone is defined by the occupancy requirements and operation schedule that vary depending on the function of each space. The iterative loop (design-assessment) continues until the Architect, Sustainability Engineer, Structural Engineer, and Client reach an agreement (J8).

UOB 2.3 “Configure mechanical services” examines system comparison and selection, along with planning of sustainable active design strategies. Once the architectural, structural, and mechanical BIM models are developed, they should be coordinated utilising appropriate software (e.g. Navisworks, Solibri) in order to identify and resolve design clashes. The output of UOB 2.3 is a coordinated BIM LOD200 model that consists of generic placeholders graphically represented as a generic system, object, or assembly with information attached.

UOB 2.4 “Develop holistic concept” entails the optimisation of the concept by examining the trade-offs between design elements in more detail (UOBs 2.4.6-2.4.13). Here, the Client, Architect, MEP (mechanical, electrical, and plumbing) Engineer, Structural Engineer, Sustainability Engineer, and Cost Consultant/Contractor should work collectively until the design criteria are met (J17).

Discussion and lessons learnt

Due to the fragmented way of working, the existing building design process does not effectively permit the integration of sustainability considerations from the early design stages, hence compromising the achievement of sustainability objectives. ICTs offer a significant potential to develop an integrated SBD process with robust BPA, but re-thinking of existing processes is required (Garber, 2009). To make a step change towards sustainable development, assisted by the new technological improvements (software, hardware and networks), there is the need to specify the components and processes of BPA within BIM collaboration. The challenge that this incorporation faces is the co-ordination of all available elements which are necessary to achieve optimum results (Ruikar et al., 2006). To do this, critical SBD decisions should be considered timely in order to assess trade-offs between design aspects that are delegated to disciplines with varying aspirations. Therefore, the purpose of this research is to identify critical components and develop a SBD process model. The aim is to make explicit what is currently tacit among SBD experts and increase

understanding of the implications of certain design decisions. As demonstrated by the case studies, learning from experience can facilitate the creation of a more detailed process to guide future projects so as to avoid repeating mistakes. The IDEF process model coordinates ‘bottom-up’ BPA with ‘top-down’ organisation of stakeholders, as their inputs are brought early in SBD. Several lessons learnt from the case studies are described in the following sub-sections.

Specifying roles, tasks and deliverables

In order to enable (BIM) technologies to achieve their full potential, the roles within the design team need to be clarified, along with the tasks and deliverables, in order to become meaningful and useful for multidisciplinary collaboration. Instead of design participants working in isolated silos, between the hard-gates (start and end of concept design), the soft-gates identified during the Work in Progress (WIP) (BSI, 2013) can facilitate communication as well as clarify the process for novice practitioners to reduce uncertainty. The IDEF3 model developed in this research, can be utilised within a CDE to facilitate the implementation of collaborative SBD process and the delivery of concept design. The contribution of roles in design development reveals a front-loaded process for SBD, as described in the MacLeamy curve (CURT, 2004).

Repeatable detailed tasks

The findings show that the process can be mapped in a more detailed manner than the RIBA (2013). The collaborative patterns, at concept design stage, are found to be repeatable for a variety of different non-domestic building types such as education, healthcare, and offices. Thus, repeatable tasks and similar workflow patterns, roles and responsibilities have been identified. This fact enables the development of a systematic approach to SBD, based on CE principles (Love and Gunasekaran, 1997; Gunasekaran and Love, 1998). This approach would allow lessons learnt to be incorporated for the design of future buildings.

Need to redefine the design process

It was found that traditional working processes cannot be employed to achieve complex, high-performing

buildings and that a CE design process approach is essential. During the traditional building design process, each stakeholder passes fixed information to the next one, which results in compromised design outcomes. What the CE approach for SBD suggests is that design solutions are developed, assessed and revised collaboratively, as design progresses. A single linear prescribed process is not viable for SBD because the complexity, amount of specialisation and individual project needs do not permit the process to be defined without iterations. The proposed SBD process, combines the sequential principles found in organisational design theory (task-oriented network) (Laseau, 2001) with the spiral metaphor (from abstract to concrete design concept) of the design process (Goldschmidt, 1942-2014; Watts, 1966).

Formal and informal communication in a centralised system

The issue of informal and formal communication also emerged from the case studies. Drawings, contractor's programmes, and other information represent formal communication, and day-to-day communication represents informal organisation. Inconsistencies between the two are due to the lack of project team alignment for SBD. The interviewees described the role of the Sustainability Engineer as prominent, in the early design stages. However, their collaboration cannot be secured, with the current procurement methods, since in most cases their communication with the Architect occurs informally and is not recorded in the ICT systems. Therefore, their contribution in the design process is severely underestimated. In order to move from spider-web communication architecture to a hub-centric one (within a CDE), the existing communication patterns need to be understood to inform the centralised system.

Conclusion

This research has presented a holistic and systematic process for BIM-enabled SBD for the early stages. First, a framework of the critical components of SBD (roles, responsibilities, tasks, deliverables, and decision points) has been presented. Then, the timing and sequencing of the components' sub-categories have been defined into a common CE process model. The IDEF process model allows 'bottom-up' sustainability considerations and 'top-down' coordination between the stakeholders. The model can be utilised within a CDE to facilitate the collaborative process at concept design stage. Nevertheless, it is

acknowledged that a single linear prescribed process is not viable for SBD, because the complexity, amount of specialisation, and individual project needs, do not permit the process to be defined without iterations. Additionally, the research has identified that the role of the Sustainability Engineer is prominent in the early design stages and is best suited to achieve a sustainable outcome. Essentially, it has been argued that a transparent SBD process that follows a specified communication pattern, can assist in achieving SBD efficiently in terms of time, cost, and effort. Further work, is thus, required to bring this framework and process into real life projects, where the efficacy of the approach could be tested.

Acknowledgements

The research team would like to thank the participating industry experts for their contributions and time given in the interviews, as well as for their continuous support and correspondence.

References

- Anumba, C. J., Baugh, C., and Khalfan, M. M. (2002). Organisational structures to support concurrent engineering in construction. *Industrial management and data systems*, 102(5), 260-270.
- Attia, S., Beltrán, L., De Herde, A., and Hensen, J. (2009). Architect friendly: a comparison of ten different building performance simulation tools. In *Proceedings of IBPSA '09 Buildings Simulation Conference*, University of Strathclyde, Glasgow, Scotland 27th - 30th July, 204–211.
- Azhar, S., Carlton, W. A., Olsen, D., and Ahmad, I. (2011). Building information modeling for sustainable design and LEED® rating analysis. *Automation in Construction*, 20(2), 217–224.
- Barlow, S. (2011). *Guide to BREEAM*. London: RIBA Publishing.
- Barnes, P., and Davies, N. (2014). *BIM in principle and in practice*. London: ICE Publishing.
- Biswas, T., and Tsung-Hsien Wang, R. K. (2008). Integrating sustainable building rating systems with building information models. Retrieved from http://cumincad.scix.net/data/works/att/caadria2008_24_session3a_193.content.pdf

- Bordens, K. S., and Abbott, B. B. (2002). *Research design and methods: A process approach*. McGraw-Hill.
- Bouchlaghem, D. (2012). *Collaborative Working in Construction* (Vol. 1st). 2 Park Square, Milton Park, Abingdon, Oxon OX14 4RN: SPON Press.
- Bouchlaghem, D., Shang, H., Anumba, C. J., Cen, M., Miles, J., and Taylor, M. (2005). ICT-enabled collaborative working environment for concurrent conceptual design. *Architectural Engineering and Design Management*, 1(4), 261–280.
- Brahme, R., Mahdavi, A., Lam, K. P., and Gupta, S. (2001). Complex building performance analysis in the early stages of design. In *Seventh International IBPSA Conference*, 13-15 August 2001, Rio de Janeiro, Brazil, 661–668.
- Braun, V., and Clarke, V. (2006). Using thematic analysis in psychology. *Qualitative Research in Psychology*. Retrieved from <http://www.tandfonline.com/doi/abs/10.1191/1478088706qp063oa>
- BSI. (2013). *PAS 1192-2:2013 - Specification for information management for the capital/delivery phase of construction projects using building information modelling*. Available at: <http://shop.bsigroup.com/Navigate-by/PAS/PAS-1192-22013/>: CIC.
- Burati Jr, J. L., Farrington, J. J., and Ledbetter, W. B. (1992). Causes of quality deviations in design and construction. *Journal of Construction Engineering and Management*, 118(1), 34–49.
- Cabinet Office (2011). *Government Construction Strategy*, May 2011. Retrieved from <https://www.gov.uk/government/publications/government-construction-strategy>
- Chung, P. W. H., Cheung, L. Y. C., Stader, J., Jarvis, P., Moore, J., and Macintosh, A. (2003). Knowledge-based process management – an approach to handling adaptive workflow. *Knowledge-Based Systems*, 16(3), 149–160.
- Cinquemani, V., and Prior, J. J. (2010). *Integrating BREEAM throughout the design process: a guide to*

achieving higher BREEAM and code for sustainable homes ratings through incorporation with the RIBA outline plan of work and other procurement routes. Bracknell: IHS/BRE Press.

- Cnudde, M., Bezelga, A., and Brandon, P. S. (1991). Lack of quality in construction—economic losses. *Management, Quality and Economics in Building*, 508–515. Retrieved from [https://books.google.co.uk/books?hl=en&lr=&id=fQKRAGAAQBAJ&oi=fnd&pg=PA461&dq=Cnudde,+M.,+Bezelga,+A.,+and+Brandon,+P.+S.+\(1991\).+Lack+of+quality+in+construction%E2%80%94economic+losses.+Management,+Quality+and+Economics+in+Building,+508%E2%80%93515.&ots=d34RPTvPh1&sig=spCbySrJqzUAjiUreyiMVXYGLGo#v=onepage&q&f=false](https://books.google.co.uk/books?hl=en&lr=&id=fQKRAGAAQBAJ&oi=fnd&pg=PA461&dq=Cnudde,+M.,+Bezelga,+A.,+and+Brandon,+P.+S.+(1991).+Lack+of+quality+in+construction%E2%80%94economic+losses.+Management,+Quality+and+Economics+in+Building,+508%E2%80%93515.&ots=d34RPTvPh1&sig=spCbySrJqzUAjiUreyiMVXYGLGo#v=onepage&q&f=false)
- Crawley, D., and Aho, I. (1999). Building environmental assessment methods: applications and development trends. *Building Research and Information*, 27(4-5), 300–308.
- Crawley, D. B., Hand, J. W., Kummert, M., and Griffith, B. T. (2008). Contrasting the capabilities of building energy performance simulation programs. *Building and Environment*, 43(4), 661–673.
- CURT. (2004). *Collaboration, Integrated Information, and the Project Lifecycle in Building Design, Construction and Operation*. Retrieved from <http://codebim.com/wp-content/uploads/2013/06/CurtCollaboration.pdf>
- Dubois, A., and Gadde, L.-E. (2002). Systematic combining: an abductive approach to case research. *Journal of Business Research*, 55(7), 553–560. [http://doi.org/10.1016/S0148-2963\(00\)00195-8](http://doi.org/10.1016/S0148-2963(00)00195-8)
- Elo, S., and Kyngäs, H. (2008). The qualitative content analysis process. *Journal of Advanced Nursing*. Retrieved from <http://onlinelibrary.wiley.com/doi/10.1111/j.1365-2648.2007.04569.x/full>
- Feng, C.-W., Mustaklem, O., and Chen, Y.-J. (2012). The BIM-based information integration sphere for construction projects. In *Proceedings of the 28th ISARC Conference, Seoul, Korea* (pp. 156–161).
- Garber, R. (2009). Optimisation Stories: The Impact of Building Information Modelling on Contemporary Design Practice. *Architectural Design*, 79(2), 6–13.

- Ghosh, S., Negahban, S., Kwak, Y. H., and Skibniewski, M. J. (2011). Impact of sustainability on integration and interoperability between BIM and ERP-A governance framework. In *Technology Management Conference (ITMC), 2011 IEEE International* (pp. 187–193). IEEE.
- Glaser, B., and Strauss, A. (2009). *The discovery of grounded theory: Strategies for qualitative research*. Retrieved from [https://books.google.co.uk/books?hl=en&lr=&andid=rtiNK68Xt08C&doi=fndandpg=PP1&dq=Glaser,+Barney+%26+Strauss,+Anselm+\(1967\).+The+discovery+of+grounded+and+dots=UVy_RhWHZP&sig=-2Bd0JziNHUSygXy9dBIHG6VAdE](https://books.google.co.uk/books?hl=en&lr=&andid=rtiNK68Xt08C&doi=fndandpg=PP1&dq=Glaser,+Barney+%26+Strauss,+Anselm+(1967).+The+discovery+of+grounded+and+dots=UVy_RhWHZP&sig=-2Bd0JziNHUSygXy9dBIHG6VAdE)
- Goldschmidt, G. (2014). *Linkography unfolding the design process*. Cambridge, Massachusetts ; London: The MIT Press.
- Gunasekaran, A., and Love, P. E. D. (1998). Concurrent engineering: a multi-disciplinary approach for construction. *Logistics Information Management*, 11(5), 295–300.
- Haapio, A., and Viitaniemi, P. (2008). A critical review of building environmental assessment tools. *Environmental Impact Assessment Review*, 28(7), 469–482.
- Hammarlund, Y., and Josephson, P.-E. (1991). Sources of quality failures in building. In *Proceedings of the European Symposium on Management, Quality and Economics in Housing and other Building Sectors, Lisbon, Portugal* (Vol. 30, pp. 671–679). Wiley.
- Huber, D., Akinci, B., Oliver, A. A., Anil, E., Okorn, B. E., and Xiong, X. (2011). Methods for automatically modeling and representing as-built building information models. In *Proc., NSF CMMI Research Innovation Conference*, 4-7 January, Atlanta, GA.
- Klein, G. A., Calderwood, R., and Macgregor, D. (1989). Critical decision method for eliciting knowledge. *Systems, Man and Cybernetics, IEEE Transactions on*, 19(3), 462–472.
- Knowledge Based Systems Inc. (KBSI). (1993). *Integration DEFINITION for function modeling (IDEF0)*.

Retrieved from <http://www.idef.com/pdf/idef0.pdf>

Laseau, P. (2001). *Graphic Thinking for Architects and Designers*. John Wiley and Sons.

Levin-Rozalis, M. (2004). Searching for the unknowable: A process of detection—Abductive research generated by projective techniques. *International Journal of Qualitative Methods*. Retrieved from <http://ijq.sagepub.com/content/3/2/1.short>

Lewis, K., and Mistree, F. (1998). Collaborative, sequential, and isolated decisions in design. *Journal of Mechanical Design*, 120(4), 643–652.

Love, P. E. D., and Gunasekaran, A. (1997). Concurrent engineering in the construction industry. *Concurrent Engineering*, 5(2), 155–162.

Love, P. E. D., Gunasekaran, A., and Li, H. (1998). Concurrent engineering: a strategy for procuring construction projects. *International Journal of Project Management*, 16(6), 375–383.

Love, P. E. D., and Li, H. (2000). Quantifying the causes and costs of rework in construction. *Construction Management and Economics*, 18(4), 479–490.

Lützkendorf, T., and Lorenz, D. P. (2006). Using an integrated performance approach in building assessment tools. *Building Research and Information*, 34(4), 334–356.

Mahdavi, A., Brahme, R., and Gupta, S. (2001). Performance-based computational design via differential modeling and two-staged mapping. In *Proceedings of the CAAD Futures Conference*. Eindhoven, The Netherlands (pp. 667–680).

Mayer, R. J., Menzel, C. P., Painter, M. K., Dewitte, P. S., Blinn, T., and Perakath, B. (1995). *Information integration for concurrent engineering (IICE) IDEF3 process description capture method report*. DTIC Document.

Mendler, S., and Odell, W. (2000). *The HOK guidebook to sustainable design*. John Wiley and Sons.

- NBS. (2015). *NBS National BIM Report 2015*. UK: National Building Specification (NBS).
- Nofera, W., and Korkmaz, S. (2010). Design Process Integration for Sustainable, High Performance Buildings. 4-7 November 2010, South Lake Tahoe, CA. Retrieved from http://www.academiceventplanner.com/EPOC2010/Papers/EPOC_2010_NoferaKorkmaz.pdf
- Pala, M., and Bouchlaghem, N. M. (2012). How could ICT benefit design managers for assessing sustainability of their project? proceeding of the 7th International Conference on Innovation in AEC, 15-17 August 2012, São Paulo, Brazil.
- Peña-Mora, F., Hussein, K., Vadhavkar, S., and Benjamin, K. (2000). CAIRO: a concurrent engineering meeting environment for virtual design teams. *Artificial Intelligence in Engineering*, 14(3), 203–219.
- Potts, C., and Bruns, G. (1988). Recording the reasons for design decisions. In *Proceedings of the 10th international conference on Software engineering*, 11-15 April 1988, Singapore, 418–427. IEEE Computer Society Press.
- Reichertz, J. (2004). 4.3 Abduction, deduction and induction in qualitative research. *A Companion to*. Retrieved from <https://books.google.co.uk/books?hl=enandlr=andid=IRSL1KJjEPoCandoi=fndandpg=PA159anddq=reichertz+a+rule-governed+way+to+new+knowledgeandots=eMH0devcJoandsig=4NWvGO8XucSdPuCCMjir7P-bXP8>
- Reigeluth, C. M. (1999). The elaboration theory: Guidance for scope and sequence decisions. *Instructional Design Theories and Models: A New Paradigm of Instructional Theory*, 2, 425–453.
- RIBA. (2013). RIBA Plan of Work 2013. Retrieved from <http://www.ribaplanofwork.com/>
- Robichaud, L. B., and Anantatmula, V. S. (2010). Greening project management practices for sustainable construction. *Journal of Management in Engineering*, 27(1), 48–57.
- Rodriguez, S. I. (2002). *Sustainability assessment and reporting for the University of Michigan's Ann Arbor*

- Campus*. The University of Michigan. Retrieved from http://css.snre.umich.edu/css_doc/CSS02-04.pdf
- Ruikar, K., Anumba, C. J., and Carrillo, P. M. (2006). VERDICT—An e-readiness assessment application for construction companies. *Automation in Construction*, 15(1), 98–110.
- Schlueter, A., and Thesseling, F. (2009). Building information model based energy/exergy performance assessment in early design stages. *Automation in Construction*, 18(2), 153–163.
- Sharp, H., Finkelstein, A., and Galal, G. (1999). Stakeholder identification in the requirements engineering process. In *Database and Expert Systems Applications, 1999. Proceedings. Tenth International Workshop on* (pp. 387–391). Ieee.
- Sinclair, D. (2013). *Assembling a Collaborative Project Team: Practical tools including Multidisciplinary Schedules of Services*. RIBA Publishing.
- Sinou, M., and Kyvelou, S. (2006). Present and future of building performance assessment tools. *Management of Environmental Quality: An International Journal*, 17(5), 570–586.
- Smith, D. K., and Tardif, M. (2012). *Building information modeling: a strategic implementation guide for architects, engineers, constructors, and real estate asset managers*. John Wiley and Sons.
- Succar, B. (2009). Building information modelling framework: A research and delivery foundation for industry stakeholders. *Automation in Construction*, 18(3), 357–375.
- Succar, B., Sher, W., and Williams, A. (2012). Measuring BIM performance: Five metrics. *Architectural Engineering and Design Management*, 8(2), 120–142. <http://doi.org/10.1080/17452007.2012.659506>
- Svennevig, J. (2001). Abduction as a methodological approach to the study of spoken interaction. *Norskrift*. Retrieved from https://www.researchgate.net/profile/Jan_Svennevig3/publication/251398301_Abduction_as_a_methodological_approach_to_the_study_of_spoken_interaction._Norskrift/links/552798870cf2520617a72415.pdf

- Tudor, R. (2013). *A Practical Guide To Building Thermal Modelling*. www.bsria.co.uk: BSRIA.
- Watts, R. D. (1966). The elements of design. In *The design method*, 85–95. New York City: Springer.
- Welle, B., Haymaker, J., and Rogers, Z. (2011). ThermalOpt: A Methodology for BIM-Based Passive Thermal Multidisciplinary Design Optimization. *Center for Integrated Facility Engineering Technical Report*, (200).
- Wong, K. A., and Fan, Q. (2012). Building Information Modelling (BIM) for Sustainable Building Design. *Facilities*, 31(3/4), 138-158. Retrieved from <http://www.emeraldinsight.com/doi/abs/10.1108/02632771311299412>
- Yang, R. J., Zou, P. X. W., and Keating, B. (2013). Analysing stakeholder-associated risks in green buildings: a social network analysis method. In *WBC 2013: Proceedings of the 19th International CIB World Building Congress* (pp. 1–12). Queensland University of Technology.
- Yin, R. (2013). *Case study research: Design and methods*. Retrieved from <https://books.google.co.uk/books?hl=enandlr=andid=OgyqBAAAQBAJandoi=fndandpg=PT243anddq=yin+case+study+research+fourth+ditionandots=FaJ6m9o30iandsig=bXGm-CAipbDY22pFcSY-nC1c2zY>

Tables

Table 1 Case studies' summary and roles interviewed

No.	Building Project Type(s)	Certification(s)	Sustainability Objectives and Benchmarks	Design Roles Interviewed
CS1	Primary School	BREEAM Excellent, Passivhaus	BREEAM Excellent; 20% of energy use from renewable sources; Passivhaus certification; minimise embodied carbon of materials and systems; minimise energy use and the overheating of spaces; maximise daylight performance; maximise natural ventilation.	Architect, Passivhaus Consultant
CS2	Higher Education	BREEAM Outstanding, Passivhaus	BREEAM Outstanding; Passivhaus certification; specific attention to embodied carbon; minimize the embodied energy and embodied carbon of materials; minimise energy use and lifecycle carbon; maximise daylight maximise natural ventilation; maximise use of timber; test robustness for a 100 years.	Architect, Passivhaus Consultant
CS3	School	Passivhaus	Passivhaus certification; innovation; maximise the use of low impact materials (such as timber cladding); maximise daylight; maximise natural ventilation.	Architect, Sustainability Consultant, BIM Manager
CS4	Public Library	BREEAM Excellent	BREEAM Excellent certification; compliance with English Heritage; functionality; implementation of state of the art heating combined cooling/ heating power system (CCHP); maximisation of daylighting; maximise natural ventilation; retaining the external and internal fabric of the existing building.	Architect
CS5	College	BREEAM Excellent	BREEAM Excellent; 10% renewable energy; 25% uplift on Part L; maximise natural ventilation; minimise embodied energy; selection of category A and B materials.	Architect, Sustainability Consultant
CS6	Hospital	BREEAM Excellent	BREEAM Excellent certification (9 point for energy performance); 40% uplift on Part L; efficient solar shading; maximise airtightness (2 air changes per hour); maximise insulation; minimise environmental impact.	Architect, Sustainability Consultant
CS7	Museum	BEAM Plus	BEAM Plus (a comprehensive environmental assessment scheme widely adopted in Hong Kong, similar to BREEAM and LEED); minimize energy consumption; reduce	BIM Coordinator

No.	Building Project Type(s)	Certification(s)	Sustainability Objectives and Benchmarks	Design Roles Interviewed
			greenhouse gas emissions; Integrated Sustainable Building Design (ISBD).	
CS8	Office	BREEAM Excellent	BREEAM Excellent and A-rated Energy Performance Certificate (score 22); 96% of demolition and 94% of construction waste; renewable technologies for hot water, space heating and cooling.	BIM Manager, BIM Coordinator
CS9	Office	BREEAM Excellent	BREEAM Excellent; maximise daylight and natural ventilation, venting and cooling, passive heating, flexibility, disabled access, and new technology (Solartubes, thermal mass, solar control glass, low energy fitments, gas/biomass boilers, rainwater harvesting, local sensors)	Sustainability Direct, BREEAM Assessor, Architect
CS10	Higher Education	BREEAM Excellent	BREEAM Excellent; daylighting and solar control; power source selection; heating and cooling strategies.	Architect
-	Non-domestic (unspecified case studies)	N/A		Architect, Sustainability Director, Sustainability Engineer, BREEAM Assessor, Energy Modeller, Project Manager

Table 2 Symbols used for process description schematics¹

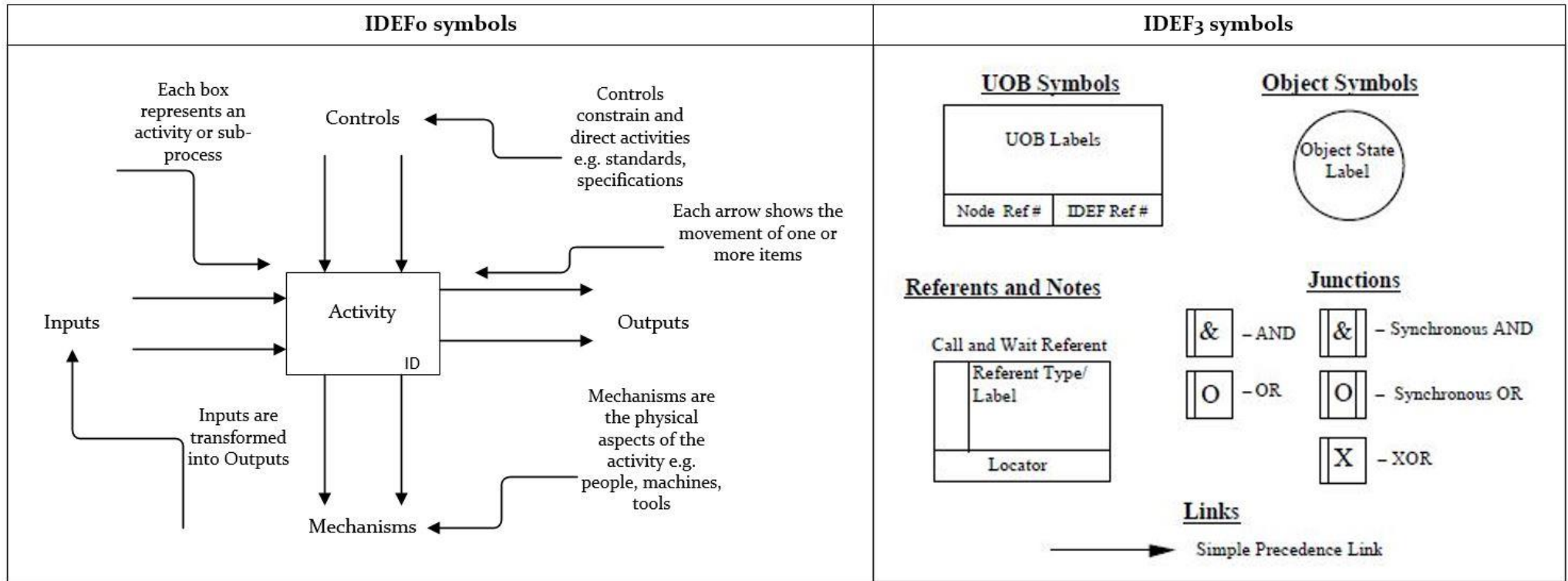

¹ (Knowledge Based Systems Inc. (KBSI), 1993; Mayer et al., 1995)

Table 3 Critical decision points (IDEF3 model Junctions) aligned with sustainability criteria

Decision points	Sustainability criteria
Junction J4	4.1. Overshadowing
	4.2. Building height
Junction J8	8.1. Embodied carbon of materials
	8.2. Toxicity of materials
	8.3. Recycled materials
	8.4. Glazing and shading
	8.5. Daylighting
	8.6. Insulation (U-Values, W/m ² K)
	8.6.1. Wall
	8.6.2. Window
	8.6.3. Roof
	8.6.4. Ground floor
Junction J10	8.7. Airtightness (at 50Pa)
	8.8. Ventilation and cooling
	8.9. Overheating
	8.10 Acoustic performance
	10.1. Energy consumption
	10.1.1. Heating and hot water
	10.1.2. Electrical load
	10.1.3. IT and small power
	10.2. Carbon/CO ₂ emissions
	10.3. Display Energy Certificate (DEC)
Junction 17	10.2. Energy consumption
	10.3. Energy source
	10.4. Artificial lighting
	10.5. Water consumption
	17.1. Controls and metering
Junction 17	17.2. IT strategy
	17.3. Capital cost
	17.4. Lifecycle cost
	17.5. Occupancy and user involvement
	17.6. BREEAM rating
	17.7 Energy Performance Certificate (EPC) score
	17.8 Robustness to climate change

Table 4 IDEF decomposition diagrams

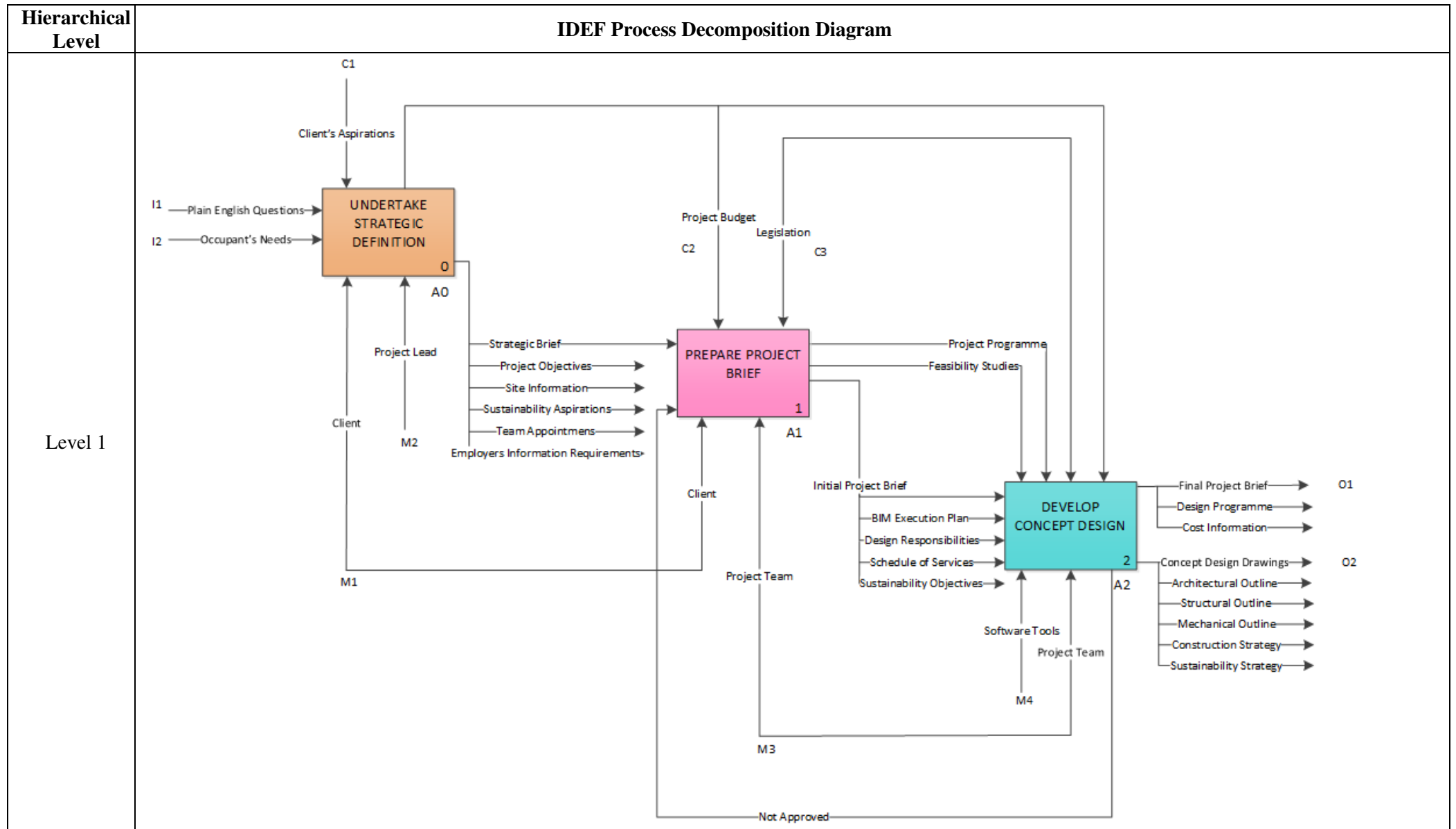

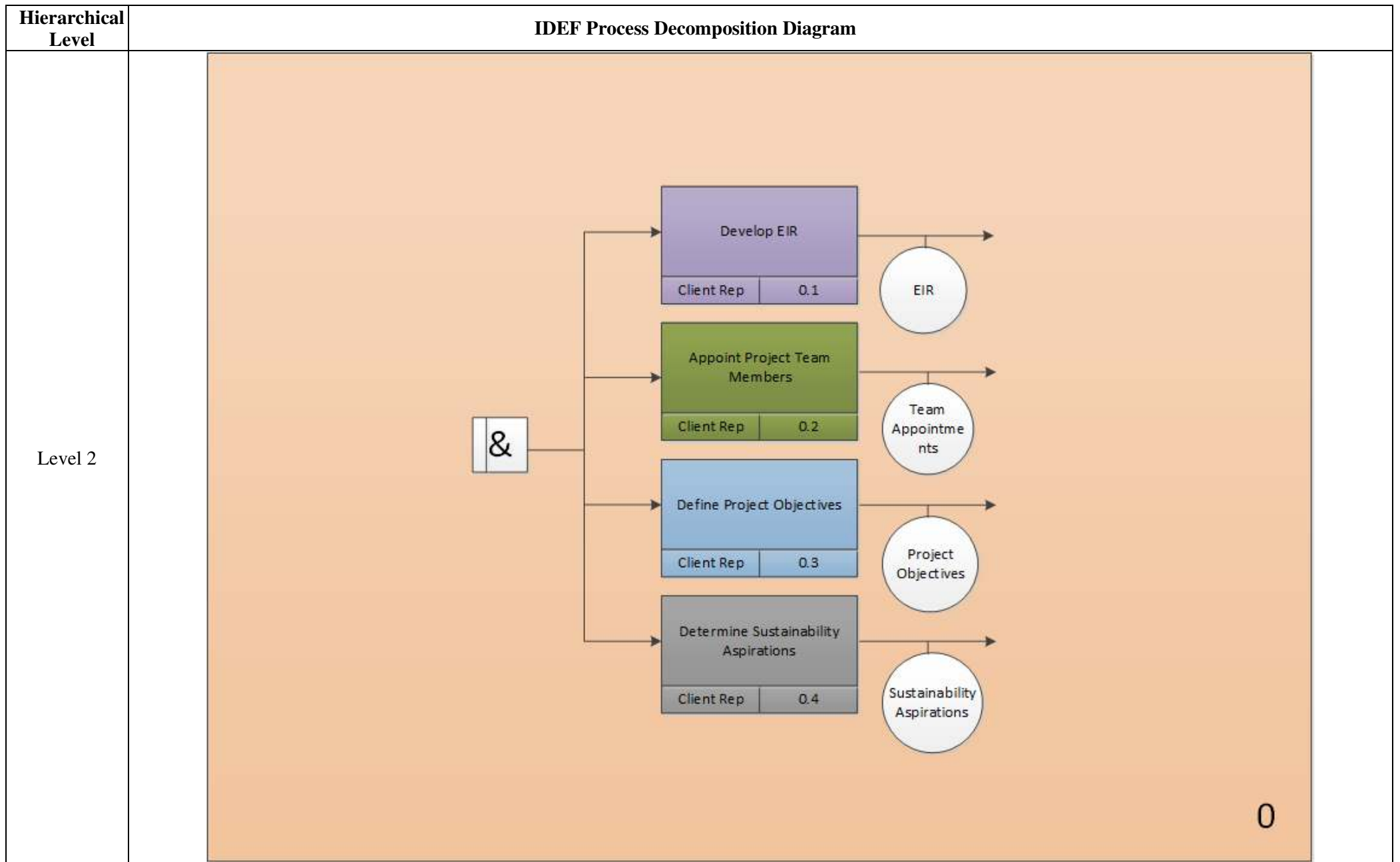

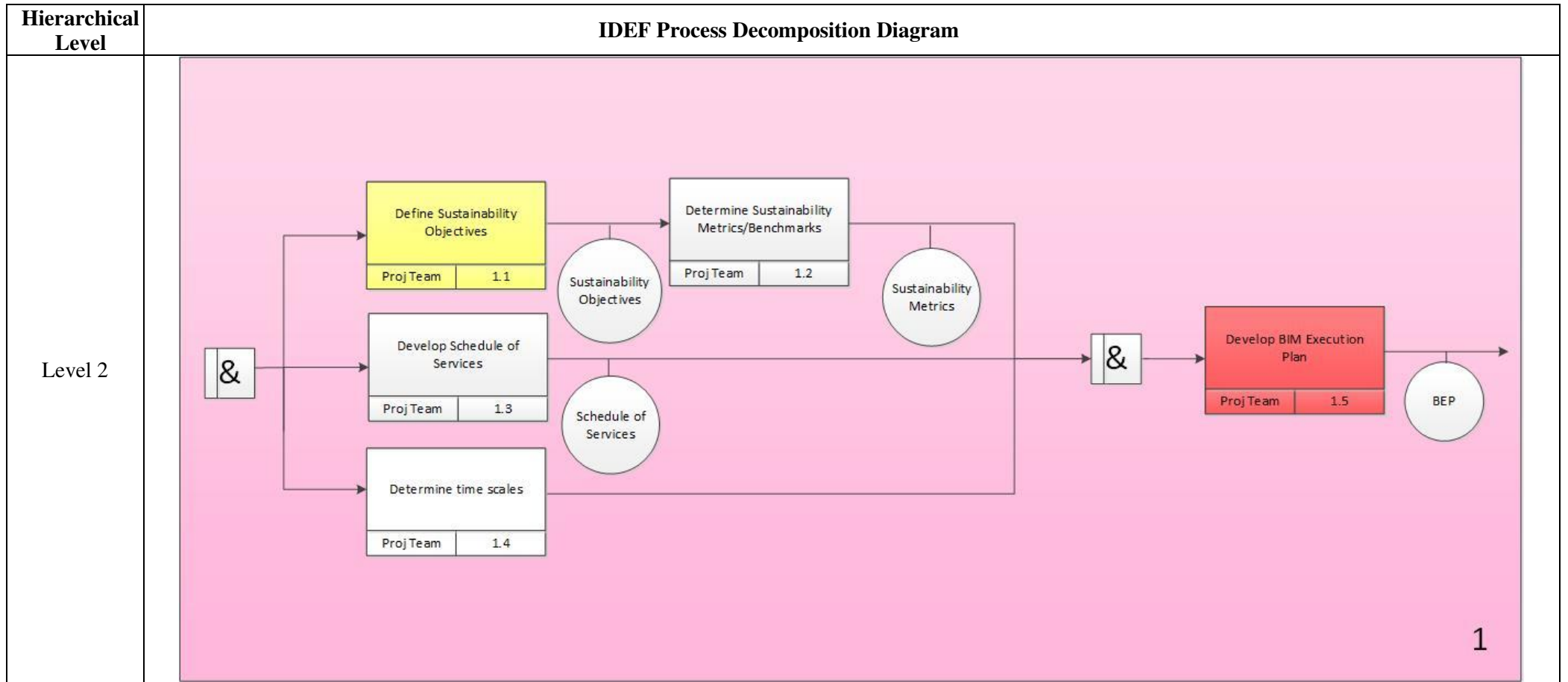

Hierarchical Level

IDEF Process Decomposition Diagram

Level 2

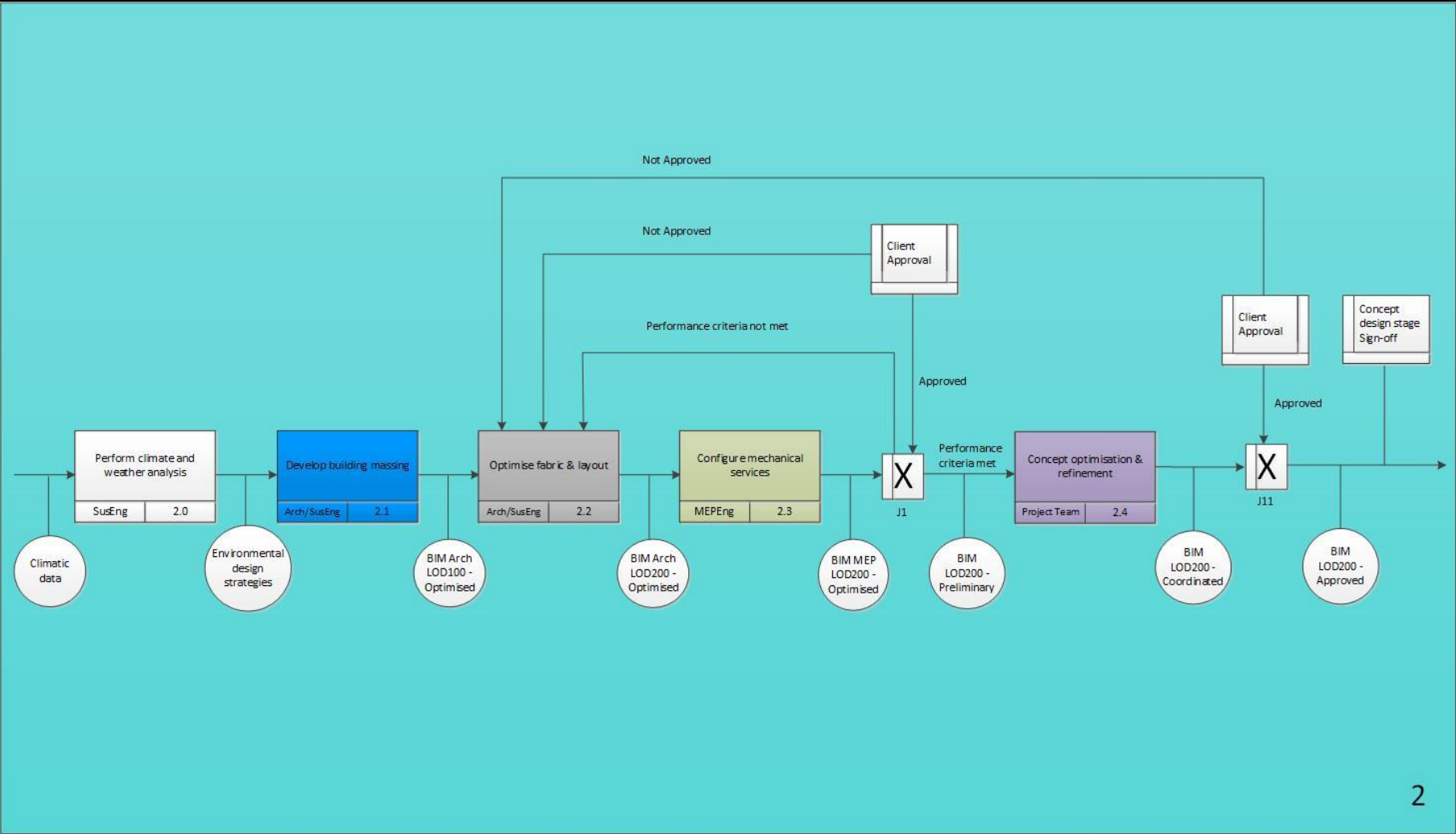

Hierarchical Level

IDEF Process Decomposition Diagram

Level 3

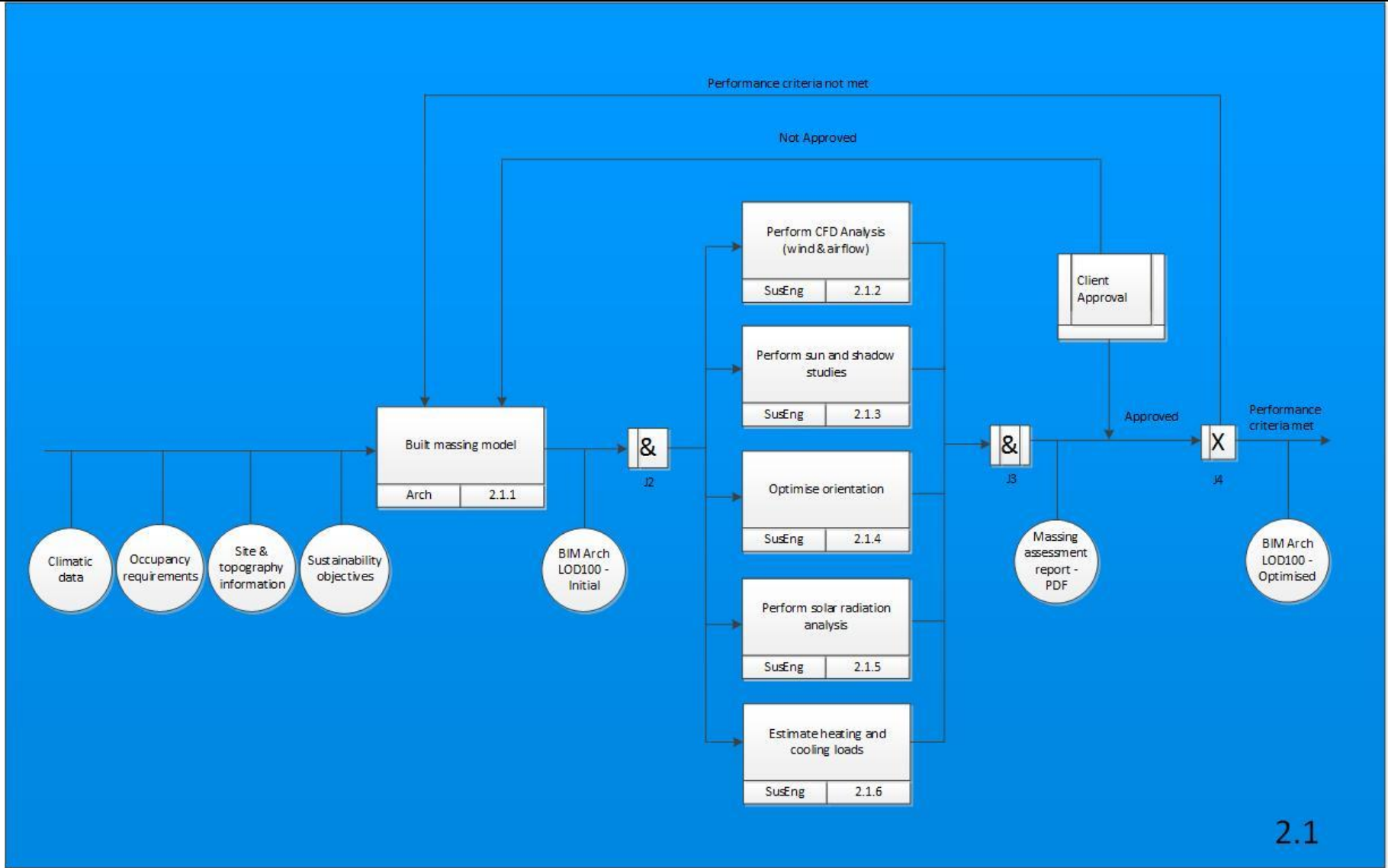

Hierarchical Level

IDEF Process Decomposition Diagram

Level 3

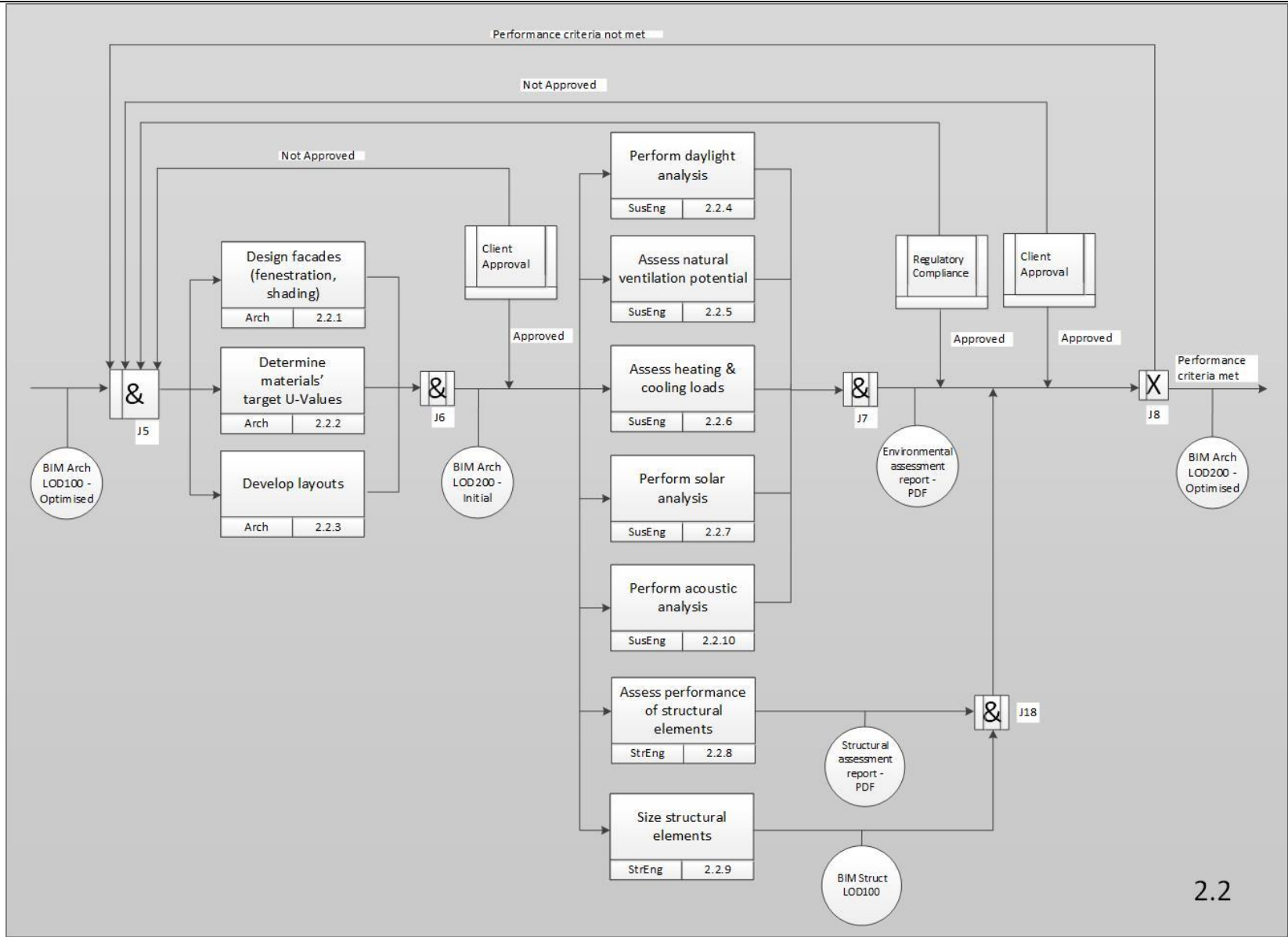

2.2

Hierarchical Level

IDEF Process Decomposition Diagram

Level 3

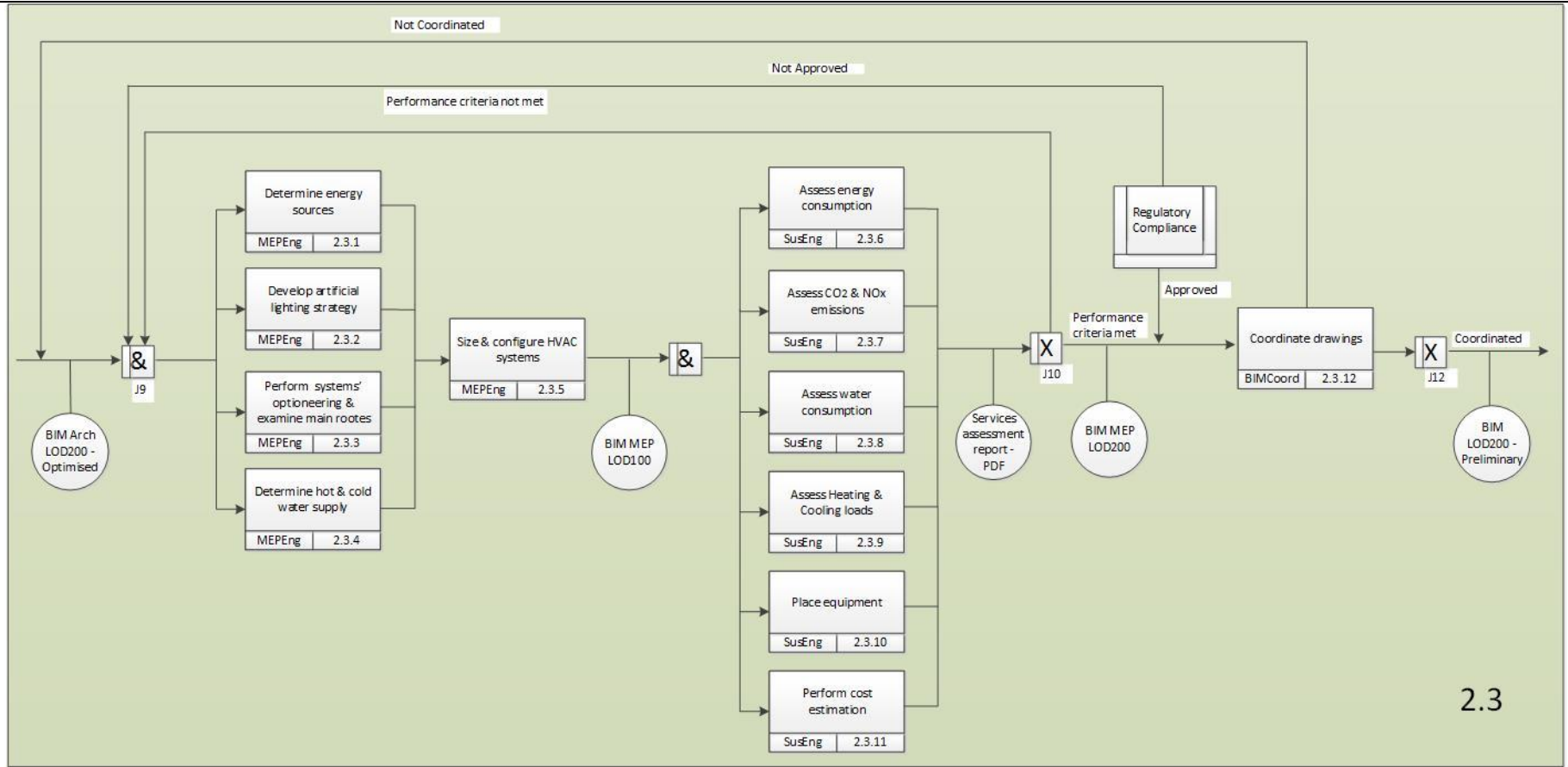

Hierarchical Level

IDEF Process Decomposition Diagram

Level 3

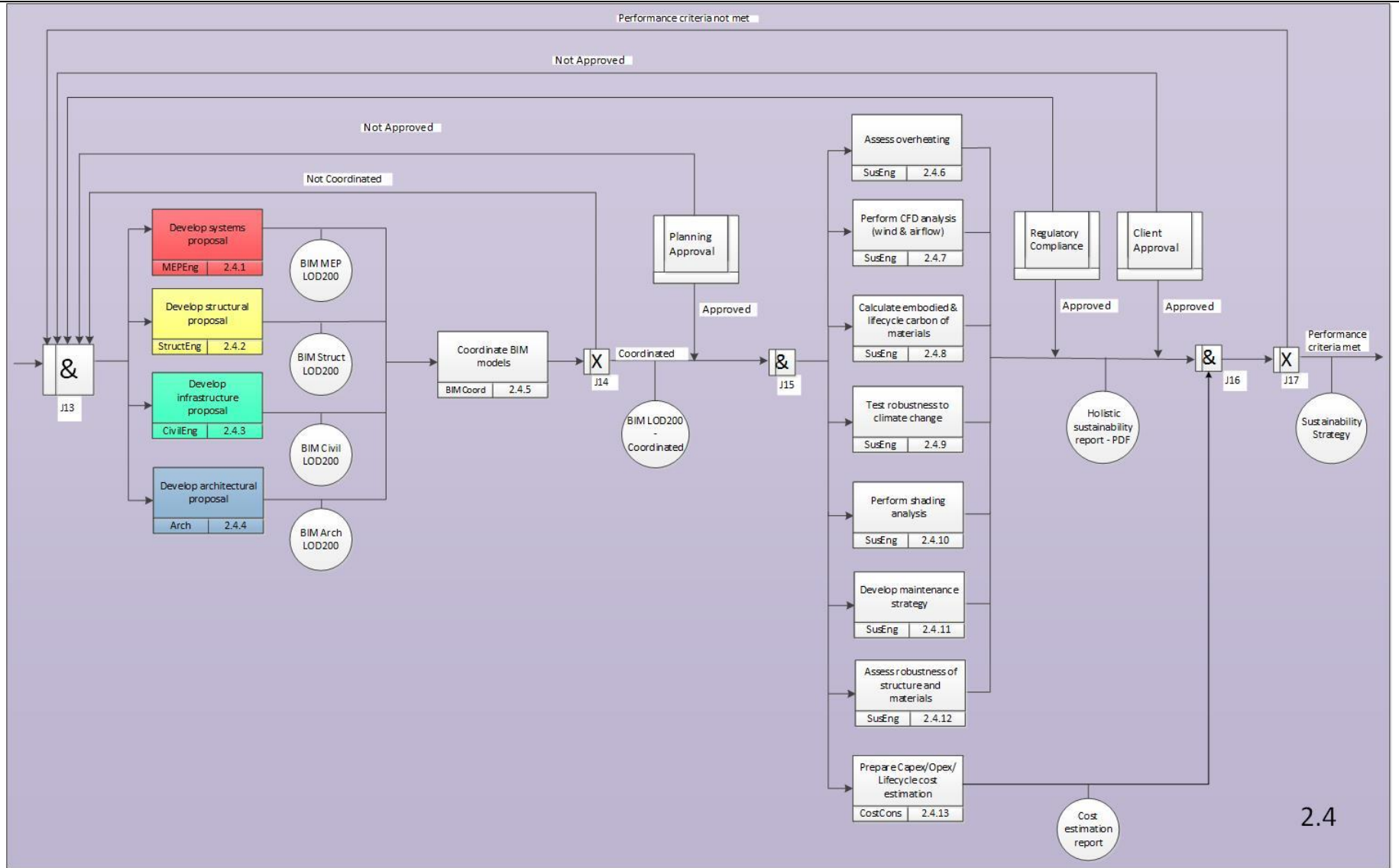

Table 5 Information Requirements of UOBs (Table 4 decomposition diagrams)

Information Requirements (IR)
<p>Level 1 Decomposition</p> <p><u>Inputs of UOB 0</u></p> <ul style="list-style-type: none"> • Plain English Questions • Occupants needs (e.g. comfort and health): activities, functions, number of people, equipment, personal preferences, acoustic requirements, identification of air pollutants (such as nitrogen oxides (NO_x), volatile organic compounds (VOCs), and respirable particulate matter), and water contamination. • Environmental impact: location, topography and surroundings, materials' availability, energy sources, water availability, ecology, risk of flood. • Client satisfaction: UK Level 2 BIM maturity, Government Soft Landings (GSL), Building Regulations (e.g. Part L), certification assessment scheme (e.g. BREEAM, LEED, Passivhaus), budget allowance, timeframe. <p><u>Outputs of UOB 2</u></p> <ul style="list-style-type: none"> • Final Project Brief • Design Programme • Cost Information • Concept Design Drawings • Architectural Outline • Structural Outline • Mechanical Outline • Construction Strategy • Sustainability Strategy
<p>Level 2 Decomposition</p> <p><u>Outputs of UOB 0</u></p> <ul style="list-style-type: none"> • Strategic Brief • Employers Information Requirements (EIR): managerial, commercial, technical • Team Appointments: Architect/Lead Designer, Landscape Architect/Ecologist, MEP engineer, Structural Engineer, Civil engineer, Geotechnical engineer, Transport consultant, Cost consultant, Contractor, Sustainability Lead/Consultant, Sustainability engineer, Energy modeller, Lighting engineer, BREEAM/Passivhaus assessor, Acoustician, Public Health Consultant, BIM manager/Coordinator. • Project Objectives: BREEAM, Passivhaus, Overheating, Construction Design Management, Client approval, Function, Insurance, Building regulations, Planning and Heritage, Lifecycle Cost, Local Sourcing. • Sustainability Aspirations: low embodied carbon and material reuse, energy use and renewable sources, greenhouse gas emissions, daylight performance and efficient solar shading, natural ventilation, robustness to climate change, innovation, functionality and flexibility, disabled access, thermal mass.
<p>Level 2 Decomposition</p> <p><u>Outputs of UOB 1</u></p> <ul style="list-style-type: none"> • BIM Execution Plan: description of the project; project directory; contractual tree; design responsibility matrix and information exchanges; project programme; technology strategy (software, hardware, and training); communication strategy (meetings, types of meetings, queries, data exchanges, format, and transfer mechanisms); common standards; CAD/BIM manual (coordination strategy, standards, coordination, collaborative process, reviews and quality control); and change control procedures. • Schedule of Services • Sustainability Objectives • Sustainability Metrics • Feasibility Studies • Initial Project Brief

Information Requirements (IR)

Level 3 Decomposition

Inputs of UOB 2.0

- Location: latitude
- Orientation: magnetic declination
- Sun angle: clock time azimuth and altitude
- Insolation: direct and diffuse solar radiation (KWh/m²/day), cloud cover, solar radiation diagrams
- Temperature: average minimum, average maximum per month
- Rainfall / precipitation: per month
- Relative Humidity: per cent (based on dew point)
- Wind analysis: speed (m/s), temperature, direction and frequency for each month or season

Outputs of UOB 2.0

- Psychrometric Chart illustrating comfort zones
- Design Guidelines of passive design strategies

Level 3 Decomposition

Inputs of UOBs 2.1.1 – 2.1.6

- Schedule: number of people, days of occupancy per month, hours a day of occupancy, type of activity per room
- Heat analysis: comfort zone (air temperature, air velocity, humidity) mean radiant temperature, heat balance model, comfort equations, adaptive theory principle
- Climate data: sun angle, temperature, diffuse and direct solar radiation, rainfall, humidity, wind speed, temperature and direction

Outputs of UOB 2.1.1/ Inputs of UOBs 2.1.2 – 2.1.6

- Massing: rotation of orientation and analysis of building forms
- Properties: insulation (R-Value, U-Value)

Outputs of UOBs 2.1.2-2.1.6

- Cast shadows for selected hour ranges at specific days of the year (typically solstices and equinoxes)
- Diagram of heating and cooling loads for building rotations (0 to 90 degrees)
- Insolation values (KWh/m²/day) on selected planes (e.g. walls, roofs, site)
- Heating and cooling loads: kWh/m²

Level 3 Decomposition

Outputs of UOBs 2.2.1 – 2.2.3

- Climate data: sun angle, temperature, diffuse and direct solar radiation, rainfall, humidity, wind speed, temperature and direction
- Site analysis: site elements and qualities, topography, surroundings (e.g. masses, materials)
- Schedule: number of people, days of occupancy per month, hours a day of occupancy, type of activity per room
- Heat analysis: comfort zone (air temperature, air velocity, humidity) mean radiant temperature, heat balance model, comfort equations, adaptive theory principle
- Sound: decibel (dB) levels and quality vary per room requirements, environmental noise prevention and elimination
- Massing: rotation of orientation and analysis of building forms
- Materials: embodied energy, thermal properties, glazing properties, reflection values, lifecycle carbon analysis
- Elements' properties (walls, ceilings, floors, roofs, partitions): insulation (R-Value, U-Value), thermal lag (hours), solar absorption (0-1), colour reflection (0-1), emissivity
- Glazing: size, location, shape, U-Value, SHGC (Solar Heat Gain Coefficient), VLT (Visual Light Transmittance), LSG (Light to Solar Gain Ratio), shading coefficient (0-1), transparency, emissivity, colour reflection

Outputs of UOB 2.2.4-2.2.9

- Daylighting analysis: DF (Daylight Factor) percentage, overshadowing, (DA) Daylight Autonomy (lux), colour temperature, solar shading control or illuminance pattern, glare, visibility, reflections
- Natural ventilation: CFD (Computational Fluid Dynamics) analysis, mean wind velocity (m/s), atmospheric boundary layer (height), turbulence, infiltration, indoor air quality

Information Requirements (IR)

- Heating hours, heating and Cooling loads: (KWh/m²)
- Insolation values (KWh/m²/day) on selected planes (e.g. walls, roofs, site), overheating, passive solar heat, solar radiation
- Structural analysis: frame sizing, windows and doors bracings, embodied carbon and thermal mass/lag(hours) of structural materials
- Sound analysis: (wave analysis initial time delay gap (ITDG), reverberation time, Early decay time (EDT), sound rays distribution)

Level 3 Decomposition

Outputs of UOB 2.3.1 – 2.3.4

- Geometry: plant/s location and sizing, ducts' location and routes
- Renewable systems: average daily output, energy losses
- Lighting: (CCT) correlated colour temperature(K), colour rendering, colour constancy, uniformity, diversity, luminous efficacy, luminaire, lamps (photometrics), Part L (W/m² per 100 lux loads), controls, lumen calculation
- Heating and cooling: HVAC (heating, ventilation, and air conditioning), convection heat, radiant heat, radiant cooling, convection cooling, exergy, heat pumps, electric heating, Gas/oil/LPG fired indirect systems (boilers), Combined Heat and Power (CHP), Coefficient of Performance (COP), latent loads
- Ventilation: mechanical or hybrid, volumetric flow, mass flow, fresh air ventilation requirement, ventilation rate, air quality, energy recovery, air filtration, ventilation effectiveness (ve)
- Water: Domestic Hot Water (DHW), hot and cold water(l/person), resistance flow, pumps, sterilisation, water harvesting, efficient equipment, greywater reuse, onsite water treatment, schedules, commission, operation and maintenance

Outputs of UOB 2.3.6 – 2.3.11

- Energy consumption (Wh/m²/yr) for heating, cold water, electrical load, IT and small power
- Carbon emissions (CO₂/m²/yr)
- Part L compliance (2013, 2016, 2019), Display Energy Certificate (DEC) rating (A, B, C, D)
- Water consumption (m³/person/yr)

Outputs of UOB 2.3.12

- Coordinated BIM LOD200 model and information requirements

Level 3 Decomposition

Inputs of 2.4

UOB's 2.3 Outputs

Outputs of UOB 2.4.13

- Capital expenditures (Capex): overall construction, material cost, components cost
- Operating expenses (Opex): operational cost, energy cost, energy savings
- Lifecycle cost: Standardised Method of Life Cycle Costing (RICS)

Table 6 Roles and responsibilities for sustainable building design

- Client/Client Adviser: Selection of site; commissioning; consultation with stakeholders; possibility of shared facilities; security; proximity to amenities and public transport; responsible sourcing of materials; maximum car parking efficiency; energy efficient equipment.
- Architect/Lead Designer: Site investigation; shared facilities; security; amenities; recyclable waste; daylight; view out; glare control; building fabric performance and infiltration; material specification; re-use of building fabric and structure; responsible sourcing of materials; insulation; daylighting; hard landscaping.
- Landscape Architect/Ecologist: Site investigation; ecological value protection; re-use of land; enhancing ecology; outdoor space; hard landscaping, and boundary protection.
- MEP Engineer: Site investigation; community energy supply; low and zero carbon technologies; daylighting; internal and external lighting levels; lighting zones and controls; potential for natural ventilation; indoor air quality; thermal comfort; thermal zoning; reduction of CO₂ (carbon dioxide) emissions; building fabric performance and infiltration; free cooling; water consumption; NO_x (nitric oxide and nitrogen dioxide) emissions.
- Structural Engineer: Site investigation; re-use of building façade and structure; recycled aggregates.
- Civil Engineer: Site investigation; water management; irrigation systems; flood risk.
- Geotechnical Engineer: Site investigation; re-use of land; contaminated land.
- Transport consultant: Site investigation; provision of public transport; travel plan; maximum car park capacity.
- Cost Consultant: Capex (capital expenditure); Opex (operational expenditure); Lifecycle cost assessment.
- Contractor: Site investigation; construction site impacts; CCS (considerate contractors) compliance; construction site waste management; construction waste management.
- Sustainability Lead/Consultant: Site investigation; sustainability briefing; client consultation; developing schemes for the potential building; coordinating different stakeholders; providing advice regarding material specifications, saving water and energy; social and environmental impact.
- Sustainability Engineer/Energy Modeller: Energy performance of a building; modelling buildings using thermal models, detailed simulation tools [e.g. CFD (Computational fluid dynamics)], detailed lighting; environmental impact.

- Lighting Engineer: daylight analysis assessment; design and implementation of artificial lighting arrangements.
- BREEAM/Passivhaus Assessor: Client consultation; follow the BREEAM/Passivhaus routes, planning statements; coordinating different stakeholders; assess evidence from the design team; providing advice; getting the certificate.
- Acoustician: Site investigation; noise attenuation; inside acoustic performance.
- Public Health Consultant: Site investigation; flood risk; water recycling; irrigation systems; watercourse pollution.
- BIM Manager/Coordinator: Develop BIM strategy; assist the team with software selection and interoperability; determine information exchanges; develop BEP; coordinate BIM models and information (4D, 5D); review model and detect clashes; report clashes; resolve areas of uncertainty in the model; general overview that the BEP is followed as planned.

Table 7 Delivery of information during stage 2 (concept design)

<i>UOB</i>	<i>WHY</i>	<i>WHO</i>	<i>WHAT</i>	<i>HOW</i>
<i>Perform climate and weather analysis (UOB 2.0)</i>	Climatic conditions are critical for building performance analysis. Analysing the local climate results in identifying the appropriate design strategies that can be implemented for a specific location.	This role needs to have the ability to understand weather data diagrams (e.g. temperature, humidity, solar radiation, wind roses) and interpret the results presented in a psychrometric chart (comfort zones) to determine the most appropriate design strategies for the site. This task is undertaken by the Sustainability Engineer, or the Sustainability Consultant.	Weather data comes from physical weather stations, which are situated at large airports and are less accurate. Such weather files can be downloaded from the US Department of Energy (DOE). Data that are more accurate can be generated by Meteonorm software, which combines data from various weather stations that surround the site. The output of this analysis is the passive design strategies (Design Guidelines) that can be implemented to extend the comfort zones within the building.	Open-source software is available for this purpose (e.g. Climate Consultant). Furthermore, several BPA software offers these capabilities such as IES VE, Sefaira, and EcoDesigner. The user imports the Climate Data file in the software, selects the Comfort Zone model of their preference (e.g. ASHRAE Standard 55 and Current Handbook of Fundamentals Model, ASHRAE Handbook of Fundamentals Comfort Model up through 2005, Adaptive Comfort Model in ASHRAE Standard 55-2010), and the Passive Design Strategies that are to be examined.
<i>Develop building massing (UOB 2.1)</i>	Massing of the building is deciding the size and shape (e.g. height, footprint). The target is to minimise energy requirements by reducing the heating and cooling loads required while maximising passive cooling (natural ventilation), passive heating (direct solar radiation), and daylight (diffuse solar radiation). The shape, orientation, and location of the building on site are the critical decisions of this task. Sun and shadow studies (UOB 2.1.3) reveal the availability of daylight for and the impact of topography and surrounding buildings the Right to Light Act (1959) needs to be considered. The building height needs to cause minimal disruption to the surrounding buildings and comply with the Local Authorities requirements (UOB 2.1.1). Solar radiation analysis (UOB 2.1.5) determines the availability of sun beams that can be utilised for passive heating strategies and renewable energy generation (e.g. photovoltaics).	This responsibility is undertaken by the Architect, who is responsible for the design development. In order to perform this task, they need to have an understanding of the sustainability principles (e.g. heuristics, rules of thumb) so as to potentially achieve fewer iterations. Manipulation of 3D authoring tools and the ability to interpret the environmental analysis results is also required. An in-house Sustainability specialist could perform the BPA at this stage. If such a specialist is not a part of the architectural design team, they would need to work closely with a Sustainability Consultant or a Sustainability Engineer who can provide advice.	The climate data, occupancy schedule and comfort levels, site location and topography, and the sustainability metrics need to be available before initiating building the massing model. In the case of an informed Architect, the output is an optimised building mass 3D model. If a Sustainability Engineer is required, PDF reports are provided to the Architect until both parties, and the Client reach an agreement (J4).	Building massing can be done in Revit, ArchiCAD, Rhino or SketchUp. Revit software has built-in capabilities for performing UOBs 2.12 to 2.1.5. A knowledgeable Architect can utilise these tools to make informed decisions regarding the building massing. Furthermore, Sefaira software's plug-ins can be utilised with Revit or SketchUp. If a Sustainability Engineer is required, the analysis can take place in IES VE software, which also provides more accuracy. The optimisation of the building's orientation (UOB 2.1.4) is achieved by rotating the building axis from 0 to 90 degrees and simulating the heating and cooling loads that are achieved for each orientation. This technique is part of the Sensitivity Analysis method described in Ternoey et al. (1985). The final optimised BIM Arch model (LOD100) is issued in the CDE (e.g. 4Projects, BIW by Conject, aconex, BOX). The preliminary outline design needs to be approved by the Client before the decisions are frozen. If the Client does not approve the proposal, the process iterates to UOB 2.1.1.

<i>UOB</i>	<i>WHY</i>	<i>WHO</i>	<i>WHAT</i>	<i>HOW</i>
<i>Optimise fabric and layout (UOB 2.2)</i>	The targets at this stage are to optimise the fabric performance by utilising passive design strategies (e.g. daylight autonomy, solar gains, natural ventilation, thermal mass effects and night cooling). This would result in minimising energy requirements and promoting human comfort and health inside the building.	The Architect, who is responsible for authoring the BIM model (LOD200), should have the ability to manipulate a 3D model, along with the experience in construction methods and means. The Sustainability Engineer role must have the ability to navigate, manipulate and review a 3D BIM model. Furthermore, they need to have a good knowledge of environmental design principles, material properties and specifications, and building regulations regarding the sustainability measures' implementation. The Structural Engineer sizes the structural elements and assesses their performance.	Table 5 contains the information requirements to perform the tasks of UOB 2.2. The first row shows the information that should be contained at the BIM Arch LOD200 model submitted to the Sustainability Engineer for analysis. The outputs of the performance analysis (rows 2-6), should be interpreted and explained in a PDF report or PowerPoint presentation that contain recommendations and advice for the design team. The outputs of the structural analysis are a BIM Struct LOD200 model and a report.	The Architect must utilise a BIM authoring tool such as Revit, ArchiCAD, or Microstation to develop the BIM LOD200 model containing the fabric information. The model should be uploaded in the CDE in an IFC or gbXML format. Each space/room must be designed as a single thermal zone that contains the occupancy requirements and the properties of its elements. If there is an in-house Sustainability specialist, tools such as Sefaira and EcoDesigner offer reliable results, although not accredited. For accurate results, which comply with the building regulations, an accredited software package such as IES VE, Hevacomp, TAS, and DesignBuilder must be utilised. The Sustainability Engineer should upload the performance analysis report in the CDE. The Structural Engineer utilises Revit for early structural design and analysis. When the design solution is approved by the Client, the Architect, Structural and the Sustainability Engineer, the BIM Arch LOD200 model is optimised and the design can progress to the next stage.

UOB	WHY	WHO	WHAT	HOW
<p><i>Configure mechanical services (UOB 2.3)</i></p>	<p>The sustainability intent at this stage is to the selection of efficient services that require the minimal amount of energy, while delivering the heating and cooling loads required. Furthermore, the use of clean energy sources from renewables (e.g. sun, wind) is preferred to conventional sources (e.g. petrol). The sizing of the plant rooms, ducts, and their routes are important considerations at this stage. Compliance with Part L of the Building Regulations is a mandatory requirement.</p>	<p>The MEP Engineer is authoring the services model, identifying the size and location of the plant rooms and the duct sizes and routes within the building. The ability to manipulate, review and author 3D BIM models is needed. The Sustainability Engineer should be able to review the 3D BIM model, author a 3D model in dynamic simulation software (e.g. IES VE, Hevacomp, TAS), perform the analysis, and interpret the results. The BIM coordinator should be able to manipulate 3D models and identify the constructability of the design. Good knowledge of building systems is required to identify the clashes and resolve the issues.</p>	<p>The outputs of UOB 2.2 (Table 5) are required for performing UOB 2.3.1 to 2.3.4. To determine the energy sources (UOB 2.3.1), site information analysis is required regarding their availability on or close to the site. To develop the artificial lighting strategy (UOB 2.3.2), the daylight autonomy needs to be determined first (2.2.4). The target illuminance levels, lighting zones of artificial lighting, their controls, and the selection of lamps are the outcomes of UOB 2.3.2. (CIBSE Guide L and CIBSE Guide SLL). The sizing of HVAC systems responds to the heating and cooling loads, identified in UOB 2.2.6 (CIBSE Guide B). The outputs of UOB 2.3.5 are identifying the location of the plant room/s, estimating the sizing and routes of ductwork. The selection of efficient HVAC equipment is the main consideration of UOB 2.3.1 to 2.3.5 (CIBSE Guide F). The thermal loads/heat gains as well as the energy consumption of IT, small equipment, and lighting should be assessed explicitly in order to make realistic estimations. Water systems strategies (e.g. water harvesting, water recycling) need to be considered at this stage (UOB 2.3.4). Table 5 shows the information requirements for UOB 2.3 tasks. It is recommended not to oversize the plant due to peak heating and cooling loads. Localised solutions may be implemented instead for specific times, when required. The BIM Arch, Struct, and MEP LOD200 models are required to perform the coordination exercise (UOB 2.3.12). The output of UOB 2.3.12 is a coordinated BIM LOD200 model with the information attached.</p>	<p>The MEP Engineers utilises Revit, AECOSim, CAD Duct, or other 3D authoring tools to create the BIM LOD200 model (UOB 2.3.1-2.3.4). The functions of UOB 2.3.6, 2.3.8, and 2.3.9 may occur concurrently in Revit utilising the cloud-based facility for early design calculations. For more accuracy, UOB 2.3.6 to 2.3.11 can be assessed in IES VE software. The BIM MEP LOD200 model, along with the analysis report are uploaded in the CDE. The coordination of the Arch, Struct, and MEP BIM models requires the use of coordination software tools such as Navisworks and Solibri. The former is considered simpler in use, while the latter offers extended capabilities.</p>

<i>UOB</i>	<i>WHY</i>	<i>WHO</i>	<i>WHAT</i>	<i>HOW</i>
<i>Develop holistic concept (UOB 2.4)</i>	The optimisation of concept design occurs by assessing the trade-offs of design solutions while assessing the implications on environmental performance and cost.	The Client, Architect, MEP Engineer, Structural Engineer, Sustainability Engineer, and Cost Consultant/Contractor work collectively in a holistic iterative process.	The information requirements of Table 5 are manipulated to reach LOD200. The outcome of the UOB 2.4 is a Federated Model consisting of component models (Arch, Struct, MEP), drawings derived from the models, and data sources. A cost estimation report (Table 5), and a BREEAM design stage pre-assessment (J17) are also required.	An iterative process of developing, analysing/assessing, and reviewing the individual proposals until a consensus is reached between the project team members. The working methods for UOB 2.4.1 to 2.4.5 resemble the ones of UOB 2.1 to 2.3. For assessing UOB 2.4.6 - 2.4.12, dynamic simulation analysis is required for accurate results before freezing the design solutions. For that purpose, accredited simulation software (e.g. IES VE, TAS, Hevacomp, and DesignBuilder) should be utilised before committing to decisions. Revit performs early cost analysis but dynamic cost modelling in Excel or specialised software is recommended (e.g. TurboBid Estimating, HCSS HeavyBid, Viewpoint MEP Estimating, B2W Estimate - Estimating and Bidding, ProContractor™ by Viewpoint). The documents for BREEAM pre-assessment are uploaded in Tracker Plus or IES TaP.

Figures

Figure 1 Overview of the research design

Figure 2 BIM-enabled SBD process framework

Figure 3 Interoperability between BIM Authoring tools and Dynamic Simulation Accredited Software

Figure 4 Sustainability considerations aligned with the RIBA Plan of Work 2013

Figure 5 IDEF process model master-map showing hierarchical relationships between processes and sub-processes (see Table 4 for detailed decompositions)

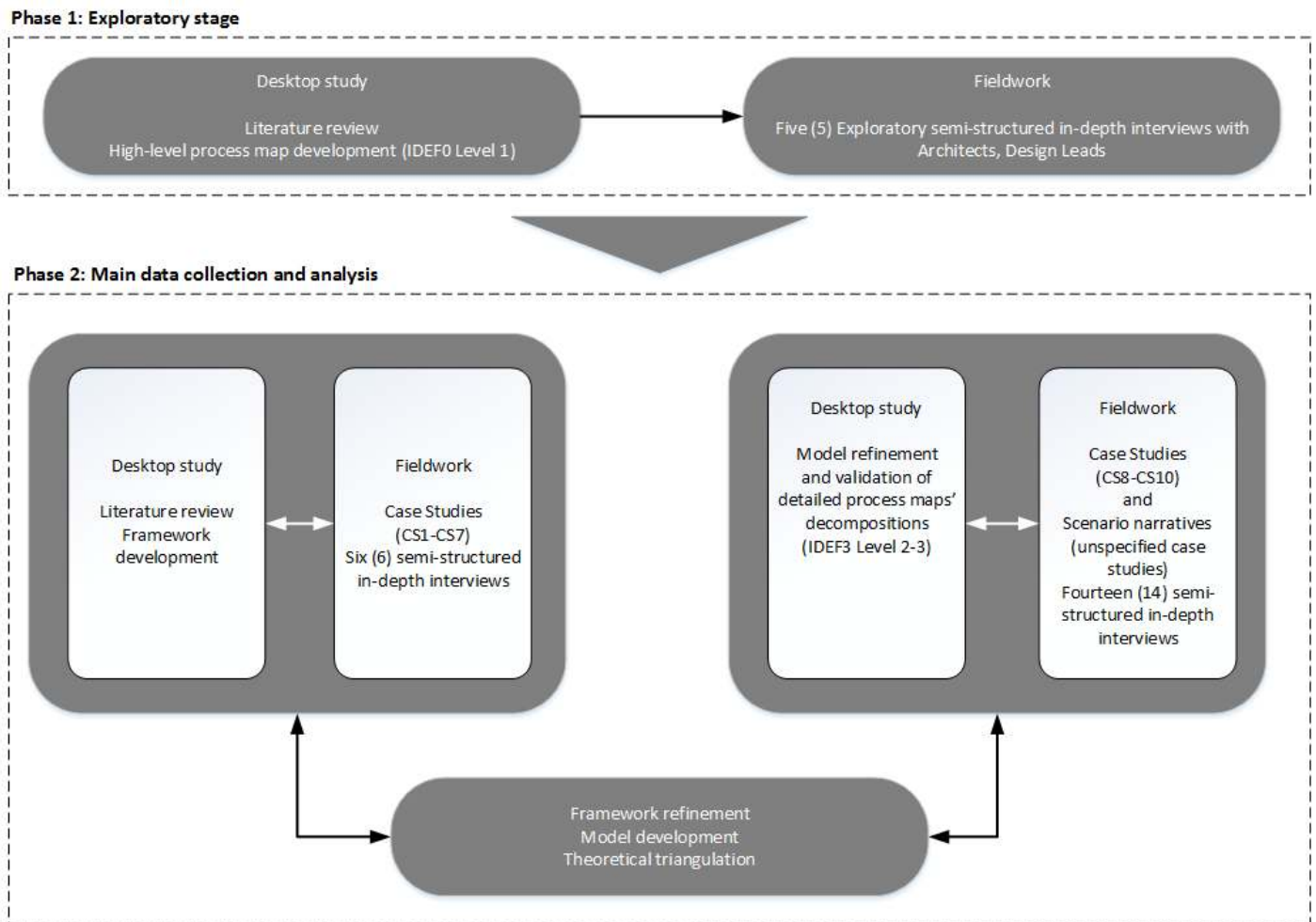

Figure 1 Overview of the research design

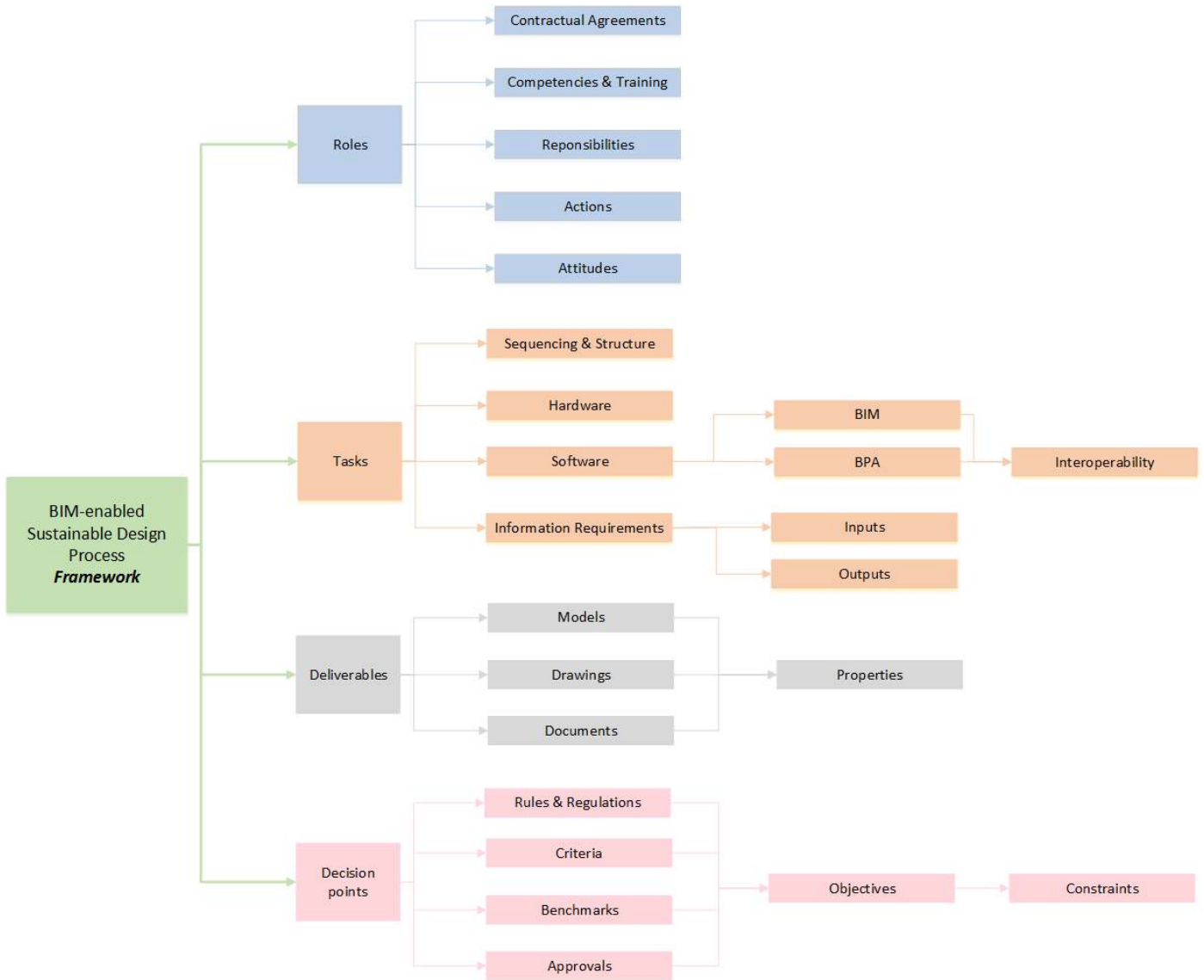

Figure 2 BIM-enabled SBD process framework

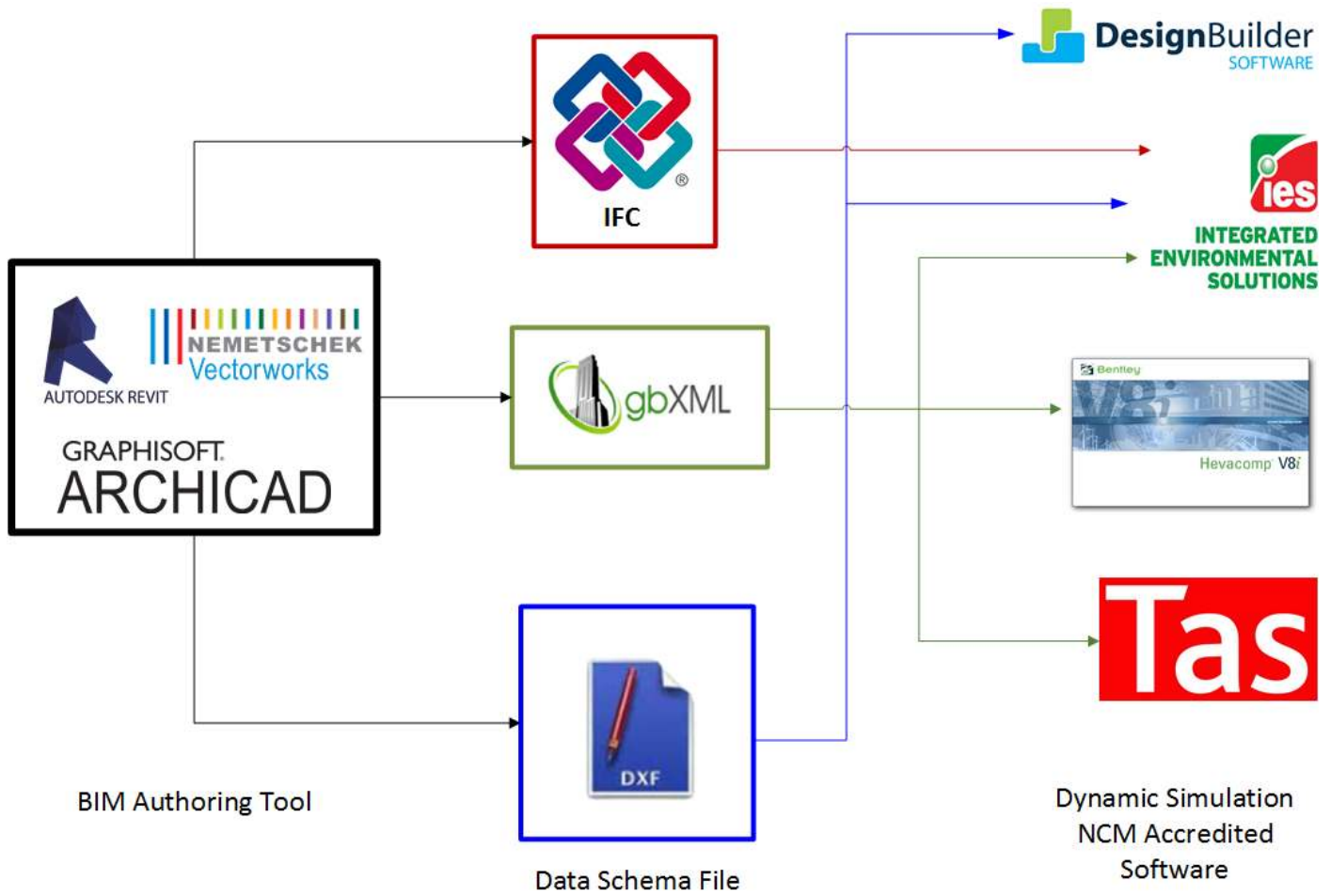

Figure 3 Interoperability between BIM Authoring tools and Dynamic Simulation Accredited Software

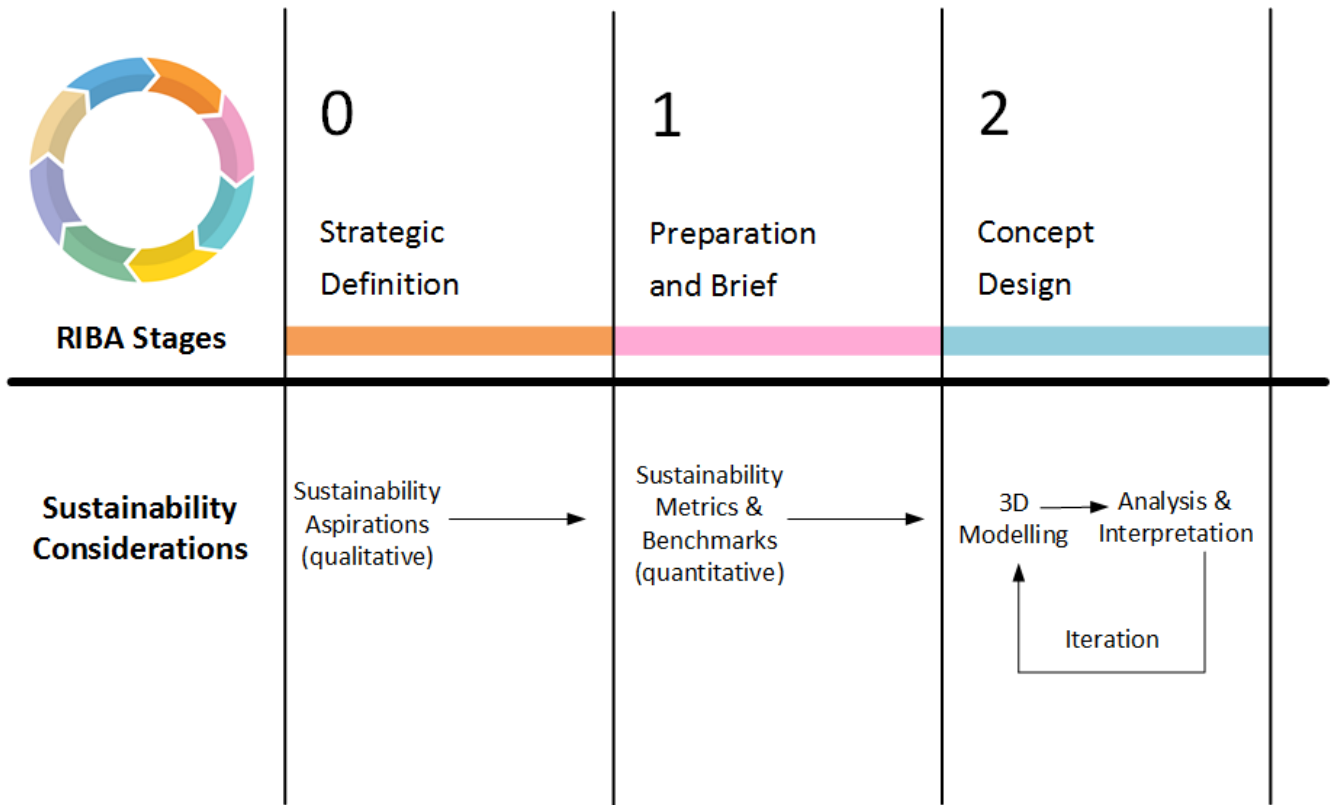

Figure 4 Sustainability considerations aligned with the RIBA Plan of Work 2013

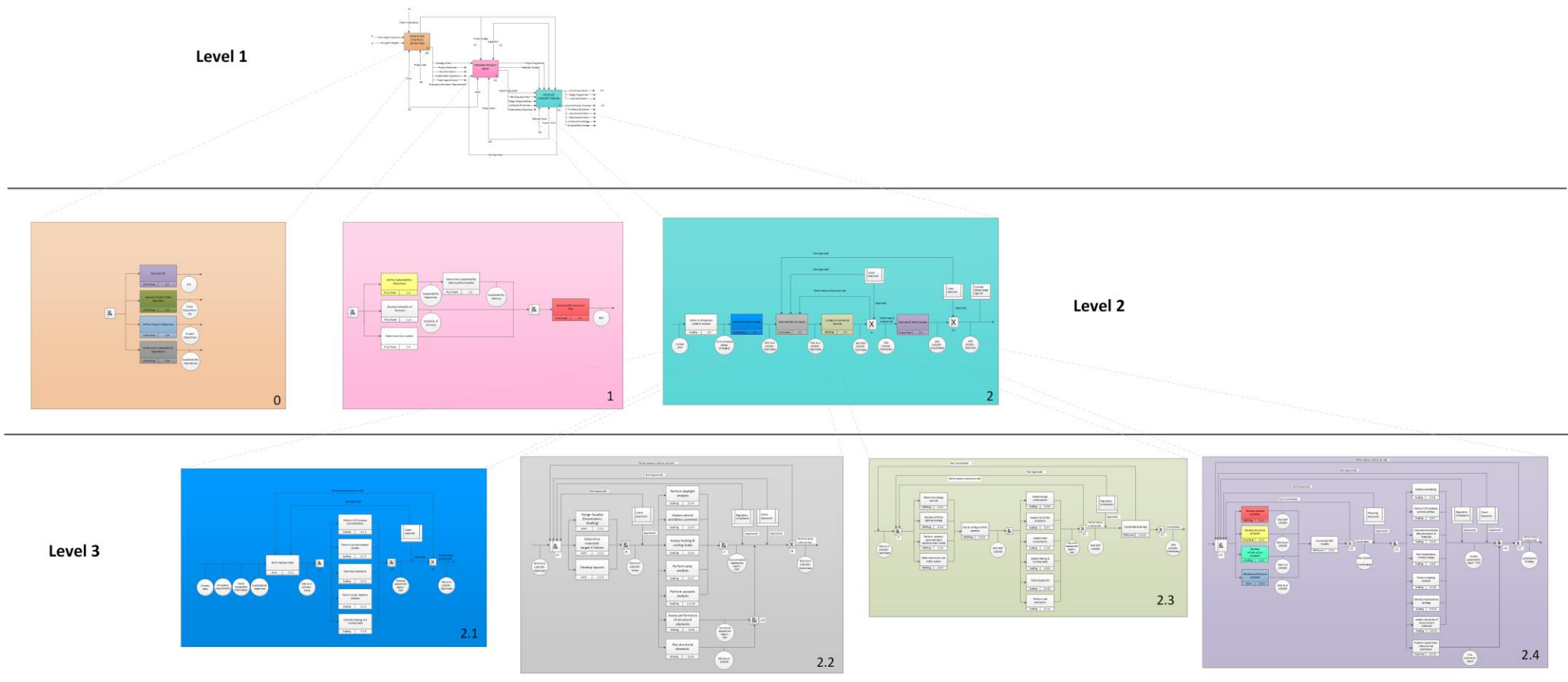

Figure 5 IDEF process model master-map showing hierarchical relationships between processes and sub-processes (see Table 4 for detailed decompositions)