

AD-A181 349

TRAFFIC ALERT AND COLLISION AVOIDANCE SYSTEM (TCAS)
SURVEILLANCE PERFORMANCE (U) MASSACHUSETTS INST OF TECH
LEXINGTON LINCOLN LAB W H HARMAN ET AL 08 MAY 87

1/2

UNCLASSIFIED

ATC-135 DOT/FAA/PH-85/29 DOT-FA77WAI-817

F/G 1/4

NL

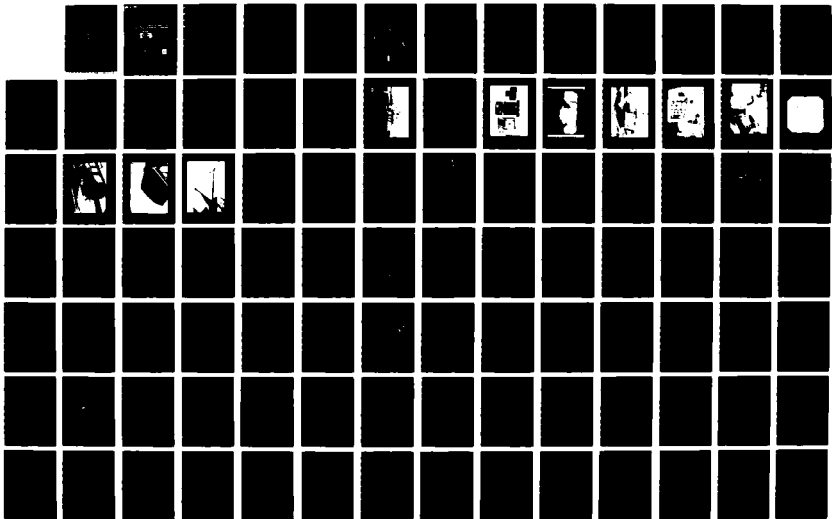

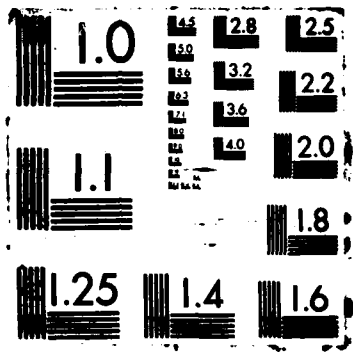

AD-A181 349

2

Project Report
ATC-135

Traffic Alert and Collision Avoidance System (TCAS) Surveillance Performance in Helicopters

DTIC
ELECTE
JUN 1 5 1987
S D
D A

W.H. Harman
J.D. Walsh
M.L. Wood

8 May 1987

Lincoln Laboratory

MASSACHUSETTS INSTITUTE OF TECHNOLOGY

LEXINGTON, MASSACHUSETTS



Prepared for the Federal Aviation Administration.

Document is available to the public through
the National Technical Information Service,
Springfield, Virginia 22161.

DISTRIBUTION STATEMENT A
Approved for public release
Distribution Unlimited

87 6 12 133

This document is disseminated under the sponsorship
of the Department of Transportation in the interest of
information exchange. The United States Government
assumes no liability for its contents or use thereof.

1. Report No. DOT/FAA/PM-85/29		2. Government Accession No. <i>AD-A181-349</i>		3. Recipient's Catalog No.	
4. Title and Subtitle Traffic Alert and Collision Avoidance System (TCAS) Surveillance Performance in Helicopters				5. Report Date 8 May 1987	
				6. Performing Organization Code	
7. Author(s) William H. Harman, III, Jerry D. Welch, and M. Loren Wood, Jr.				8. Performing Organization Report No. ATC-135	
9. Performing Organization Name and Address Lincoln Laboratory, MIT P.O. Box 73 Lexington, MA 02173-0073				10. Work Unit No. (TRAB)	
				11. Contract or Grant No. DOT-FA77WAI-817	
12. Sponsoring Agency Name and Address Department of Transportation Federal Aviation Administration Systems Research and Development Service Washington, DC 20591				13. Type of Report and Period Covered Project Report	
				14. Sponsoring Agency Code	
15. Supplementary Notes The work reported in this document was performed at Lincoln Laboratory, a center for research operated by Massachusetts Institute of Technology, under Air Force Contract F19628-85-C-0002.					
16. Abstract <i>Traffic Alert and Collision Avoidance System</i> Subsequent to the development of TCAS equipment for fixed-wing aircraft, a follow-on effort addressed the suitability of such equipment for use in helicopters. This program focused on those differences between helicopters and fixed-wing aircraft that might be expected to affect TCAS performance: the large rotor, the relatively irregular shape of the fuselage, the low speeds and high turn rates typical of helicopter flights, and the over-water and low-altitude conditions typical of helicopter operations. A Bell Long Ranger helicopter was acquired and equipped with experimental TCAS equipment with full data recording capability. Flight experiments were conducted to assess air-to-air surveillance performance under challenging conditions. Other flights involved guest pilots for subjective evaluations of the TCAS performance. It was concluded that the air-to-air surveillance techniques that were originally developed for use in large jet airliners will also perform satisfactorily in helicopters. The bearing accuracy of traffic advisories, while somewhat degraded because of the effects of the rotor and the shape of the helicopter fuselage, will nevertheless be sufficient to aid the pilot in visual acquisition of traffic. It was also concluded that, because of the flight characteristics of helicopters, the pilot display should consist of traffic advisories alone, without resolution advisories. <i>Keywords:</i>					
17. Key Words TCAS Collision avoidance; Helicopters Pilot Angle-of-arrival			18. Distribution Statement Document is available to the public through the National Technical Information Service, Springfield, VA 22161.		
19. Security Classif. (of this report) Unclassified		20. Security Classif. (of this page) Unclassified		21. No. of Pages 110	22. Price

EXECUTIVE SUMMARY

There is an increasing interest in the problem of mid-air collisions involving helicopters. Beginning in 1983, the FAA undertook a program to assess the usefulness of TCAS equipment for installation in helicopters.

The Traffic Alert and Collision Avoidance System, or TCAS, provides pilots with advisories to help maintain separation from other transponder-equipped aircraft. TCAS equipment may be classified according to the nature of its advisories: TCAS I provides aircraft position information (traffic advisories) only. TCAS II adds vertical avoidance advisories to the traffic advisories. TCAS III adds horizontal avoidance advisories.

It was decided at an early stage in the FAA program that resolution advisories, whether vertical or horizontal, would be inappropriate for use in helicopters, and thus a helicopter TCAS would be, by definition, a "TCAS I". The program that followed assessed the surveillance performance of TCAS equipment in a helicopter and addressed the reactions of helicopter pilots to the traffic advisories.

Conditions Specific to Helicopters

Prior to this program, the work to develop TCAS, including extensive airborne testing, was focused on fixed-wing aircraft. In helicopters a number of conditions are different. Some of these might be expected to adversely affect TCAS performance and possibly to warrant design changes.

Figure ES-1 shows a comparison between a large fixed-wing jet aircraft and three popular helicopters. The main rotor blade, which is metallic in most helicopter airframes, may be expected to affect the radio signals to and from a TCAS antenna mounted on the helicopter. Such effects may include reductions in signal power, reductions in link reliability, and degradations in the azimuth accuracy of the TCAS angle-of-arrival antenna. Detrimental effects may also be expected from the relatively irregular shape of the helicopter fuselage. By comparison, the jet airliner has a clean shape, affording a good view for both top and bottom antennas in most directions.

Multipath reflections of TCAS radio signals from the ground are responsible for a number of the design characteristics of TCAS equipment. Helicopters often fly over water; in many cases a helicopter lane is defined by the path of a particular river or other waterway. Helicopters also generally fly lower in altitude than typical fixed wing passenger aircraft. For both of these reasons, it was thought that a helicopter TCAS might experience a more severe multipath environment than does a fixed wing aircraft. Finally, when flying in cities, multipath reflections from tall buildings may also be significant. One objective of the development program was to assess TCAS performance degradations, if any, that result from these different conditions.

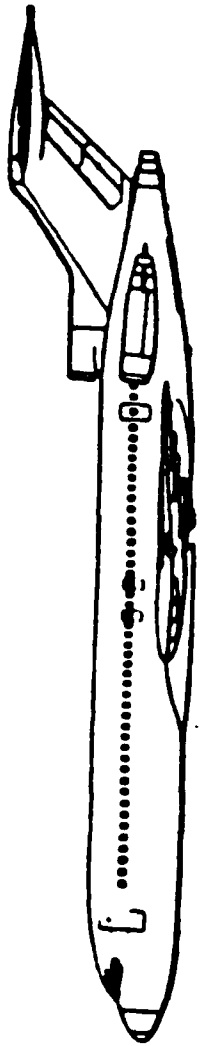

BOEING 727

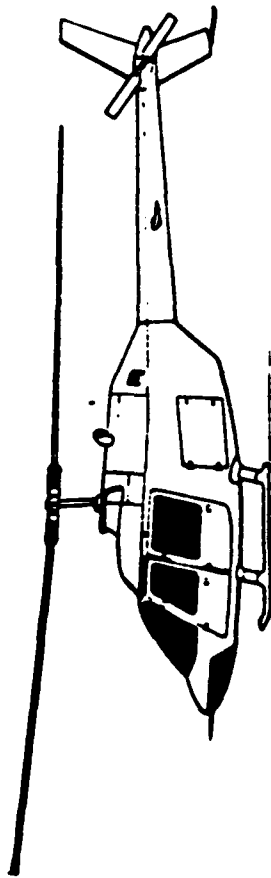

BELL 'JET RANGER'

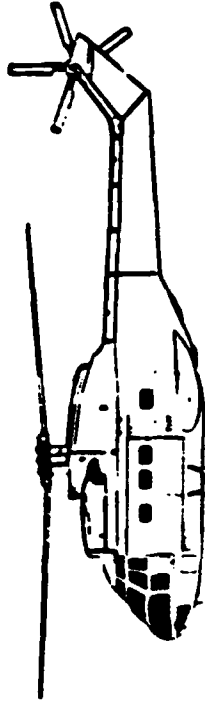

AEROSPATIALE 'PUMA'

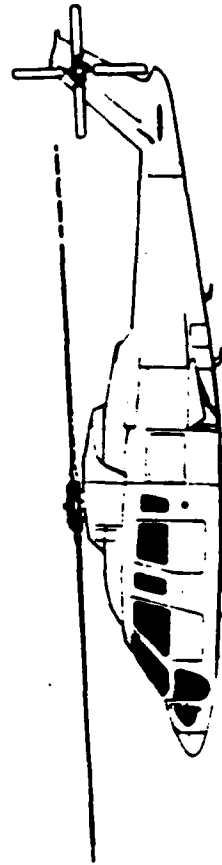

SIKORSKY S-76

Fig. ES-1. Comparison between helicopters and fixed wing aircraft.

CONTENTS

Executive Summary	111
Illustrations	ix
Tables	x
1. INTRODUCTION	1
1.1 TCAS	1
1.2 TCAS Types	1
1.3 Program Goals	1
1.4 The Role of TCAS Resolution Advisories	2
1.5 The Rotorcraft Environment	3
1.5.1 The Operational Environment	3
1.5.2 The Rotorcraft Airframe	3
1.5.3 The Multipath Environment	4
1.5.4 Practical Differences	4
1.6 Design Issues	4
1.7 Scope of Study	4
1.8 Organization of This Report	5
2. APPROACH	6
2.1 Test Program	6
2.2 Helicopter Selection	6
2.3 AMF Equipment	10
2.4 TCAS Experimental Unit (TEU)	10
2.4.1 TEU Hardware	10
2.4.2 TEU Display Logic	10
2.5 Antenna Placement	17
2.6 Bearing Estimation Technique	21
3. LINK RELIABILITY	22
3.1 Link Reliability Overview	22
3.2 Air-to-Air Multipath Effects for Helicopter TCAS	22
3.3 Effects of Rotor Angle on Link Reliability	23
3.3.1 Ground Measurements of Rotor Effects	23
3.3.2 Airborne Measurements of Rotor Effects	26
3.3.3 Conclusions Regarding Rotor Effects	28
3.4 Received Power	28
3.5 Track Reliability	31
3.5.1 Mode S Track Reliability, 1000 ft Altitude	31
3.5.2 Mode S Track Reliability, 2000 ft Altitude	33
3.5.3 ATCRBS Track Reliability, N.Y.C. Airspace	38
4. ANGLE-OF-ARRIVAL (AOA) PERFORMANCE	43
4.1 AOA Calibration Measurements	43
4.2 Airborne Measurements	44
4.2.1 General Considerations	44
4.2.2 Bilateration to Determine Actual Bearing	46

CONTENTS (CONT'D)

4.2.3	Windscreen Calibration Marks to Determine Actual Bearing	48
4.2.4	Shaft Encoder Sight to Determine Actual Bearing	53
4.2.5	Shaft Encoder Sight Measurements Hovering Just Above Ground	53
4.2.6	Hovering Measurements After Removal of Bias	55
4.2.7	Aft Performance, Hovering Above Ground	59
4.2.8	Hovering at an Altitude of 500 ft	59
4.2.9	Stability of the AOA System	62
4.3	AOA Accuracy in Planned Airborne Encounters	65
4.3.1	Introduction	65
4.3.2	Encounter Measurements with Forward Antenna	65
4.3.3	Encounter Measurements with Aft Antenna	68
4.3.4	Bearing Tracker Performance in Helicopter Turns	68
4.4	Possible Use of Absorbing Material to Improve AOA Accuracy	70
4.4.1	The Need for Absorbing Material	70
4.4.2	Anechoic Chamber Measurements of Absorbing Material	71
4.4.3	Hovering Tests of Absorbing Material	71
4.4.4	The Effectiveness of Absorbing Material	76
5.	CONCLUSIONS	77
5.1	General Conclusions	77
5.2	Specific Link and Track Reliability Conclusions	77
5.3	Bearing Estimation Performance	78
6.	REFERENCES	79
APPENDIX A	BEARING ACCURACY ANALYSIS	A-1
APPENDIX B	LOWER-COST TECHNIQUES FOR HELICOPTER TCAS	B-1

ILLUSTRATIONS

ES-1	Comparison between helicopters and fixed wing aircraft	iv
2-1	Selected helicopter (Long Ranger) as compared with Jet Ranger	8
2-2	Long Ranger with TCAS installed	9
2-3	The Airborne Measurement Facility (AMF)	11
2-4	The TCAS Experimental Unit (TEU)	12
2-5	The TEU installation in the Long Ranger	13
2-6	The Long Ranger instrument panel with TCAS display to the left	14
2-7	Close-up of the TCAS display installation in the Long Ranger cockpit	15
2-8	Example of a monochrome traffic advisory display	16
2-9	Top view of Long Ranger showing direction-finding antennas	18
2-10	Detail view of top-forward antenna array	19
2-11	Detail view of top-aft antenna array	20
3-1	Low altitude multipath measurements	24
3-2	Effect of Rotor Position and Target Bearing on Link Reliability	25
3-3	Link reliability histograms	27
3-4	Received power, encounter no. 1	29
3-5	Tracking performance from encounter no. 1	32
3-6	Mode S surveillance performance in head-on encounters	35
3-7	Mode S surveillance performance in overtaking encounters	36
3-8	Mode S surveillance performance in crossing encounters	37
3-9	Whisper-shout sequence used in the helicopter measurements in New York	39
3-10	TCAS air-air surveillance during 15 close encounters in New York	40
4-1	Bearing calibration check, on the ground	45
4-2	Flight path	47
4-3	AOA transfer function, two westbound passes	49
4-4	AOA transfer function, two eastbound passes	50
4-5	AOA transfer function measured airborne	51
4-6	Airborne AOA measurements using the windscreen sighting system	52
4-7	Airborne AOA measurements using shaft encoder sighting system	54
4-8	AOA performance hovering just above the ground (30 Nov. 84)	56
4-9	AOA performance hovering just above the ground (12 Dec. 84)	57
4-10	AOA transfer function, hovering just above the ground, new bias offset value	58
4-11	Metal objects in the vicinity of the helicopter antenna	60
4-12	AOA transfer function, top-aft helicopter antenna	61
4-13	AOA transfer function, helicopter at 500 ft. altitude	63
4-14	AOA warm-up behavior	64
4-15	Top mounted helicopter antenna stability	66
4-16	Two encounters with crossing aircraft	67

ILLUSTRATIONS

4-17	Comparison of forward antenna and aft antenna bearing estimation performance for a target in the forward direction	69
4-18	Anechoic chamber results when a simulated helicopter shaft is present	72
4-19	Anechoic chamber results with absorbing material added	73
4-20	Antenna gain measurements in anechoic chamber	74
4-21	AOA performance using absorbing material	75
A-1	Standard form of the AOA antenna	A-2
A-2	AOA antenna analysis	A-3
A-3	Analysis of performance in the absence of reflectors and in the absence of mutual coupling between array elements	A-4
A-4	Calculated antenna performance in the absence of reflectors	A-5
A-5	Geometry of reflection calculation	A-7
A-6	Calculated antenna performance with reflector 39 inches away	A-8
A-7	Calculated Antenna Performance with reflector 20 inches away	A-10
A-8	Characteristics of the antennas tested	A-11
A-9	Measured antenna patterns	A-12
A-10	Measured elevation patterns compared with the ideal	A-13
A-11	Measured AOA performance of the antenna	A-16

TABLES

2-1	Helicopter TCAS Test Missions	7
3-1	Calculation of Received Power at the Helicopter (From the Bonanza)	30

1. INTRODUCTION

1.1 TCAS

The Traffic Alert and Collision Avoidance System (TCAS) is an airborne collision avoidance system that performs air-to-air surveillance on nearby transponder-equipped aircraft and provides the pilot with advisories to assist him in maintaining safe separation from the aircraft under surveillance.

1.2 TCAS Types

TCAS may be classified according to the nature of the advisories it provides. Three levels of TCAS advisory capability have been defined:

- TCAS I [Ref. 1,2,3] - Provides traffic advisories only, most commonly in the form of plan-position graphical displays of aircraft that are detected to be close in both range and altitude.
- TCAS II [Ref. 4,5,6] - Adds vertical resolution advisories to indicate to the pilot whether he should ascend or descend to avoid a collision.
- TCAS III [Ref. 7] - Adds horizontal resolution advisories to indicate whether the pilot should turn left or right to avoid a collision.

1.3 Program Goals

Heretofore the main concern of the TCAS development effort has been to develop systems suitable for implementation in fixed-wing aircraft. However, it has been recognized that TCAS could be very useful in rotorcraft as well. Rotorcraft differ in a number of ways that might affect TCAS performance. The Federal Aviation Administration thus initiated a study to determine what capabilities of TCAS would be most useful for helicopters and what design changes, if any, would be required in moving TCAS from a fixed-wing environment to a rotorcraft environment.

Experimental TCAS equipment and associated flight data recorders were flight tested in a Bell Long Ranger helicopter. These tests were used to determine both the operational acceptability of TCAS in helicopters and the surveillance performance of the TCAS equipment in the helicopter environment. The results of the operational assessment are reported in Ref. [8]. This report summarizes the surveillance performance.

With the exception of its direction-finding antenna and subsystem, the experimental TCAS equipment used in this study employed a surveillance capability appropriate for TCAS II. The direction-finding technique used in this equipment employed omnidirectional antennas and was thus more consistent with a lower-cost TCAS I level of surveillance performance.

It followed that the specific goals of this program were to determine if a TCAS II surveillance design would perform satisfactorily in the rotorcraft environment and to determine if any surveillance and display changes would be required to a TCAS II design to improve its utility in that environment.

1.4 The Role of TCAS Resolution Advisories

Early in the rotorcraft TCAS program it was concluded that TCAS I is most appropriate for the helicopter application from the standpoint of the type of advisories it generates. This conclusion was subsequently born out by rotorcraft subject pilot flight tests.

The vertical resolution advisories generated by TCAS II are not appropriate for rotorcraft for several reasons. These reasons are summarized in the following quote from a letter on this subject written to the FAA by S.J. Mulder and N.A. Spencer of the MITRE Corp. following a study to determine the need for and feasibility of providing resolution advisories in Rotorcraft TCAS*:

"Several factors were studied in making this decision, and the primary conclusion is that a system issuing vertical RAs in addition to TAs would not greatly improve safety over a TA-only system. The two main differences from fixed-wing aircraft are lower speed encounters, and a wider visual field of view. Our reasoning can be summarized as follows:

1. Helicopters today operate almost exclusively in VMC, and pilots are accustomed to maintaining visual separation. Pilots prefer simple advisories that can help locate traffic. While the traffic encountered is usually closing at low speeds, a fact common to most reported near misses is that the traffic often was not sighted until close range despite good visibility. Many near misses are overtake situations where the helicopter pilot cannot see the threat approaching from the rear. Traffic advisory information would give a timely alert at a range close enough to see the threat, and would therefore help the helicopter pilot to visually acquire the traffic at a greater range.
2. The unique operating environment and flight capabilities of helicopters introduce restrictions on the resolution logic. Helicopter climb and descend capabilities vary considerably with airspeed, altitude, and airframe model. The logic would need these inputs to determine what escape rate was possible, and would need to model the maneuver appropriately. At very low airspeeds some models may not be able to achieve an adequate vertical escape rate.
3. Vertical-only RAs would not utilize the better part of the helicopter's maneuverability and may often conflict with the pilot's selection of the horizontal plane as the most appropriate escape. Pilots maintain visual separation reliably due to the low closing speeds of encounters. Pilots generally use a combination of vertical and horizontal maneuvers to avoid traffic. However, an RA would

*RA denotes resolution advisory. TA denotes traffic advisory. VMC denotes visual meteorological conditions.

always be limited to a vertical maneuver, and may be limited even further depending upon airspeed and altitude. At very low altitudes a descend advisory should not be generated, and at very low airspeeds a climb advisory should not be generated. Unlike fixed wing aircraft, helicopters are flown in these regimes regularly."

1.5 The Rotorcraft Environment

In one respect the rotorcraft surveillance problem is easier than the fixed-wing surveillance problem. Because civil helicopters fly more slowly than fixed-wing aircraft, the average closing speed of a helicopter with respect to approaching aircraft will be less. Thus, if it is desired to achieve a track on an approaching aircraft by the time it comes within a visual acquisition range of 3 miles, for example, the rotorcraft TCAS unit can afford to establish a track on the approaching aircraft slightly later than can the fixed-wing TCAS. As a result, the range capability of the TCAS in the forward direction should be adequate for rotorcraft installations if it is adequate for fixed-wing applications in the same airspace.

There were, however, at the beginning of this study a number of ways in which it was thought that TCAS surveillance techniques might need to be improved in moving from fixed-wing to rotary-wing aircraft.

1.5.1 The Operational Environment

The rotorcraft operational environment is different from the fixed-wing operational environment. For instance, turning rates are typically greater than for fixed-wing aircraft. Thus it was thought that target direction-finding techniques might need to be modified to provide more rapid tracking of own-aircraft rotation than is typically required for fixed-wing aircraft. Specifically, some sort of on-board heading sensor might be required.

Finally, rotorcraft often operate in very close proximity to each other, so that the minimum surveillance range of a rotorcraft TCAS will typically be less than the minimum range of a fixed-wing TCAS. As the surveillance range decreases, the dynamic range of the received signals typically increases. It was thought that this might have implications on the selection of the power levels used in the interrogation sequence (known as the "whisper-shout" sequence) used for reducing the effects of synchronous garble and on the selection of the dynamic threshold level used for eliminating multipath.

1.5.2 The Rotorcraft Airframe

Typical civil rotorcraft airframes are not well suited for transmitting and receiving L-band beacon signals. There is typically no unobstructed location available on the airframe for locating an antenna. There are many surfaces and obstructions on typical rotorcraft bodies that have dimensions and separations from the antenna that are on the order of a wavelength (about one foot) at the 1030-1090 MHz frequencies used by TCAS. The rotor shafts and blades are typically large metal reflectors that change position from one TCAS

transmission to the next. The rotor turns at a rate of several revolutions per second and thus it was originally thought that it might be beneficial to synchronize the TCAS transmissions so they always occur at a fixed rotor position.

1.5.3 The Multipath Environment

The magnitude and severity of ground-bounce multipath has been found to increase at low altitudes. In addition, rotorcraft often fly in urban environments at altitudes lower than the heights of many of the taller buildings. As a result there may often exist two or more significant reflection paths disturbing the desired transmission.

1.5.4 Practical Differences

There are also significant practical differences between helicopter avionics and fixed-wing avionics. Avionics size and weight are always important considerations in any aircraft. However, size and weight are even more important concerns in civil rotorcraft, whose small cockpits and limited payloads allow room for only the most essential avionics devices. This means that the TCAS equipment must be packaged as simply and compactly as possible, preferably with a single electronics enclosure and an integrated display and control head, and a minimum of interconnecting wires and cables. Because of this, there is a tendency on the part of civil helicopter operators to favor the installation of low-cost general aviation avionics whose simple designs often result in less size and weight.

1.6 Design Issues

A principal design issue is whether a suitable location can be found on the helicopter airframe for a single, low-cost combined surveillance and direction-finding antenna that allows for acceptable TCAS link margins and acceptable bearing estimation accuracy. Other design issues are the required transmit power and sensitivity, possible required technical changes to overcome multipath and to support extreme short range surveillance, and possible required changes to the TCAS tracking techniques to accommodate rapid aircraft rotations.

1.7 Scope of Study

To investigate the above issues, experimental TCAS equipment (which, with the exception of its omni-directional angle-of-arrival antenna, had the surveillance capability of an aircarrier TCAS II) and associated flight data recorders were installed in a Bell Long Ranger helicopter. Both planned and random encounters were recorded against Mode S and ATRBS-equipped aircraft. In addition to numerous ground tests and low-altitude hovering tests, missions were flown along high-density operational helicopter routes in the Boston and New York City areas. Suitable cockpit displays were also investigated, and subject helicopter pilot reaction obtained. The acceptability of TCAS II to helicopter pilots from an operational viewpoint was assessed during test missions flown by 12 subject pilots. (As noted above, results of those investigations are reported in Ref. 8.)

1.8 Organization of This Report

This report presents the results of the helicopter surveillance investigations, and the results of the analysis of the flight data obtained. In addition, this report includes descriptions of important design details of the experimental direction-finding equipment. The intention has been to provide enough design information so that a potential manufacturer of rotorcraft TCAS equipment can estimate roughly what it would cost to build an equivalent direction-finding system, and how much size and weight would be involved.

This report consists of four major sections: Section 2 provides overview and general information; Section 3 covers link reliability (rotor effects, antenna installation, surveillance processing issues); Section 4 covers relative bearing determination, or angle-of-arrival (AOA) performance; and Section 5 presents conclusions.

2. APPROACH

2.1 Test Program

The helicopter TCAS measurements program consisted of three groups of "in-aircraft" test missions both on the ground and in the air using two small fixed-wing aircraft and a Bell Jet Ranger helicopter. A group of exploratory antenna measurements was also run in an anechoic test chamber. These tests are listed in Table 2-1.

Initial measurements, begun before the helicopter arrived and before the necessary modifications to it were made, used the Lincoln Laboratory Airborne Measurements Facility (AMF) equipment mounted in a Cessna-421 fixed-wing aircraft flying against a ground test transponder or the Lincoln Laboratory Mode S experimental sensor. The purpose of these tests was to make angle-of-arrival calibration runs, and to shake down equipment that was later to be transferred to the helicopter. Early helicopter measurements employed the AMF equipment (without direction-finding capability) for static tests of the effect on link reliability of rotor position and antenna location, and for the assessment of surveillance performance during planned encounters against a Mode S transponder in a Bonanza aircraft.

Once the TCAS Experimental Unit (TEU) was installed in the helicopter and equipment and test instrumentation had been thoroughly shaken down, flights to assess angle-of-arrival (AOA) accuracy began. Flights were made against a Mode S transponder in another aircraft, and on the ground. Flights were made to assess bearing estimation accuracy while hovering close to the ground and at altitude. An important set of flights was made in the Metropolitan New York City area to examine ATCRBS surveillance performance in a dense environment and to assess track performance during close encounters on ATCRBS targets-of-opportunity. These flights were followed by flights in the Boston area to obtain pilot reaction.

After it became apparent that the main rotor mast and control rod assembly and nearby fuselage appendages were degrading bearing accuracy, the AOA antenna and simulated portions of the helicopter airframe environment were set up in an anechoic chamber to examine their effects in detail.

2.2 Helicopter Selection

The civilian helicopter selected for the reported investigations was a Bell 206 Long Ranger, a stretched version of the Bell 202 Jet Ranger. Outline drawings of both helicopters are shown in Fig. 2-1. Although the first choice was the Jet Ranger because it is one of the most popular and widely used civilian helicopters, it was found to be too small to carry all the TCAS equipment and associated test gear. Hence the otherwise nearly identical, Bell Long Ranger was selected. The antenna installation problems on this helicopter are very similar to those on a large portion of the helicopter fleet in the United States. Fig. 2-2 is a photograph of the Long Ranger at the Lincoln Laboratory Flight Facility at Hanscom Field.

TABLE 2-1

HELICOPTER TCAS TEST MISSIONS

L/R = Link Reliability
 A/C = Angle-of-Arrival Calibration
 A/P = Angle-of-Arrival Performance
 LLFF = Lincoln Laboratory Flight Facility
 MODSEF = Mode S Experimental Facility (ground based secondary surveillance radar)

<u>NO.</u>	<u>EQUIP. CONFIG./LOCATION</u>	<u>PURPOSE OF TESTS</u>
<u>AMF in Cessna 421</u>		
1)	Hanscom, on ground	L/R at four field sites vs horn at LLFF.
2)	Hanscom, at loc. "A"	A/C.
3)	Hanscom, in the air	A/P against MODSEF.
<u>AMF in Long Ranger</u>		
1)	Hanscom, on ground	L/R vs rotor and target angles.
2)	Boston area	Eight head-on encounters vs Mode S equipped Bonanza.
3)	Boston area	Six head-on encounters, two closing-from-rear encounters, two crossing encounters.
<u>TEU in Long Ranger</u>		
1)	Hanscom, on ground	A/C
2)	Hanscom, in the air	A/C against Billerica water tower mounted Mode S transponder.
3)	Hanscom, in the air	A/P against Mode S equipped Bonanza drifting from side to side, 1 mile ahead.
4)	Hanscom, near ground	A/P against LLFF transponder.
5)	Metropolitan NYC	Surveillance performance; % of hits under which track was maintained during 15 close encounters.
6)	Hanscom, near ground	A/P.
7)	Hanscom, hovering @ 500'	A/P.
8)	Boston area	Performance critique by five helicopter subject pilots.
<u>AOA Antenna</u>		
1)	Anechoic test chamber	Characterize antenna performance independent of airframe environment.
2)	Anechoic test chamber	Explore effects of grounding connections.
3)	Anechoic test chamber	Explore effects of simulated rotor shaft.
4)	Anechoic test chamber	Explore effects of RF absorbing material between antenna and rotor shaft.
5)	Anechoic test chamber	Measure bearing offset value.
6)	Anechoic test chamber	Explore effects of reflecting objects and interposed absorbing materials.
7)	Anechoic test chamber	Measure physical separation for 20 dB isolation from Mode S antenna.

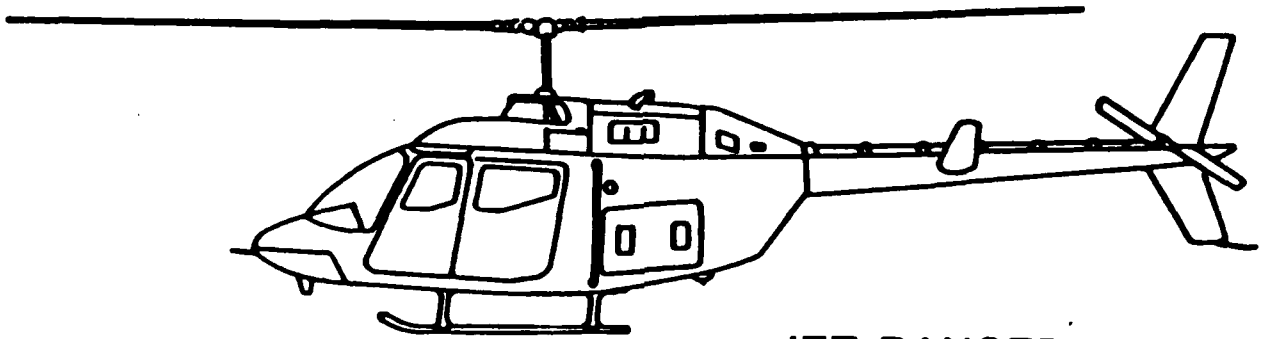

JET RANGER

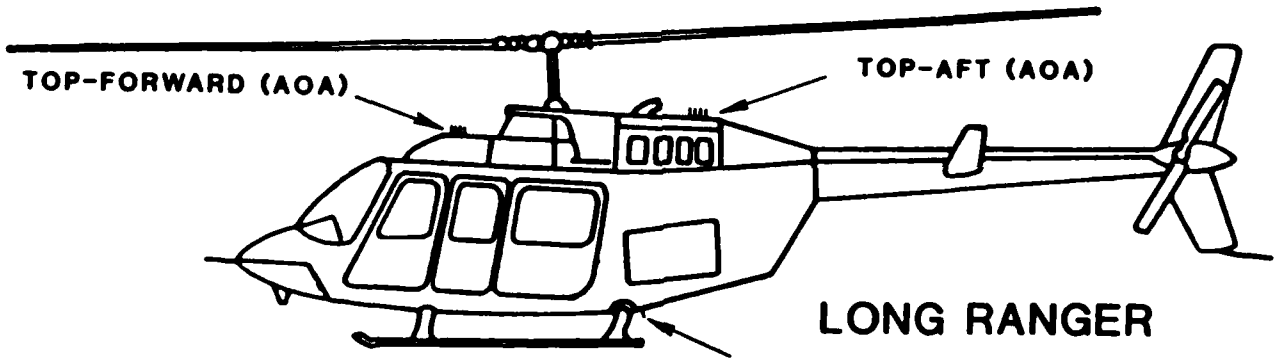

LONG RANGER
BOTTOM (MONOPOLE)

Fig. 2-1. Selected helicopter (LONG RANGER) as compared with JET RANGER

101125

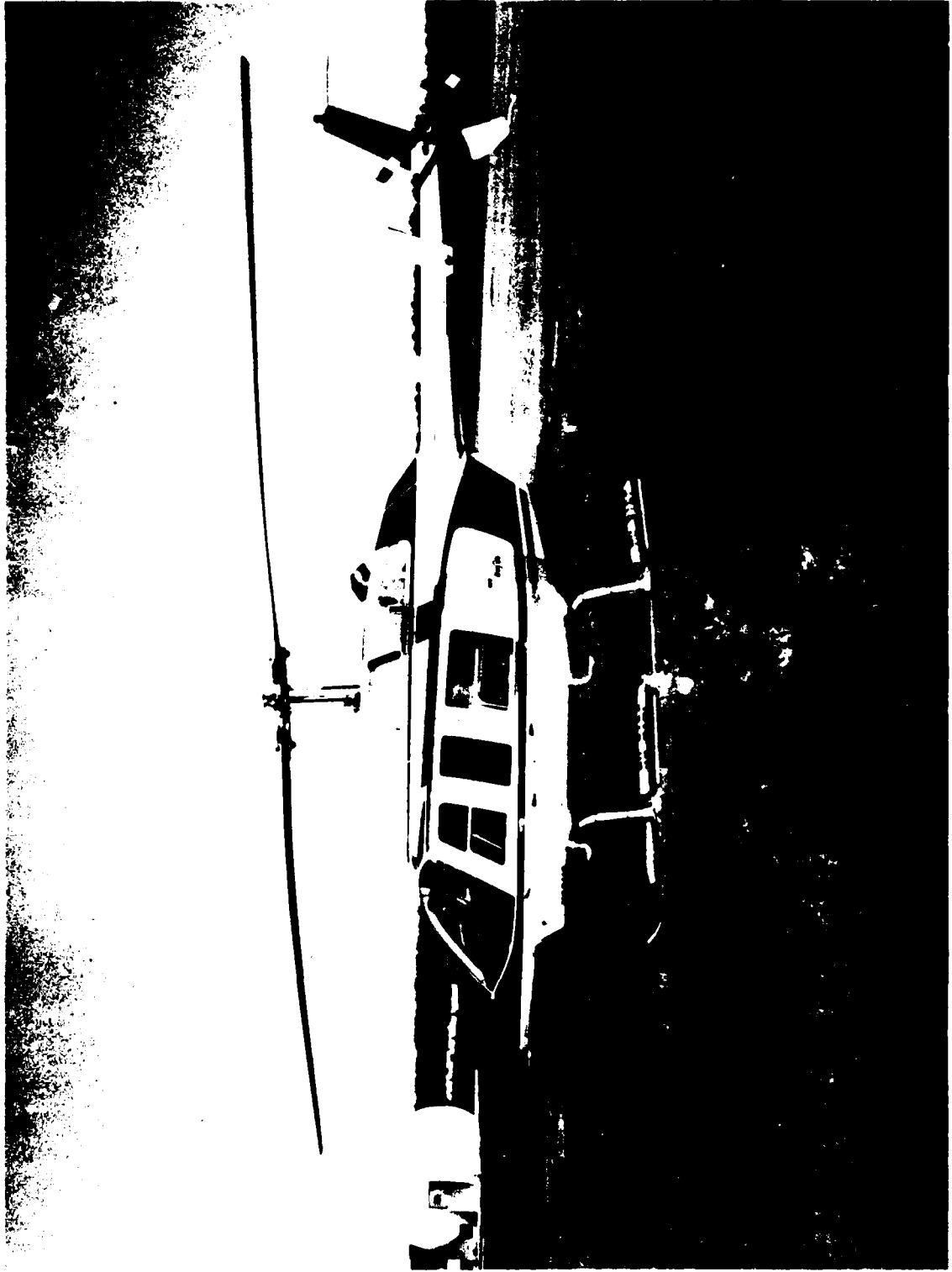

Fig. 2-2. Long Ranger with TCAS installed.

2.3 AMF Equipment

The AMF, essentially an airborne, instrumented, multi-mode receiver with high data rate recorder was used in evaluating link reliability, and obtaining flight data useful later in laboratory evaluation of tracking performance. The AMF recorder, control unit, receiver/processor, and power supply are illustrated in the photograph of Fig. 2-3.

The AMF can stimulate transponder replies from nearby aircraft by transmitting ATCRBS and Mode S interrogation waveforms at 1030 MHz. It can receive at either 1030 or 1090 MHz. The AMF samples and digitizes received signals. The digitized samples are processed to recognize the occurrence of individual pulses or complete ATCRBS and Mode S replies. The presence of pulses or replies are recorded on instrumentation magnetic tape. In the case of pulses, the width, amplitude, and (optionally) the bearing angle of each received pulse is recorded. In the case of replies, the amplitude, data bits, and (optionally) the bearing angle are recorded.

2.4 TCAS Experimental Unit (TEU)

2.4.1 TEU Hardware

In the experimental flights in which surveillance and bearing estimation (AOA) functions were evaluated, TCAS surveillance and computer functions were provided by a TCAS Experimental Unit. The TEU (Figs. 2-4 and 2-5) was built by Lincoln Laboratory and has been used extensively in the development of the fixed-wing TCAS design. For these tests the TEU employed waveforms, reply processing algorithms, and tracking algorithms that conformed to the TCAS II specifications of Ref. 4 in most significant particulars. The tracked positions of all traffic of interest were updated once per second and displayed to the pilot on a color weather radar indicator (Figs. 2-6 and 2-7) in plan-position format.

2.4.2 TEU Display Logic

The TCAS display logic employed in the TEU was a modified version of the TCAS II traffic advisory display logic specified in Ref. 4. The helicopter traffic advisory display logic did not generate resolution advisories and had no provision for sensitivity level control. As such, none of its logic parameters were altitude-dependent. Its functions were to determine which of the targets in the surveillance track file should be displayed to the pilot and to place each of the displayed targets into one of three display categories.

To be displayed, a target was required to pass either a "traffic advisory" test or a "proximity" test. The traffic advisory test was applied first to determine if longer-range targets were worthy of display because of high closing speeds. Failing the closing-speed test, a target could still be displayed simply on the basis of close proximity. An example of this distinction is illustrated in Fig. 2-8. The aircraft directly ahead of own aircraft and 600 ft below is a proximity target only, and in this convention

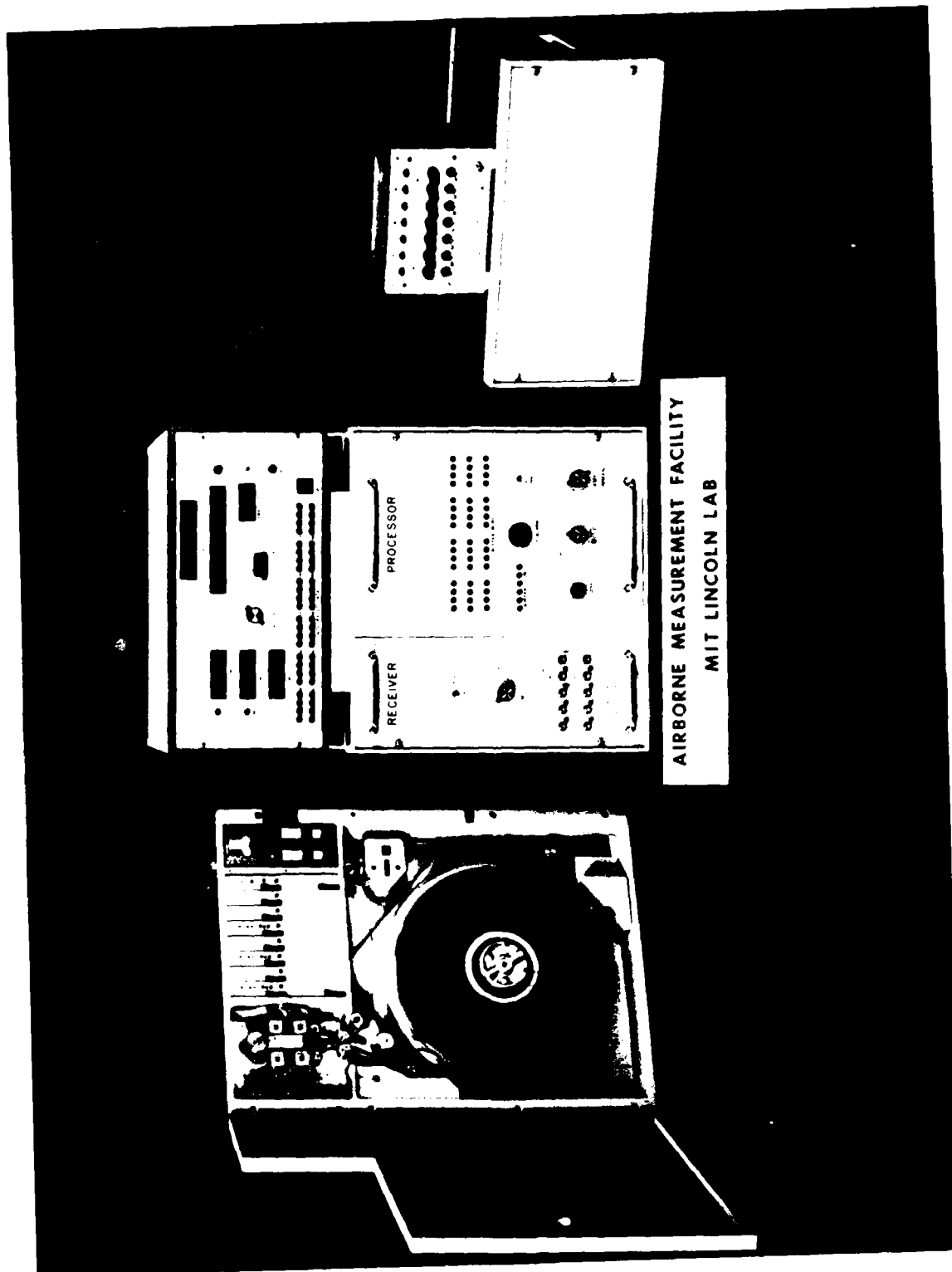

Fig. 2-3. The Airborne Measurement Facility (AMF)

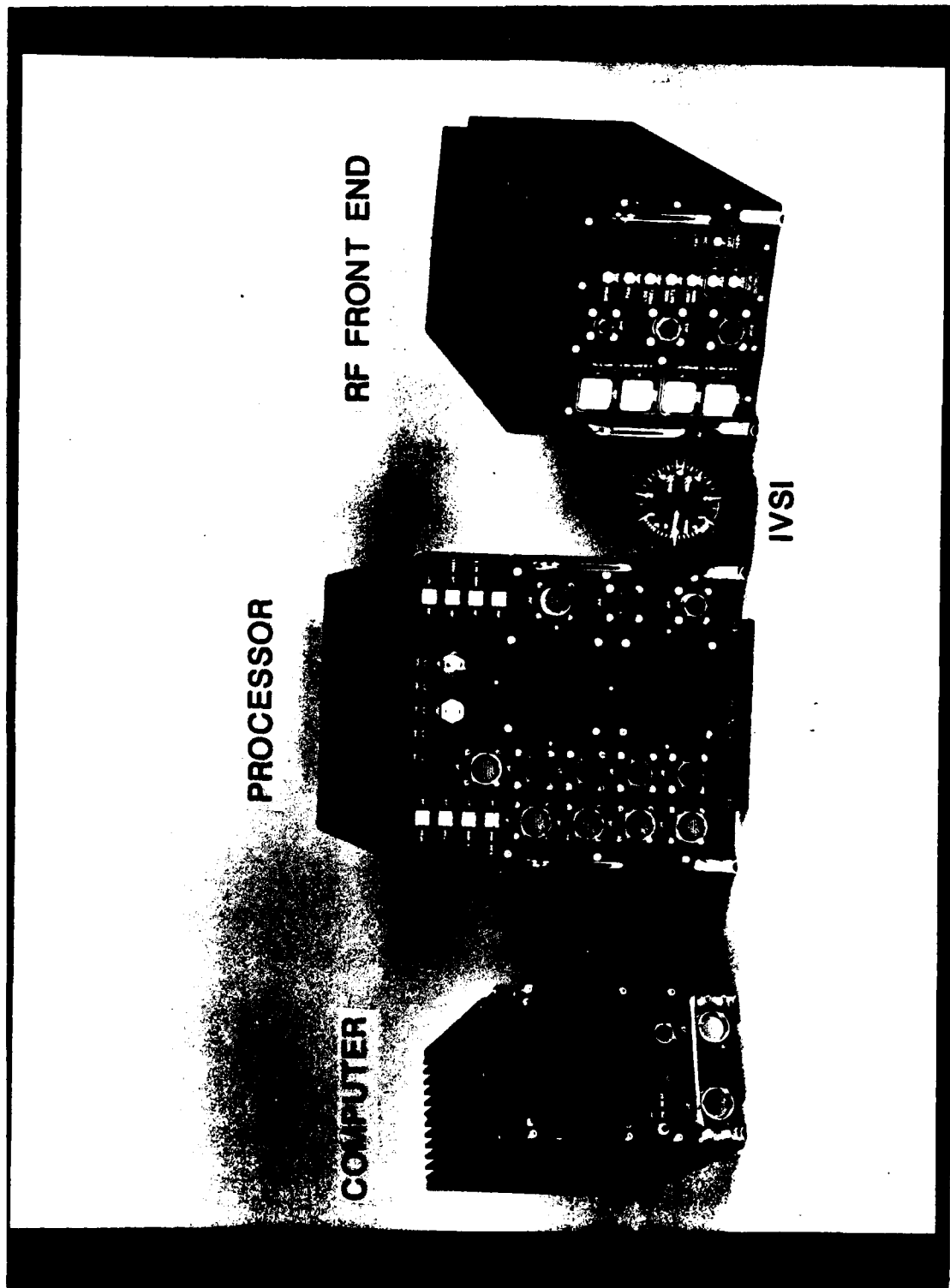

Fig. 2-4. The TCAS experimental Unit (TEU)

101670

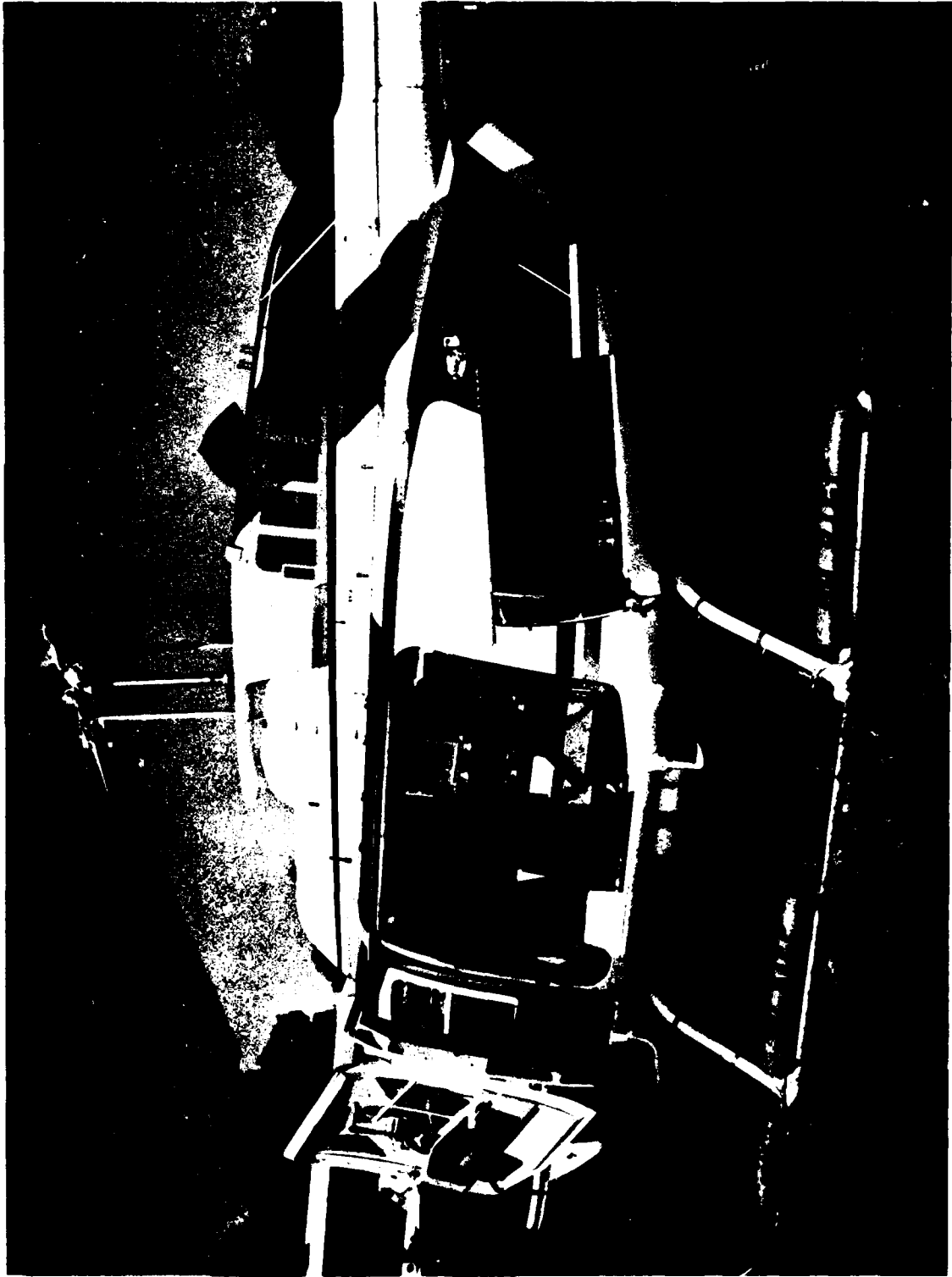

Fig. 2-5. The TEU installation in the Long Ranger



Fig. 2-6 The Long Ranger instrument panel with TCAS display to the left.

101672



Fig. 2-7. Close-up of the TCAS display installation in the Long Ranger cockpit

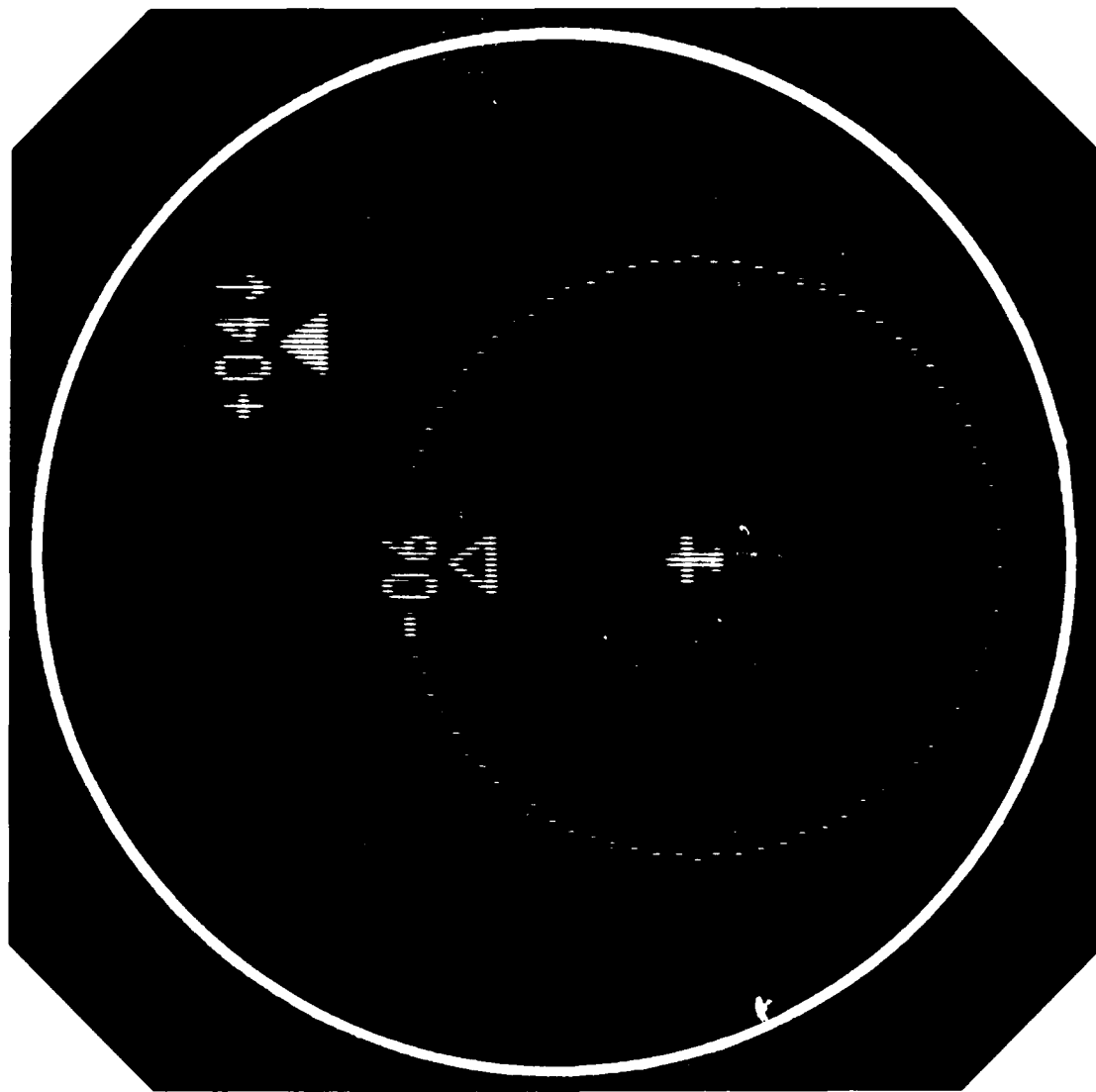

Fig. 2-8. Example of a monochrome traffic advisory display

is displayed as an open triangle. The target at 1 o'clock, longer range, 400 ft above, and descending passes the traffic advisory test and is distinguished by displaying it as a solid triangle.

Provisions were also made to place targets near the ground in a separate category. These were displayed to the pilot using a distinct symbol, an upper-case G.

The criteria for categorizing the targets were as follows:

HELICOPTER TCAS DISPLAY LOGIC CRITERIA

<u>ADVISORY TYPE</u>	<u>RANGE CRITERIA</u>	<u>ALTITUDE CRITERIA</u>
Traffic advisory	Less than 35 s to 0.20 nmi range <u>or</u> within 0.5 nmi	Within 1200 ft
Proximity	Within 5 nmi	Within 1200 ft
On-the-ground	Within 5 nmi	Within 1200 ft <u>and</u> within 300 ft of set ground level

2.5 Antenna Placement

Direction-finding antennas were mounted on the top of the helicopter in the positions shown in the diagram of Fig. 2-1 and the photograph of Fig. 2-9. It was found that there were few unobstructed places to mount an antenna on the helicopter because of the helicopter's small size and complex shape. The top-forward antenna (Fig. 2-10) is obstructed by the rotor mast and associated control mechanics. The top-aft antenna (Fig. 2-11) is obstructed in the forward direction by the engine exhaust port, and is obstructed in the aft direction by the tail assembly and tail rotor. Both are potentially affected by the main rotor blades. A bottom non-bearing-measuring antenna was mounted in the position shown, where it is obstructed by the skids, and also is somewhat inclined in the aft direction.

TCAS surveillance requirements for fixed wing aircraft call for greater range capability in the forward direction, because the forward motion makes collisions from the rear relatively less likely. Surveillance in the rear direction is somewhat more important for helicopters because they may be more easily overtaken. A top-aft antenna was installed in case it was found that the top-forward antenna did not provide sufficient coverage to the rear.



Fig. 2-9. Top view of Long Ranger showing direction-finding antennas

101675



Fig. 2-10. Detail view of top-forward antenna array

101676



Fig. 2-11. Detail view of top-aft antenna array

101677

2.6 Bearing Estimation Technique

Two slightly different approaches to bearing estimation are possible for TCAS equipment. Both employ small array antennas designed to generate pairs of distinct (sum and difference) radiation patterns. In one approach the phases of the sum and difference patterns are compared. In the other approach the amplitudes of the patterns are compared to determine the approximate angle-of-arrival of the target signal.

An amplitude comparison system typically generates four or more beams that have directionality. Separate receiver channels are needed for each of these beams. A phase comparison system typically generates omnidirectional sum and difference beams and requires only two receiver channels. Because of this, a phase comparison system has fewer components and appears to be more appropriate for TCAS installations such as in civil rotorcraft, where cost and weight are critical factors.

For these reasons the phase comparison technique was used in the experimental equipment flown as part of this study. This report includes a detailed description of the design and performance of the phase-comparison angle-of-arrival estimator.

3. LINK RELIABILITY

3.1 Link Reliability Overview

Helicopter-to-other aircraft link reliability is affected by reflections and obstructions associated with the helicopter fuselage, rotor, and mechanical appendages. Helicopters are significantly different from fixed-wing aircraft in that their airframes have fewer unobstructed flat areas for installing antennas, and the rotor blades are much larger and closer to the antennas than are fixed-wing aircraft propellers. Hence it was generally not possible to infer link reliability for helicopters from experience gained from the extensive testing done during the TCAS program for fixed-wing aircraft. However, it became apparent from fixed-wing flights that low-altitude multipath was not as serious as first thought.

The results of those multipath flights are summarized in Section 3.2 below. Section 3.3 examines the relationship between the main rotor position and the measured link reliability. Section 3.4 describes a flight test designed to examine the TCAS antenna gain as installed on the helicopter airframe. The gain is inferred from calibrated air-to-air power measurements. Section 3.5 examines the reliability of the TCAS II Mode S and ATCRBS trackers. The Mode S measurements were obtained by planned encounters with an aircraft equipped with an experimental Mode S transponder. The ATCRBS measurements were obtained against chance-encounter aircraft in the helicopter airways around New York City.

3.2 Air-to-Air Multipath Effects for Helicopter TCAS

"Air-to-air multipath" refers to the unwanted reflections from the ground that occur when TCAS signals are transmitted between two aircraft. Multipath measurements made in the initial years of the TCAS development program [Ref. 9] showed that for altitudes from 5000 to 10000 ft the air-to-air signal-to-multipath power ratio is a function of the grazing angle of the reflection from the ground and is essentially independent of altitude. Specifically, for a pair of aircraft with a top-mounted TCAS antenna and a bottom-mounted transponder antenna over the ocean (sea state 1), the signal-to-multipath ratio is greatest for grazing angles approaching 90 degrees (zero horizontal range) and drops to a minimum of 8 to 10 dB for a grazing angle of about 20 degrees.

At lower grazing angles the differential path length becomes very small and it becomes difficult to measure the signal-to-multipath ratio because the direct and reflected signals begin to overlap. However, limited data in this region indicates that the signal-to-multipath ratio gradually increases as the grazing angle drops below 20 degrees.

Low-altitude multipath measurements made between two fixed-wing aircraft just prior to the availability of the Long Ranger confirmed that the dependence of air-to-air multipath on grazing angle is the same at altitudes from 500 ft to 1000 ft as it is at altitudes of 5000 to 10000 ft.

Representative data from these measurements is shown in Fig. 3-1. In this mission, the two aircraft flew diverging flight paths over the ocean at an altitude of 1000 ft. The Cessna 421 employed a top-mounted TCAS antenna; the Bonanza employed a bottom-mounted transponder antenna. It is seen that the signal-to-multipath ratio exceeded 10 dB for all but one data point for which the range was less than 1.0 nmi (corresponding to a grazing angle of 18 degrees). Although the multipath power fluctuates widely at almost all ranges because of the random reflectivity of the ocean surface, the signal-to-multipath ratio only drops below 10 dB four times in the figure, with the minimum ratio dropping to about 6 dB at a range of about 1.1 nmi.

These results are typical of the results measured at higher altitudes. It may be concluded by comparing this data to the higher altitude results that 1) the signal-to-multipath power ratio will be greater for most other types of terrain and for larger ocean wave heights and that 2) for a top-to-bottom antenna combination, the average signal-to-multipath ratio will rarely fall below 10 dB.

However, on average, helicopters with TCAS will experience low multipath grazing angles more often than will fixed-wing aircraft. For example, at an altitude of 1000 ft, a co-altitude target detected at a range of 3 nmi will have a grazing angle of 6 degrees, whereas at an altitude of 10,000 ft, a target detected at 10 nmi will have a grazing angle of 18 degrees. Thus, for much of the time, helicopter TCAS equipment with top-mounted antennas flying over water will experience signal-to-multipath ratios of approximately 10 dB.

For this reason, it is important that helicopter TCAS equipment include the principal design features that have been found to be instrumental in overcoming ground-bounce multipath on both the interrogation and the reply links. These features are a) the use of a top-mounted antenna, b) whisper-shout, and c) dynamic minimum triggering level (DMTL). These features are integral parts of the TCAS II surveillance design and they were all included in the TCAS experimental unit used in these helicopter flight tests.

3.3 Effects of Rotor Angle on Link Reliability

3.3.1 Ground Measurements of Rotor Effects

The effects of fuselage shape and rotor blade position were first examined on the ground, where the rotor blade position could be manually controlled. The AMF was installed in the helicopter and connected to the top-forward antenna. A Mode S transponder was connected to a horn antenna mounted 15 feet up the side of a building 1550 feet away. The AMF interrogated the transponder and recorded the received replies and their power.

The fuselage effects were studied by varying the bearing of the target transponder relative to the helicopter, while the rotor effects were examined by varying its angle. As shown in Fig. 3-2, five target bearings and four rotor positions were examined.

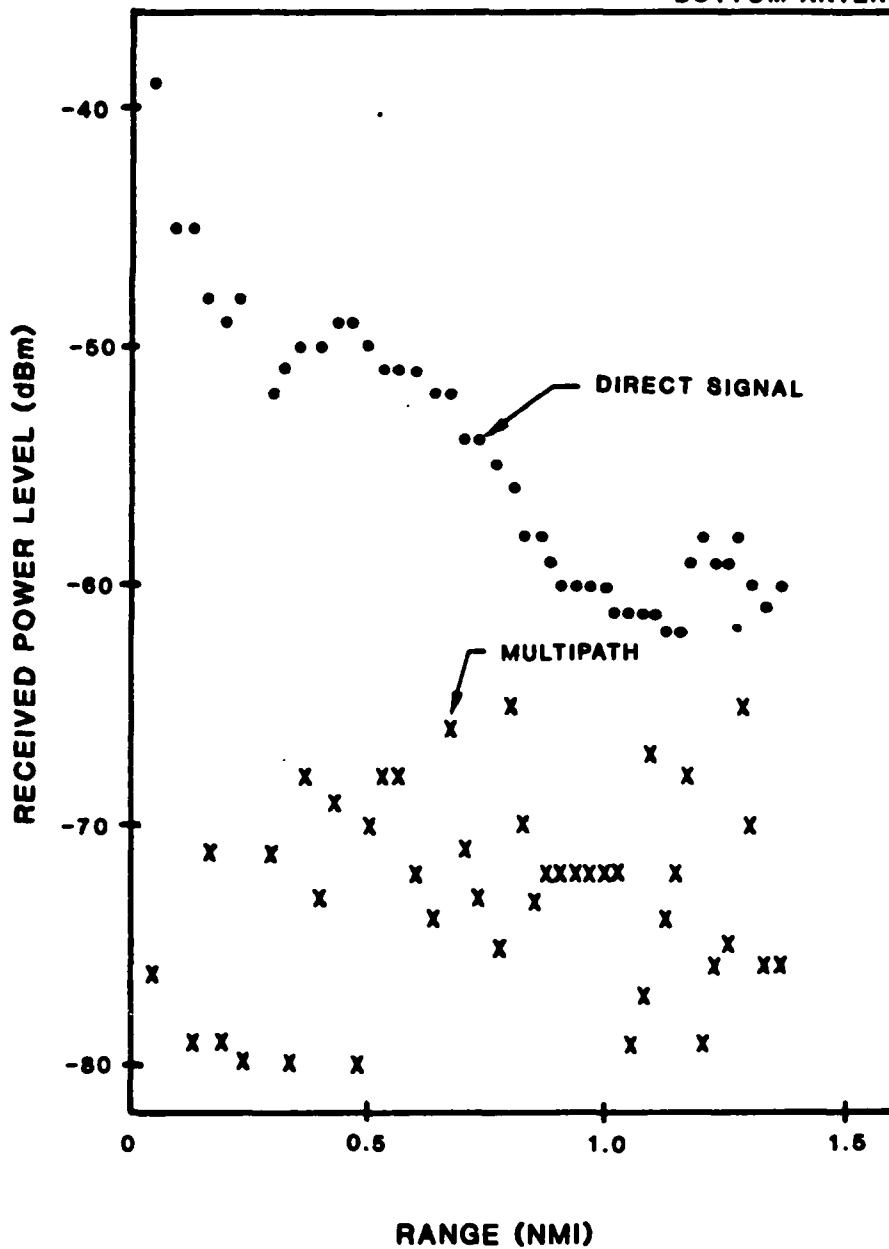
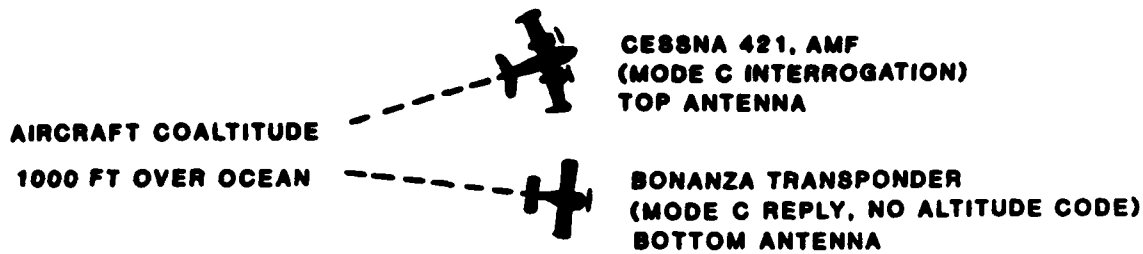
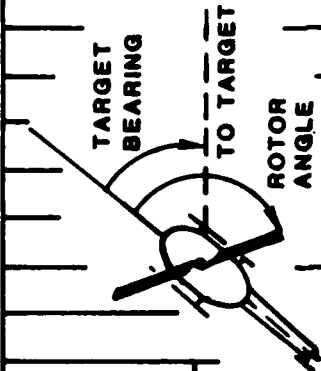

Fig. 3-1. Low altitude multipath measurements.

HELICOPTER GROUND TEST

TARGET BEARING (DEG.)	ROTOR ANGLE (DEG.)	REPLIES RECEIVED IN EACH POWER BIN (%)										OVERALL LINK RELIABILITY (%)			
-15	0											27	72	99	
	45											12	12		
	90											2	2		
	135												0		
30	0													93	96
	45											1	97		
	90											7	90		
	135											67	41		
75	0													1	69
	45													40	67
	90													69	36
	135													88	11
120	0														97
	45													9	61
	90													3	64
	135													16	67
180	0														2
	45														74
	90														21
	135														76
															98
															97
															79
															97



-30

-40

-50

RECEIVED POWER LEVEL (dBm)

Fig. 3-2. Effect of rotor position and target bearing on link reliability.

The link reliability and received power level data are combined in Fig. 3-2. The right-hand column shows the overall link reliability for each of the 20 combinations of helicopter/rotor blade positions. It can be seen that the link reliability is largely independent of rotor blade position when the target transponder is at bearings of 30, 75, and 120 degrees. The link reliability is down to 79 percent when the target is aft and the blades are perpendicular to the helicopter centerline. The link reliability when the target is 15 degrees to the left of the nose is very poor for three rotor positions and nearly perfect for one of them. But, the received power was good for all three positions for which replies were received.

3.3.2 Airborne Measurements of Rotor Effects

Link reliability was evaluated in the air during a series of planned encounters, and later using targets-of-opportunity in the Metropolitan New York City area.

Eight planned head-on encounters were flown over land in the Boston area. The helicopter altitude was constant at 1000 ft in these encounters. The encounter aircraft was a Beech Bonanza equipped with a Mode S transponder, and flying from 500 ft to 2000 ft above the helicopter. The AMF in the helicopter interrogated the Bonanza transponder 31 times per second from the top-forward antenna, and 31 times per second from the bottom antenna, and recorded the Mode S replies, their power levels, and rotor blade timing marks.

<u>Encounter</u>	<u>Helicopter Altitude (ft)</u>	<u>Bonanza Altitude (ft)</u>
1	1000	1500
2	1000	1500
3	1000	2000
4	1000	2000
5	1000	2500
6	1000	2500
7	1000	3000
8	1000	3000

A sensor generated a timing pulse each time the rotor blade passed through the helicopter centerline. The AMF recorded the times these pulses occurred. These times were used later in the analysis to determine rotor position as a function of time.

The effect of rotor blade position was evaluated by observing the number of times a reply was received to a top interrogation in each of 36 ten-degree blade-position bins. The results are shown for two encounters in the matrices in Fig. 3-3. An entry of about 18 replies indicates near perfect link reliability during a given ten-second interval over a ten degree rotor blade arc. The shaded regions include all entries for which the reply count was less than four, corresponding to a link reliability less than 22%.

ENCOUNTER 1

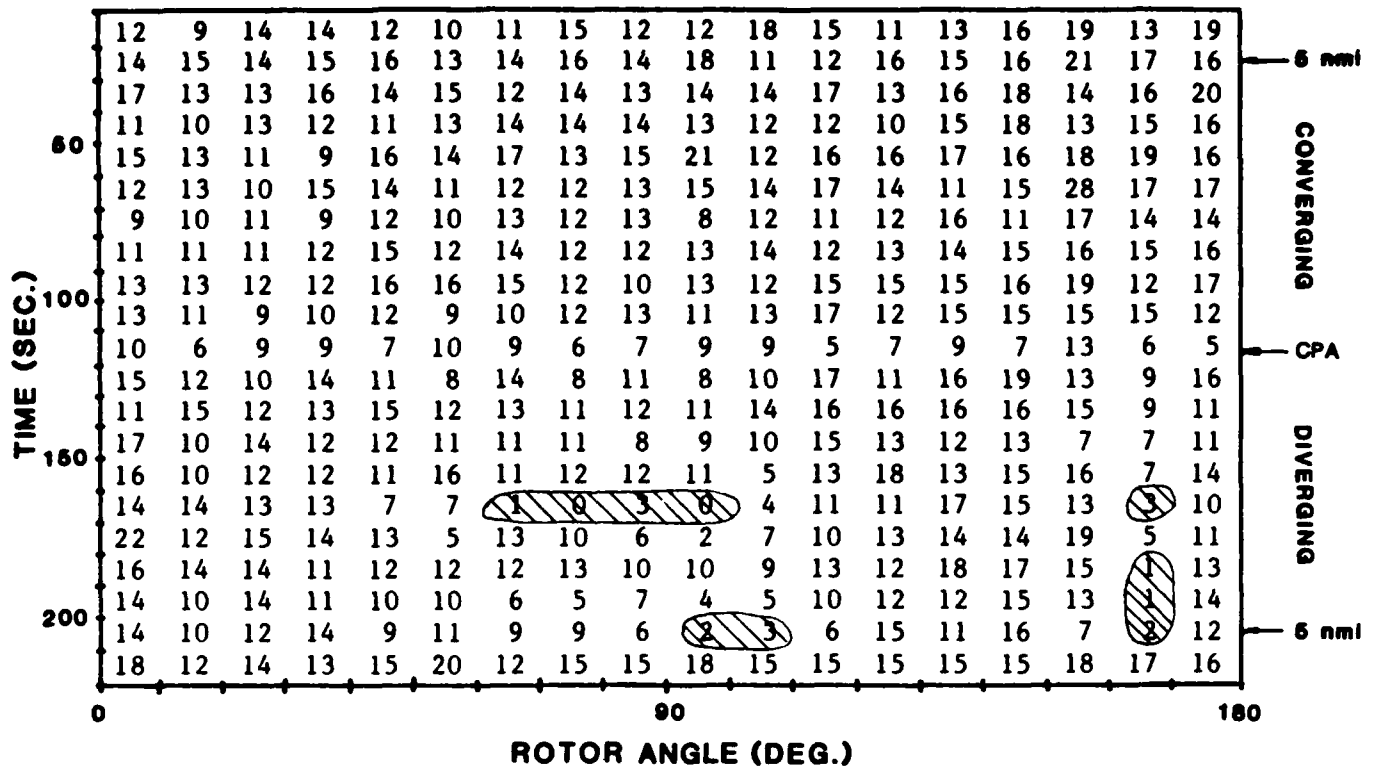

ENCOUNTER 2

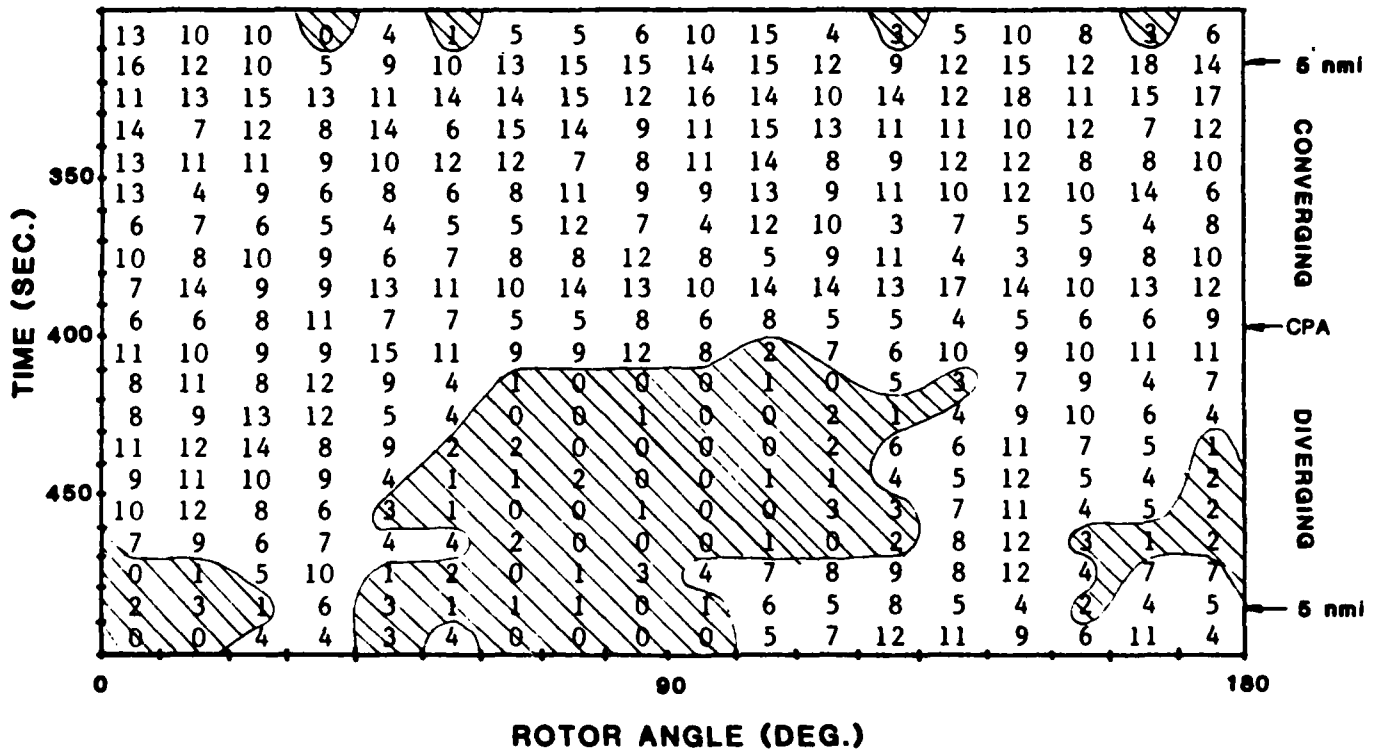

NOTE: SHADED REGION DENOTES REPLY COUNT ≤ 3
 WHICH CORRESPONDS TO LINK RELIABILITY $< 20\%$
 NOTE: CPA - CLOSEST POINT OF APPROACH.

Fig. 3-3. Link reliability histograms.

101456

A large region of low link reliability is evident in encounter 2, occurring after the closest point of approach (CPA), and for rotor angles of ninety degrees plus or minus forty degrees. This result is similar to an effect that was seen in the tests on the ground: when the target is aft, the rotor position does affect link reliability, with the worst case being ninety degrees.

This dependence of link reliability on rotor angle is seen in encounter 2 but not in encounter 1, even though the two encounters are nominally the same. Similarly, it was found that the effect was seen in all the even-numbered, and not seen in any of the odd-numbered encounters. The odd and even encounter directions of flight were 180 degrees apart. Therefore, the most likely explanation is that the wind made the helicopter crab angle large enough to cause the target to be seen at different bearings during the odd and even encounters. Overall, about 12% of the total entries in encounters 1 and 2 fell into the shaded areas.

3.3.3 Conclusions Regarding Rotor Effects

The measurements reported in 3.3.1 and 3.3.2 above suggest that about 12 to 15% of the target-rotor position combinations consistently experience low two-way link reliability. In particular, when the target is aft of the helicopter, 25 to 50% of the rotor positions result in low link reliability.

Fortunately, there are two factors that alleviate this problem when the rotor is spinning. First, a TCAS tracker can be designed to be tolerant of a reduction in round reliability as high as 50% when the misses are uncorrelated from one update interval to the next. Secondly, the TCAS II surveillance algorithms generate more than one interrogation per track update period. When the target is Mode S equipped, the TCAS II surveillance system will reinterrogate up to five times in a single update interval. When the target is ATCRBS equipped, the TCAS II whisper-shout sequence provides approximately two interrogations per target per update period.

3.4 Received Power

As part of the airborne data gathering mission reported in 3.3.2, the power level of each reply was recorded by the AMF and used to make plots such as those shown in Fig. 3-4. The expected power, which was calculated as outlined in Table 3-1, is also plotted in Fig. 3.4. The power received on the top antenna is slightly less than the calculated value, and it appears that the helicopter antenna gain is only a few dB greater in the forward than the aft directions, despite the blockage by the rotor drive assembly in the aft direction. The bottom antenna gain is clearly better in the aft direction. This is to be expected given its aft location and its tilt towards the rear, as can be seen in Fig. 2-1.

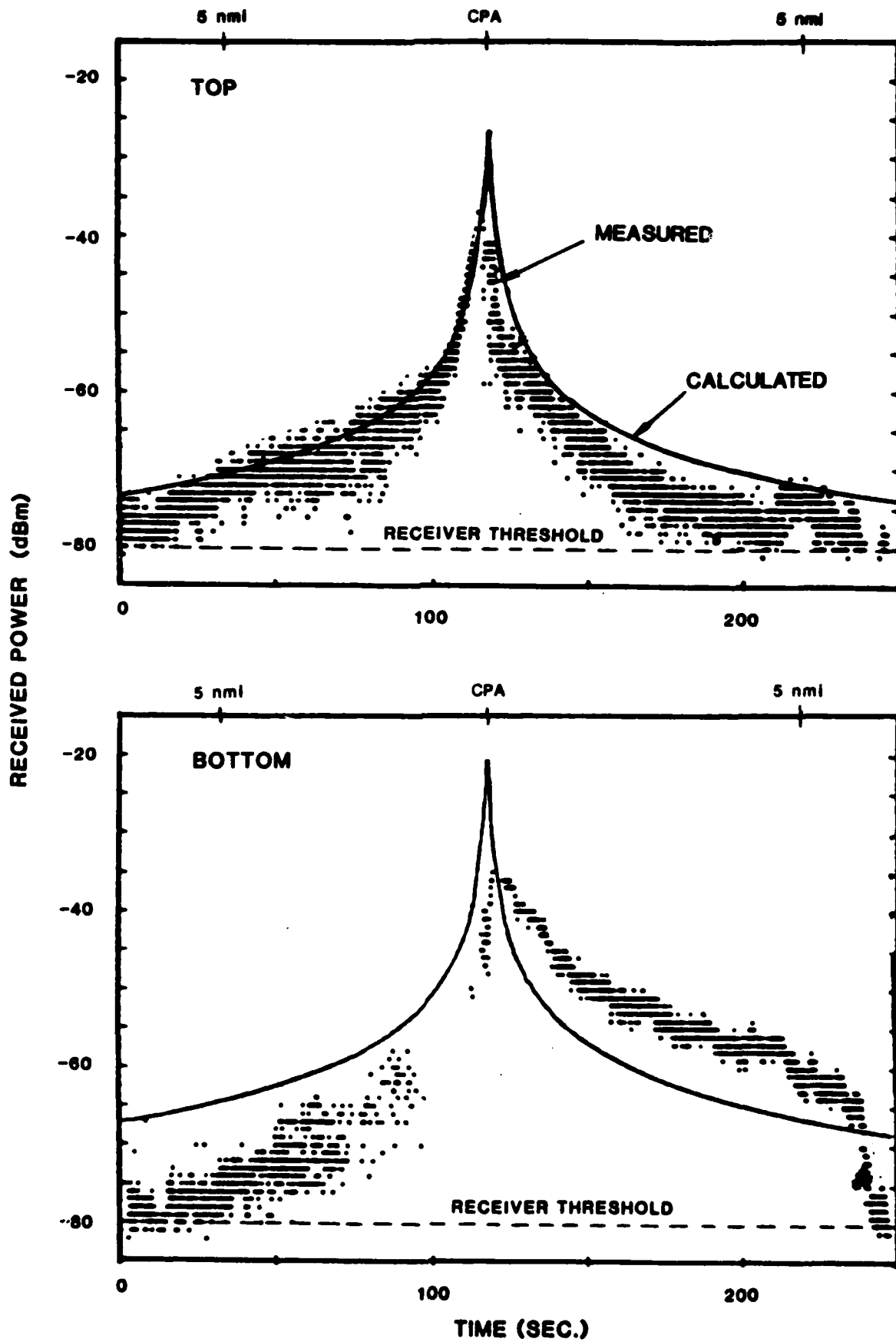

Fig. 3-4. Received power, encounter no. 1.

TABLE 3-1

CALCULATION OF RECEIVED POWER
AT THE HELICOPTER (FROM THE BONANZA)

1. Bonanza transmit power	54	dBm	54	dBm
2. Bonanza transmit cabling loss	2	dB	2	dB
3. Bonanza transmit antenna gain	0	dB	0	dB
4. Path loss (Bonanza to Helicopter)	98.5	dB	98.5	dB
5. Helicopter receive antenna gain	TOP-FORWARD -3	dB	BOTTOM 0	dB
6. Helicopter Receive cabling loss	TOP-FORWARD 7.5	dB	BOTTOM 4.5	dB
<hr/>				
7. Received power	TOP-FORWARD -57	dBm	BOTTOM -54	dBm

NOTES:

Item 4, free-space path loss
 $= 20 \log (4\pi R/\lambda)$ where R = range and λ = wavelength

Item 6, helicopter receive cabling loss. Normally this would be about 3 db or less. The AOA channel used for the top antenna in this installation uses a 3 dB power splitter, and the AMF has other losses not typical of operational equipment.

Item 7, received power is the sum of items 1, 3, and 5 minus the sum of items 2, 4, and 6.

3.5 Track Reliability

3.5.1 Mode S Track Reliability, 1000 ft Altitude

The 31 interrogations transmitted per second during each of the Mode S encounters reported in 3.3.2 were subsequently used as a data base input to a computer simulation that implements the Mode S tracking algorithms. The Mode S tracker normally operates in real time by re-interrogating aircraft as needed during a one-second update interval until a reply is received. The data base from the encounters was used to represent the replies that would have been received in response to the interrogations the tracker would have requested in real time.

The Mode S surveillance algorithm employs adaptive reinterrogation as illustrated in the following table:

<u>No. of Update Intervals since Last Success</u>	<u>Max. No. of Interrog. permitted per Update Interval</u>
1	5
2	4
3	3
4-10	2

This table may be interpreted as follows: If the track was successfully updated on the last update attempt, up to five Mode S interrogations will be transmitted to the target before giving up and coasting the track for one update interval (which is nominally one second). On the next update attempt only four Mode S interrogations will be transmitted before continuing the coast. The track is dropped after coasting for 10 update intervals. The table indicates that 26 consecutive failures are required before a Mode S track is dropped.

The results for encounter number one are shown in the track plot of Fig. 3-5. The target was in track 62 seconds prior to the time of closest approach. A total of four coasts occurred. Three of the coasts lasted for a single update interval, implying that from five to eight consecutive failures occurred. One coast lasted for two update intervals, implying 9 to 11 consecutive failures. Overall, an average of 1.6 interrogations were transmitted per track update.

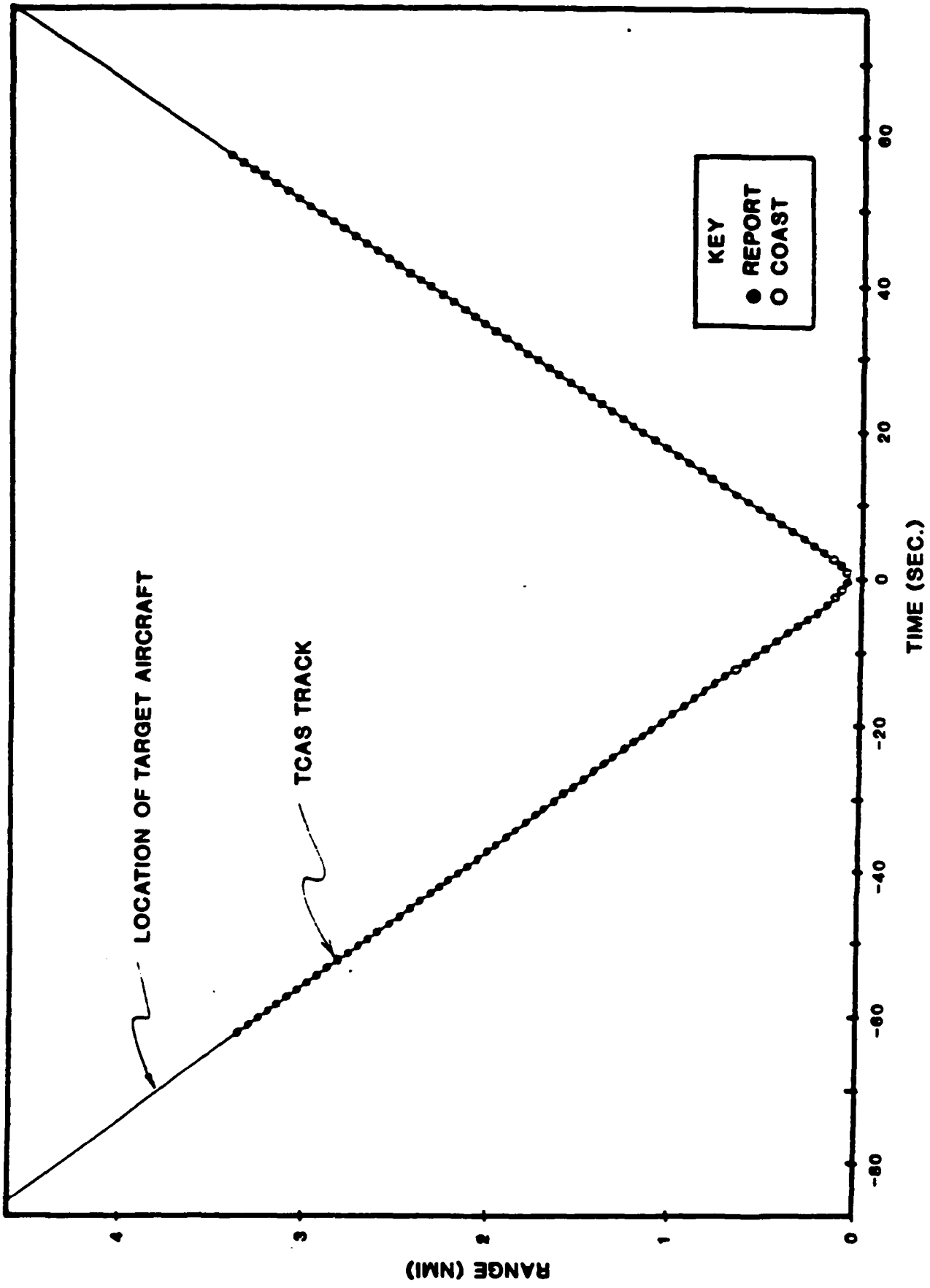

Fig. 3-5. Tracking performance from encounter no. 1.

Performance for the other encounters was similar, and is summarized below.

<u>Encounter</u>	<u>Duration of Track Prior to Closest Approach (sec.)</u>	<u>Average No. of Interrogations Required per Update</u>
1	62	1.6
2	61	2.1
3	57	1.9
4	57	1.7
5	61	1.5
6	56	1.9
7	62	1.5
8	58	1.5

Neither the degradation in link reliability for certain rotor positions in the diverging portion of the even-numbered encounters nor the effects of low-grazing angle multipath significantly affected the overall track reliability. This is because with Mode S surveillance, several attempts to receive a reply can be made each scan. The probability that one of the attempts will be successful is high, because the interrogations are completely uncorrelated with rotor position and also largely uncorrelated with the ground multipath environment which changes continually with the aircraft motion.

3.5.2 Mode S Track Reliability, 2000 ft Altitude

Ten additional flights were flown at an altitude of 2000 ft in the Boston area to evaluate overall tracking performance. The AMF was used in the Mode S interrogate/reply mode, using the top, forward-mounted antenna. The recorded AMF data obtained during these flights was also used for post-flight analysis of the performance of a representative TCAS tracker. In these flights, the encounter aircraft was able to fly both above and below the helicopter to assess the track reliability at negative depression angles. Overtaking, and crossing encounters were also flown. The characteristics of the encounters were as follows:

<u>Encounter</u>	<u>Type</u>	<u>Helicopter Altitude (ft)</u>	<u>Bonanza Altitude (ft)</u>
1	Head-on	2000	3000
2	Head-on	2000	2500
3	Head-on	2000	1500
4	Head-on	2000	1000
5	Head-on	2000	2500
6	Head-on	2000	1500
7	Overtaking	2000	2500
8	Overtaking	2000	1500
9	Crossing	2000	2500
10	Crossing	2000	1500

The results are shown in Figs. 3-6 through 3-8, where it can be seen that tracking performance was good while the aircraft were converging in all encounters. In every case, a track was established well before the point of closest approach. The figures begin approximately 50 seconds before the time of closest approach. In every case the track was established prior to the region plotted and was continued without a break through the point of closest approach.

In some cases, one or more coasts occurred. Examination of these coasts together with the track drops seen in some cases after the time of closest approach indicates a region of reduced link reliability behind and below the helicopter. This is caused by airframe shielding because the top antenna is mounted in front of the main rotor shaft. This shielding combines with the shielding of the intruder's bottom-mounted antenna by the intruder airframe to result in very deep fades in certain geometries.

Such fades also occur for TCAS installations in fixed-wing aircraft. It is not clear whether they are likely to be of more concern in the helicopter or the fixed-wing operational environment. Analysis of 15 mid-air collisions involving fixed-wing aircraft for which surveillance information was recorded [Ref. 10] shows that, although a large fraction (73%) of the fixed-wing collisions involved vertical movement, those collisions always involved aircraft approaching each other at vertical angles of less than 8 degrees from horizontal.

Although there is no available data on encounter angles in mid-air incidents involving helicopters, analysis of 187 helicopter mid-air incidents [Ref. 11] revealed that vertical movement (of unspecified rate) was reported in a somewhat smaller fraction (54%) of the incidents.

Concern is often expressed by helicopter pilots regarding other helicopters ascending or descending into them. Such collisions would also likely result in relatively large vertical angles. One might also hypothesize that as the horizontal speed of the aircraft decreases, it is more likely for the encounter angle to increase above 8 degrees, provided the absolute aircraft altitude is not a factor.

However, only three of the 187 incidents reported in Ref. 11 involved two helicopters. Because of this, and because helicopters usually fly very close to the ground, it can be expected that fixed-wing intruders will necessarily have very small vertical rates and will usually be located above the helicopter. These expectations would lead one to predict that encounters involving vertical angles of greater than 8 degrees are even more unlikely with helicopters than with fixed-wing aircraft.

Thus, the deep fades that occur for TCAS targets at negative depression angles below the helicopter do not seem to be of sufficient operational concern to warrant changes to the TCAS II surveillance characteristics.

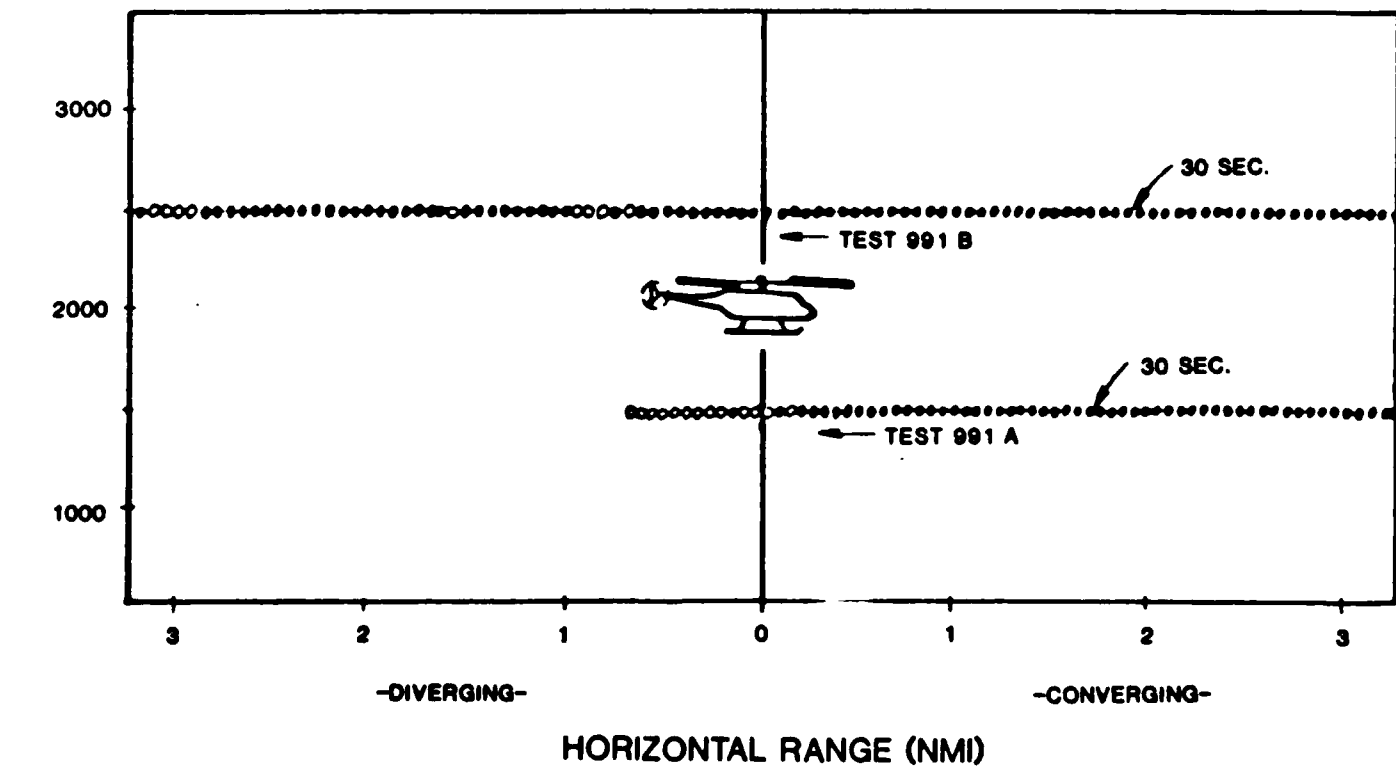
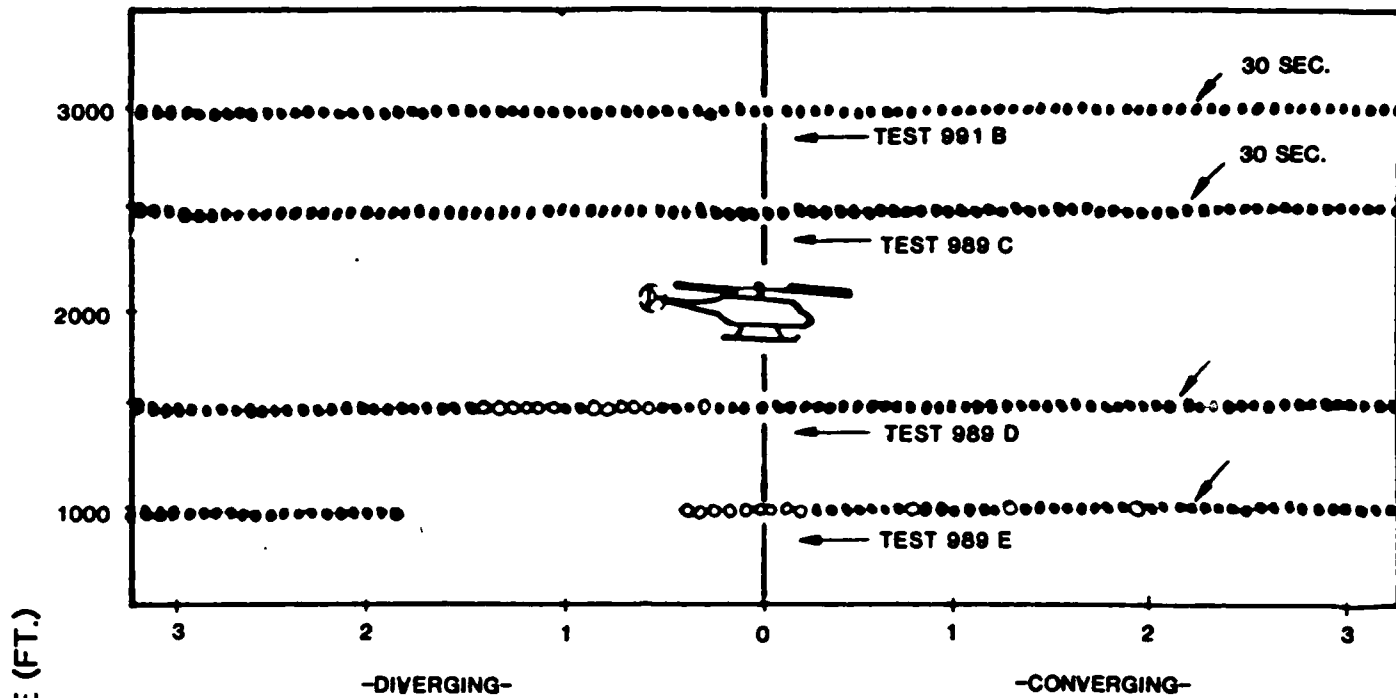

Fig. 3-6. Mode S surveillance performance in head-on encounters.

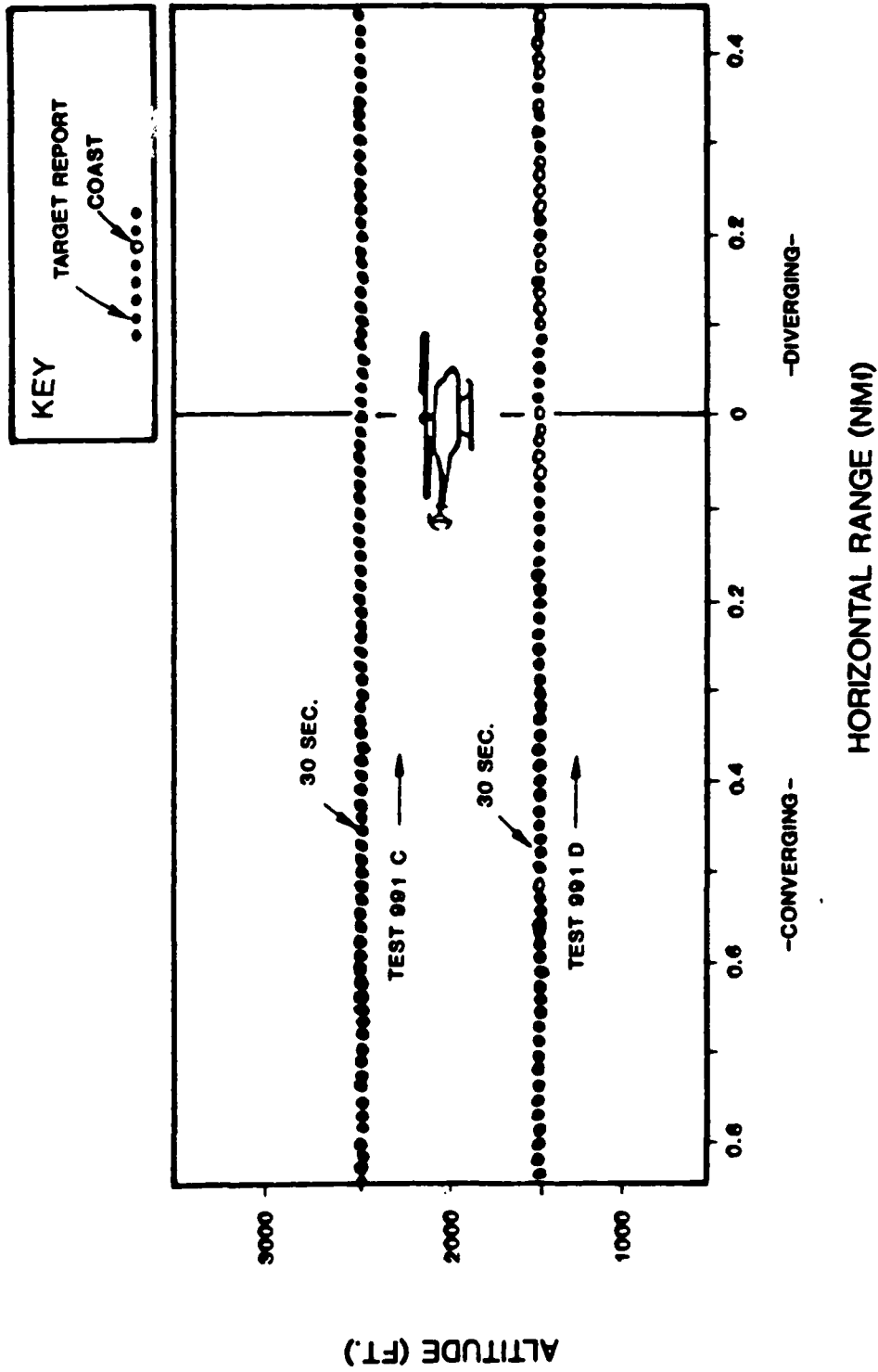

Fig. 3-7. Mode S surveillance performance in overtaking encounters.

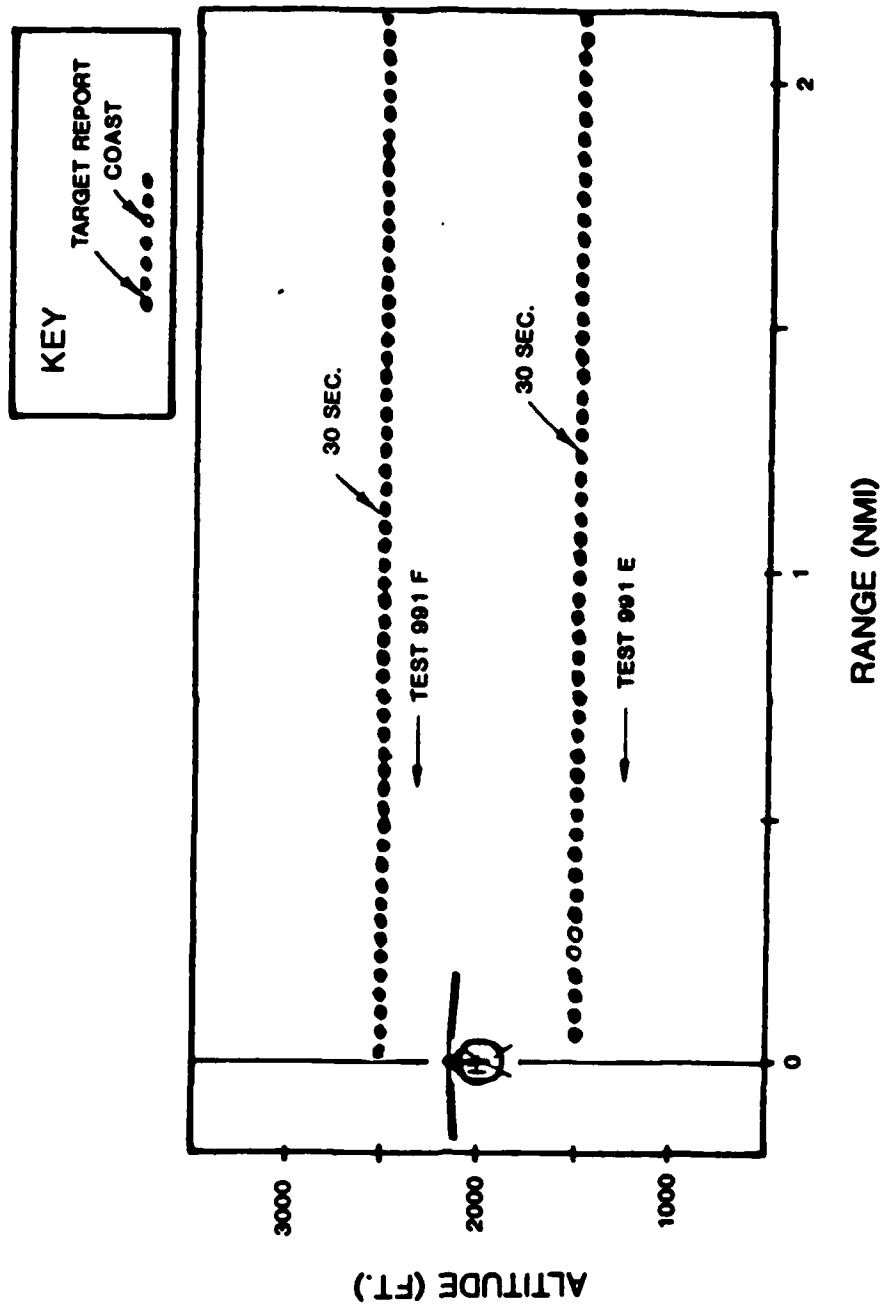

Fig. 3-8. Mode S surveillance performance in crossing encounters.

3.5.3 ATCRBS Track Reliability, N.Y.C. Airspace

On 29-30 January 1985 several flights were made in the New York City area using the Long Ranger helicopter equipped with the TCAS Experimental Unit to assess TCAS ATCRBS surveillance performance in a busy metropolitan area. Of special interest were the effects of high aircraft density, multipath as affected by the low altitudes typical of helicopters, water surfaces over which helicopters often fly, and reflections from buildings. The air-air surveillance measurements were conducted using ATCRBS targets of opportunity. The Ranger was based at Morristown, NJ. Data recordings were made while flying on the helicopter routes along the Hudson River and the East River, as well as during the flights to and from Morristown, NJ.

The TCAS Experimental Unit had the capability of recording all ATCRBS replies. Air-to-air surveillance was conducted in Mode C, using omnidirectional whisper-shout interrogations, with a top-forward AOA antenna and a bottom monopole antenna. The whisper-shout sequence is given in Fig. 3-9. The peak power from the top antenna was 200 watts (total radiated power), and the minimum interrogation power from the top antenna was 5 watts. The bottom antenna transmitted a four-step sequence ranging from a minimum interrogation power of 1.6 W to a maximum interrogation power of 6.3 W. It should be noted that this is not the standard whisper-shout sequence specified for TCAS II in Ref. 4. The sequence of Fig. 3-9 was used to investigate the possibility of using a simpler whisper-shout sequence with an attenuator resolution of 2 dB and a total of 8 attenuation values, rather than the sequence with 32 attenuation values and 1-dB resolution required for full TCAS II equipment.

Surveillance performance was evaluated by post-mission analysis of close encounters. There were 15 encounters in a period of 58 minutes for which a target aircraft came within 1.5 nmi in range while being within ± 900 ft in altitude. The TCAS performance that resulted from these 15 encounters is given in Fig. 3-10. Figure 3-10 shows, for each encounter, the track history in the 50-second period leading up to the point of closest approach.

Unlike the Mode S tracker, the TCAS II ATCRBS tracker does not have the ability to adaptively reinterrogate targets during a single track update period. Typically two and occasionally three replies are received from a target during a single update period as a result of the overlap in the whisper-shout interrogation bins. If no reply can be correlated with a track following the transmission of the whisper-shout sequence, the track is coasted.

Fig. 3-10 does not identify track coasts. It only distinguishes between intervals for which the target is in track or not in track. TCAS II starts ATCRBS tracks after correlating replies have been received from the target on four update periods, and it drops ATCRBS tracks after six consecutive coasts. (TCAS II can coast Mode S tracks longer [10 update periods] before dropping because the Mode S discrete address makes it impossible to associate a reply with the wrong track.)

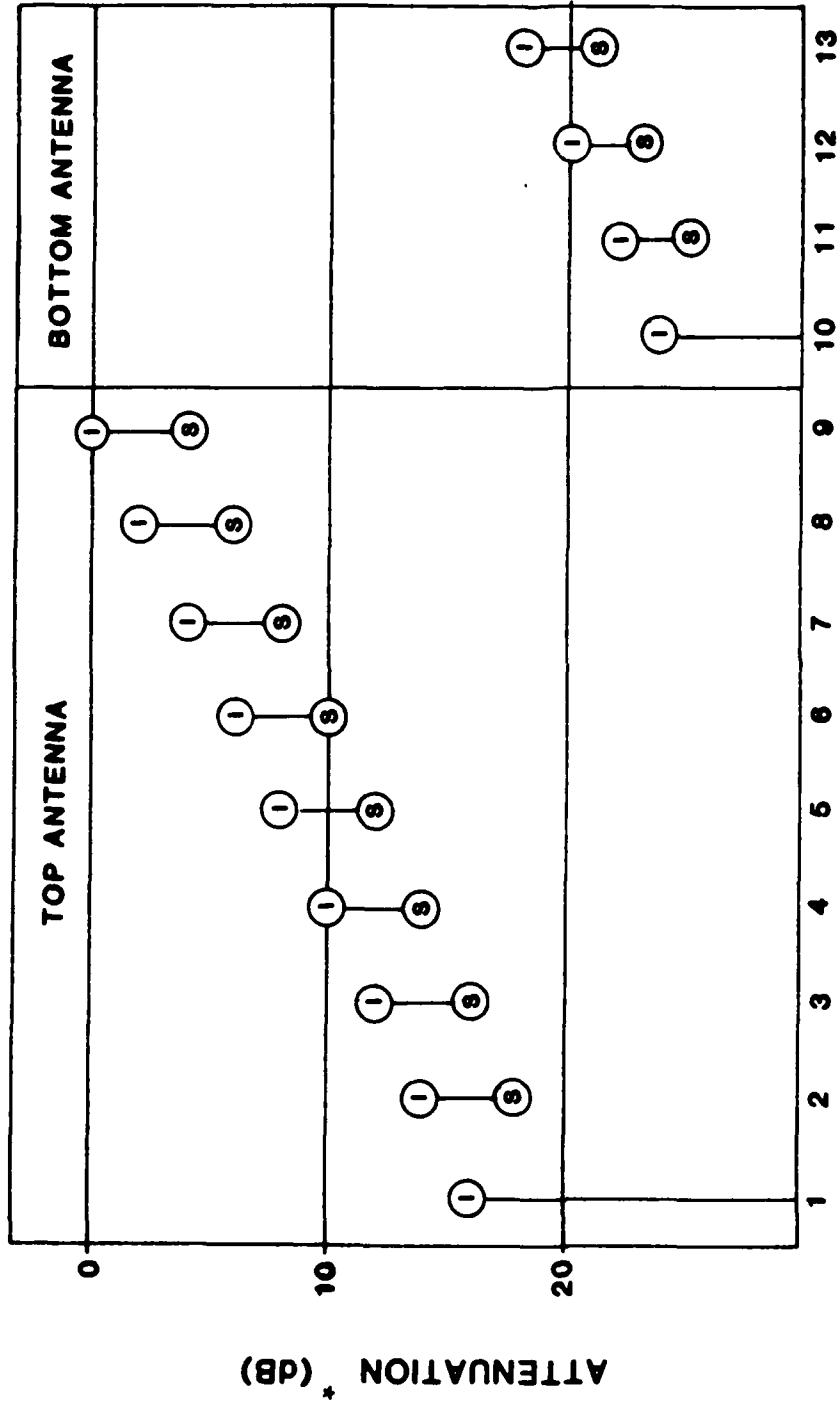

INTERROGATION NUMBER



* WHEN ATTENUATION = 0, TOTAL RADIATED POWER = 200 WATTS.
TOP AOA ANTENNA, AND 400 WATTS, BOTTOM MONOPOLE ANTENNA.

Fig. 3-9. Whisper-shout sequence used in the helicopter measurements in New York.

Target in track denoted by ●
Not in track denoted by ·

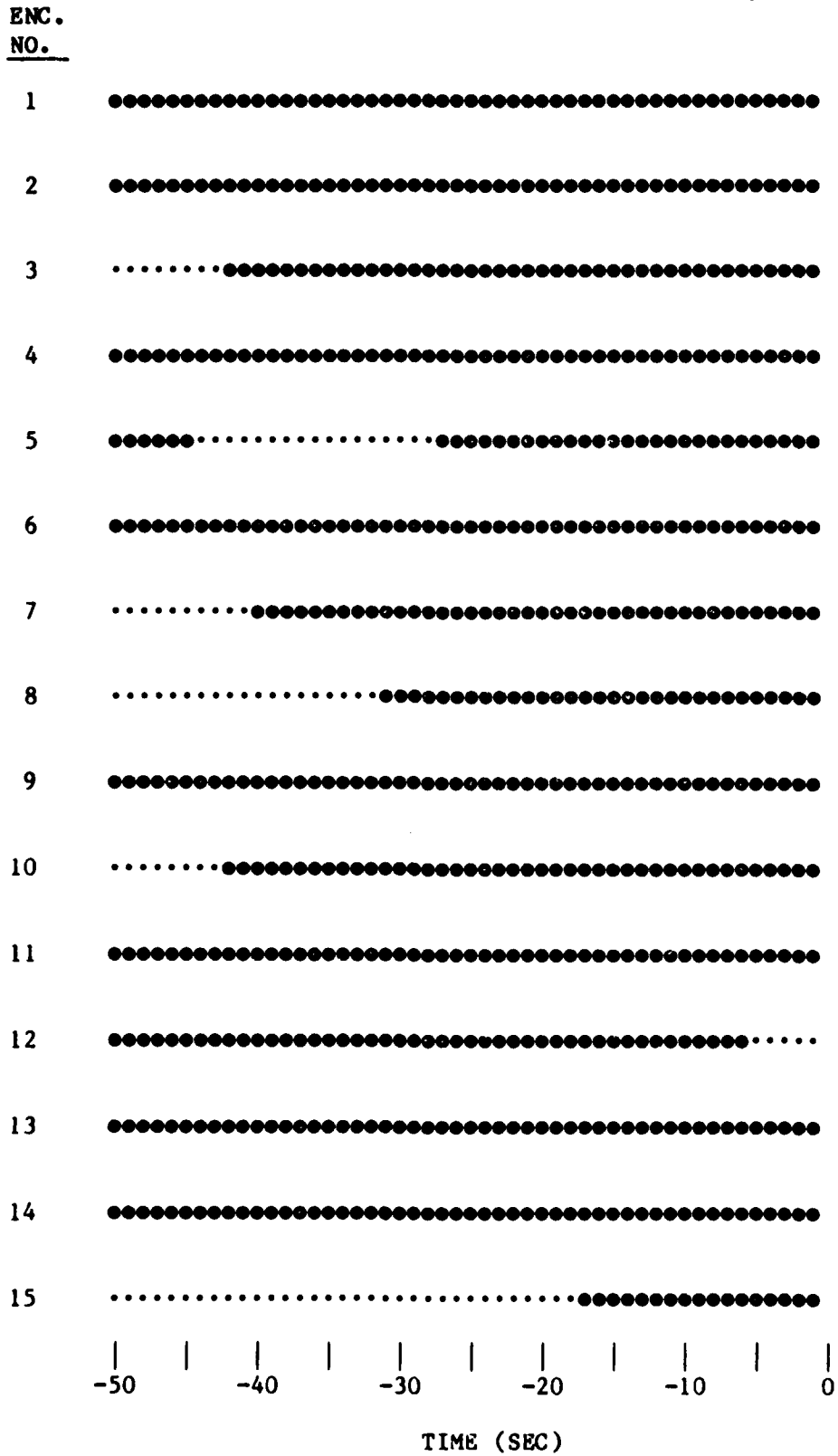

Fig. 3-10. TCAS air-air surveillance during 15 close encounters in New York.

In ten of the encounters, the target was in track 50 seconds before the point of closest approach. In only one of the encounters (number 15) was the track started later than 25 seconds before the point of closest approach. In eight of the encounters, the target was in track for the entire 50 seconds preceding the time of closest approach. Two encounters (number five and number 12) experienced track drops within the 50-second period plotted. In number 12, the track was dropped five seconds before the point of closest approach.

The overall reliability, or percentage of updates for which the target was in track, was 87%. This was somewhat lower than would be expected for TCAS II operating in a small fixed-wing aircraft in a similar airspace. Detailed examination of the data during the 15 close encounters showed that the probability of track was reduced by two new factors in addition to the previously-discussed multipath, airframe blockage, and reflections from the main rotor and its drive assembly.

1) The lowest whisper-shout level in the top-antenna sequence was often overloaded. Normally, the top-antenna sequence for omnidirectional TCAS II extends down to a minimum interrogation power level of 0.8 watt. The 5-W minimum power interrogation used in the sequence of Fig. 3-9 elicited responses from a much larger fraction of the aircraft population than did any of the other whisper-shout interrogations in the sequence. This would appear to reflect the fact that helicopters typically operate in closer proximity to each other than do fixed-wing aircraft. Near-by aircraft receive the TCAS interrogations with less free-space path attenuation than do distant aircraft and are therefore more likely to detect the lowest-power whisper-shout interrogations. When more than two aircraft reply to a single whisper-shout interrogation, the ability of the TCAS reply processor to degarble the overlapping replies diminishes rapidly.

2) A number of instances were seen in which replies were not received because they were overlapped by stronger replies that temporarily raised the minimum triggering level (MTL). Normally, in TCAS II the MTL is raised to within 9 dB of the level of each incoming reply to help discriminate against reflections of the signal that are 10 dB or more below the direct signal level. This Dynamic Minimum Triggering Level or "DMTL" is held for the duration of the reply, after which the MTL is restored to its nominal (more sensitive) value. Low-amplitude replies to TCAS II interrogations are normally not lost when the MTL is raised because the whisper-shout process tends to sort out targets such that all replies to a given whisper-shout interrogation are received at approximately the same power level.

Two factors were apparently responsible for the increased incidence of "DMTL Capture" observed in the data from this flight test. First, the receipt of multiple replies in response to the lowest-power whisper-shout interrogation increased the probability of simultaneous overlapping replies.

Second, the close ranges of the targets increased the probability that two targets in the same range-garble bin would be received with widely varying signal strengths. For example, a pair of targets at ranges of 0.1 and 1.0 nmi would synchronously garble each other if they both replied to the lowest-power whisper-shout interrogation. Yet, if they both transmitted the same power, the signal from 1 nmi would be 20 dB weaker at the TCAS receiver than that from 0.1 nmi because of the difference in path loss, and the weaker signal would be lost because of DMTL. If these two aircraft had the same 0.9-nmi differential range from the TCAS aircraft, but were at ranges of say 9.1 and 10.0 nmi, the path loss difference would be only 0.4 dB.

Both of these problems can best be eliminated by extending the whisper-shout sequence (so that it continues to sort interrogations and replies into 6-dB or smaller bins) down to interrogation power levels of less than 1 watt. It is not advisable to eliminate DMTL. Dynamic thresholding is particularly important at low altitudes because, as noted in Section 3.2, the signal-to-multipath ratio over water at low altitudes (and corresponding low grazing angles) will seldom exceed 10 dB.

For all subsequent helicopter flights after examination of the data from the New York flight, the whisper-shout sequence was extended at the low end, keeping the same 2 dB pattern. The total number of interrogations was 16, with the lowest level being 30 dB below the peak. Although a detailed analysis of tracking performance was not attempted after the New York flights, the qualitative response of the pilots and observers in all subsequent flights along the Boston helicopter routes would indicate that the ATRBS tracker was more than 90% reliable. There were no reported instances of aircraft that failed to appear on the cockpit display after being visually detected within the range and altitude limits that would warrant a traffic advisory.

4. ANGLE-OF-ARRIVAL (AOA) PERFORMANCE

This section describes the results of measurements of bearing estimation performance made with the Lincoln Laboratory TEU installed in the Long Ranger helicopter. The implementation of the TEU AOA receiver and digital processor subsystem is described in detail in Ref. 12. A mathematical analysis of the AOA antenna and a detailed description of the AOA RF subsystem is included in Appendix A of this document. This section describes the techniques used for evaluating the AOA performance and discusses the accuracy, stability, and installation repeatability of the AOA technique. The operational acceptability of the bearing estimates obtained from the AOA system in real time was also investigated in the series of test missions flown by 12 subject pilots as reported separately in Ref. 8.

A number of techniques were investigated for measuring the accuracy of the AOA system on the helicopter, both on the ground and in the air. The main difficulties with such a measurement are a) the determination of the reference or "actual" bearing angle of other aircraft, and b) developing a method to record and accurately correlate the actual angle with the angle derived by the AOA system. These measurements were complicated by the fact that the helicopter was not equipped with instruments that would allow its own bearing to be recorded automatically and accurately.

A semi-automatic technique for determining actual target bearing was developed using an optical sighting device attached to a digital shaft encoder. In this section the results obtained with this encoded optical sight are compared to results using several other techniques. The optical sight was first used to measure the bearing of a stationary transponder as the helicopter hovered and subsequently used to measure the bearing of a target aircraft in controlled airborne encounters.

4.1 AOA Calibration Measurements

The TEU direction finding system is designed so that it can be removed from one aircraft and installed in another aircraft without recalibrating the AOA offset or bias angle, provided a) the physical antenna alignment on the airframe is accurate, b) the two RF cables from the antenna beam-forming assembly to the TEU receiver input ports are phase-matched, and c) there are no physical obstructions on the airframe causing significant reflections that may introduce an additional bias into the direction-finding system.

The first two of these conditions are easily met in a new airframe installation. The third condition is easily met on large aircraft. It is more difficult to satisfy on small aircraft, and it is particularly questionable on a helicopter. For this reason, an initial calibration test was performed to determine whether the helicopter airframe configuration significantly affected the AOA bias offset.

The direction-finding antennas consist of arrays of four monopoles arranged in a quarter-wavelength square pattern as illustrated in Fig. A-1 of Appendix A. As noted in Section 2.5, two of these arrays, with their associated beam-forming assemblies, were installed with precise alignment on

the top of the Jet Ranger. One was forward of the main rotor and the other was aft of the rotor and the engine exhaust ports. Care was taken to assure that the antenna cables were phase matched to within 3 degrees.

The initial calibration of the antenna on the helicopter was performed on the ground. A test transponder with a directional horn antenna was set up at a fixed location about 3000 ft from the helicopter. The bias offset angle, which is inserted into the TEU as a software parameter, was the same value that was used for the TEU in its previous installation in a Cessna 421 aircraft. The helicopter was visually aligned with its major axis in the direction of the test transponder and then manually rotated in 30-degree steps as determined by the magnetic compass in the cockpit. It is estimated that the helicopter compass position at each step was accurate to within ± 3 degrees.

The results of this measurement for the forward-mounted antenna are plotted in Fig. 4-1. This figure shows, for two runs, the TEU's displayed target bearing angle plotted versus the magnetic bearing of the target. It is clear from the plot that there is a residual positive bias in the data. The error in the head-on position (actual bearing of 0 degrees) was 18 degrees in the first run and 17 in the second. The overall statistics of the data were as follows:

mean error	= 14 degrees
RMS error	= 23 degrees
Standard deviation	= 18 degrees

The mean error of 14 degrees was small enough relative to the limited accuracy of this preliminary measurement to not warrant any change to the bias offset value prior to the subsequent flight tests. The 18-degree standard deviation of the bearing error is significantly larger than the comparable performance as determined on small fixed-wing aircraft (approximately 10 degrees).

4.2 Airborne Measurements

4.2.1 General Considerations

The ground calibration procedure reported above has certain limitations. Although an open and unobstructed location was selected for this measurement, it is possible that reflections from the ground might affect the result. It is also very time consuming to make manual measurements of this type with sufficient angular resolution to identify detailed characteristics of the AOA transfer function.

The ground test also did not include the effects of rotor motion. The AOA estimation process in the TEU is dynamic in the sense that a software tracker is employed to estimate the target bearing on the basis of current and previous bearing measurements. Since the rotor motion will have a significant, but random, affect on the bearing measurement from one surveillance update period to the next, it was important to develop a technique for making accurate bearing calibration measurements in flight.

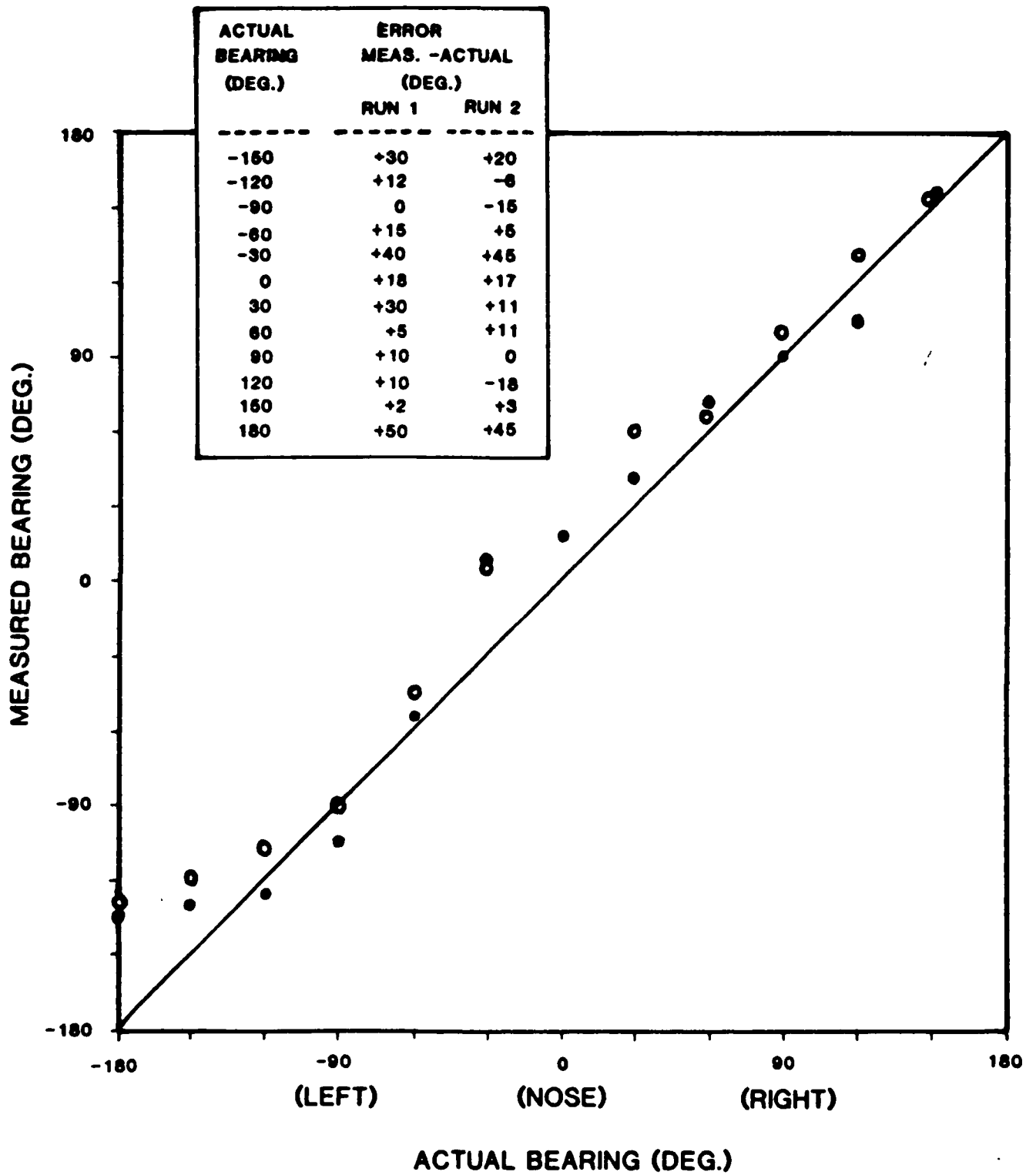

Fig. 4-1. Bearing calibration check, on the ground.

One of the difficulties of flight test measurements is that of conveniently establishing and recording bearing truth. In the ground measurement there was adequate time to establish an initial manual alignment of the helicopter and to manually record the compass reading and AOA estimate at each of the 30-degree intervals of rotation. In flight, it is necessary to obtain instantaneous recordings of the true target bearing and to unambiguously correlate these to instantaneous recordings of the AOA estimate. Because helicopters often experience large crab angles and undergo rapid heading changes, it is impractical to manually record all of the necessary information to establish bearing truth.

Airborne measurements of AOA performance have been made previously at Lincoln Laboratory on fixed-wing aircraft. In this work, a ground based secondary surveillance radar (MODSEF) was used to monitor the positions of both aircraft, while the heading of the TCAS aircraft was measured on-board by a directional gyro-compass. The gyro-compass measurements were interfaced to a Mode S transponder, and then transmitted to the ground on the Mode S data link. It was not practical to employ this technique in the helicopter TCAS development since MODSEF was not operational during this time period.

Three distinct techniques were employed for making airborne bearing estimates with the helicopter. The following sections describe the techniques used and, more importantly, the results obtained with each of these techniques. In general, the bearing calibrations obtained from the three techniques were comparable. The main differences were practical, related to issues such as ease of use and completeness of coverage.

4.2.2 Bilateration to Determine Actual Bearing

The earliest airborne measurements of AOA performance in the helicopter made use of a bilateration technique to determine the location of the helicopter relative to two fixed transponders mounted on towers. The heading of the helicopter was determined from the magnetic compass in the cockpit and this information together with the TCAS tracks of the two fixed transponders was used to accurately calculate the actual bearings of the two transponders at each instant.

The helicopter was flown along an oval path based on Hanscom Field Runway 29. The altitude was 400 ft above ground level when over the runway, which is approximately coaltitude with the two fixed transponders (both of which were on hilltops). Figure 4-2 shows the calculated flight path and the locations of the transponders at MODSEF and the Billerica water tower. Heading was determined manually, and was recorded only during the two linear segments of each oval. Two ovals were flown. During the linear segments, the helicopter flew straight and level. During one westbound pass over the runway, the MODSEF transponder varied over about 120° in bearing on the left side of the aircraft while the Billerica transponder varied over about 30°.

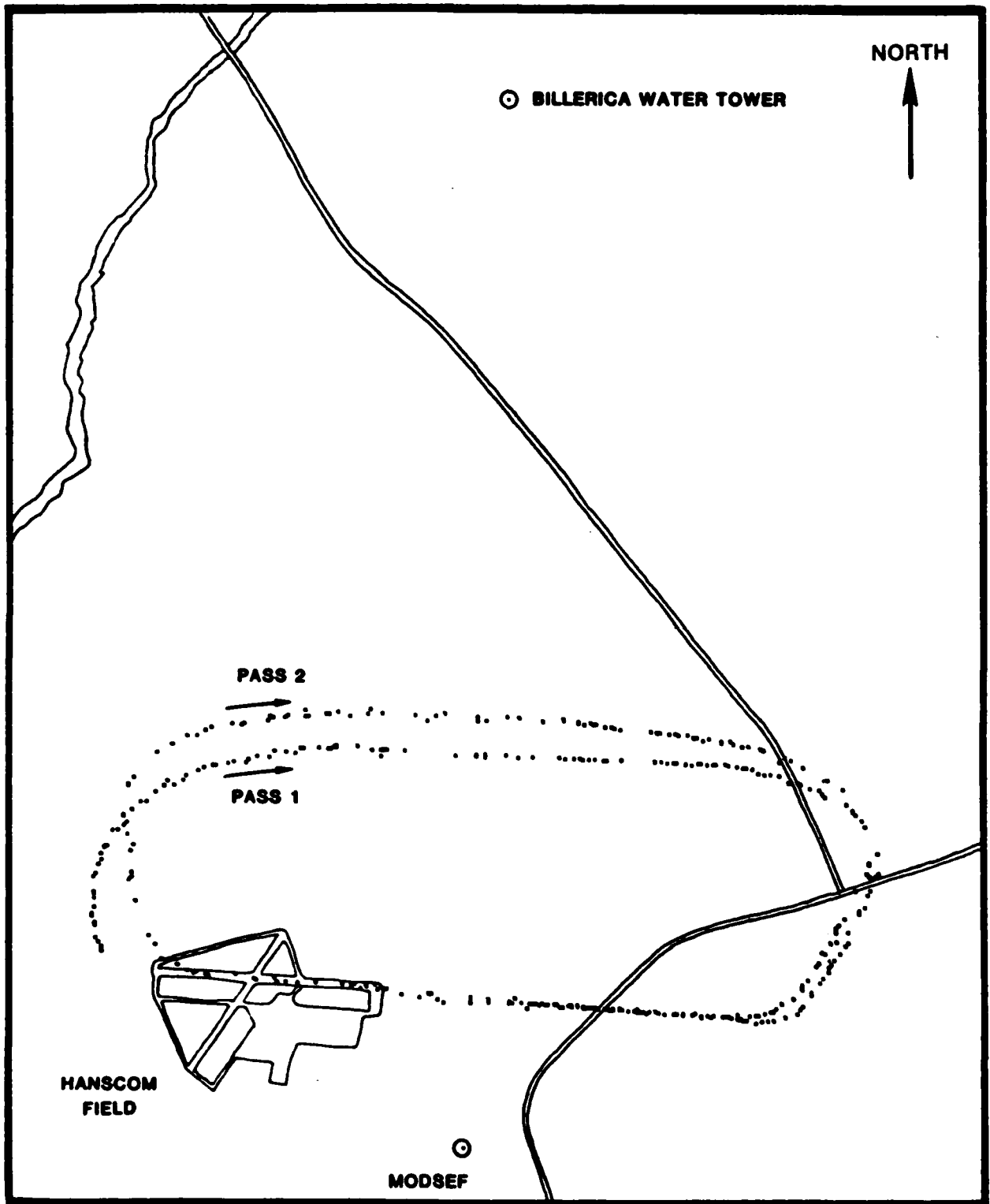

Fig. 4-2. Flight path.

100198

Results are given in Fig. 4-3, separately for the two westbound segments. Figure 4-4 contains comparable results from the two eastbound segments, and Fig. 4-5 gives the composite transfer function from all four segments. Comparison of the individual segments indicates that the main AOA performance characteristics exhibit reasonable repeatability.

The composite transfer function (which was derived from about 15 minutes of flight) shows AOA performance over more than 180°. The composite transfer function reveals significant ripples. The transfer function is not monotonic. These ripples are considerably larger than the superimposed scatter among individual replies. Such scatter may be expected to result from, among other causes, the motion of the rotor. This observation leads to the conclusion that it would not be possible to achieve a significant improvement in AOA accuracy by synchronizing interrogations to rotor position.

4.2.3 Windscreen Calibration Marks to Determine Actual Bearing

The use of bilateration to determine actual bearing has several limitations. It can only be applied in a small region of airspace located between fixed transponders on the ground, and at altitudes close to those of the test transponders. If there are only two test transponders available, it is difficult to fly a path between the transponders that allows true bearing to be measured over a full 360 degrees. In particular, the important regions directly fore and aft of the helicopter are difficult to assess with this technique.

Because of these limitations and because it is not possible to use bilateration to determine the bearing of an airborne target transponder, it was decided to develop a technique for visually determining the actual bearing of a target aircraft from the helicopter cockpit. Visual techniques for assessing bearing are well matched to the intended operational use of helicopter TCAS as a traffic advisory system. The basic requirement on TCAS AOA accuracy is that it should be sufficient to avoid disagreement between what a pilot sees and what appears on the display.

Two techniques were developed that made use of an optical sighting system in the cockpit. The first of these made use of a set of calibration marks (in the form of narrow strips of black tape) placed on the helicopter windscreen. These were used in conjunction with a fixed sighting point consisting of a small metal rod, by which an observer could visually determine the bearing of a target aircraft. The rod was located just in front of the observer's normal head position, so that the tape marks could be conveniently sighted between the rod and the target. The windscreen marks were located every 10° over a range of azimuths 60° relative to "straight ahead".

Airborne measurements using this technique were conducted using a Beechcraft Bonanza as the target aircraft. The Bonanza and the helicopter were flown about a mile apart in essentially the same direction. The AOA performance results, which were obtained in 10° steps, are plotted in Fig. 4-6. Each point plotted is the time average of the AOA measurements

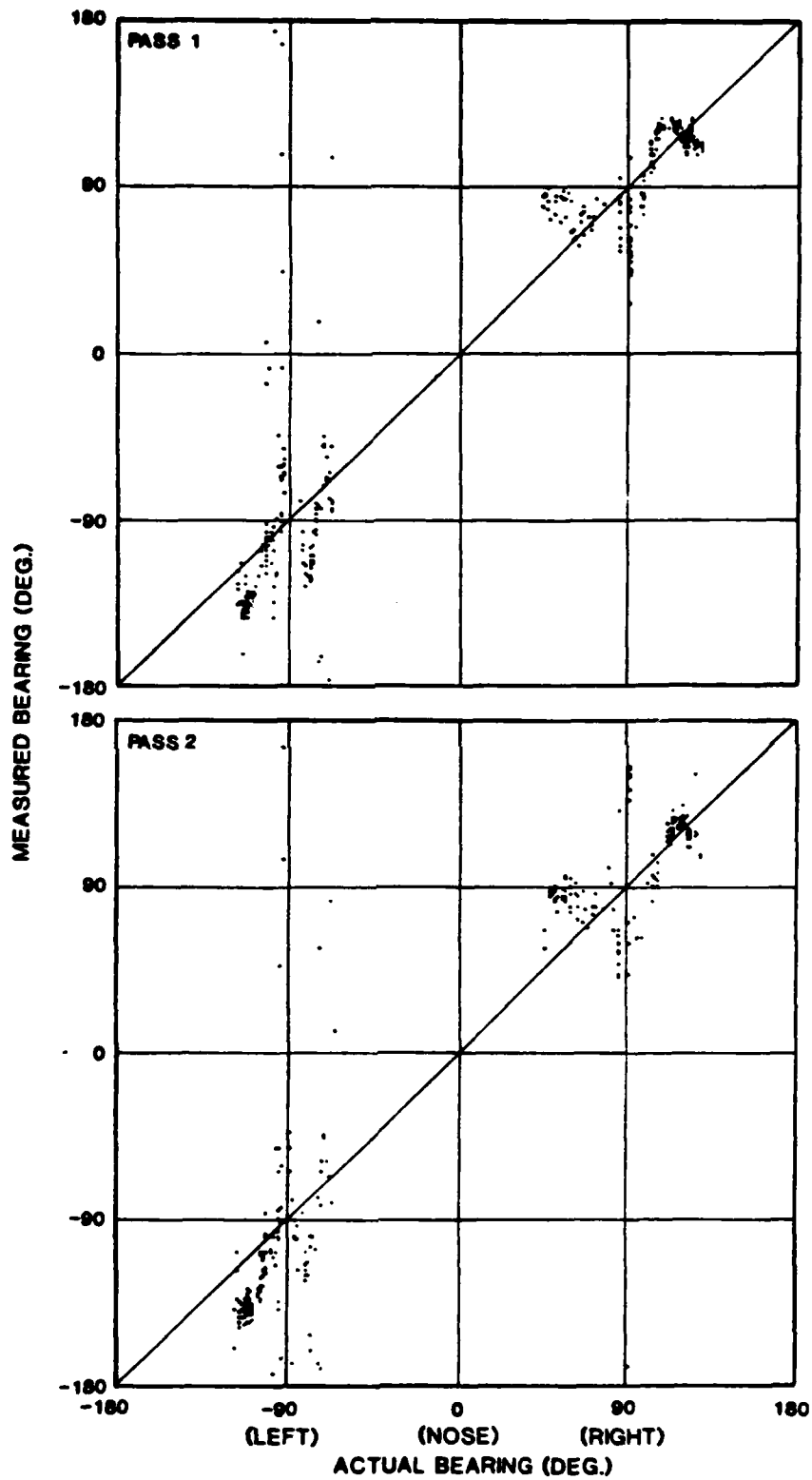

Fig. 4-3. AOA transfer function, two westbound passes.

100300

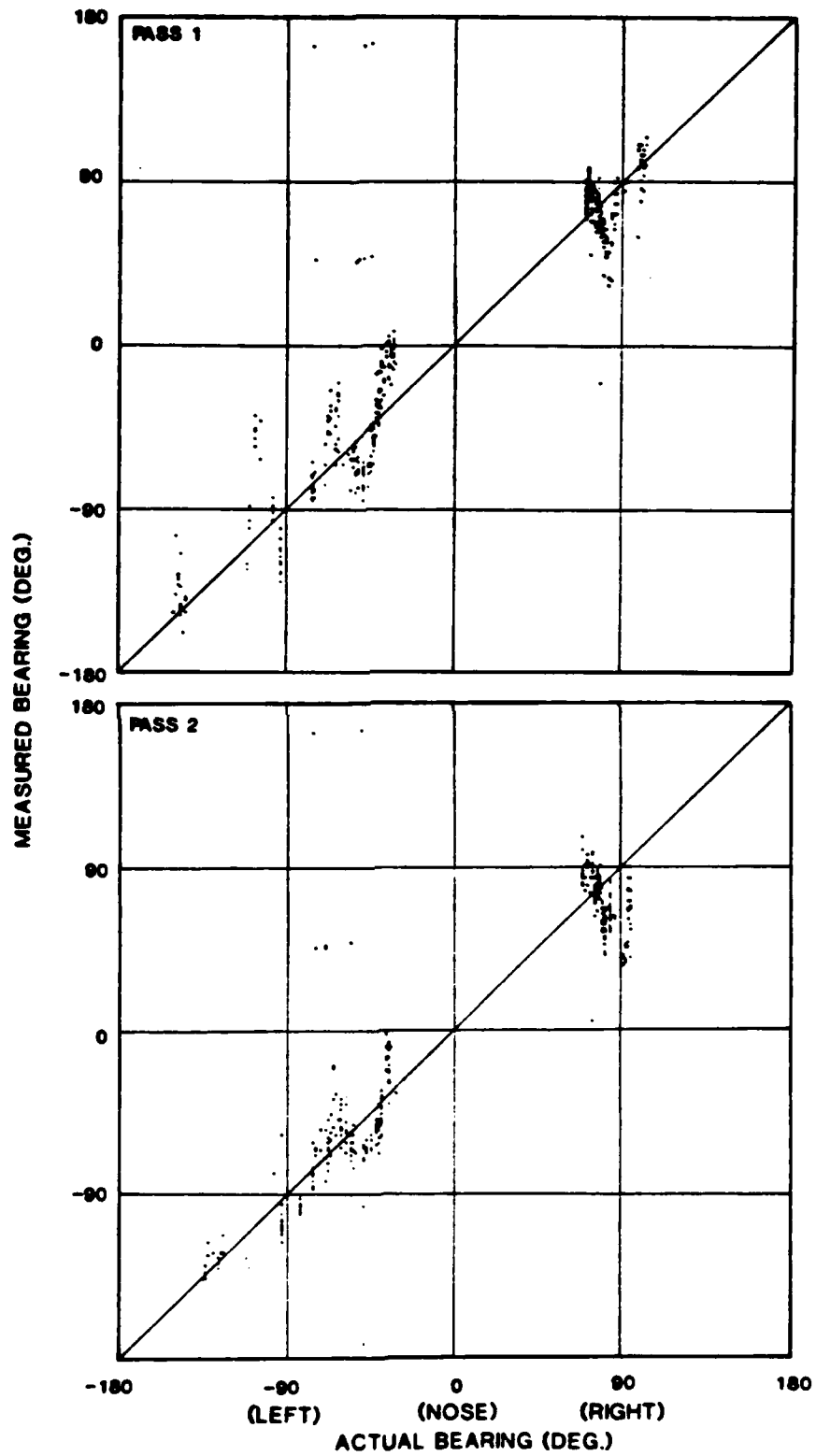

Fig. 4-4. AOA transfer function, two eastbound passes.

100301

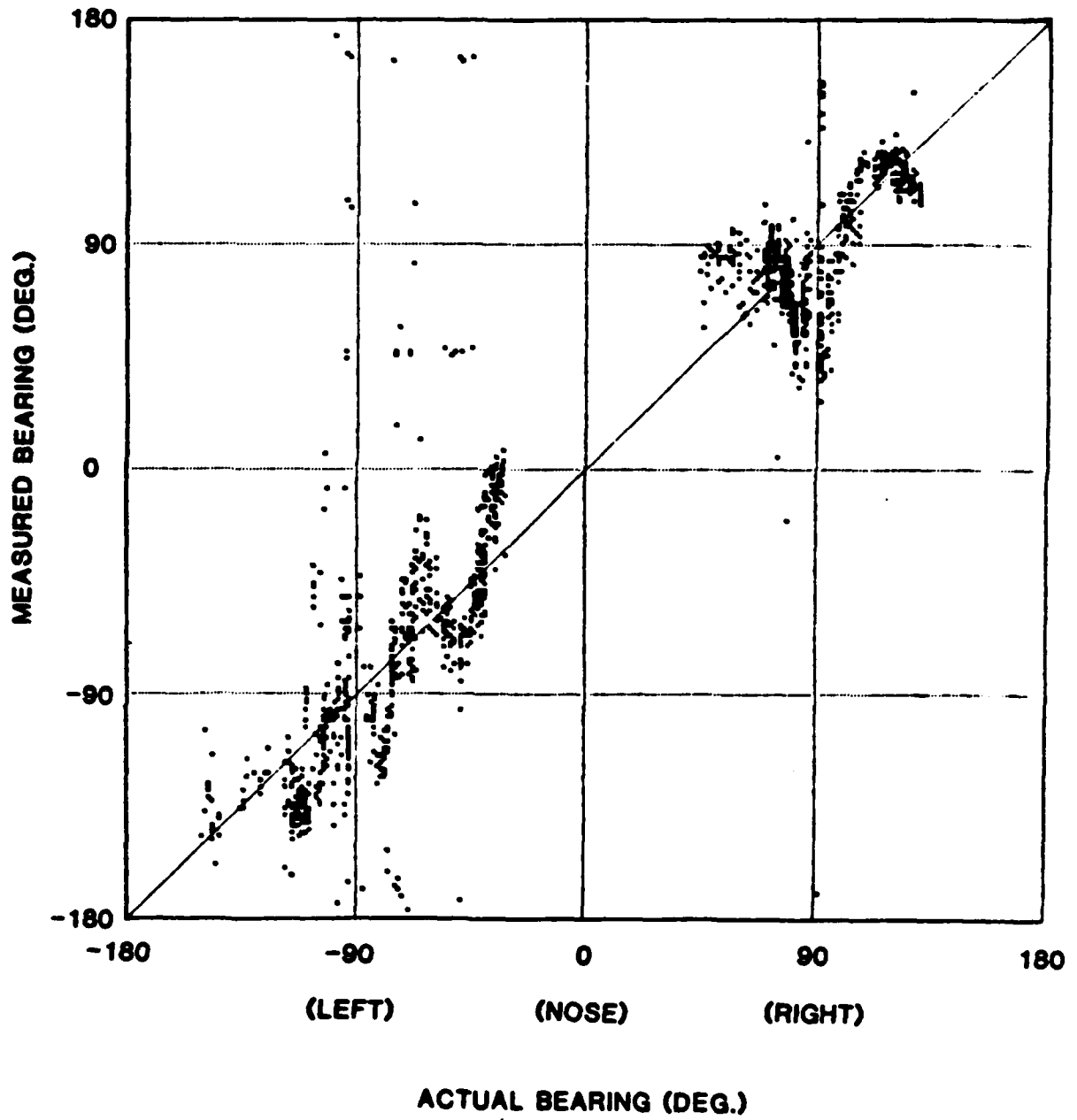
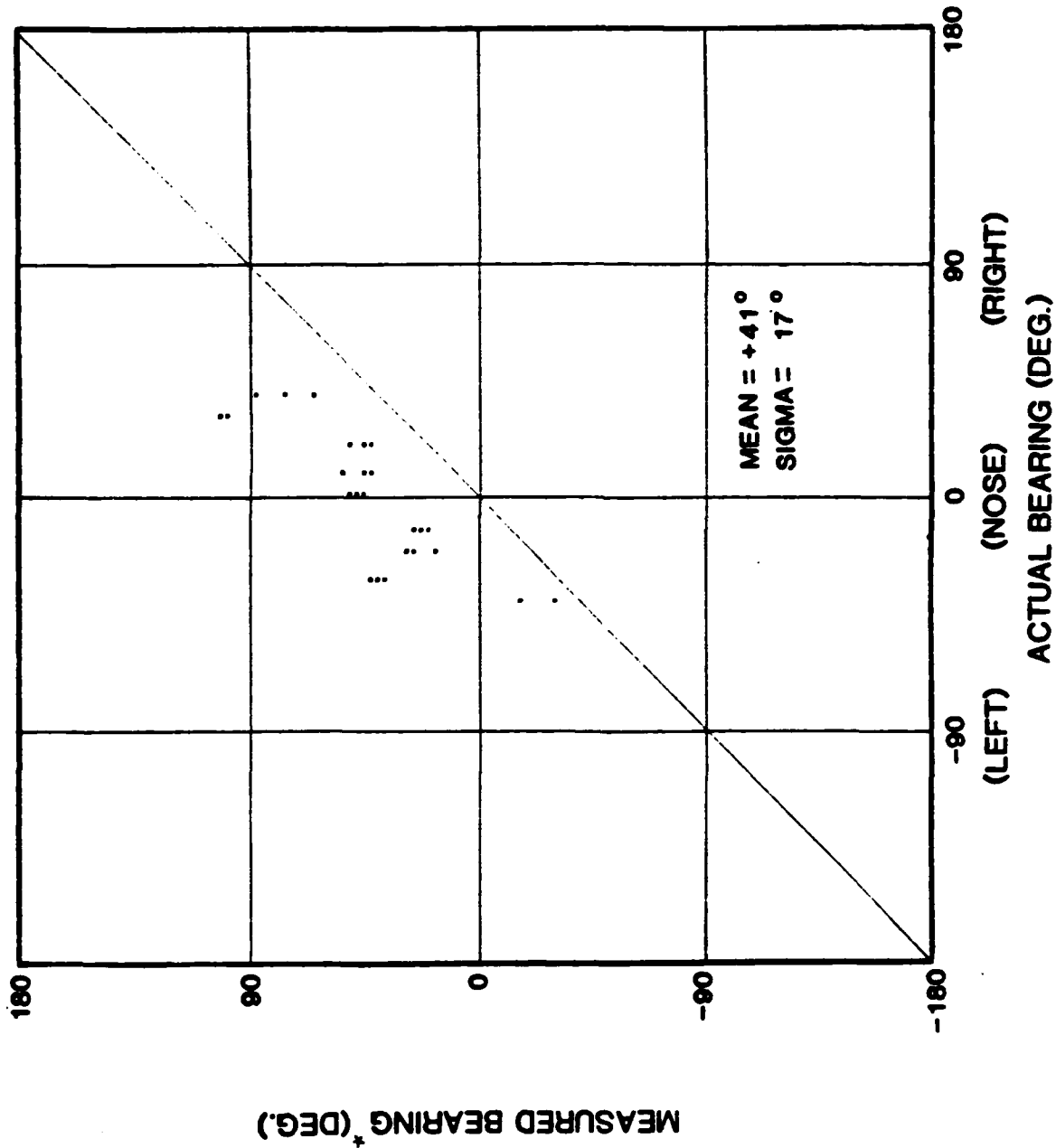

Fig. 4-5. AOA transfer function measured airborne.



100535

* Note: Time average values are shown.

Fig. 4-6. Airborne AOA measurements using windscreen sighting system.

during the time period (approximately 5 seconds) in which the target was held at a particular value of bearing. The mean and standard deviation of the bearing error were computed from these points, and are marked in the figure.

The results in Fig. 4-6 indicate that the standard deviation of AOA errors was significant in the forward quadrant. It was known previously that errors of this magnitude occur in both the left and right quadrants. Furthermore it may be seen that these errors were, for the most part, repeatable from day to day in the three days of measurements plotted (shown as three points at each value of actual bearing).

4.2.4 Shaft Encoder Sight to Determine Actual Bearing

A refinement to the airborne AOA assessment technique described in Section 4.2.3 was made by installing a shaft encoder sighting system in the helicopter in place of the windscreen sighting system. To use this system, an operator aimed an azimuthal sight, consisting of two small rods several inches apart, at a target aircraft. The sight was attached to a shaft encoder which digitized the bearing angle. This digital information was electrically input to the TEU, where it was recorded on the TEU tape. This system had several advantages over the windscreen sighting system. Whereas the windscreen marks had a spacing of 10° , the shaft encoder system enabled bearing measurements to be made between the 10° points with high resolution. Also the fact that the shaft encoder data was recorded directly on the same tape containing the AOA data led to a significant benefit in data reduction.

An initial assessment of AOA airborne accuracy using the shaft encoder system was undertaken by flying the Bonanza along with the helicopter in essentially the same direction. The Bonanza was in front, about 1 mile away, and drifted slowly from side to side as seen from the helicopter. Thus, the actual bearing, which was continuously monitored by the shaft encoder system, varied over about $\pm 60^\circ$. Sample results from this test are plotted in Fig. 4-7.

These data points were obtained in one pass of the target aircraft from left to right in front of the TCAS aircraft. These results were consistent with the data obtained previously in mean error and degree of scatter about the mean. These results indicated that the ripple previously seen in the transfer function for the right and left quadrants also appears in the forward quadrant.

4.2.5 Shaft Encoder Sight Measurements Hovering Just Above Ground

The shaft encoder sighting system made it possible to conduct a full 360° AOA assessment hovering just above the ground, and at a much greater angular resolution than previously obtained.

The technique was as follows. The helicopter, located on Hanscom Field, was sited at a distance of about 1500 ft from a fixed target transponder at the Lincoln Laboratory Flight Facility. The transponder used a horn antenna, about 15 ft above the ground and aimed at the helicopter which was in clear

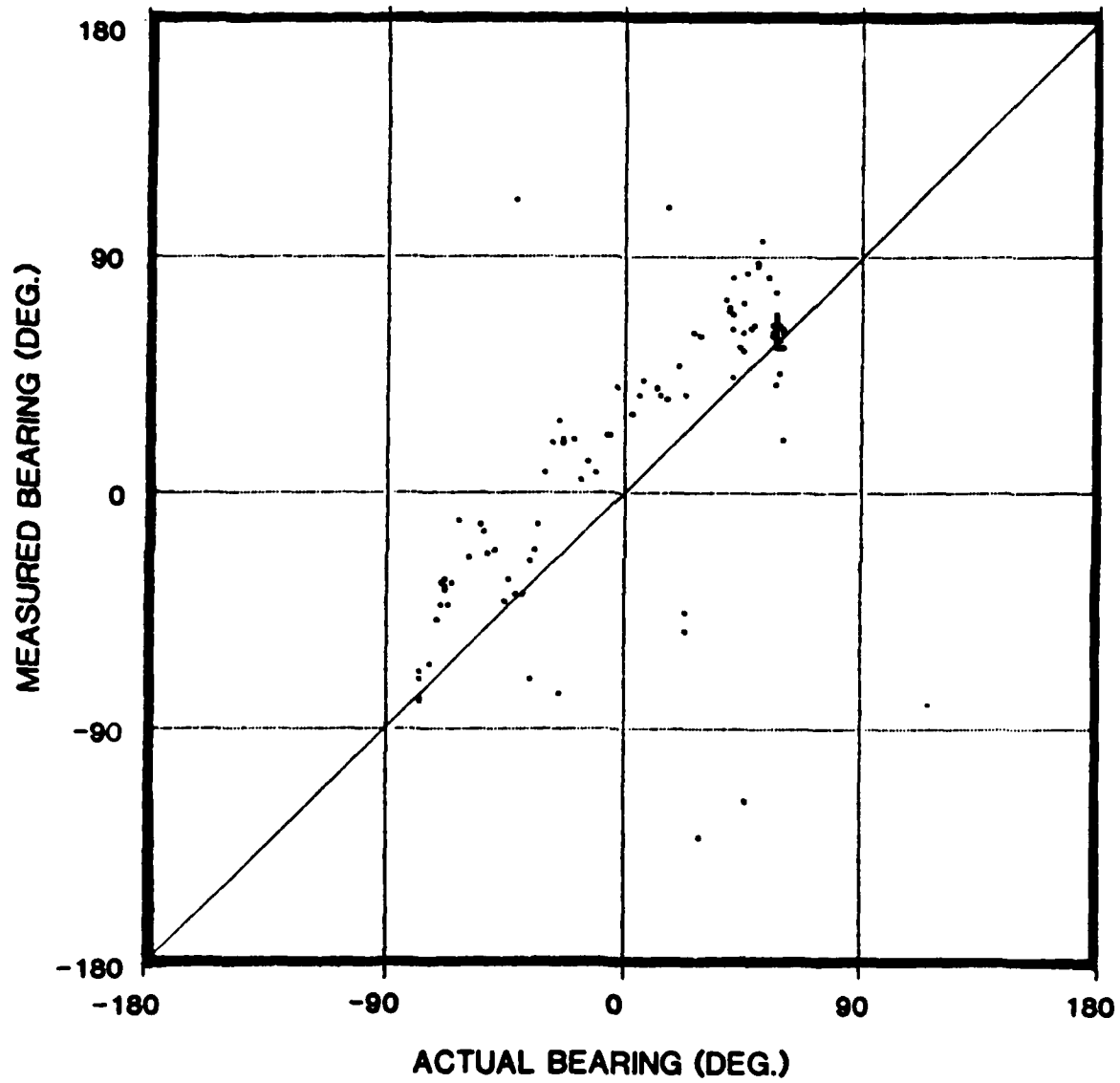

Fig. 4-7. Airborne AOA measurements using shaft-encoder sighting system.

100532

view. To characterize AOA performance, the hovering helicopter was rotated slowly through a full 360° several times to assess repeatability. During that portion of the rotation in which the transponder was in the forward quadrant, the sighting system was used to measure actual bearing directly. At other points in the rotation the sighting system was trained on one of several prominent objects on the airport (such as the control tower), which were previously surveyed to determine their bearing offsets relative to the fixed transponder. Thus, when combined with the appropriate offset during later data analysis, the sighted bearing provided an accurate indication of the true bearing of the transponder over a full 360° arc.

The results of the first of these measurements, conducted on two different days, are plotted in Figs. 4-8 and 4-9. The results from separate tests on different days agreed closely in mean error (40° vs 35°) and in the standard deviation about this mean.

The AOA errors were not limited to the aft direction, in which the most obvious obstructions exist, but rather were found in all directions including the forward quadrant. In fact, although signal strength is less in the aft direction by a few dB (see. Fig. 3-4), Figs. 4-8 and 4-9 show that the aft AOA performance was not significantly worse relative to performance in other directions.

4.2.6 Hovering Measurements After Removal of Bias

A comparison of the hovering data of 4.2.5 (Figs. 4-8 and 4-9) with the data obtained previously from airborne measurements at higher altitudes, (given in Fig. 4-7 for the forward quadrant and in Fig. 4-5 for the left and right quadrants) indicated that the hovering data, which could be obtained quickly and conveniently for a full 360 degrees of rotation with the shaft-encoder sighting device, was a valid representation of the AOA performance in airborne encounters.

Consequently, it was decided to use the data of 4.2.5 to establish a new bias offset for the TEU in the helicopter in preparation for a series of operational flight tests along helicopter routes in Boston and New York City. Specifically, the AOA transfer functions plotted in Figs. 4-8 and 4-9 exhibit a combined mean error of 38 degrees. This was combined with the software offset in use previously to yield a new offset.

After the new offset was entered into the TEU, an additional hovering test was flown to verify that the offset was correct. The results are plotted in Fig. 4-10. (The plot extends beyond 360 deg. in order to provide a continuous display of the transfer function in the aft direction.)

As shown in the figure, there remained a residual bias error of 13 degrees. Although this was considerably larger than expected, no consistent bias offset errors were observed by pilots and cockpit observers. Therefore no further corrections to the bias offset were applied during the course of the operational flight tests. (Subsequently, it was observed that a

TEU-2-2

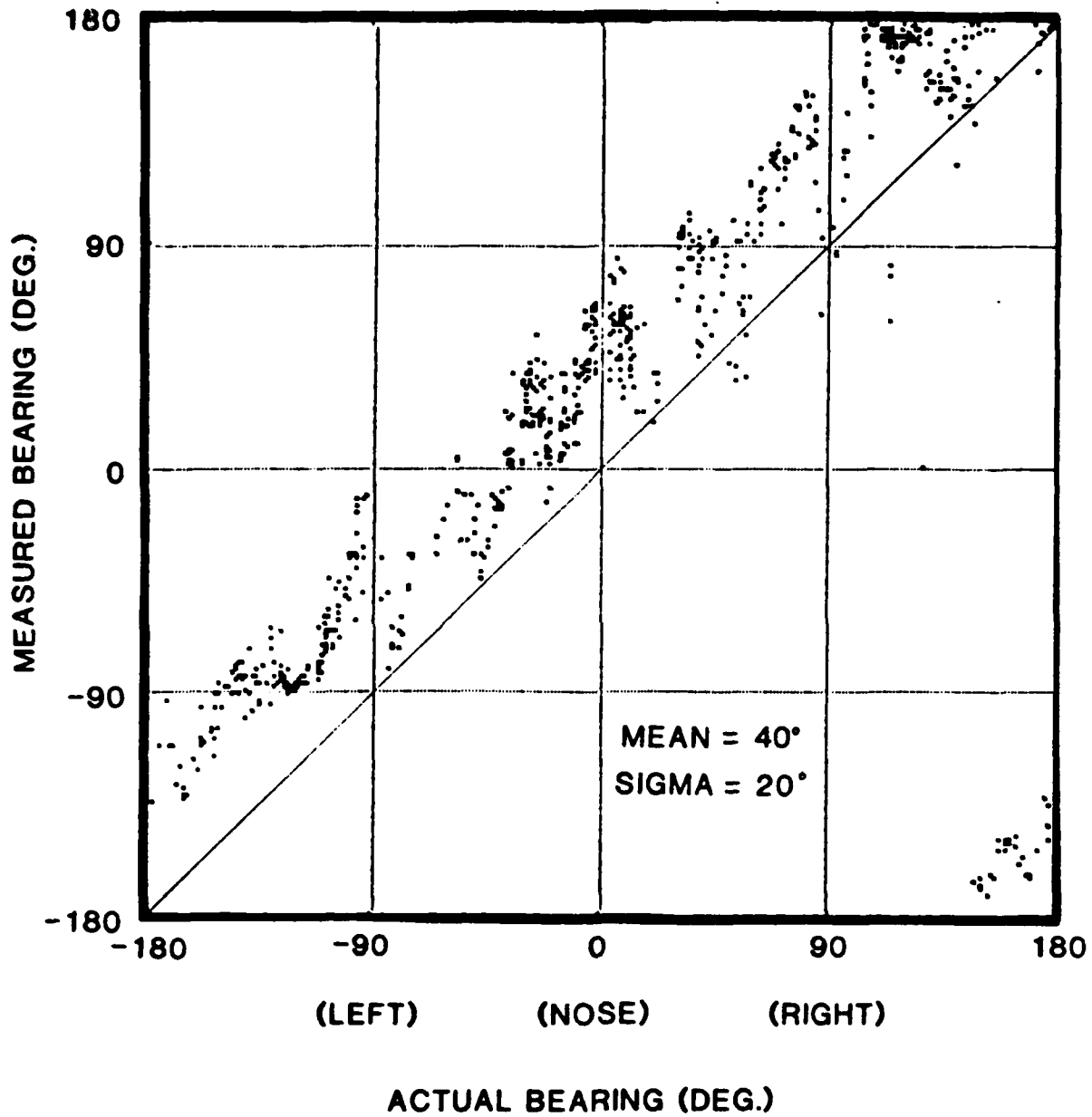

Fig. 4-8. AOA performance hovering just above the ground (30 Nov. 84).

100432

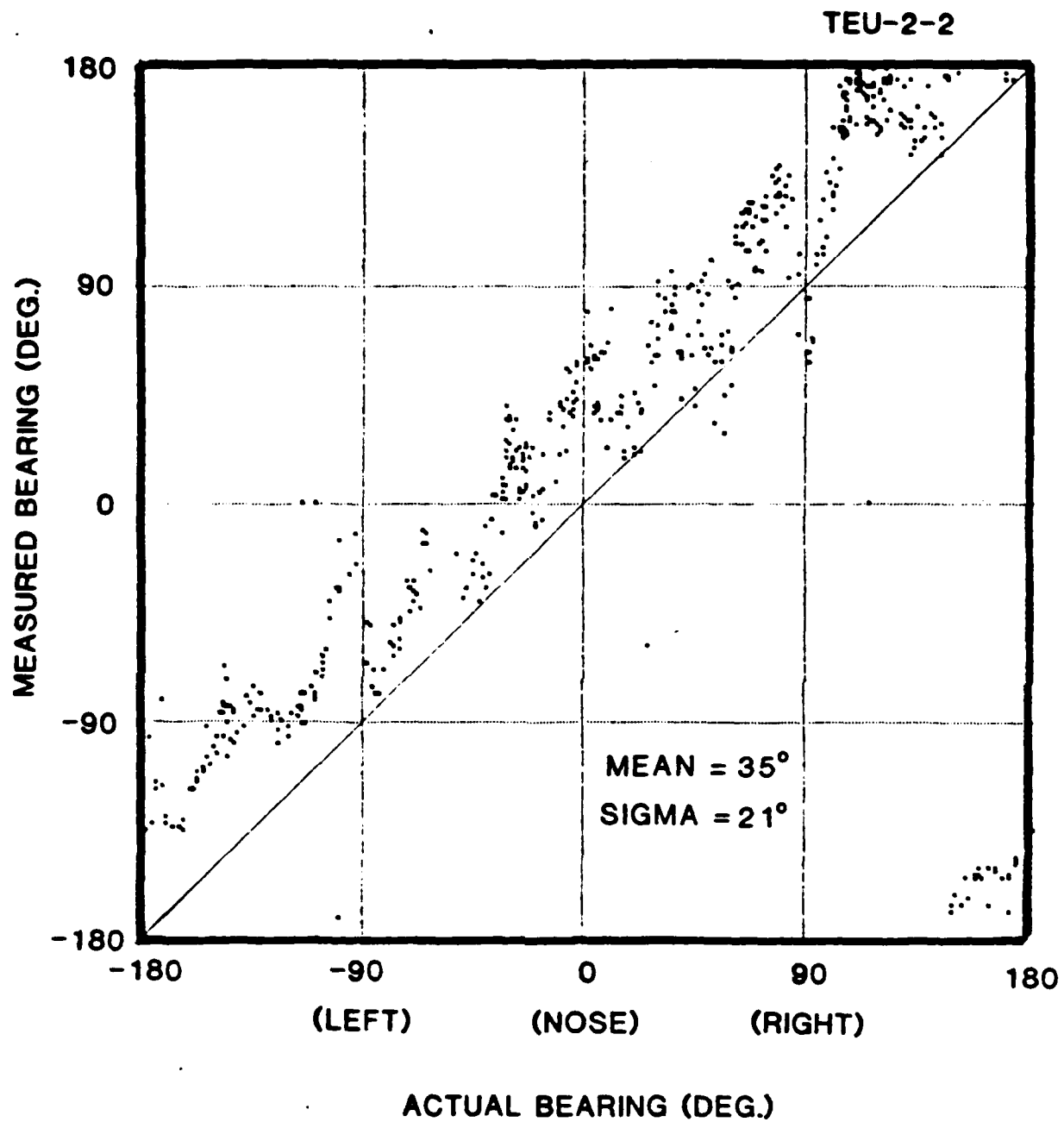

Fig. 4-9. AOA performance hovering just above the ground (12 Dec. 84).

NOTES: Measured 12 Feb. 85
top-forward antenna,
TEU-2-2. Software offset = 249°

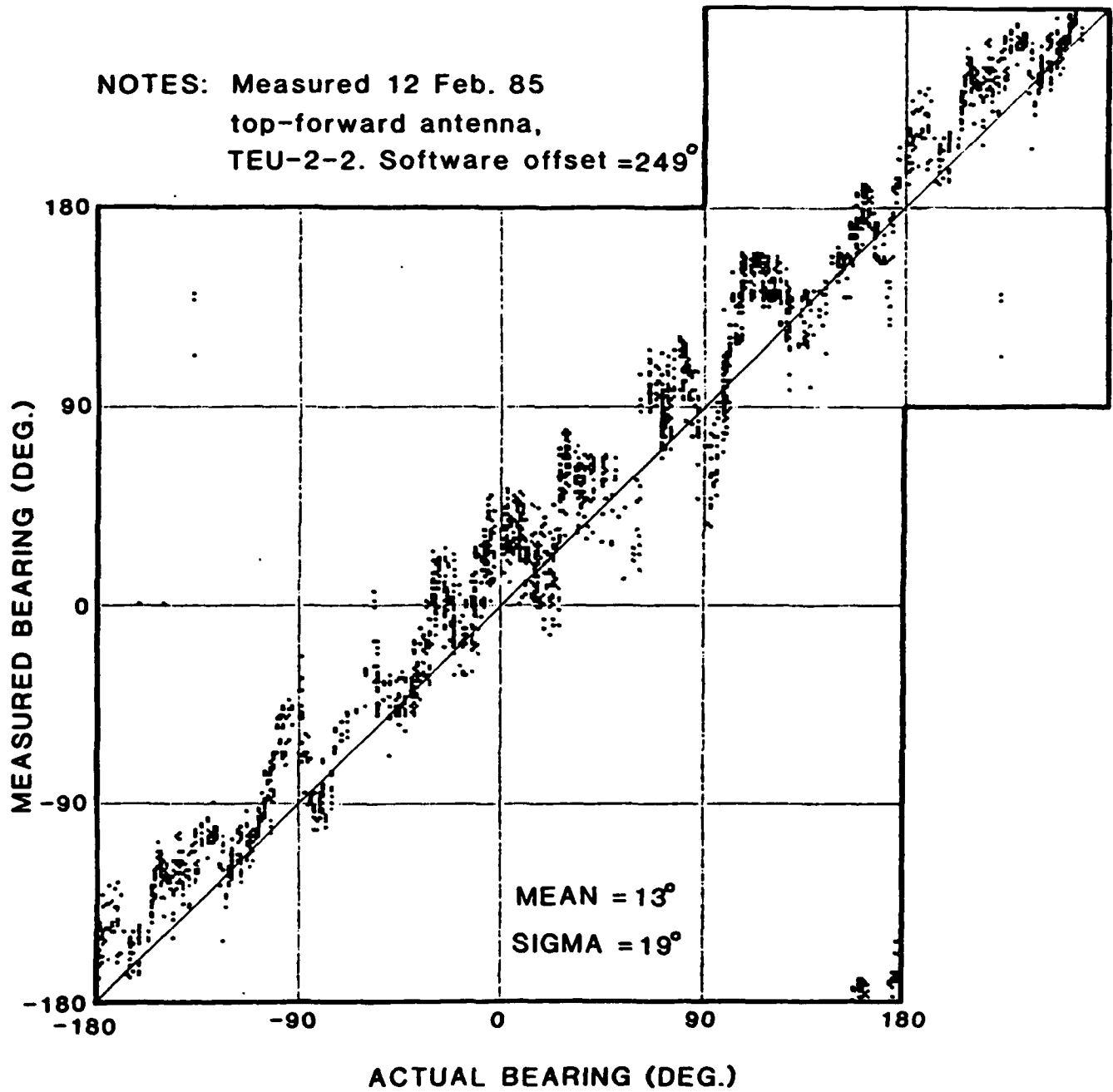

Fig. 4-10. AOA transfer function, hovering just above the ground,
new bias offset value.

100678

bias drift of this magnitude occurred regularly in the AOA circuitry of the TEU after initial turn-on and could be overcome by allowing a 40-minute warmup period before each flight.)

4.2.7 Aft Performance, Hovering Above Ground

It is evident from Fig. 4-10 that AOA accuracy in the aft direction is comparable to the accuracy elsewhere despite the obvious metallic obstructions to radio waves arriving from the aft direction as illustrated by Fig. 4-11.

To further investigate this phenomenon, a 360-deg. calibration measurement was performed for the antenna mounted aft of the main rotor and the engine exhaust port. This antenna was included in the original installation to allow for the possibility of complementing the top forward antenna if it performed poorly in the aft direction. Conceivably, the forward antenna would be used to cover targets forward and to the sides, while the aft antenna would cover targets to the rear. Note that the aft antenna location is very close to a relatively large exhaust port. As a result of this, the forward-looking performance of this antenna was predicted to be quite poor.

Figure 4-12 gives the measured AOA transfer function of this top-aft antenna, obtained using the technique of hovering near the ground. The AOA performance is not dramatically better in the aft direction than the performance of the forward antenna. Two regions of significant errors are seen around $\pm 45^\circ$. These are probably attributable to the edges of the exhaust port. Otherwise the AOA performance is not degraded excessively in any direction, including the forward direction.

Comparison of Figs. 4-10 and 4-12 shows that the aft antenna provides only slightly better accuracy in the aft quadrant. From this result it may be concluded that a single direction-finding antenna array in the top forward location on the helicopter provides approximately the same level of bearing estimation accuracy in all directions that would be obtained by multiple arrays. Multiple antennas would clearly not improve the accuracy of the bearing estimate in the aft direction sufficiently to warrant the additional cost and weight.

4.2.8 Hovering at an Altitude of 500 ft

The final step in the sequence of AOA calibration tests for the helicopter was to verify that there was no difference between the measurements obtained while hovering near the ground and measurements made while hovering at a more typical operational altitude. In general, it is most useful to make such calibration flights for target elevation angles of zero degrees. This is most practical when hovering just above the ground.

In order to assure that future measurements could be restricted to hovering above the ground, a calibration run was conducted while hovering at an altitude of 500 ft.

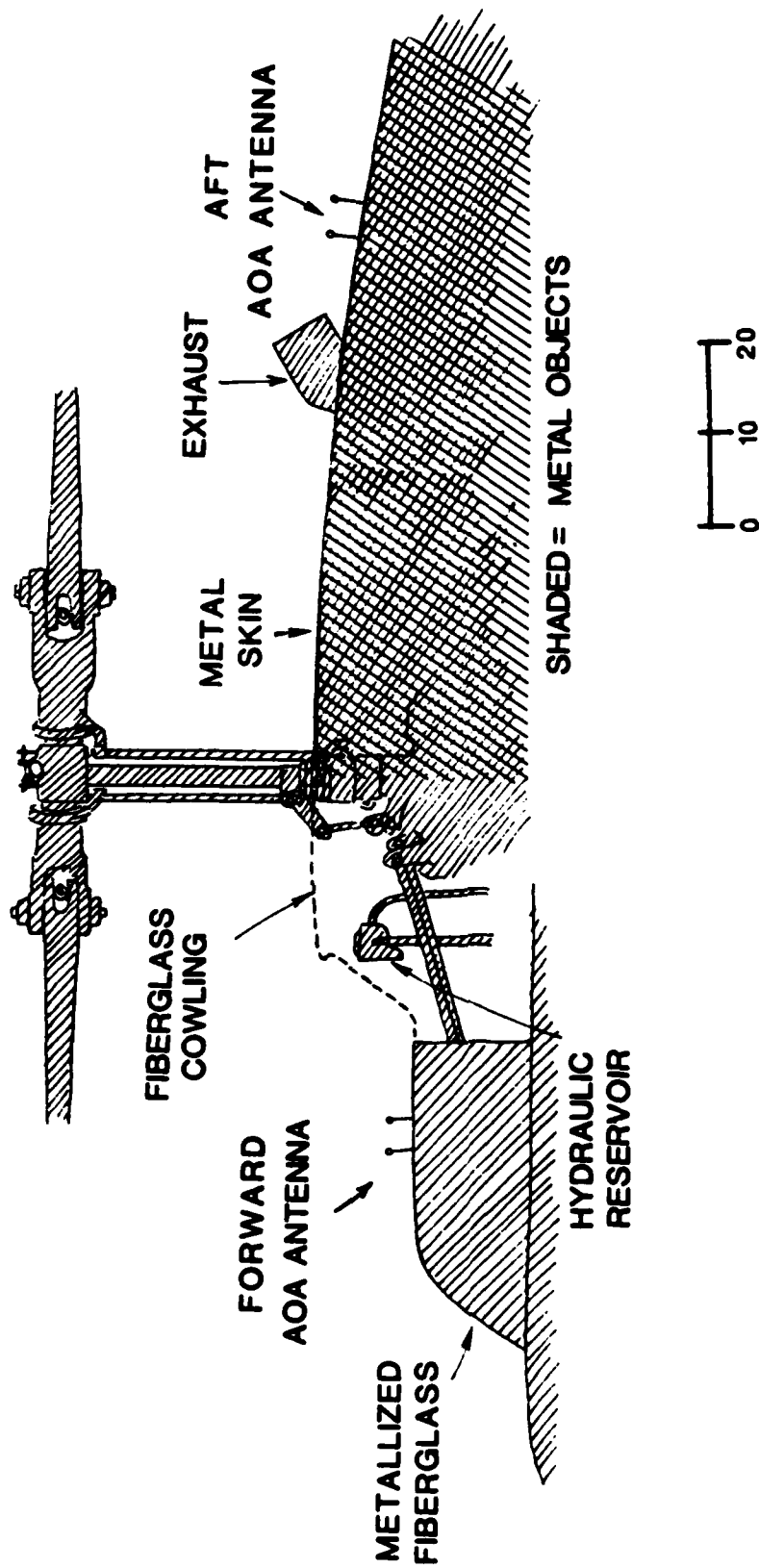

Fig. 4-11. Metal objects in the vicinity of the helicopter antenna.

100541

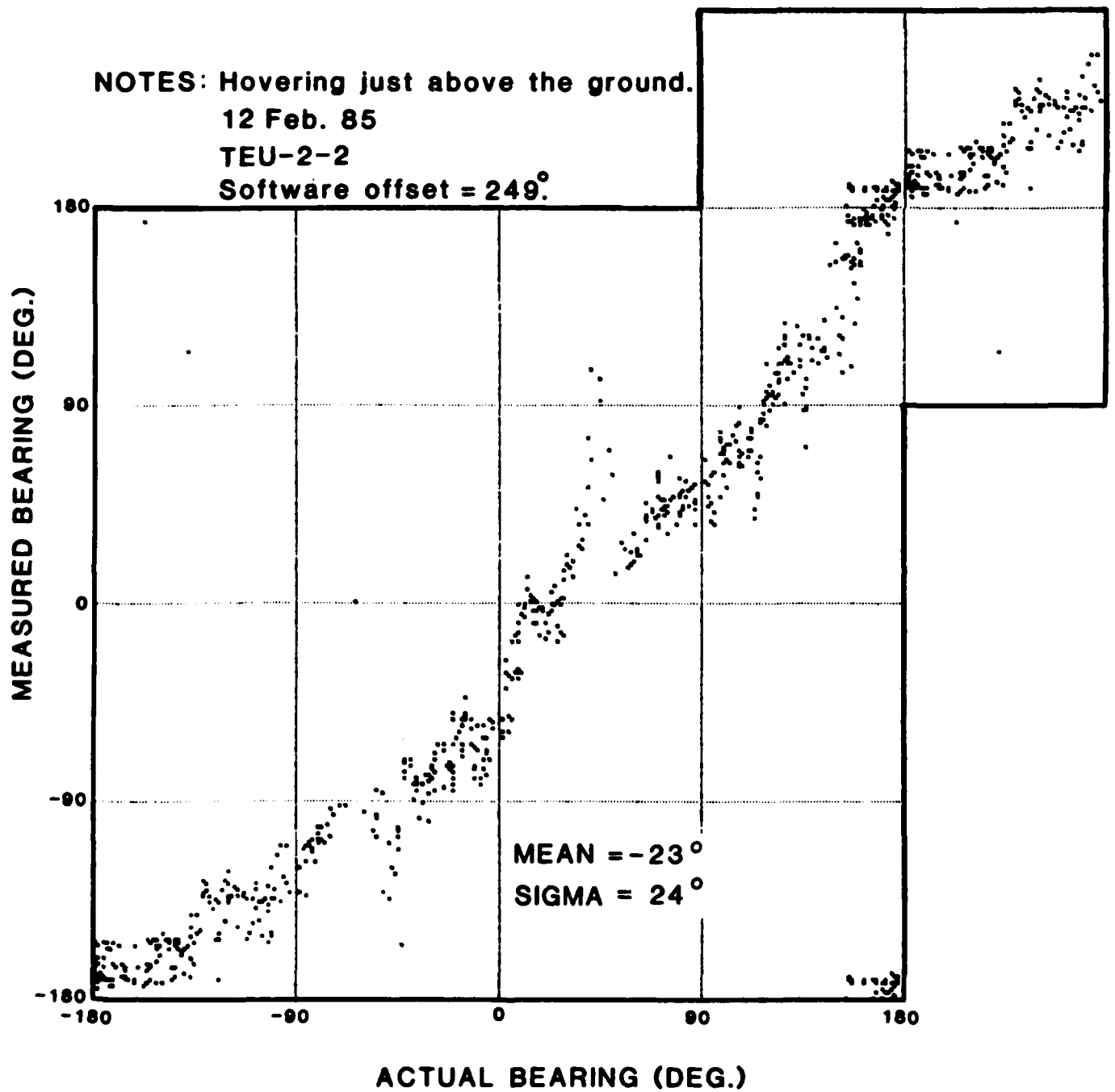

Fig. 4-12. AOA transfer function, top-aft helicopter antenna.

100675

The transponder target used in this measurement was mounted on a tower on a nearby hill (MODSEF), approximately coaltitude with the airborne helicopter. While the helicopter was slowly rotated through 360°, values of actual bearing were obtained using the shaft encoder sighting system. Results are given in Fig. 4-13.

These results are consistent with the data obtained previously while hovering near the ground. The mean and rms values computed* from the data in Fig. 4-13 are 0.2° and 21° respectively.

From these results it may be concluded that the AOA performance of the helicopter TCAS installation can be successfully measured while hovering just above the ground. The method based on hovering near the ground is an accurate way of predicting AOA performance when flying at operational altitudes.

4.2.9 Stability of the AOA System

The AOA system is made of of several distinct groups of components, each of which contributes to the net stability of the whole. The RF components of the AOA system were found to have a stable and repeatable phase bias each time they were measured on an antenna test range. However, the AOA receivers and digital processor systems in the TEU were found to exhibit a measurable phase drift, apparently caused by temperature changes, each time the TEU was activated from a cold start.

Fig. 4-14 is a plot of the observed AOA drift of the TEU as a function of time after activation after remaining at room temperature (approximately 70 deg. F) overnight. The input to the dual receivers of the TEU was obtained from a single reply generator fed through a power splitter and a pair of matched cables, simulating the receipt of a reply from a fixed bearing angle. The indicated bearing varied smoothly and continuously, resulting in a total drift of about 14 deg. over a period of about 40 minutes.

Although it was not determined exactly which component(s) in the TEU were responsible for this drift, it is expected that such a warm-up drift could be prevented by proper component selection and matching during manufacture of commercial TCAS equipment.

In addition to the short-term stability of the AOA technique there remained the question as to the long-term stability of this phase comparison technique in an airborne environment.

To investigate the longer-term stability of the AOA system, a series of five calibration flights were undertaken over a period of six weeks. The development of a simple and practical hovering technique for in-flight calibration of the AOA transfer function made it possible to investigate with some accuracy the stability of the AOA subsystem while airborne.

*The data points in Fig. 4-18 include a few outliers, which may be due to interference effects. Before this computation, points beyond ±90° were eliminated.

NOTES: Measured 15 Feb. 85,
top-forward antenna,
TEU-2-2, software offset = 249°

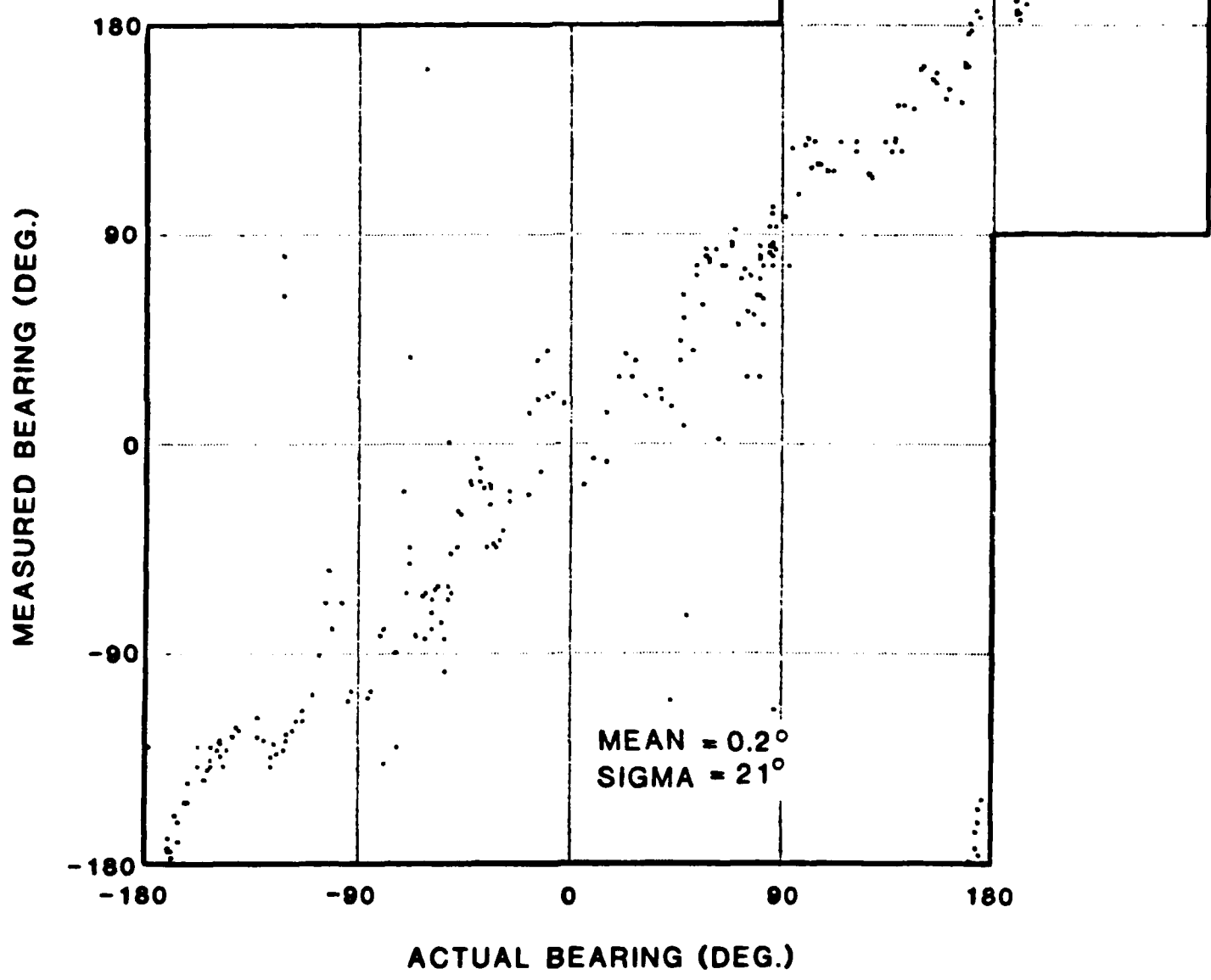

Fig. 4-13. AOA transfer function, helicopter at 500 ft. altitude.

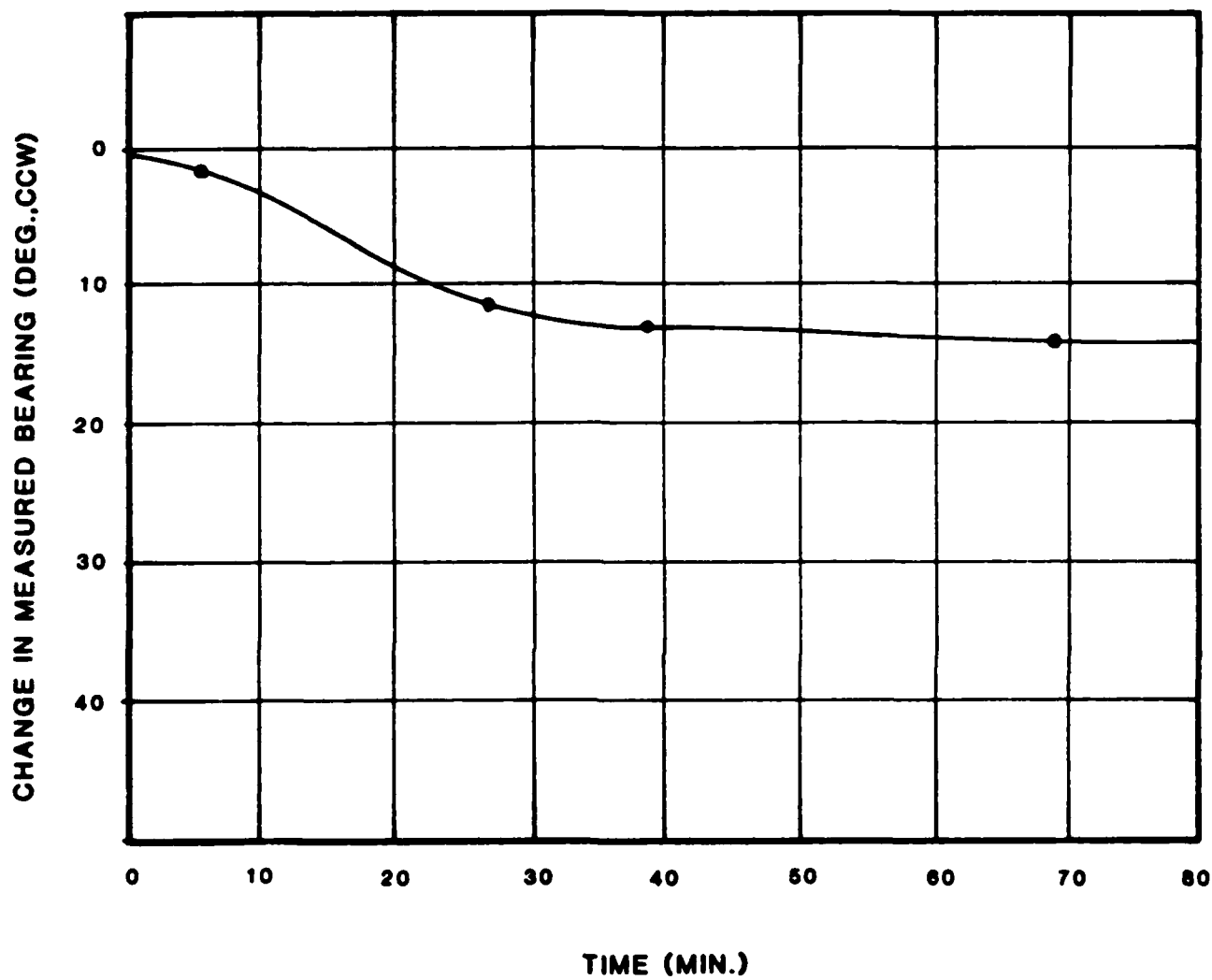

Fig. 4-14. AOA warm-up behavior.

During this period the helicopter was used principally for conducting the subject pilot flight tests reported in Ref. 8. The TEU equipment was neither removed from the aircraft nor recalibrated at any time during this period. Each calibration flight consisted of several 360 deg. rotations while hovering just above the ground prior to the start of a subject pilot test. The AOA transfer function was obtained using the shaft-encoder sighting device. The equipment was allowed to warm up for at least 40 minutes on the ground before each calibration test.

The flight-to-flight variation (relative to its value on the first flight) of the AOA transfer function offset bias over the forward quadrant (where the accuracy of the measurement is greatest) is plotted in Fig. 4-15. It is seen that there was very little variation in these measurements over the six-week period of the tests, and, in fact, the final measured value of AOA offset bias was identical to the initial value. This result is also consistent with the qualitative observations of all those who flew the system during this period.

Although this was not an exhaustive evaluation of stability and it occurred over a relatively short period of time in a season without pronounced temperature changes, it provided some confidence that a simple phase comparison technique can provide consistent measurements over time in a pseudo-operational environment.

4.3 AOA Accuracy in Planned Airborne Encounters

4.3.1 Introduction

The final phase of the helicopter AOA performance flight test evaluation consisted of a short series of planned encounters with a fixed-wing aircraft. These tests served as an evaluation of the overall performance of the AOA system including the bearing tracker. Specifically, they permitted an assessment of the correctness of the TCAS II tracker gains and correlation windows.

4.3.2 Encounter Measurements with Forward Antenna

Figure 4-16 shows, in the form of polar plots, the traffic advisories generated during two planned encounters. These were crossing encounters with a Beechcraft Bonanza equipped with a standard ATCRBS transponder. Air-to-air surveillance was carried out in Mode C. The TCAS traffic advisories plotted were obtained by tracking and smoothing the individual target reports according to the standard TCAS II smoothing formulas. Along with the TCAS traffic advisories, the figure shows the true location of the target aircraft, as determined by the use of the sighting device and shaft encoder described in Section 4.2.4.

In both of the encounters, AOA inaccuracies are evident. Yet the AOA performance is seen to be serviceable. The instantaneous error is consistently less than the size of the triangle target symbol used on the display. The rms bearing error computed from the data in Fig. 4-16, is 9° in encounter 1 and 6° in encounter 2.

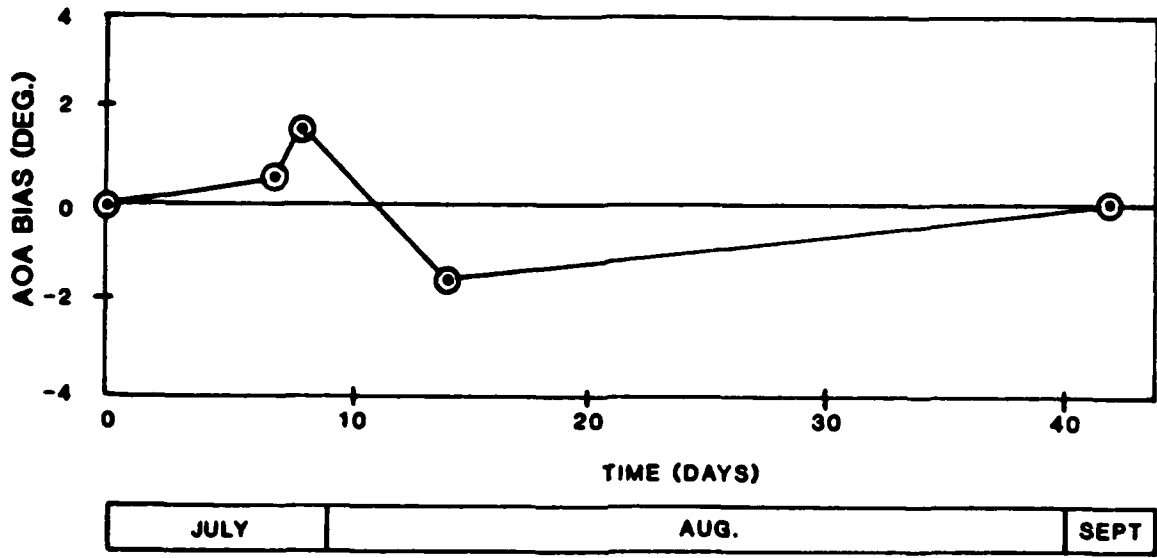
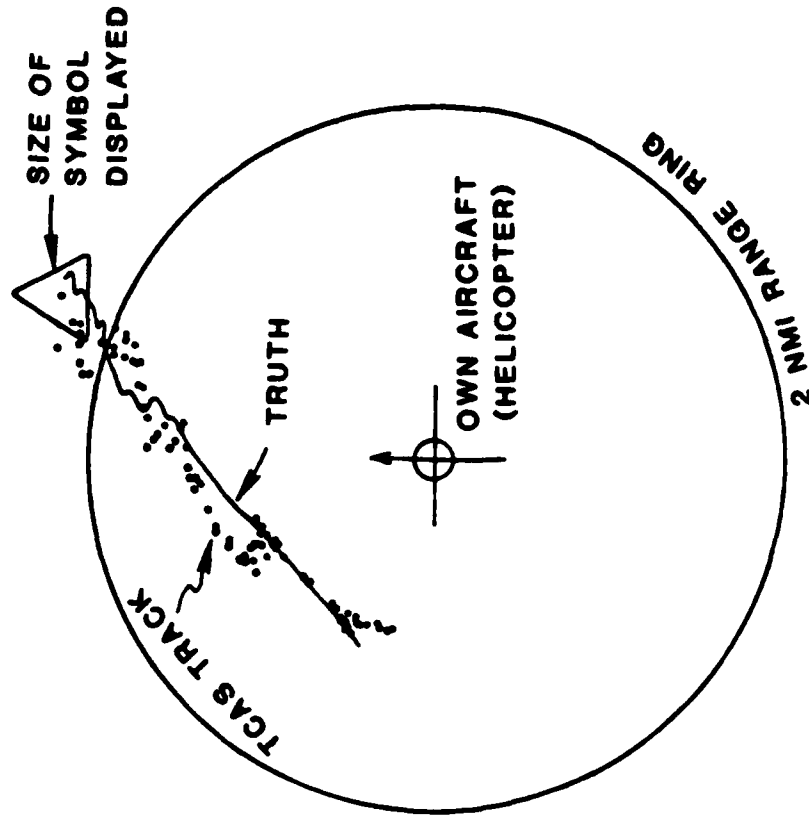
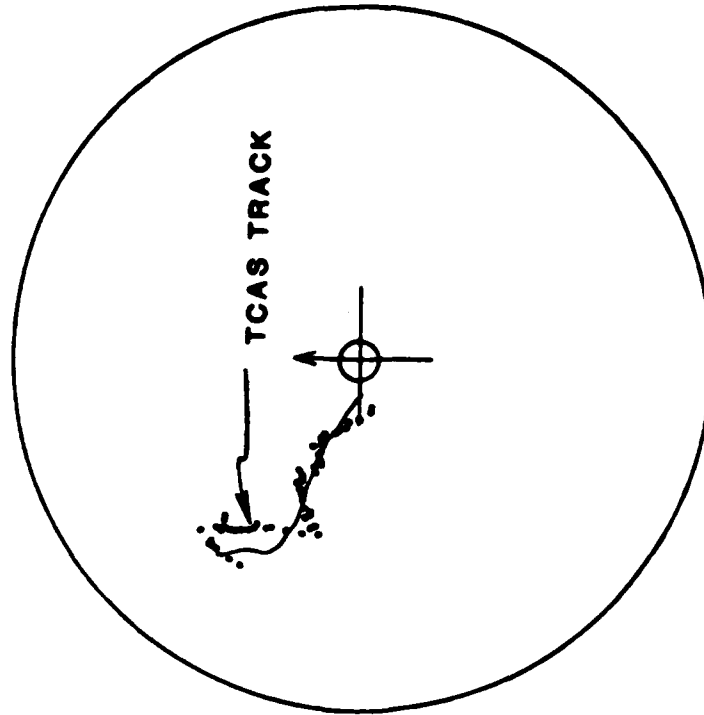

Fig. 4-15. Top-mounted helicopter antenna stability.

ENCOUNTER 1



ENCOUNTER 2



NOTE: Top-forward AOA antenna.

Fig. 4-16. Two encounters with crossing aircraft.

100679

4.3.3 Encounter Measurements with Aft Antenna

The performance of the aft AOA antenna is shown in the polar plots in Fig. 4-17. This figure came from a single crossing encounter (Encounter No. 1 from Fig. 16) tracked simultaneously by TCAS in two different ways: surveillance via the top-forward antenna in one plot and surveillance via the top-aft antenna in the other.

In these polar plots there are no range errors between the true track and the estimated track. The deviations in the track plots are caused solely by bearing errors. The forward antenna resulted in a peak bearing error of about 20 degrees, occurring at a true bearing of about 350 degrees. (That is, when the target was actually 10 degrees to the left of the nose of the helicopter, it appeared on the display at about 11 o'clock.) The peak error for the aft antenna occurred at roughly the same true bearing, and was somewhat larger, resulting in a displayed bearing of about 320 degrees when the true bearing was 350 degrees.

The fact that the peak errors occurred simultaneously on fore and aft antennas appears to be coincidental. There is no physical reason for similarity in the error behavior of the two antennas. They viewed the target from different vantage points and experienced distinctly different local scattering environments. Analysis of the error as a function of true bearing for the remainder of the encounter indicated that there was no strong correlation between the behavior of the fore and aft antennas.

It appears from this result that, although the forward antenna resulted in greater accuracy for the encounter target in the forward direction, either antenna would have provided useful bearing estimates in this encounter. It may be concluded from this experiment that an antenna location even as apparently unfavorable as that of the aft antenna, which was obstructed over nearly the entire forward quadrant by the exhaust port, would still support a useful traffic advisory capability for the helicopter pilot.

4.3.4 Bearing Tracker Performance in Helicopter Turns

Bearing track data from both planned and unplanned encounters with other aircraft was analyzed to determine the effect of the high turning rate of the helicopter relative to fixed-wing aircraft.

An experienced helicopter pilot can execute pedal turns at rates of 20 to 30 deg. per second compared to a standard-rate turn of about 3 deg. per second for fixed-wing aircraft. If the helicopter turns at a time when a target is itself passing the helicopter at close range, net apparent bearing rates as high as 45 degrees per second can result.

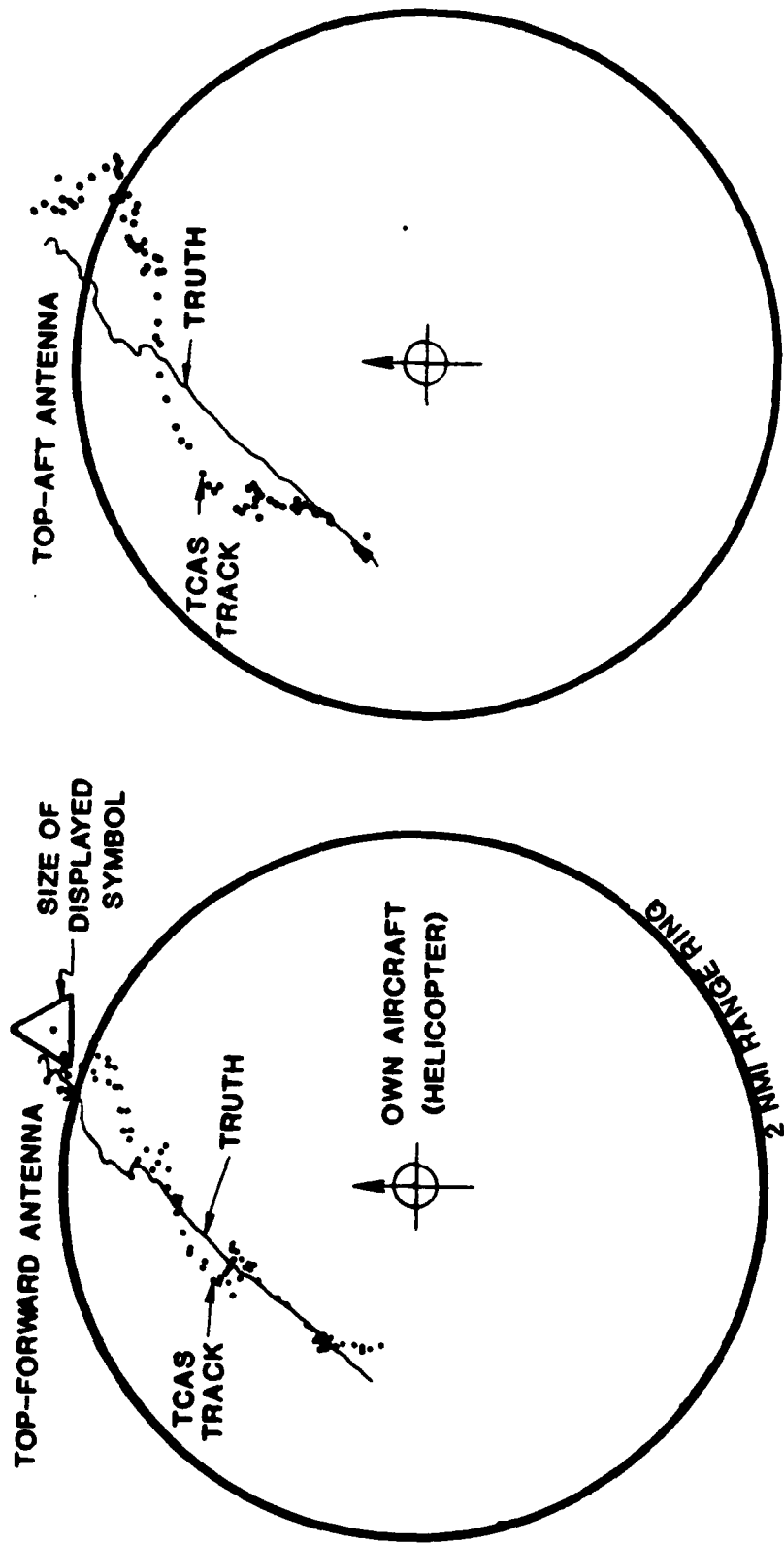

Fig. 4-17. Comparison of forward antenna and aft antenna bearing estimation performance for a target in the forward direction.

101000

It was found that the bearing tracker design originally recommended for TCAS II in Ref. 4 sometimes resulted in significant bearing tracker lags during fast helicopter turns. The original tracker design employed a relatively wide bearing correlation window (its initial width of 45 degrees was doubled each time the tracker was forced to coast for lack of a correlating bearing update). Even with this apparently generous correlation window, it was found that the tracker was occasionally unable to correlate on valid bearing updates during fast helicopter turns.

To eliminate this problem, the TEU bearing tracker was modified to eliminate the bearing correlation window altogether and allow a track to be updated with any report that correlates in range and altitude. The bearing tracker gains were not changed from the values recommended in Ref. 4.

The windowless tracker was tested in the series of operational flight tests reported in Ref. 8 and found to be somewhat more responsive to fast turns without suffering any noticeable degradation in accuracy. Subsequently, the recommended design of Ref. 4 was changed to eliminate the bearing correlation window for all TCAS II designs. (See RTCA Paper No. 469-85/EC-956, "Change No. 2 to RTCA/DO-185", 20 September 1985).

4.4 Possible Use of Absorbing Material to Improve AOA Accuracy

4.4.1 The Need for Absorbing Material

It is evident from all of the bearing calibration transfer functions shown above that there are significant errors that show up as ripples in these transfer functions independently of the superimposed "noise" caused by the movement of the main rotor. This fact suggests that the mechanism causing these fixed ripples is electromagnetic scattering from the fixed elements of the main rotor drive mechanism such as the mast and transmission. As shown in the sketch of Fig. 4-11, a number of metallic objects were located within a few wavelengths of the top forward antenna on the Jet Ranger.

Experiments were conducted to determine if the performance of the forward antenna could be improved by placing a thin resonant radio absorbing material (Eccosorb SF-1, manufactured by Emerson and Cummings) between the antenna and these metallic objects. This material was installed over the fiberglass cowl just behind the forward AOA antenna. For proper operation, it was necessary to install the absorbing material on a metallic surface. Accordingly, a sheet metal cover was installed over the surface of the fiberglass and the absorbing material was bonded to the metal.

The technique was first investigated at an anechoic antenna test range using a simulation of the near-field helicopter scattering environment. It was then flight tested on the Jet Ranger.

4.4.2 Anechoic Chamber Measurements of Absorbing Material

The actual layer of absorbing material (with its metal backing) that was used on the helicopter was tested in the anechoic chamber with a simulation of the helicopter mast and control rods. The test setup is illustrated in Figs. 4-18 and 4-19. Three cylinders were mounted on a turntable and placed at a distance from the test antenna equal to the distance on the helicopter between the antenna and the rotor shafts. The cylinder sizes and spacings also matched those of the helicopter. Bearing transfer functions were obtained by rotating the entire apparatus around a vertical axis through the center of the array of four monopoles that made up the AOA antenna.

The antenna AOA transfer function was first measured without reflecting material. The results are shown in Fig. 4-18. The shaded band in this figure shows the variation in the bearing output as the shafts rotated. The rotating cylinders had a significant effect on the AOA performance as can be seen by comparing Fig. 4-18 with Fig. A-11 which shows the results of an anechoic chamber measurement of the AOA antenna in free space.

The rotating cylinders caused an envelope ripple to appear in the transfer function along with superimposed scatter. The ripple was sufficiently large that the AOA function lost its monotonicity. The resulting transfer function is similar to those measured on the actual helicopter and suggests that the rotor shafts are indeed responsible for much of the observed scattering.

The measurement was then repeated with the absorbing material in place in the same relative location as on the helicopter. The results are plotted in Fig. 4-19. The results indicate a significant improvement except for bearings around 180 degrees, where the performance was relatively good even without the absorber.

Antenna gain was also measured with and without the absorbing material. The results are plotted in Fig. 4-20. The addition of the absorbing material reduced the variation in the gain caused by the rotation of the cylinders when the AOA antenna was viewed from the forward direction. The average gain in the forward direction remained about the same when the absorber was added. As would be expected, the average gain was significantly reduced by the absorber when the AOA antenna was viewed from the aft direction.

4.4.3 Hovering Tests of Absorbing Material

The effect of the absorbing material was evaluated in flight using the technique of hovering just above the ground. The results are plotted in Fig. 4-21. Comparison with Figs. 4-8 and 4-9 shows that the scatter was reduced only slightly by the absorber. The standard deviation in the data was reduced from 20 or 21 deg. to 18 deg.

This inconsistency with the anechoic chamber results suggests that the AOA inaccuracy is caused by many more scattering components than those simulated in the anechoic tests. These might include the rotor blade itself, the hub at the top of the rotor mast, or the rectangular fluid reservoir shown in Fig. 4-11.

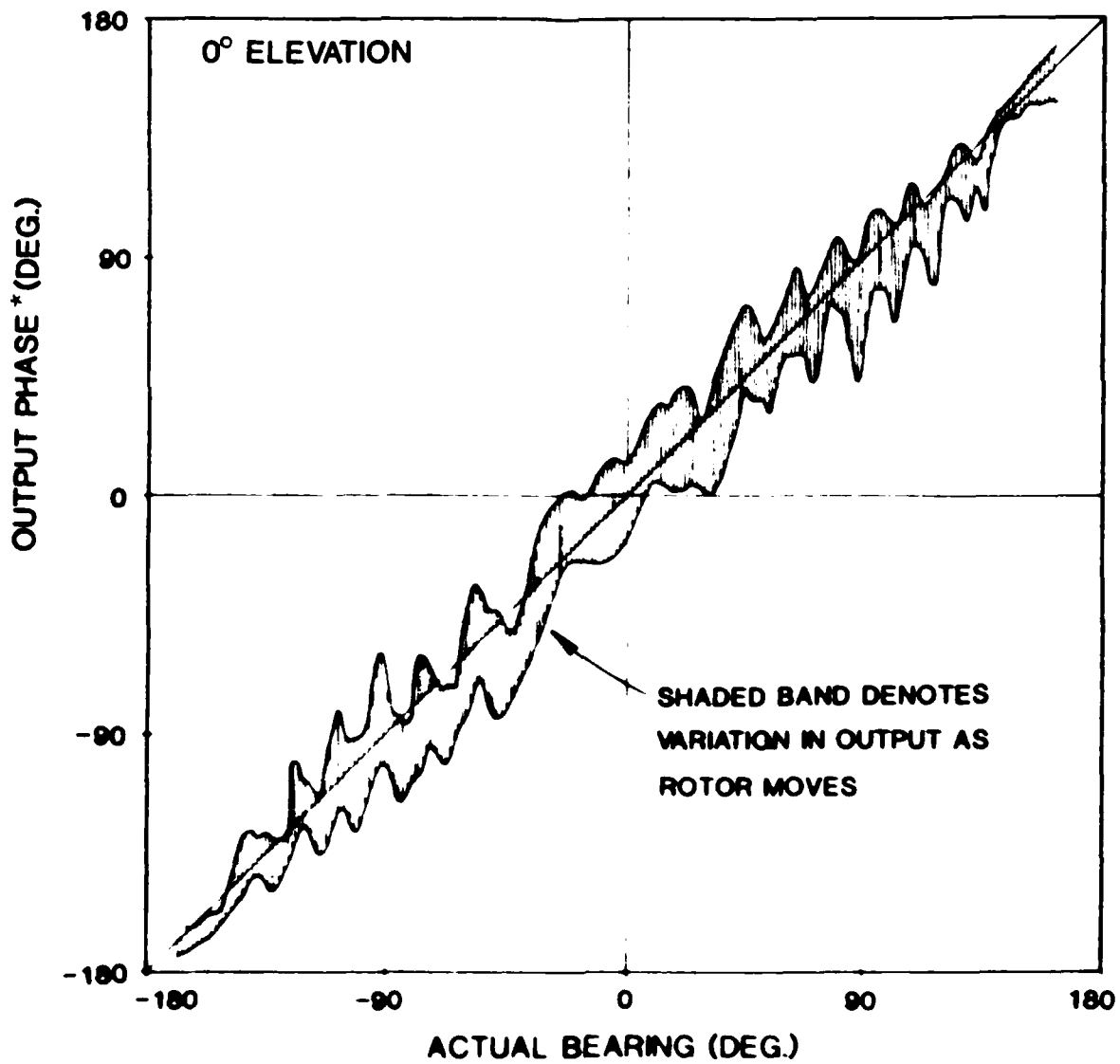
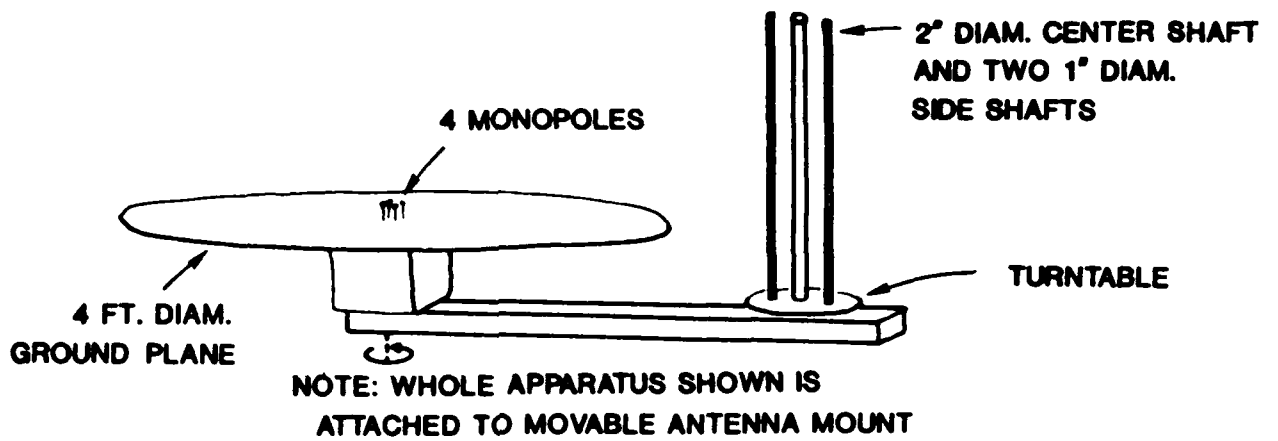

* Note: This measurement includes an unknown constant offset.

Fig. 4-18. Anechoic chamber results when a simulated helicopter shaft is present.

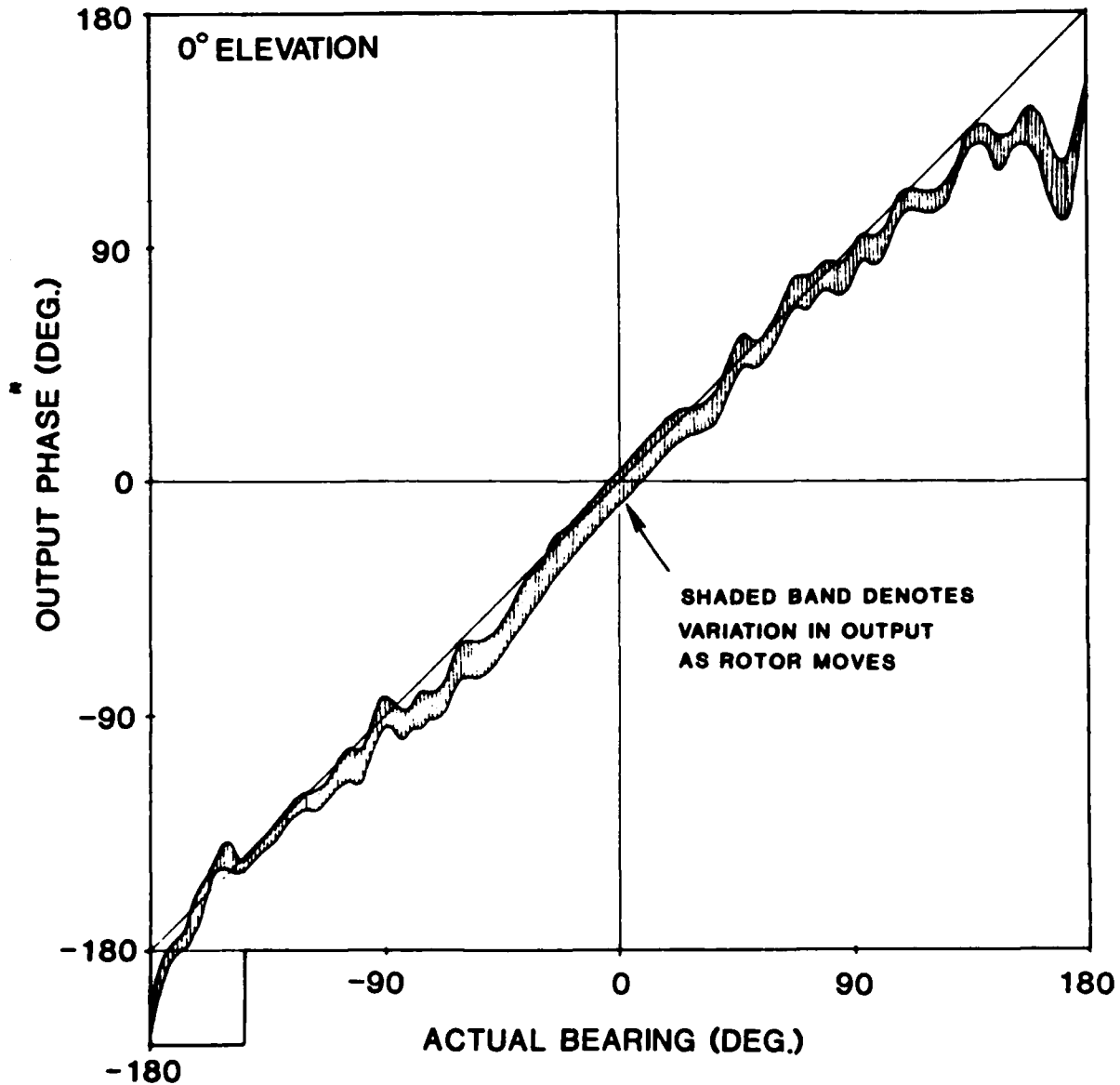
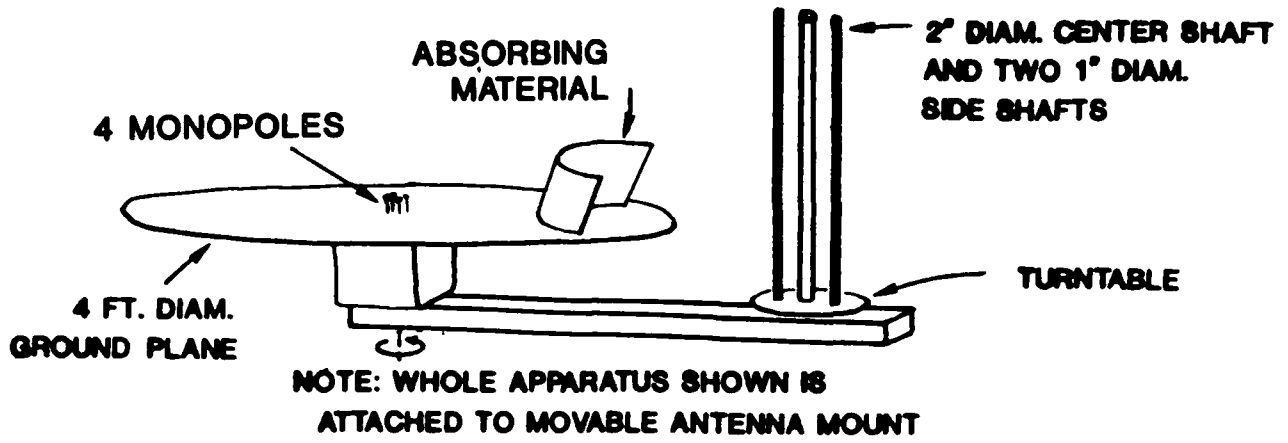

^m Note: This measurement includes an unknown constant offset, the same amount as in Fig. 10.

Fig. 4-19. Anechoic chamber results with absorbing material added.

100446

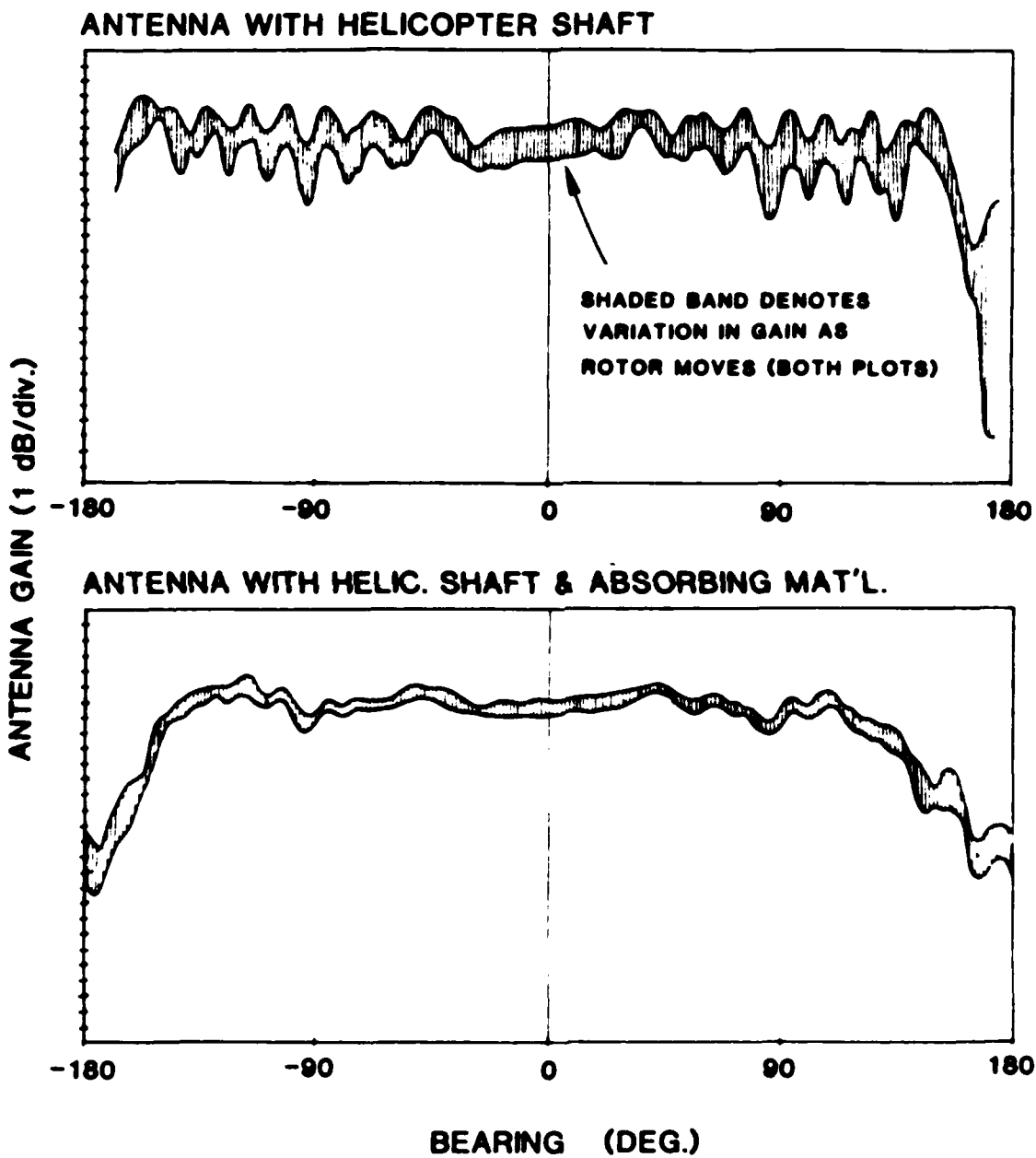

Fig. 4-20. Antenna gain measurements in anechoic chamber.

100445

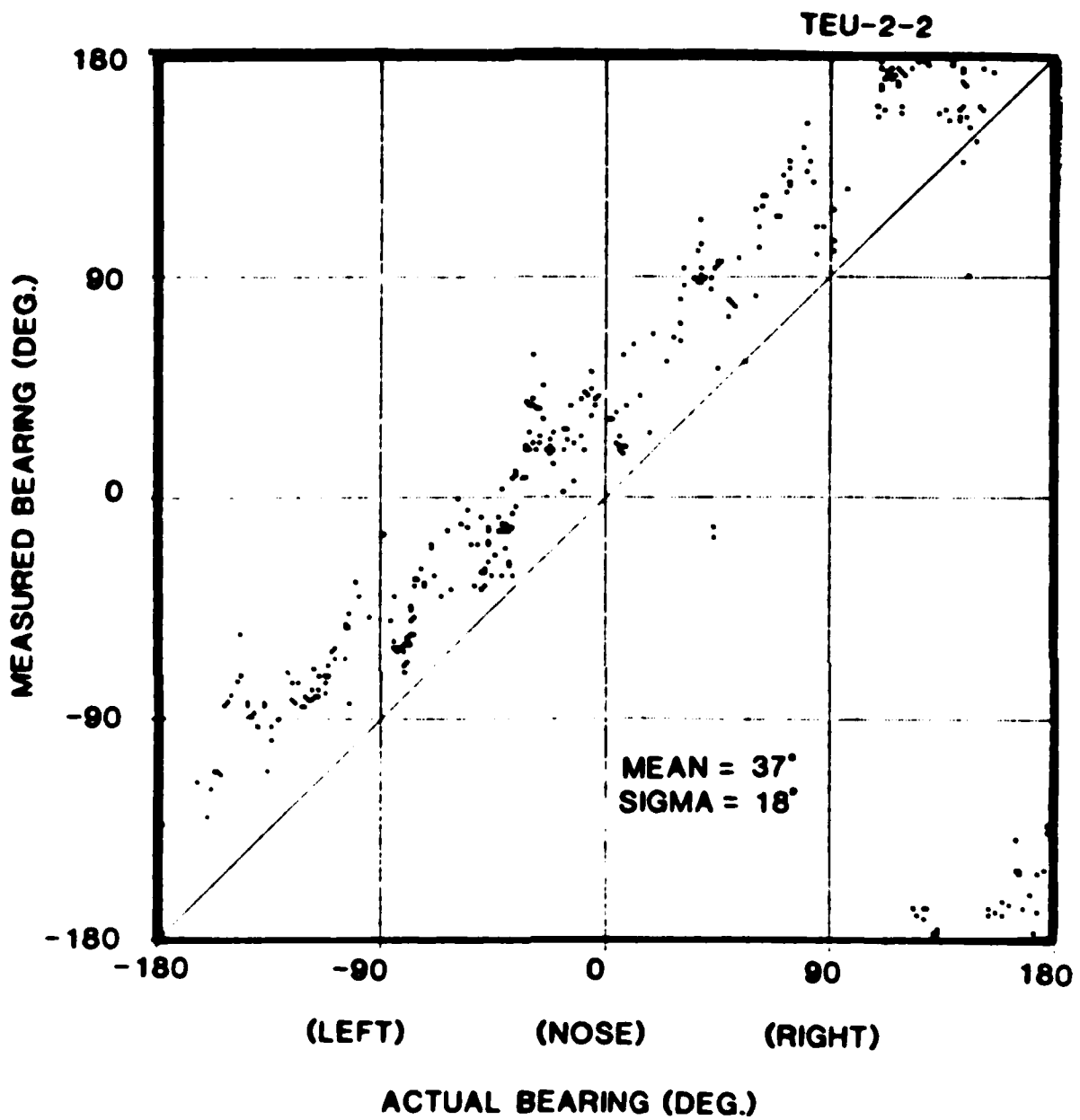

Fig. 4-21. AOA performance using absorbing material.

4.4.4 The Effectiveness of Absorbing Material

It was concluded from the flight test of the absorbing material that it was not sufficiently effective to warrant its use with operational TCAS equipment. The material is relatively costly (\$145 per square ft) and heavy (5 lb. per square ft). It is somewhat difficult to install because of its weight and because it requires a metallic backing. It is difficult to position the material such that it effectively shields the AOA antenna from all of the significant metallic scatterers on the helicopter airframe. And finally, it significantly reduces the gain of the antenna in the aft direction. Its use is not recommended.

5. CONCLUSIONS

5.1 General Conclusions

The omnidirectional TCAS surveillance design as now specified in RTCA DO-185 (Ref. 4) performs well enough to support a very useful traffic advisory service in the Bell Long Ranger helicopter. It would also be expected to perform well on other similar helicopter airframes.

5.2 Specific Link and Track Reliability Conclusions

The following specific conclusions are drawn with regard to the surveillance tracking performance of the experimental TCAS equipment as operated in a Long Ranger helicopter:

1) Ground-bounce multipath is slightly more serious at low altitudes than at high altitudes because grazing angles of less than 20 degrees are encountered a higher percentage of the time. However, multipath will not significantly degrade helicopter TCAS performance provided the TCAS employs a top-mounted antenna, whisper-shout, and dynamic thresholding.

2) It is not necessary or desirable to synchronize TCAS interrogations with helicopter rotor position. The tests showed that certain target-rotor position combinations consistently experience low two-way link reliability. Therefore, for certain target bearings, the rotor angular position and the time of TCAS interrogation must be independent. The experimental TCAS surveillance procedure employs multiple interrogations per track update period and allows the track to be coasted through several update periods (for both ATCRBS and Mode S targets). TCAS is thus capable of reliable tracking even when the round reliability drops below 50% provided the miss probability is independent from one interrogation to the next.

3) On the Long Ranger, link power margins adequate for providing reliable traffic advisories out to visual acquisition ranges of four miles or more can be obtained in all directions with a single top-mounted antenna installation despite blockage and reflections from the main rotor, the revolving rotor mast/control-rod assembly, and the main rotor transmission housing. Adequate link margins are also likely to be achieved on other similar rotorcraft airframes. When a single top-mounted antenna is employed in the forward direction, deep fades occur for targets behind and below the aircraft. These fades do not seem to be of sufficient operational concern to warrant changes to the experimental TCAS design.

4) Satisfactory tracking performance may be expected under most operational conditions. This conclusion is based upon the analysis of track data from many flights including those obtained under the dense traffic conditions observed in the New York City area. The overall reliability, or percentage of tracks for which the target was in track, during these operational flights was 87 percent.

5) A full whisper-shout sequence with an adequate number of low-power interrogations is needed to handle the larger numbers of short-range targets encountered in typical helicopter airspace. The standard TCAS II whisper-shout sequence is well suited for the rotorcraft environment.

5.3 Bearing Estimation Performance

The following specific conclusions are drawn with regard to the bearing estimation performance of TCAS as operated in a Long Ranger helicopter:

1) A simple direction-finding system was investigated on the Long Ranger, consisting of an array of four monopole antennas, an associated passive beam-forming network, a pair of phase-matched cables, and a pair of phase-comparison receivers. This system was found to provide a bearing estimation accuracy for ATCRBS-equipped intruders of approximately 20 degrees one-sigma. Although this is approximately twice the error measured for the same system on small fixed-wing aircraft, it is adequate to support a useful traffic advisory capability.

2) A single direction-finding antenna array on top of the helicopter is adequate. Multiple antennas would not significantly improve the accuracy of the bearing estimate in any direction. The exact location of the direction-finding antenna is not highly critical. It was found that, if necessary, the antenna could be located behind the main rotor and engine exhaust port and still provide serviceable traffic advisory capability in all directions.

3) Angular accuracy cannot be significantly improved by synchronizing interrogations with rotor position because the systematic variations in the AOA transfer function caused by reflections and scattering from the airframe and main rotor assembly are larger than the scatter from reply to reply that is caused by rotor motion.

4) Microwave absorbing material was investigated as a means of improving the performance of the direction-finding antenna. The material was not sufficiently effective to warrant its use with operational TCAS equipment.

REFERENCES

1. "TCAS I Functional Guidelines," RTCA/DO-184, Radio Technical Commission for Aeronautics, Washington, D.C., (May 1983).
2. Orlando, V.A., et al, "TCAS I Design Guidelines," Project Report ATC-114, Lincoln Laboratory, M.I.T., (24 September 1982), FAA-RD-82-12.
3. Orlando, V.A., Welch, J.D., "Traffic Alert and Collision Avoidance System (TCAS): A Functional Overview of Active TCAS I," Project Report ATC-118, Lincoln Laboratory, M.I.T., (8 April 1983), FAA-RD-DOT/FAA/PM-83-9.
4. "Minimum Operational Performance Standards for Traffic Alert and Collision Avoidance System (TCAS) Airborne Equipment," RTCA/DO-185, Radio Technical Commission for Aeronautics, Washington, D.C., (September 1983).
5. Welch, J.D., Orlando, V.A., "Traffic Alert and Collision Avoidance System (TCAS): A Functional Overview of Active TCAS II," Project Report ATC-119, Lincoln Laboratory, M.I.T., (8 April 1983), FAA-RD-DOT/FAA/PM-83-10.
6. Harman, W.H., Kennedy, R.S., "TCAS II: Design and Validation of the High-Traffic-Density Surveillance Subsystem," Project Report ATC-126, Lincoln Laboratory, M.I.T., (12 February 1985), DOT/FAA/PM-84/5.
7. Sinsky, A.I., Reed, J.E., and Fee, J., "Enhanced TCAS II Tracking Accuracy" AIAA/IEEE 6th Digital Avionics Systems Conference, 3 December 1984, AIAA 84-2738-CP.
8. Andrews, J.W., "Pilot Evaluation of TCAS in the Long Ranger Helicopter," Project Report ATC-136, Lincoln Laboratory, M.I.T., (3 June 1986) DOT/FAA/PM-85/30.
9. Paradis, A.R., "L-Band Air-to-Air Multipath Measurements," Project Report ATC-77, Lincoln Laboratory, M.I.T., (6 September 1977), FAA-RD-77-87.
10. Broste, N. et al, "Preliminary Evaluation of Active Beacon Collision Avoidance System Performance (Simulated): Protection and Alarms," MITRE Technical Report (April 1979), MTR-79W00135.
11. Billman, B., "Survey of Characteristics of Near Mid-Air Collisions Involving Helicopters," (May 1983), DOT/FAA/CT-83/40.
12. Spencer, D.A., et. al., "TCAS Experimental Unit (TEU) Hardware Description," Project Report ATC-133, Lincoln Laboratory, M.I.T., (6 June 1986), DOT/FAA/PM-85/2.

APPENDIX A

BEARING ACCURACY ANALYSIS

This appendix presents computed and measured transfer functions for the 4-element AOA antenna. Calculated results are given for the antenna by itself (neglecting mutual coupling effects and assuming a noiseless receiver) and for cases that include a reflector, intended to represent effects such as that of the rotor shaft of the Ranger helicopter. These calculations are compared with anechoic chamber measurements of the antenna to determine the effects of mutual coupling on the antenna accuracy.

A.1 Definitions and Basic Formulas

Figure A-1 shows the 4-element AOA antenna in the standard form used by Lincoln Laboratory and the standard notation (monopoles labeled A, B, C, D clockwise beginning at the front-left element as seen from outside the aircraft). It is shown in Fig. A-2 that the AOA performance is of the form

$$\text{phase}(\delta/\sigma) = \text{phase}(e^{jP}(A + jB - C - jD))$$

where P is an offset phase that depends on the insertion phases γ and δ of the π and $\pi/2$ hybrids. In the notation of the figure, phase delays are represented by negative values. For example, I is delayed with respect to j.

This section gives computed normalized AOA transfer functions based on the formula: $\text{phase}(A + jB - C - jD)$. These transfer functions would characterize the performance of the AOA antenna if there were no mutual coupling and if the difference in the insertion phases γ and δ were 90 degrees.

The AOA transfer function is the relationship between

Input = actual bearing from which a radio wave is arriving, clockwise (as seen from above) positive, with zero in the forward direction.

Output = $\text{phase}(\delta/\sigma)$

Because of the notation convention given above, the output is negative when δ is delayed with respect to σ .

A.2 Antenna By Itself

For the case of a top antenna having no reflecting objects in the vicinity and no mutual coupling between monopoles, the geometry diagramed in Fig. A-3 leads to the formulas for A, B, C, and D given in that figure. These formulas allow the output to be computed for any value of bearing. Such computations have been carried out, resulting in the normalized AOA transfer function plotted in Fig. A-4.

This is seen to be monotonic, of positive slope, and approximately linear. The "offset" (which is defined to be the difference between output and input at a true bearing of zero degrees) is 135°.

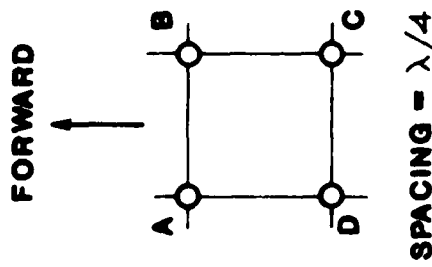
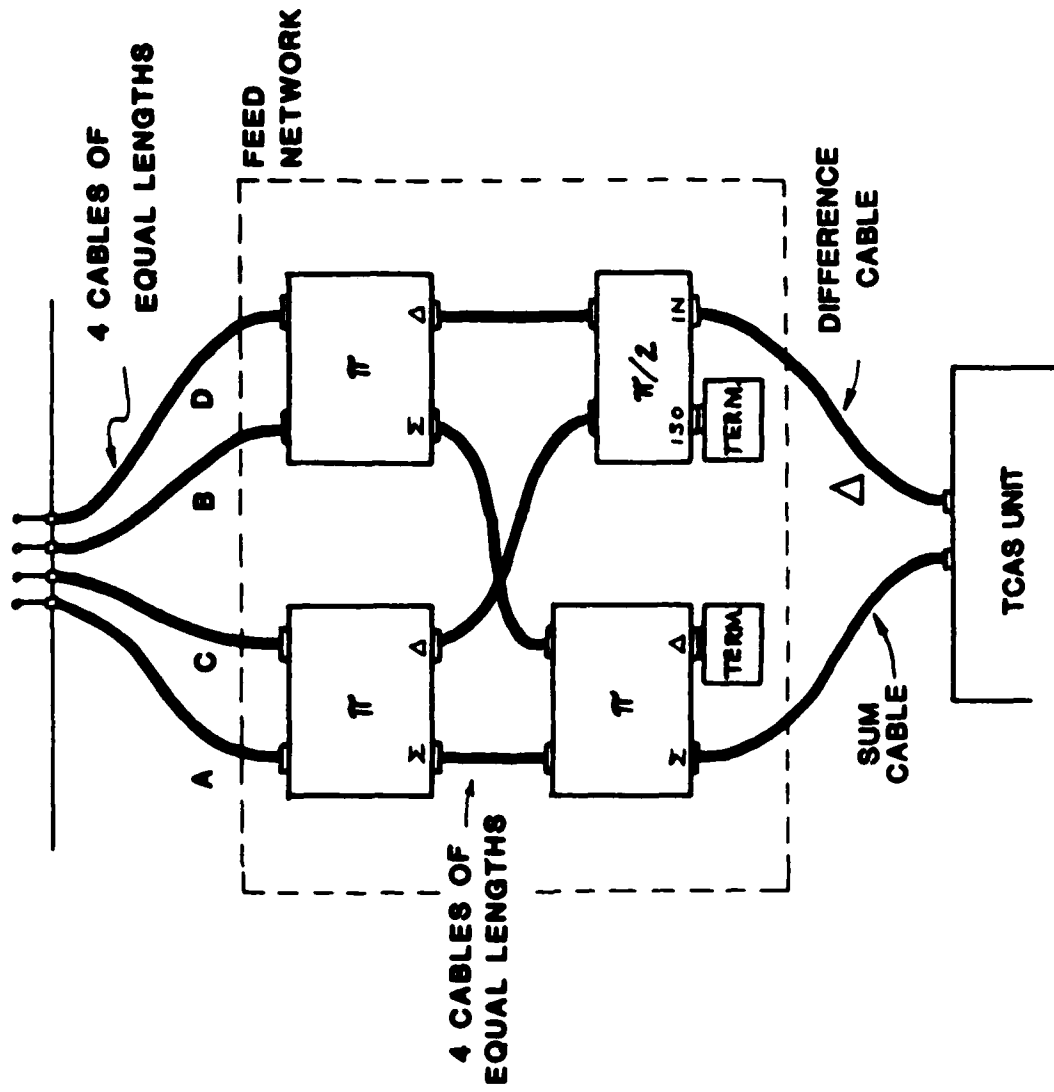

A-2

Fig. A-1. Standard form of the AOA antenna.

100000

Assumed characteristics of individual hybrids

(where γ , δ , η , ν are constants representing the insertion phases and insertion losses of the hybrids)

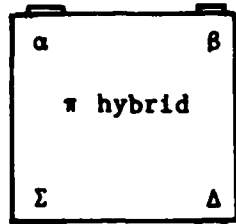

- α to Σ : $\eta e^{j\gamma}$
- β to Σ : $\eta e^{j\gamma}$
- α to Δ : $\eta e^{j(\gamma - \pi/2)}$
- β to Δ : $\eta e^{j(\gamma + \pi/2)}$

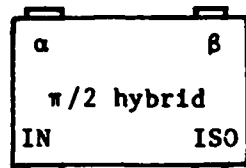

- α to IN: $\nu e^{j(\delta + \pi/2)}$
- β to IN: $\nu e^{j\delta}$
- α to ISO: $\nu e^{j\delta}$
- β to ISO: $\nu e^{j(\delta + \pi/2)}$

For the network of Fig. 1 (ignoring matched cables):

- A to Σ = $\eta^2 e^{j(2\gamma)}$
 - B to Σ = $\eta^2 e^{j(2\gamma)}$
 - C to Σ = $\eta^2 e^{j(2\gamma)}$
 - D to Σ = $\eta^2 e^{j(2\gamma)}$
 - A to Δ = $\eta \nu e^{j(\gamma + \delta - \pi/2)}$
 - B to Δ = $\eta \nu e^{j(\gamma + \delta)}$
 - C to Δ = $\eta \nu e^{j(\gamma + \delta + \pi/2)}$
 - D to Δ = $\eta \nu e^{j(\gamma + \delta + \pi)}$
- $$\Sigma = \eta^2 e^{j(2\gamma)} [A + B + C + D]$$
- $$\Delta = \eta \nu e^{j(\gamma + \delta - \pi/2)} [A + jB - C - jD]$$

$$\frac{\Delta}{\Sigma} = \frac{\nu}{\eta} e^{j(\delta - \gamma - \pi/2)} \frac{A + jB - C - jD}{A + B + C + D}$$

Since $A+B+C+D$ is real and positive when referenced to a reception at the center point of the array:

$$\text{phase}(\Delta/\Sigma) = \text{phase}(e^{jF}(A + jB - C - jD))$$

where

$$F = \delta - \gamma - \pi/2.$$

Fig. A-2. AOA antenna analysis.

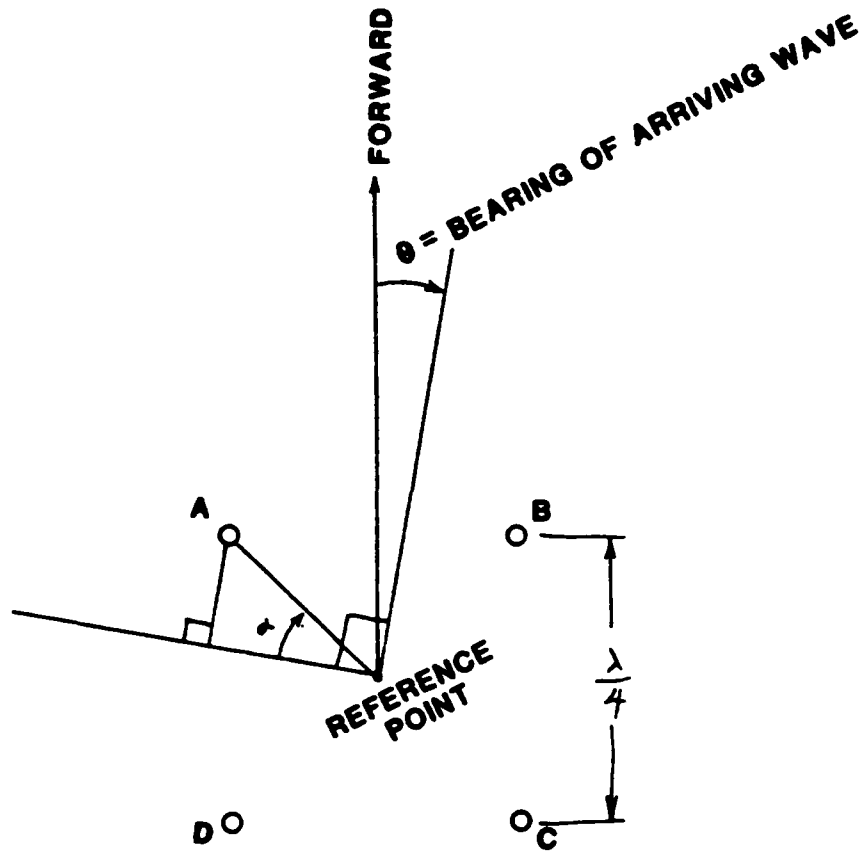

$$A = e^{j(\pi/2 - 2)\sin \alpha}$$

$$B = e^{j(\pi/2 - 2)\sin (\alpha + \pi/2)}$$

$$C = e^{j(\pi/2 - 2)\sin (\alpha + \pi)}$$

$$D = e^{j(\pi/2 - 2)\sin (\alpha + 3\pi/2)}$$

where $\alpha = \pi/4 - \theta$

Fig. A-3. Analysis of performance in the absence of reflectors and in the absence of mutual coupling between array elements.

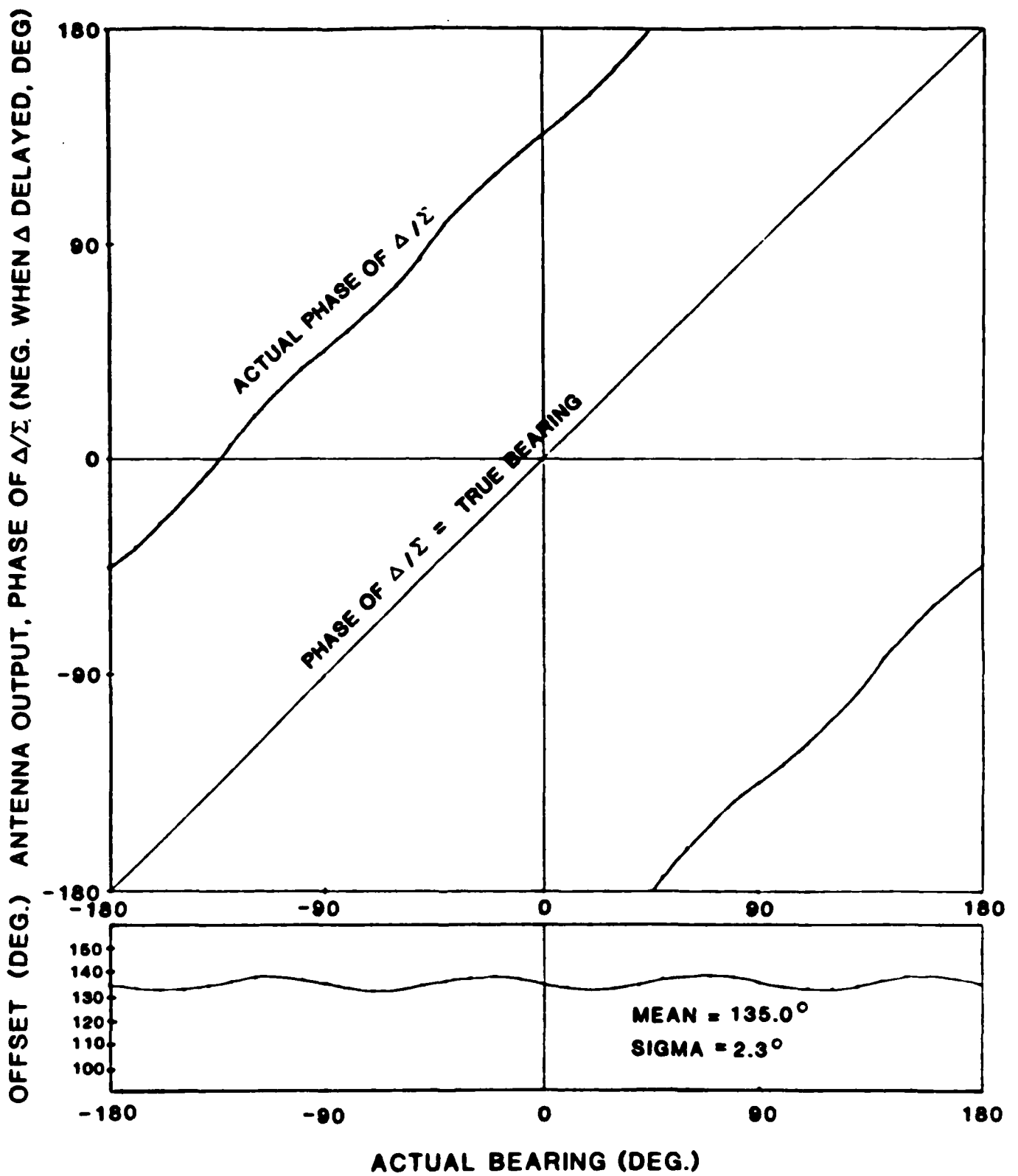

Fig. A-4. Calculated antenna performance in the absence of reflectors.

Deviations from a constant offset are of interest because the simplest realization of the bearing processor merely adds a constant to the measured phase (δ/σ). This constant is selected to cancel the average offset of the antenna transfer function. Thus if the constant is properly chosen, the deviations from the average constitute the inherent inaccuracies of the bearing measurements.

The shape of the offset deviation in Fig. A-4 is seen to be approximately sinusoidal, with four cycles per revolution. This is called "quadrantal error". These deviations have peak values of $\pm 3.2^\circ$, and have a standard deviation of 2.3° .

A.3 Antenna Plus Reflector

Another case calculated included a reflector near the AOA antenna, to represent, for example, the main rotor mast of the helicopter. The reflector is located directly aft of the antenna, and is characterized by its distance, L , from the antenna and a reflection coefficient, ρ . This geometry is diagramed in Fig. A-5.

For analysis purposes, the reflection is treated as if it were a plane wave impinging on the antenna. The antenna outputs, δ and σ , are calculated as the sum of two components: a direct component and a reflected component, where the latter arrives from bearing = 180° , has amplitude ρ times the amplitude of the direct component, and has a phase delay given by the additional path length of the reflection.

On the Ranger helicopter, the rotor mast is 39 inches aft of the AOA antenna. Correspondingly, computations were carried out for the case $L = 39$, $\rho = -0.2$. The value of ρ was selected arbitrarily. The resulting transfer function is plotted in Fig. A-6.

These results show that the reflector produces a significant effect on AOA accuracy. The transfer function is no longer monotonic. It includes an oscillatory ripple, with errors being the largest on the left and right sides of the aircraft.

The offset characteristic has a qualitative left-right symmetry, and yet is not really symmetric in either the even sense or the odd sense.

The period of these oscillations is about 18° . For comparison, the on-the-helicopter transfer function (Fig. 4-8) exhibits oscillations having a period of about 35° . This discrepancy between model and measurement is significant and suggests that other reflecting objects on the helicopter may be more significant than the rotor mast. Among the metal objects near the antenna (Fig. 4-11) the hydraulic reservoir may be significant because it is relatively close to the antenna. It is 20 inches aft of the antenna, which is about half the distance to the rotor shaft.

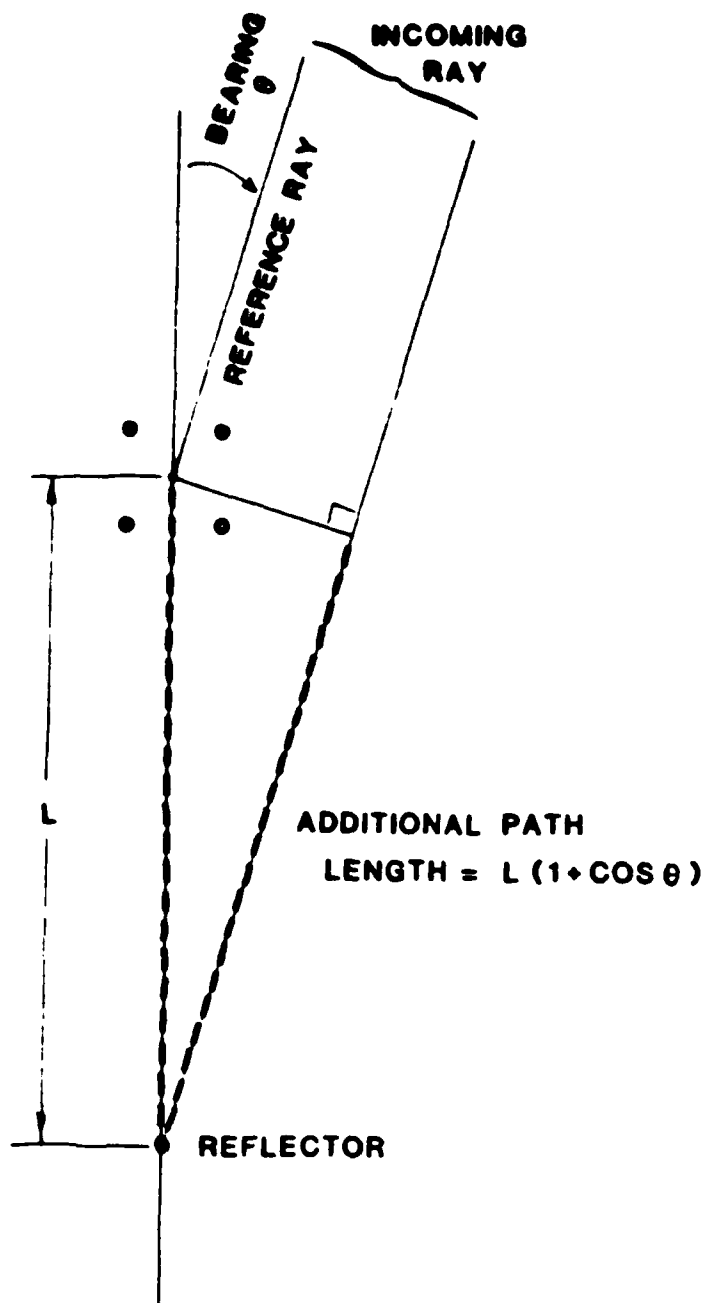

Fig. A-5. Geometry of reflection calculation.

AD-A181 349

TRAFFIC ALERT AND COLLISION AVOIDANCE SYSTEM (TCAS)
SURVEILLANCE PERFORMANCE (U) MASSACHUSETTS INST OF TECH
LEXINGTON LINCOLN LAB W H HARMAN ET AL 08 MAY 87

2/2

UNCLASSIFIED

ATC-135 DOT/FAR/PN-85/29 DOT-FA77WAI-817

F/G 1/4

NL



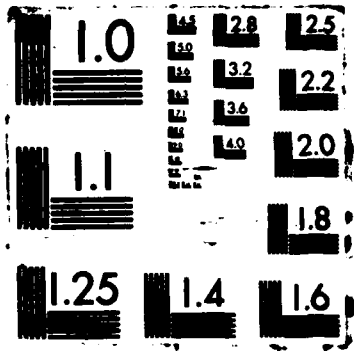

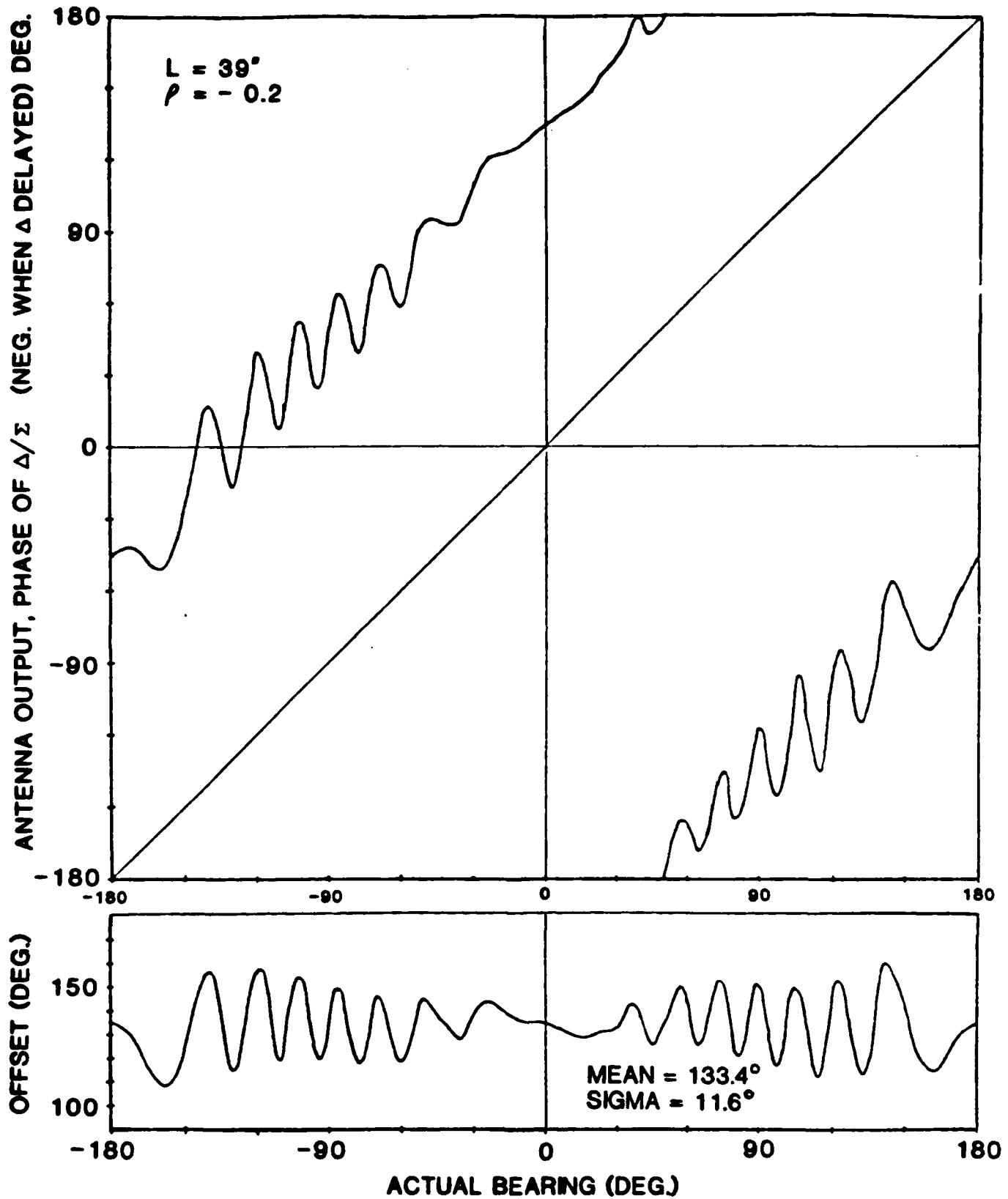

Fig. A-6. Calculated antenna performance with reflector 39 inches away.

Corresponding to the hydraulic reservoir, the transfer function was calculated for a reflector at a distance $L = 20''$ and with reflection coefficient $\rho = -0.2$. The resulting transfer function is plotted in Fig. A-7.

Here too the transfer function exhibits a large oscillatory error, primarily to the left and right. In this case the period of oscillation is about 33° , which corresponds much more closely to the AOA behavior observed on the helicopter.

A.4 Anechoic Chamber Measurements

Measurements of the performance characteristics of the 4-element AOA antenna were conducted in an anechoic chamber. These measurements were made for several reasons:

- to determine the gain of the antenna relative to a monopole,
- to determine the effect on antenna gain of having the monopoles insulated from the ground plane. This result is of interest because, the array monopoles installed on actual aircraft are often not adequately connected to the metal aircraft skin because of the presence of anti-corrosion paint.
- to determine the effects of mutual coupling on the offset and on the deviations from a constant offset.

A.4.1. Gain Measurements

The AOA antenna was mounted on an aluminum circular ground plane of 4 ft. diameter for these tests. For absolute gain comparisons, tests were also conducted on a single monopole and on a standard gain horn. The characteristics of the antennas tested are summarized in Fig. A-8.

The resulting measurements of antenna gain are given in Fig. A-9. From these results the following observations are made:

(1) The elevation patterns of the monopole and the 4-element array are found to differ significantly from that of an ideal monopole on an infinite ground plane. This comparison is plotted in Fig. A-10. The difference presumably arises from the circular ground plane. The measured patterns may be described as having a large ripple superimposed on the ideal pattern.

(2) The absolute gain of the monopole can be determined by comparison with a standard gain horn. Since the peak gain of the horn at 1090 MHz is 12.1 dBi and the monopole peaks 6 dB below this, it follows that the absolute gain of the monopole at the peak is 6.1 dBi. This result can be checked for reasonableness by integrating the gain in all directions, which should yield a value near 1 (or zero dBi) since a monopole is essentially loss-free. The appropriate integral is of the form:

$$\text{Average gain} = \frac{1}{2} \int_{-\pi/2}^{+\pi/2} G(E) \cos(E) dE$$

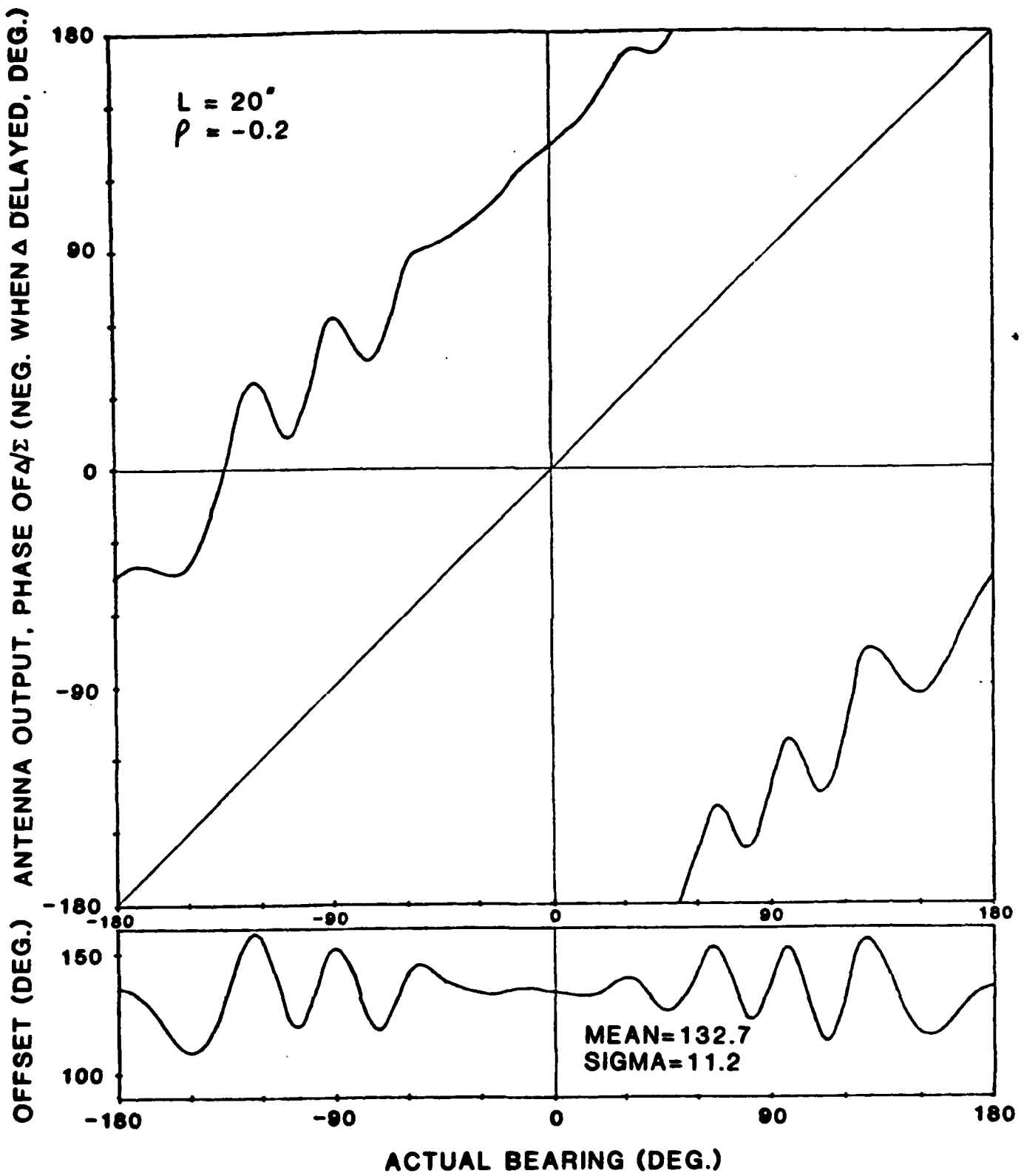
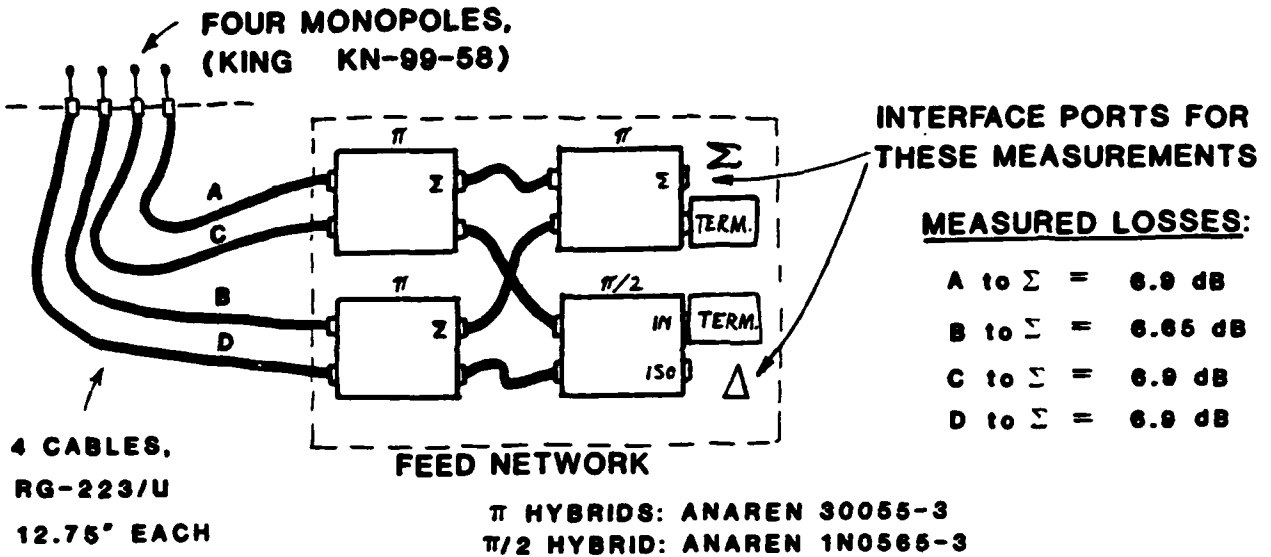
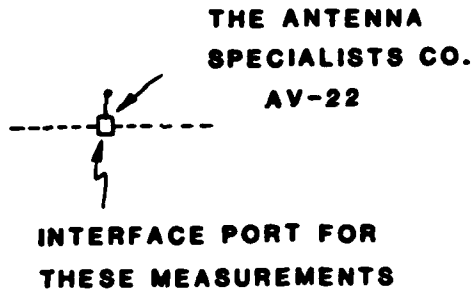

Fig. A-7. Calculated antenna performance with reflector 20 inches away.

AOA Antenna



Monopole



Standard Gain Horn

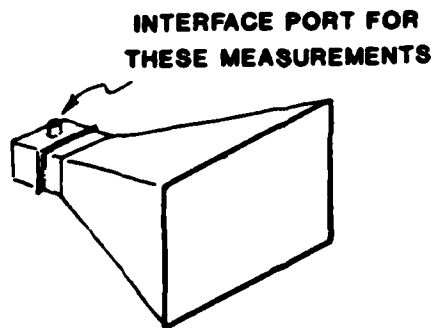

American Electronics Laboratory
H-5000

Gain = 11.8 dBi at 1030 MHz
12.1 dBi at 1090 MHz

Beamwidth = 52°, horizontal, 1030 MHz.
52°, vertical, 1030 MHz.
50°, horizontal, 1090 MHz.
50°, vertical, 1090 MHz.

Fig. A-8. Characteristics of the antennas tested.

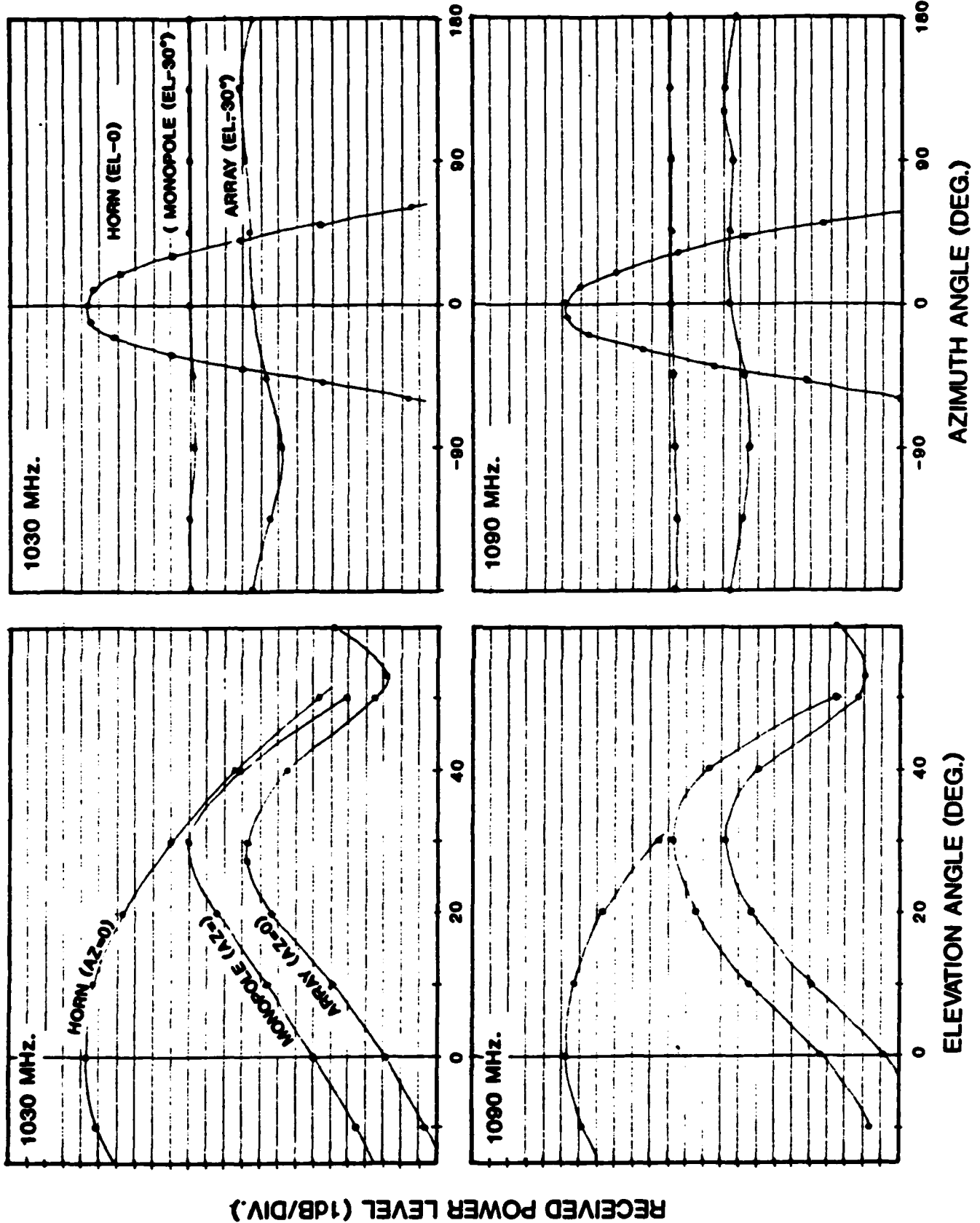

Fig. A-9. Measured antenna patterns.

100640

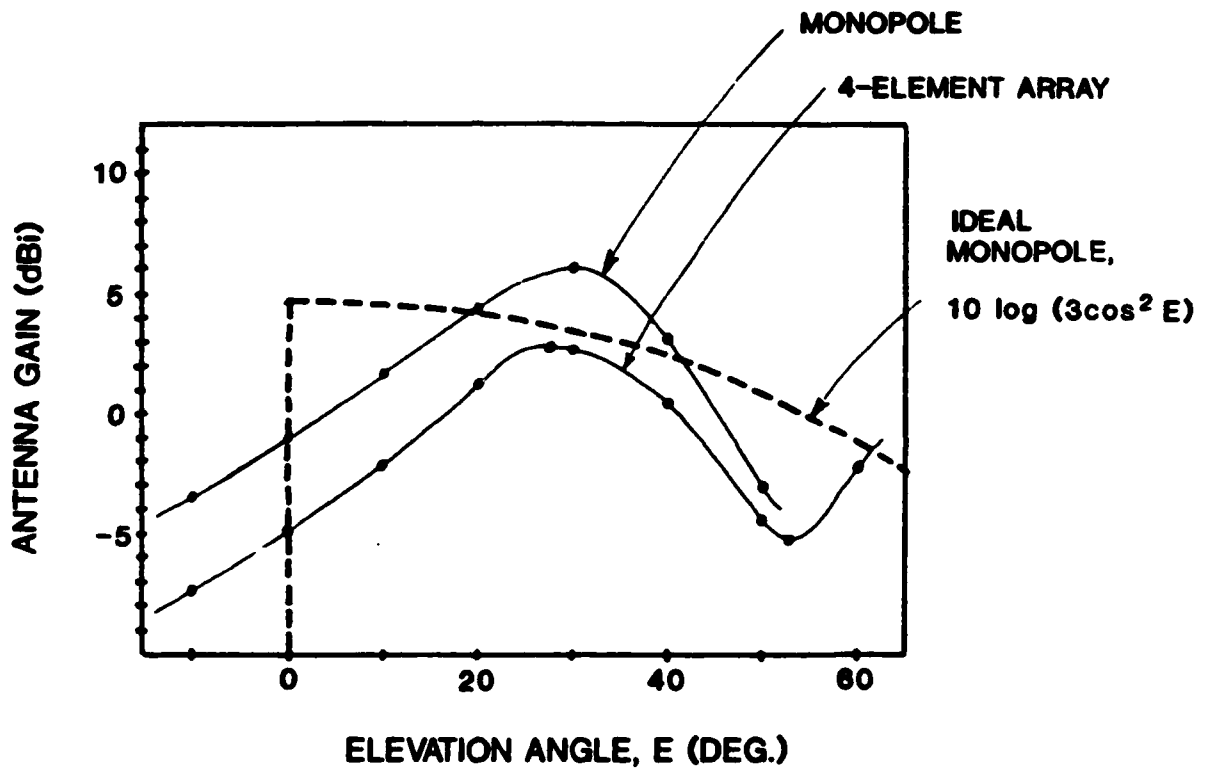

Fig. A-10. Measured elevation patterns compared with the ideal.

where G = gain (not in dB) and E = elevation angle. Carrying out the integration yields an average gain value of 1.13 or +0.5 dBi. This value is entirely reasonable, and serves to add confidence to the anechoic chamber measurements.

(3) The gain of the 4-element array is best given relative to the gain of the monopole, since both antennas are affected by the circular ground plane in about the same way. Based on average gains, the two antennas compare as follows.

Array aver. gain	0.496 = -3.0 dB at 1030 MHz

Monopole aver. gain	0.493 = -3.1 dB at 1090 MHz

Thus the 4-element array is lower in gain relative to a monopole by about 3 dB and has otherwise approximately the same gain pattern. Part of this 3 dB loss can be attributed to ohmic losses in the hybrids and cables used in the feed network. For ideal loss-free hybrids and cables, the insertion loss between a single monopole and the sigma output would be exactly 6 dB, whereas the measured insertion loss is approximately 7 dB (Fig. 4-22). Thus the actual hybrids and cables contribute a loss of about 1 dB. The remaining 2 dB of loss relative to a monopole antenna can be thought of as an "array factor". Physically, the lost power may be associated with an impedance mismatch caused by mutual coupling.

A.4.2 Antenna Ground Effects

Having completed these basic measurements to characterize the antenna itself on an idealized ground plane, the effects of the ground connections were then explored. For comparison with the data given above, gain was measured under the same conditions except with the monopoles insulated from the ground plane. The results indicate that both the gain pattern and the AOA transfer function were essentially unchanged when the monopoles were insulated from the ground plane. This behavior is a result of capacitive coupling, which at these radio frequencies is sufficient to bring about effective antenna performance even if a thin insulating layer (such as paint) is present between the antenna and the metal ground plane.

A.4.3 Offset Measurements

The AOA transfer function was measured with the AOA antenna mounted on the 4-ft circular ground plane. The lengths of the sum and difference cables were adjusted to compensate for the difference in insertion phase between the π hybrids and the $\pi/2$ hybrid. Referring to Fig. A-2, it is seen that the phase factor F can be made equal to zero if the difference between γ (the insertion phase of the π hybrid) and δ (the insertion phase of the $\pi/2$ hybrid) is made equal to 90 degrees. This can be accomplished physically by adjusting the length of the cable out of the $\pi/2$ hybrid (the Difference cable) such that the phase measured between input port "A" and the output of the Difference cable is equal to the phase measured between "A" and the output of the Sum cable.

APPENDIX B

LOWER-COST TECHNIQUES FOR HELICOPTER TCAS

B.1 Relationship Between TCAS Type and Cost

TCAS equipment is classified according to the nature of the advisories it provides. TCAS I provides traffic advisories only. TCAS II adds vertical resolution advisories, and TCAS III adds horizontal resolution advisories. As pointed out in Section 1, TCAS I is the most appropriate type of TCAS for helicopter use from an operational standpoint. The cost, weight, and complexity of TCAS equipment decreases significantly when resolution advisory capability is not required. There are several reasons for this: less complex advisory logic can be used. The surveillance range and accuracy can be decreased to match the less rigorous requirements of visual surveillance. And less rigid certification standards can be used.

Thus, TCAS I equipment is inherently less costly than TCAS II or TCAS III equipment. This cost difference has caused TCAS I to be associated primarily with general aviation installations. As a consequence, techniques have been considered for further reducing the cost of TCAS I equipment by reducing transmitted power, simplifying its interference limiting procedures, and simplifying its surveillance functions in other ways.

Functional guidelines for low-cost TCAS I equipment were published by the Radio Technical Commission on Aeronautics (RTCA) in 1983 (Ref. 1). However, the TCAS I interference limiting procedures outlined in Ref. 1 restricted TCAS I performance to a level that is likely to be inadequate for the surveillance environment experienced by rotorcraft. Thus, although the low cost and relative simplicity of TCAS I equipment defined in Ref. 1 would be attractive for helicopter applications, the performance would probably be unsatisfactory.

B.2 Medium-cost TCAS I

Near the end of the experimental activities reported here, significant changes were proposed for the RTCA TCAS I standards. The RTCA Special Committee on TCAS (SC-147) is currently developing a Minimum Operational Performance Standard (MOPS) that will allow significantly higher power levels than the low-cost standard (Ref. 1), and will result in improved surveillance performance from TCAS I equipment operating in low-to medium-density airspace.

The principal area of change lies in the procedure for limiting interference to other systems operating in the beacon band. Medium-cost TCAS I equipment will monitor the activity in the beacon band so that it may transmit significantly higher average power interrogations when the interference environment is light. As the interference environment increases, TCAS I equipment will gradually reduce its average power or interrogation rate (or both).

Although such a medium-cost TCAS surveillance design was not evaluated directly in this study, it is possible to infer certain aspects of its performance in a helicopter indirectly from the helicopter flight test data obtained from a more capable TCAS design.

B.3 Surveillance Disadvantages of Medium-cost TCAS I Relative to the Equipment Tested

There are several important differences between a medium-cost TCAS I and the equipment tested that affect surveillance performance.

In medium-cost TCAS I equipment the average power will be cut back in high interference environments both by decreasing the peak transmitted power and by decreasing the interrogation update rate from a nominal rate of one update per second to one every four or five seconds. As a result of the lower update rate, a failure of the medium-cost TCAS I to elicit a reply from an aircraft in a given update period could result in an 8- or 10-second detection delay or period of lost contact.

A second disadvantage is that medium-cost TCAS I does not track Mode S targets separately. All targets are tracked by means of Mode C interrogations, so there is no opportunity to employ Mode S reinterrogations to compensate for update failures.

A third disadvantage is that medium-cost TCAS I reduces its average power by employing a whisper-shout sequence that is less dense than in the unit tested. Thus, the medium-cost TCAS I whisper-shout sequence provides fewer interrogations per target per update period than does the sequence tested here.

The rotor blockage problem discussed in Section 3.3.3 is known to cause random update failures. The consequences of such update failures are clearly more serious as the medium-cost TCAS I equipment is constrained to transmit at a lower interrogation repetition rates.

The combined result of these three effects is that the medium-cost TCAS I track reliability is expected to be more severely degraded by main rotor reflections than is the design tested, especially when the interference environment calls for a reduction in transmitted power.

The airframe blockage problem discussed in Section 3.5.2 is known to cause blind spots for targets below and aft. Because of its reduced power relative to the design tested, a medium-cost TCAS I will experience even larger blind regions for targets below and aft. Thus, for those rotorcraft applications in which there is particular concern for intruders approaching from such blind directions, a TCAS design comparable to the equipment tested here is to be preferred.

It is not possible to design a whisper-shout sequence that results in very low average power but includes sufficient steps to cover a wide range of target effective interrogation sensitivities. Because helicopters often fly in close proximity to each other, multiple targets will sometimes reply to the lowest power whisper-shout interrogation. As a result, there will be more synchronous garble and near-by targets with low reply powers will tend to be discriminated against by the TCAS dynamic thresholding circuitry (which must be retained to help in overcoming multipath).

B.4 Conclusions

The new RTCA minimum standard for TCAS I equipment will likely provide sufficient track reliability and bearing estimation performance to support a useful traffic advisory service in helicopters that normally fly in low interference environments.

In high interference environments, a medium-cost TCAS I surveillance design will not provide as reliable surveillance performance in the rotorcraft environment as in the fixed-wing environment because a) its lower interrogation rate makes it more susceptible to scattering from the main rotor, b) its lower transmitted power makes it more susceptible to blockage by the more complex rotorcraft airframe, and c) its whisper-shout design may not provide sufficient discrimination between near-by targets.

END

7-87

Dttic