

*Engineering*  
*Electrical Engineering fields*

---

Okayama University

Year 1993

---

Trends in active power line conditioners

Hirofumi Akagi  
Okayama University

This paper is posted at eScholarship@OUDIR : Okayama University Digital Information Repository.

[http://escholarship.lib.okayama-u.ac.jp/electrical\\_engineering/60](http://escholarship.lib.okayama-u.ac.jp/electrical_engineering/60)

# Trends in Active Power Line Conditioners

Hirofumi Akagi, *Member, IEEE*

**Abstract**—Active power line conditioners, which are classified into shunt and series ones, have been studied with the focus on their practical installation in industrial power systems. In 1986, a combined system of a shunt active conditioner of rating 900 kVA and a shunt passive filter of rating 6600 kVA was practically installed to suppress the harmonics produced by a large capacity cycloconverter for steel mill drives. More than one hundred shunt active conditioners have been operating properly in Japan. The largest one is 20 mVA, which was developed for flicker compensation for an arc furnace with the help of a shunt passive filter of 20 mVA.

In this paper, the term of “active power line conditioners” would be used instead of that of “active power filters” because active power line conditioners would cover a wider sense than active power filters. The primary intent of this paper is to present trends in active power line conditioners using PWM inverters, paying attention to practical applications.

## I. INTRODUCTION

RAPID variation of reactive power generated by arc furnaces, and harmonics produced by diode or thyristor rectifiers have been serious as they have caused flicker or harmonic interference in industrial applications and transmission/distribution systems. So far, shunt passive filters, which consist of tuned LC filters and/or high-pass filters, have been used to improve power factor and to suppress harmonics in power systems. However, shunt passive filters have such problems as to discourage their applications. A shunt passive filter exhibits lower impedance at a tuned harmonic frequency than the source impedance to reduce the harmonic currents flowing into the source. In principle, filtering characteristics of the shunt passive filter are determined by the impedance ratio of the source and the shunt passive filter. Therefore, the shunt passive filter has the following problems.

- The source impedance, which is not accurately known and varies with the system configuration, strongly influences filtering characteristics of the shunt passive filter.
- The shunt passive filter acts as a sink to the harmonic current flowing from the source. In the worst case, the shunt passive filter falls in series resonance with the source impedance.
- At a specific frequency, an antiresonance or parallel resonance occurs between the source impedance and the shunt passive filter, which is the so-called harmonic amplification.

Active power line conditioners, which are classified into shunt and series ones, have been studied to compensate for reactive power, negative-sequence, harmonics, and/or flicker in

Manuscript received July 23, 1992; revised December 7, 1993.  
The author is with the Department of Electrical Engineering, Okayama University, Okayama-city 700, Japan.  
IEEE Log Number 9402437.

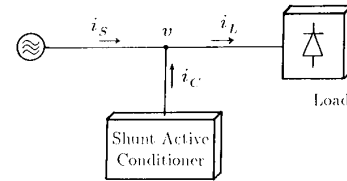

Fig. 1. Basic principle of shunt active power line conditioner.

industrial power systems since their basic compensation principles were proposed in the 1970's [1]–[3]. However, there was almost no advance in active power line conditioners beyond a laboratory testing stage, because circuit technology was too poor to practically implement the compensation principle in the 1970's. Over the last five to ten years, remarkable progress of fast switching devices such as bipolar junction transistors and static induction thyristors has spurred interest in the study of shunt and series active power line conditioners for reactive power and harmonic compensation [4]–[11]. In addition to sophisticated PWM inverter technology, the development of the so-called “p-q theory” [12] has made it possible to put them into a practical testing stage.

In 1982, a shunt active conditioner of 800 kVA, which consisted of current-source PWM inverters using GTO thyristors, was put into practical use for harmonic compensation for the first time in the world. At present, the purpose of shunt active conditioners is to compensate for reactive power, negative-sequence, harmonics, and/or flicker. Moreover, attention is paid to the combined system of an active power line conditioner and a shunt passive filter to reduce initial costs and to improve efficiency.

In this paper, trends and future prospects in active power line conditioners are presented with the focus on practical applications.

## II. SHUNT ACTIVE POWER LINE CONDITIONERS

### A. Compensation Principle

Fig. 1 shows the basic principle of a shunt active conditioner, which is controlled in a closed loop manner to actively shape the source current  $i_s$  into the sinusoid. Fig. 2 shows each waveform in such a case that the load is assumed to be a three-phase diode rectifier with an inductive load.

The shunt active conditioner injects the compensating current  $i_c$  into the source to cancel the harmonics contained in the load current  $i_L$ . Accordingly, a finite amount of impedance in the power system, which is usually predominantly inductive, seldom influences the filtering characteristics because the harmonic-producing load can be considered a current source

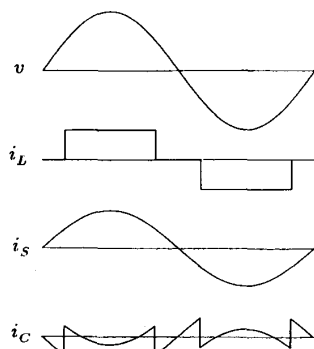

Fig. 2. Theoretical waveforms in Fig. 1.

due to the presence of sufficient inductance on the dc side of a diode or thyristor rectifier.

To put the shunt active conditioner into practical use, however, the followings have to be solved.

- Which voltage and/or current of  $v$ ,  $i_S$  and  $i_L$  in Fig. 1 should we detect?
- How should we decide or calculate the command of the compensating current from the detected voltage and/or current? It is difficult to do it, especially in transient states or in such a case that  $i_L$  is always fluctuating.
- How should we realize a large capacity non-sinusoidal current source with rapid current response which can follow its command?

### B. Power Circuits

There are two types of power circuits in a shunt active conditioner as shown in Figs. 3 and 4. These are the same in the power circuits as a current source PWM inverter and a voltage source PWM inverter for ac motor drives. They are, however, different in their behavior because the shunt active conditioner acts as a non-sinusoidal current source. The current or voltage source PWM inverter which are used as a shunt active conditioner needs a dc reactor or a dc capacitor which plays an essential role as an energy storage element but it does not need any dc power supply on the dc side. The reason is that the shunt active conditioner can be controlled so as to supply the losses in the PWM inverter from the ac source. The author prefers the voltage source PWM inverter to the current source PWM inverter because the voltage source PWM inverter is higher in efficiency and lower in initial cost than the current source PWM inverter. In fact, almost all shunt active conditioners, which have been put into practical use in Japan, have adopted the voltage source PWM inverter as the power circuit.

Table I shows switching devices, ratings and specifications of typical shunt active conditioners, which have been already put into practical use in Japan. Table II shows the comparison of losses of 100 kVA shunt active conditioners using GTO thyristors, BJT's, or IGBT's, which are installed to the three-phase 400-V power system [13].

### C. Control Strategies and Filtering Characteristics

Transformation of the three-phase voltages  $v_u$ ,  $v_v$ , and  $v_w$  and the three-phase load currents  $i_{Lu}$ ,  $i_{Lv}$ , and  $i_{Lw}$  into the

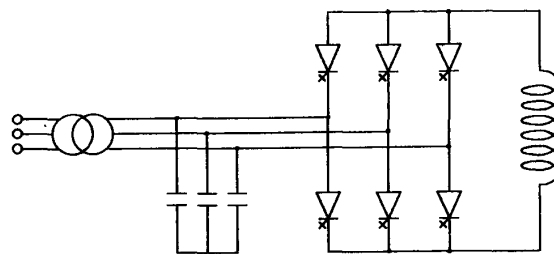

Fig. 3. Current-source PWM inverter.

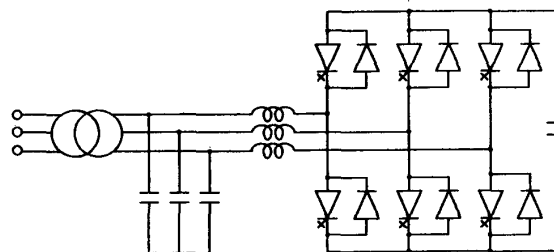

Fig. 4. Voltage-source PWM inverter.

$\alpha - \beta$  orthogonal coordinates gives the following expressions:

$$\begin{bmatrix} v_\alpha \\ v_\beta \end{bmatrix} = \sqrt{\frac{2}{3}} \begin{bmatrix} 1 & -1/2 & -1/2 \\ 0 & \sqrt{3}/2 & -\sqrt{3}/2 \end{bmatrix} \begin{bmatrix} v_u \\ v_v \\ v_w \end{bmatrix} \quad (1)$$

$$\begin{bmatrix} i_{L\alpha} \\ i_{L\beta} \end{bmatrix} = \sqrt{\frac{2}{3}} \begin{bmatrix} 1 & -1/2 & -1/2 \\ 0 & \sqrt{3}/2 & -\sqrt{3}/2 \end{bmatrix} \begin{bmatrix} i_{Lu} \\ i_{Lv} \\ i_{Lw} \end{bmatrix} \quad (2)$$

According to the p-q theory [12], the instantaneous real power  $p_L$  and the instantaneous imaginary power  $q_L$  on the load side are defined as

$$\begin{bmatrix} p_L \\ q_L \end{bmatrix} = \begin{bmatrix} v_\alpha & v_\beta \\ -v_\beta & v_\alpha \end{bmatrix} \begin{bmatrix} i_{L\alpha} \\ i_{L\beta} \end{bmatrix} \quad (3)$$

The instantaneous powers  $p_L$  and  $q_L$  are divided into three components, respectively.

$$p_L = \bar{p}_L + \hat{p}_L + \tilde{p}_L \quad (4)$$

$$q_L = \bar{q}_L + \hat{q}_L + \tilde{q}_L \quad (5)$$

where

$$\begin{array}{ll} \bar{p}_L, \bar{q}_L & : \text{dc components} \\ \hat{p}_L, \hat{q}_L & : \text{low-frequency components} \\ \tilde{p}_L, \tilde{q}_L & : \text{high-frequency components.} \end{array}$$

The "dc," "low frequency," and "high frequency" are not strict in an electrical engineering sense. They become strict after designing the cut-off frequency of high-pass filters which are used for the extraction of  $\bar{p}_L$ ,  $\hat{p}_L$ ,  $\tilde{p}_L$ ,  $\bar{q}_L$ ,  $\hat{q}_L$ , and  $\tilde{q}_L$  from  $p_L$  and  $q_L$ . The conventional active power is corresponding to

TABLE I  
APPLICATION EXAMPLES OF SHUNT ACTIVE POWER LINE CONDITIONERS IN JAPAN

Switching devices	Capacity of active conditioner	Ratings of switching devices	Circuit configuration of power circuit	Average switching frequency	Applications	Starting year
GTO thyristors	20MVA	4500V 3000A	Voltage-Source ( 1S-1P-12A ) × 6G	300Hz	Arc furnaces	'90
SI thyristors	200kVA	1200V 300A (average)	Voltage-Source ( 1S-1P-6A ) × 4G	5kHz	VVVF inverters	'88
BJT	500kVA	1200V 300A	Voltage-Source ( 1S-4P-6A ) × 5G	1.3kHz	Cycloconverters for steel mill drives	'87
IGBT	100kVA	1000V 100A	Voltage-Source 1S-3P-6A	8kHz	Static power converters in building	'88

TABLE II  
LOSSES OF SHUNT ACTIVE POWER LINE CONDITIONERS OF 100 KVA

Switching Devices Circuit Configurations Average Switching Frequencies	GTO CSI-PWM 2kHz	BJT VSI-PWM 3kHz	IGBT VSI-PWM 8kHz
Switching Devices	2130W	2010W	2030W
Snubbers and Clippers	3010W	170W	500W
Gate Drive Circuits	560W	50W	20W
Filters	1180W	1370W	1040W
DC Reactor	1130W		
Transformers		890W	890W
Others	750W	710W	710W
Total	8760W	5200W	5190W

$\bar{p}_L$ , the conventional reactive power to  $\bar{q}_L$  and the negative-sequence to the  $2f$  frequency component of  $p_L$  and  $q_L$ . Here,  $f$  is the source frequency.

The commands of three-phase compensating currents injected by the shunt active conditioner,  $i_{Cu}^*$ ,  $i_{Cv}^*$  and  $i_{Cw}^*$  are given by the following.

$$\begin{bmatrix} i_{Cu}^* \\ i_{Cv}^* \\ i_{Cw}^* \end{bmatrix} = \sqrt{\frac{2}{3}} \begin{bmatrix} 1 & 0 \\ -1/2 & \sqrt{3}/2 \\ -1/2 & -\sqrt{3}/2 \end{bmatrix} \begin{bmatrix} v_\alpha & v_\beta \\ -v_\beta & v_\alpha \end{bmatrix}^{-1} \begin{bmatrix} p^* \\ q^* \end{bmatrix} \quad (6)$$

where

- $p^*$  : instantaneous real power command
- $q^*$  : instantaneous imaginary power command.

Which terms on the right-hand side of (4) and (5) are substituted into  $p^*$  and  $q^*$  of (6) decides the function of the shunt active conditioner. In other words, the shunt active conditioner can compensate for not only harmonics but also reactive power and negative-sequence component in accordance with its compensating objectives.

Table III shows the relation among compensating objectives, the order and cutoff frequency of high-pass filters, and the capacity of energy storage components such as dc reactors or dc capacitors. Figs. 5–8 show the experimental filtering characteristics of a shunt active conditioner using quad-series voltage source PWM inverters of rating 7 kVA [5], which correspond to Table III.

To discuss the filtering characteristics in the transient states, the firing angle of a three-phase thyristor rectifier of rating 20 kVA is controlled so that the dc output current of the rectifier,  $i_d$  is fluctuating at 10 Hz in Figs. 5–7. In these figures,  $v_{Su}$  is the source voltage in u-phase,  $i_d$  is the output dc current of the rectifier,  $i_{Lu}$  is the load current in u-phase, i.e., the input ac current of the rectifier in u-phase,  $i_{Su}$  is the source current in u-phase,  $i_{Cu}$  is the compensating current in u-phase, i.e., the injected current in u-phase by the shunt active conditioner, and  $v_{Cd}$  is the dc capacitor voltage of the shunt active conditioner. Since the shunt active conditioner operates properly, the source current is sinusoidal while the load current includes some amount of harmonic current. It is, however, difficult to distinguish the filtering characteristics in Fig. 6 from those in Fig. 7 with respect to the waveform of  $i_{Su}$ . Note that the dc capacitor voltage is constant in Fig. 6, while it is fluctuating at 10 Hz in Fig. 7. To eliminate the low frequency harmonic currents related to the component of 10 Hz present in  $\bar{p}_L$ , the dc capacitor has to absorb the variation of the energy stored in the dc reactor of the thyristor rectifier. This causes the variation of the dc capacitor voltage in Fig. 7. The shunt active conditioner needs a large capacity dc capacitor to suppress the variation. Accordingly, the shunt active conditioner which eliminates fully the low frequency harmonic currents caused by  $\bar{p}_L$  should be considered the energy storage system, the purpose of which is to smooth the energy variation [5].

In Fig. 8, the load is a single-phase thyristor rectifier whose firing angle is constant to verify compensation characteristics for harmonic and negative-sequence currents. The rectifier is connected between the u- and v-phases. In this figure,  $v_{Su}$  is the source voltage in u-phase,  $i_{Cu}$  is the compensating current in u-phase,  $i_{Su}$  is the source current in u-phase,  $i_{Sv}$  is the source current in v-phase,  $i_{Sw}$  is the source current in w-phase, and  $v_{Cd}$  is the dc capacitor voltage of the shunt active conditioner. Before the start of the shunt active conditioner, the source current in the u-phase,  $i_{Su}$  is identical to the load current in the u-phase,  $i_{Lu}$ , and no source current flows in the w-phase. After the start, the three-phase source currents are sinusoidal and balanced.

### III. COMBINED SYSTEMS

The shunt active power line conditioners consisting of PWM inverters have such a problem that they are inferior in initial cost and efficiency to shunt passive filters. Therefore, it is

TABLE III  
COMPENSATION OBJECTIVES BASED ON  $p^*$  AND  $q^*$

$p^*$ $q^*$ (cut-off frequency)	Compensation objectives	Energy storage components	Experimental examples
$p^* = \bar{p}_L$ (150Hz) $q^* = \bar{q}_L$ (150Hz)	Harmonic currents	Small capacity	Fig. 5
$p^* = \bar{p}_L$ (150Hz) $q^* = \bar{q}_L + \bar{q}_L$ (0.9Hz)	Harmonic currents and low frequency variation components of reactive power	Small capacity	Fig. 6
$p^* = \bar{p}_L + \bar{p}_L$ (0.9Hz) $q^* = \bar{q}_L + \bar{q}_L$ (0.9Hz)	Harmonic currents and low frequency variation components of active and reactive power	Large capacity	Fig. 7
$p^* = \bar{p}_L$ (0.9Hz) $q^* = \bar{q}_L$ (0.9Hz)	Harmonic currents and negative-sequence components	Medium capacity	Fig. 8

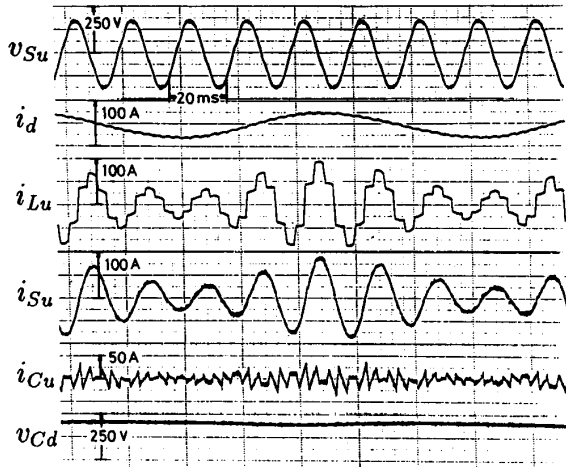

Fig. 5. Compensation for harmonic currents.

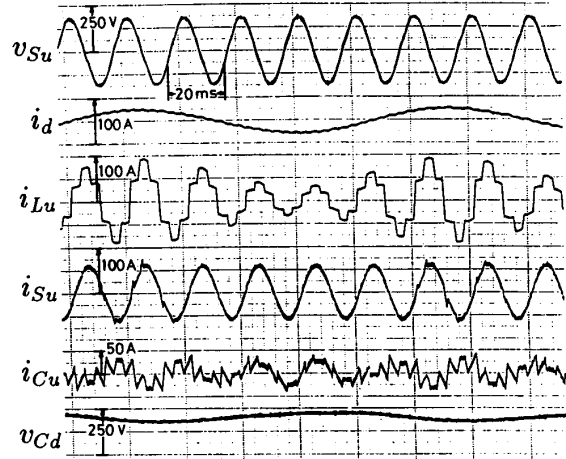

Fig. 7. Compensation for harmonic currents and low frequency variation components of active and reactive power.

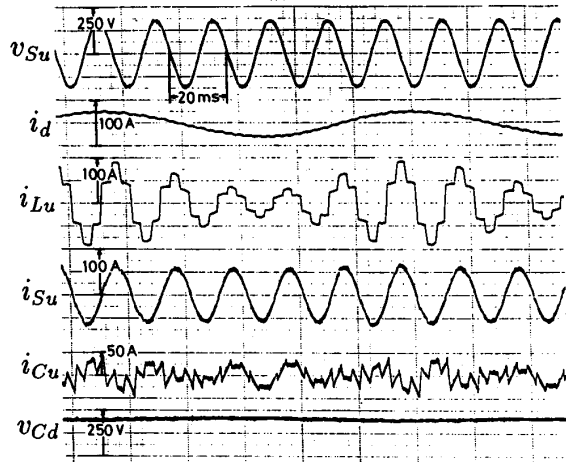

Fig. 6. Compensation for harmonic currents and low frequency variation components of reactive power.

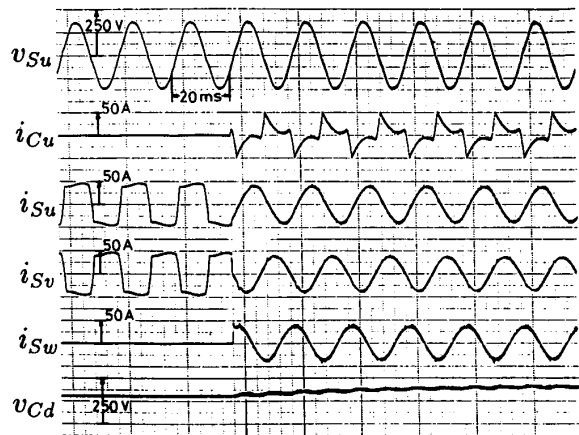

Fig. 8. Compensation for harmonic currents and negative-sequence components.

natural that attention has been paid to combined systems of active power line conditioners and shunt passive filters, which are classified into a combined system with shunt active conditioners [7] and that with series active conditioners [14].

Table IV shows the comparison between the two combined systems. There is a distinct difference in the function or role between the shunt and series active power line conditioners.

Fig. 9 shows a detailed system configuration of the combined system of a shunt passive filter of 10 kVA and a series

TABLE IV  
COMBINED SYSTEMS OF ACTIVE POWER LINE CONDITIONER AND SHUNT PASSIVE FILTER

	Combination with shunt active conditioner	Combination with series active conditioner
Circuit configuration		
Power circuit of active conditioner	<ul style="list-style-type: none"> <li>• Voltage source PWM inverter with current minor loop</li> </ul>	<ul style="list-style-type: none"> <li>• Voltage source PWM inverter without current minor loop</li> </ul>
Function of active conditioner	<ul style="list-style-type: none"> <li>• Harmonic compensator</li> </ul>	<ul style="list-style-type: none"> <li>• Harmonic isolator between source and load</li> </ul>
Advantages	<ul style="list-style-type: none"> <li>• Reduction in capacity of shunt active conditioner</li> <li>• Conventional shunt active conditioners applicable</li> </ul>	<ul style="list-style-type: none"> <li>• Great reduction in capacity of series active conditioner</li> <li>• Already existing shunt passive filters applicable</li> </ul>
Issues	<ul style="list-style-type: none"> <li>• Harmonic current may flow from source to shunt active conditioner</li> <li>• Compensating current injected by shunt active conditioner may flow into shunt passive filter</li> </ul>	<ul style="list-style-type: none"> <li>• Isolation and protection of series active conditioner</li> </ul>

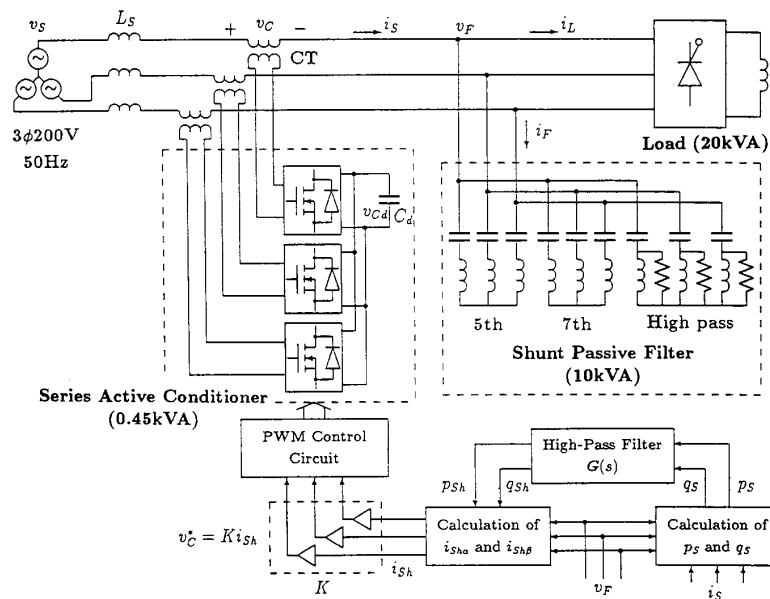

Fig. 9. Combined system of series active power line conditioner and shunt passive filter.

active conditioner of 0.45 kVA for harmonic compensation of a thyristor rectifier of 20 kVA. The function of the series active conditioner is not to directly compensate for the harmonics of the rectifier, but to improve the filtering characteristics of the shunt passive filter used alone. In other words, the series active conditioner acts not as a harmonic compensator but as a harmonic isolator between the power source and the thyristor rectifier. Fig. 10 shows the experimental waveforms before

and after the start of the series active conditioner. Before the series active conditioner was started, a parallel resonance at the fourth-harmonic frequency occurred in the system. A small amount of the fourth-harmonic current included in the load current was largely amplified. As a result, severe distortion existed in the source current,  $i_s$ , and the filter voltage,  $v_F$ . However, no parallel resonance appeared after the series active conditioner was started.

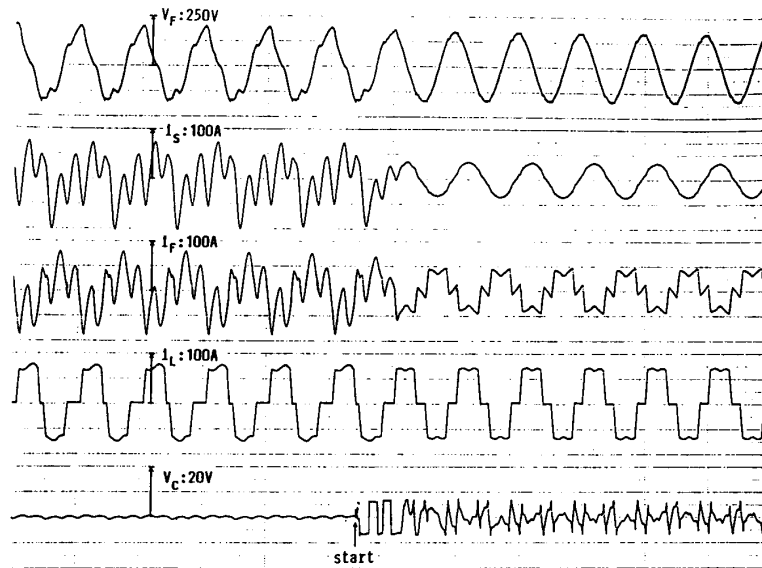

Fig. 10. Experimental waveforms in Fig. 9.

#### IV. FUTURE PROSPECTS

Active power line conditioners have been put on a commercial base in Japan by efforts of researchers and engineers on power electronics. There are the following future prospects of active power line conditioners on the basis of advances in switching devices and PWM inverter technology [13].

- The function of shunt active power line conditioners will be expanded from flicker compensation or voltage regulation into the improvement of stability in power systems as the capacity of shunt active power line conditioners becomes larger.
- The combined system of a small-rated series active power line conditioner and a shunt passive filter aims at reducing initial costs and improving efficiency, thus giving both practical and economical points of view. This system will be put into practical use in near future, considered a prospective alternative to shunt active power line conditioners for harmonic compensation of large capacity thyristor or diode rectifiers.

#### REFERENCES

- [1] H. Sasaki and T. Machida, "A new method to eliminate ac harmonic currents by magnetic compensation—Considerations on basic design," *IEEE Trans. Power Appl. Syst.* vol. PAS-90, p. 2009, 1971.
- [2] L. Gyugyi and E. C. Strycula, "Active ac power filters," in *IEEE/IAS Ann. Meeting*, 1976, pp. 529.
- [3] N. Mohan *et al.*, "Active filters for ac harmonic suppression," presented at IEEE/PES Winter Meeting, 1977.
- [4] H. Kawahira, T. Nakamura, and S. Nakazawa, "Active power filters," in *Proc. JIEE IPEC-Tokyo*, 1983, pp. 981.
- [5] H. Akagi, A. Nabae, and S. Atoh, "Control strategy of active power filters using multiple voltage-source PWM converters," *IEEE Trans. Ind. Appl.* vol. IA-22, pp. 460, May/June 1986.

- [6] K. Komatsugi and T. Imura, "Harmonic current compensator composed of static power converter," in *IEEE Power Electronics Specialist Conf.*, 1986, pp. 283.
- [7] M. Takeda *et al.*, "Harmonic current compensation with active filter," in *IEEE/IAS Ann. Meeting*, 1987, pp. 808.
- [8] A. Nakajima *et al.*, "Development of active filter with series resonant circuit" in *IEEE Power Electronics Specialist Conf.*, 1988, pp. 1168.
- [9] M. Kohata *et al.*, "Compensator for harmonics and reactive power using static induction thyristors," presented at European Conf. Power Electronics and Applications, 1987.
- [10] N. Watanabe *et al.*, "Application of active filter to UPS system," presented at Int. Symp. Power Electronics, Seoul, Korea, 1989.
- [11] Y. Tanoue, F. Aoyama, and K. Terashima, "5-mVA flicker suppression equipment—A hybrid system of a passive filter and an active filter using GTO thyristors," *Toshiba Rev.* vol. 43, no. 4, 1988.
- [12] H. Akagi, Y. Kanazawa, and A. Nabae, "Instantaneous reactive power compensators comprising switching devices without energy storage components," *IEEE Trans. Ind. Appl.* vol. IA-20, p. 625, 1984.
- [13] H. Akagi and N. Watanabe, "Present state and future trends of active power filters in Japan," in *Int. Symp. Power Electronics* Seoul, Korea, p. 445, 1992.
- [14] F. Z. Peng, H. Akagi, and A. Nabae, "A new approach to harmonic compensation in power systems—a combined system of shunt passive and series active filters," *IEEE Trans. Ind. Appl.* vol. 26, p. 983, 1990.



**Hirofumi Akagi** (M'87) received the B. S. degree from Nagoya Institute of Technology in 1974 and the M. S. and Ph. D. degrees from Tokyo Institute of Technology in 1976 and 1979, respectively, all in electrical engineering.

In 1979, he joined Nagaoka University of Technology as assistant and then associate professor in the electrical engineering department. In 1987, he was Visiting Scientist at the Massachusetts Institute of Technology for 10 months. Since 1991, he has been a Professor in the Electrical Engineering department at Okayama University. His research interests are active power filters, ac motor drives, and high frequency inverters.

Dr. Akagi has received four IEEE prize paper awards including the first prize paper award in IEEE transactions on Industry Applications for 1991.