

Tyre pressure monitoring using a dynamical model-based estimator

Giulio Reina^{a*}, Angelo Gentile^b and Arcangelo Messina^a

^a*Dipartimento di Ingegneria dell'Innovazione, Università del Salento, Via Arnesano, 73100 Lecce, Italy;* ^b*Dipartimento di Meccanica, Matematica e Management, Politecnico di Bari, Viale Japigia 128, 70125 Bari, Italy*

(Received 31 October 2014; accepted 10 January 2015)

In the last few years, various control systems have been investigated in the automotive field with the aim of increasing the level of safety and stability, avoid roll-over, and customise handling characteristics. One critical issue connected with their integration is the lack of state and parameter information. As an example, vehicle handling depends to a large extent on tyre inflation pressure. When inflation pressure drops, handling and comfort performance generally deteriorate. In addition, it results in an increase in fuel consumption and in a decrease in lifetime. Therefore, it is important to keep tyres within the normal inflation pressure range. This paper introduces a model-based approach to estimate online tyre inflation pressure. First, basic vertical dynamic modelling of the vehicle is discussed. Then, a parameter estimation framework for dynamic analysis is presented. Several important vehicle parameters including tyre inflation pressure can be estimated using the estimated states. This method aims to work during normal driving using information from standard sensors only. On the one hand, the driver is informed about the inflation pressure and he is warned for sudden changes. On the other hand, accurate estimation of the vehicle states is available as possible input to onboard control systems.

Keywords: tyre pressure monitoring; model-based estimator; vehicle vertical dynamics

1. Introduction

Although new steering and braking actuator designs provide opportunities to shape vehicle dynamics through active control, the primary challenge in the development of vehicle control systems remains the lack of necessary feedback. In this respect, the concept of virtual sensor has given rise to new interest in the automotive field. The basic idea is that of inferring a physical quantity that is not directly measured from existing sensors. Virtual sensing avoids expensive sensors or to compute 'abstract' quantities where feasible sensors do not exist. One notable example is tyre inflation pressure, whose importance for riding comfort and handling is well known. As a matter of fact, proper tyre inflation pressure improves handling, comfort, fuel economy and tyre life, and reduces braking distance. Nevertheless, approximately 75% of all automobiles operate with at least one underinflated tyre.[1] In a 2012 report, the National Highway Transport Safety Authority (NHTSA) of the USA states that tyre-related

*Corresponding author. Email: giulio.reina@unisalento.it

issues contribute to nearly 200,000 accidents per year.[2] Therefore, the availability of a tyre pressure monitoring system (TPMS) may avoid severe accidents and lead to both economical and environmental benefits. In 2000, NHTSA did start to investigate the implementation of a pressure drop warning system on vehicles. As a consequence since 2008, all new passenger cars and trucks in the USA are required to have tyre pressure monitoring systems.[3] A TPMS is a driver-assist system that warns the driver when the tyre pressure is below or above the prescribed limits. There are two ways of monitoring the tyre pressure.[4] One way is to mount a pressure sensor on the rim on each tyre and transfer the sensor value to a central unit via a communication-link (usually a radio-link). This is called direct tyre pressure monitoring and it is adopted in the majority of the systems available today on the market for its better accuracy. However, there are also some disadvantages connected with direct sensing. One issue is the increased cost of the system not only for the extra hardware required (that generally consists of pressure sensor, analog-digital converter, microcontroller, radio frequency, battery and battery management system, housing, etc.), but also for the car makers' cost of assembling the sensor inside the tyre. Besides the cost, direct TPMSs are powered by batteries that limit their useful life and impose the use of a number of low-power techniques engineered to help extend their life beyond 10-year requirements (e.g. by programming the system to not transmit information when the car is stationary). Another issue is that direct TPMS monitors are generally integrated with the valve stem. Thus, any damage to the fragile valve stem (even during normal workshop maintenance) can easily make the whole assembly unusable. The other alternative, called indirect tyre pressure monitoring, uses existing sensors (different from direct pressure sensors) and software algorithms. Indirect systems represent a promising solution in terms of cost-effectiveness (no extra hardware), and most of the current research focuses on their development, as reflected by more than 100 existing patents. However, indirect methods are generally regarded as less accurate and reliable than direct monitors, thus making their practical application still limited, as explained later.

This paper presents an indirect approach to estimate tyre inflation pressure during normal driving. A model-based estimator is presented, which is designed to work with errors in variables and simultaneously slow and fast parameter drifts. Virtual sensing explores correlations between different variables using physical relations. In the context outlined in this research, a vertical vehicle dynamic model is used to build a Kalman filter and infer estimation of tyre stiffness through a recursive least-square approach. It is known that variation of rolling dynamic stiffness with inflation pressure can be reasonably assumed linear, as explained for example in Section 1.6 of Wong.[5] Typically, a reduction of 25% in the inflation pressure of radial tyres results in a corresponding drop of 35–40% of tyre stiffness. Studies also show that the dynamic stiffness decreases sharply as soon as the tyre starts rolling. However, beyond a speed of approximately 10 km/h, the influence of velocity becomes less important.[6] Therefore, an indirect measurement of inflation pressure can be drawn by tyre stiffness estimation, as explained throughout the paper.

The manuscript is organised as follows. Section 2 surveys related research pointing out the novel contributions of the proposed approach. In Section 3, basic concepts of vertical vehicle dynamics are recalled that serve as a basis for the model-based observer developed in Section 4. However, state estimation may lead to poor results when model parameters are subject to temporal change or are not known a priori, as outlined in Section 4.1, for the specific case of tyre stiffness variation. To fix this issue, in Section 5 a parameter estimation scheme is proposed that recursively updates tyre stiffness providing flexibility to the observer. In turn, the availability of a tracking system of the tyre properties may be of great value for the development of warning and safety systems. The technique is studied in a sequence of simulations, as detailed in Section 6, attesting to the feasibility of the proposed approach. Relevant conclusions are drawn in the final Section 6.

2. Related works

Tyre parameter estimation is required to reduce the cost of direct TPMSs and to overcome the shortcomings of indirect TPMSs. Sensor industries are interested in producing cost-effective solutions. Although promising theoretical and practical results have been obtained from indirect TPMSs, only a few examples have been turned into commercial products.[7] There are various methods proposed for indirect TPMS. One solution is vibration analysis using the fact that the rubber in the tyre reacts like a spring when excited by road unevenness. The wheel vibration can be measured either by the tyre speed or through an accelerometer. The vibration analysis can be performed by fast Fourier transform-based methods or by parametric methods (using an auto-regressive model).[8] The idea is to monitor the resonant frequency, which is correlated with tyre pressure.[9,10] In [11], online model-based observers and data-based signal processing using power spectral methodologies are proposed to identify changes in vehicle tyre/suspension parameters (including inflation pressure) by using an accelerometer mounted on the wheel hub in conjunction with a wheel rotation speed sensor. However, there may be insufficient excitation on smooth roads to yield good data using vibration-based analysis. Additionally, there is still significant imprecision with these approaches and potentially anomalous readings may yield insufficient information to form a conclusion. Another solution is based on wheel radius analysis using the fact that the effective rolling radius of the wheel decreases if tyre loses pressure. Tyre pressure difference results in a measurable differential speed of the wheels and is analysed accordingly. By comparing the angular velocity of the wheels, it is possible to detect if one wheel is faster than the others due to underinflation.[12] A pressure drop of approximately 30% typically produces an increase in wheel rotational speed of 0.2–0.5%. The system is able to detect pressure losses of more than 30% relative to normal pressure with a detection time of about 3 min, and about 1 min for a 50% pressure drop. Thus, this approach generally suffers from possible slow warning times and may be ineffective for small pressure losses (less than 30%). It should be emphasised that it is more a convenience system than a proper safety system. As an additional inherent disadvantage, this approach cannot detect equal pressure losses on the same axes or side of the vehicle. The system also needs to be calibrated frequently, which could be difficult for end users.

Vibration-based and wheel velocity-based methods show different properties in terms of sensitivity to varying velocity and ability to detect pressure changes. Typically, wheel radius analysis is more sensitive to velocity, but on the other hand it responds faster to pressure changes. In contrast, vibration analysis is more sensitive to varying road conditions, but is insensitive to travel speed. As an alternative to vibration and wheel radius analysis, it is possible to consider other factors that affect tyre inflation pressure, including vertical force and vertical deflection.[13] Hybrid solutions (i.e. combining direct and indirect methods) have also been studied. As an example, in [14], a method to estimate tyre load is proposed using a Kalman filter that receives as inputs the chassis vertical acceleration and the wheel hub vertical acceleration, whereas tyre stiffness is measured from an existing pressure sensor mounted inside the tyre. Another solution is to adopt virtual sensing to infer a desired variable from available sensory data. For this aim, model-based estimators have been proposed using either longitudinal or lateral vehicle dynamics. As suggested in [15], under-inflation can be estimated by comparing the driven and non-driven wheels, using a tyre/road friction model.[16] In the same paper, lateral dynamics is also used for pressure detection in conjunction with a rate gyroscope.

Using state observers, key vehicle parameters can be estimated, including tyre cornering stiffness,[17] vehicle slip angle,[18] understeer gradient, yaw moment of inertia, roll stiffness, and roll damping coefficient.[19] Least-squares and total least-squares methods have also been used to measure cornering stiffness and weight distribution.[20]

In this work, tyre inflation pressure is estimated through an identification technique, which relies on tyre stiffness variation with respect to inflation pressure. An adaptive observer is presented based on the vertical dynamic model of the vehicle, which represents a novel contribution to the literature. The use of a recursive least-squares (RLS) module that runs in parallel to the observer to update tyre stiffness (and indirectly inflation pressure) is also a novel contribution. In addition, by simple modification (i.e. by adding a forgetting factor), the basic RLS algorithm can be modified in order to track time-varying dynamics.

3. Vehicle model

The vertical motion of a vehicle, caused by road irregularities and controlled by suspension characteristics, is important in vehicle design, as it directly affects comfort and handling properties. The study of vehicle dynamics should ideally consider the pitch and roll motions of the vehicle as well as the vertical (heave) motion. However, it can be shown that the coupling between the pitch and roll and heave motions is not significant for typical passenger vehicles,[21] and a so-called ‘quarter-car’ model can be considered, as illustrated in Figure 1. A two degree-of-freedom (2DOF) quarter-car (QC) model considers both the vehicle sprung mass, m_b , as well as the unsprung mass, m_w , associated with the tyre–axle assembly. Their motion in the vertical direction can be described by two coordinates, z_b and z_w , with origins at the static equilibrium positions of the sprung and unsprung mass, respectively. A passive suspension is assumed, where k_s is the stiffness of the suspension spring, and c_s is the damping coefficient of the shock absorber. The vertical tyre stiffness is k_w , whereas the tyre damping

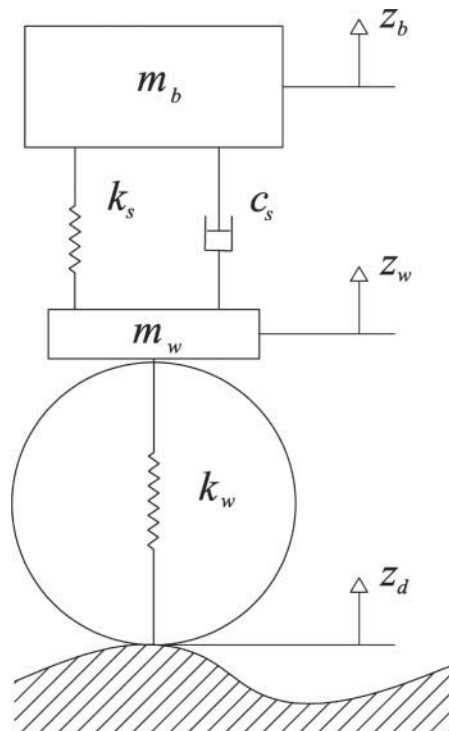

Figure 1. Quarter-car model.

can typically be neglected. The equations of motion for the QC model are given by

$$m_b \ddot{z}_b = -k_s(z_b - z_w) - c_s(\dot{z}_b - \dot{z}_w), \tag{1}$$

$$m_w \ddot{z}_w = k_s(z_b - z_w) + c_s(\dot{z}_b - \dot{z}_w) - k_w(z_w - z_d), \tag{2}$$

where z_d is the elevation of the road profile. By choosing the following variables as the states of the system:

$$\begin{aligned} x_1 &= z_b - z_w, \\ x_2 &= \dot{z}_b, \\ x_3 &= z_w - z_d, \\ x_4 &= \dot{z}_w, \end{aligned} \tag{3}$$

it is possible to derive the equations of motion in standard state-variable form:

$$\frac{d}{dt} \begin{bmatrix} x_1 \\ x_2 \\ x_3 \\ x_4 \end{bmatrix} = \begin{bmatrix} 0 & 1 & 0 & -1 \\ -\frac{k_s}{m_b} & -\frac{c_s}{m_b} & 0 & \frac{c_s}{m_b} \\ 0 & 0 & 0 & 1 \\ \frac{k_s}{m_w} & \frac{c_s}{m_w} & -\frac{k_w}{m_w} & -\frac{c_s}{m_w} \end{bmatrix} \begin{bmatrix} x_1 \\ x_2 \\ x_3 \\ x_4 \end{bmatrix} + \begin{bmatrix} 0 \\ 0 \\ -1 \\ 0 \end{bmatrix} \dot{z}_d, \tag{4}$$

where \dot{z}_d represents the vertical velocity of the tyre at the ground contact point, that is, the disturbance input coming from the road, and hence $u = \dot{z}_d$. In a compact matrix form, the equations of motion can be written as

$$\dot{x} = A(t)x + Bu(t), \tag{5}$$

where the state and disturbance input matrices are

$$A(t) = \begin{bmatrix} 0 & 1 & 0 & -1 \\ -\frac{k_s}{m_b} & -\frac{c_s}{m_b} & 0 & \frac{c_s}{m_b} \\ 0 & 0 & 0 & 1 \\ \frac{k_s}{m_w} & \frac{c_s}{m_w} & -\frac{k_w}{m_w} & -\frac{c_s}{m_w} \end{bmatrix}, \quad B = \begin{bmatrix} 0 \\ 0 \\ -1 \\ 0 \end{bmatrix}. \tag{6}$$

Note that time variability is allowed in the parameter $k_w(t)$, that is, tyre stiffness, that can be directly related with changes in the inflation pressure. The method proposed in this paper for indirect tyre pressure monitoring is based on the use of two accelerometers measuring the acceleration of the sprung and unsprung mass, respectively. Assuming that sprung mass acceleration can be obtained via the ESP system of the car, this configuration may result in a significant cost reduction (e.g. half of the cost of direct methods considering that the current prize of most OEM pressure sensors is of \$90–140).

The measurement system can be described by the following differential equations:

$$\begin{aligned}\ddot{z}_b &= -\frac{k_s}{m_b}(z_b - z_w) - \frac{c_s}{m_b}(\dot{z}_b - \dot{z}_w), \\ \ddot{z}_w &= \frac{k_s}{m_w}(z_b - z_w) + \frac{c_s}{m_w}(\dot{z}_b - \dot{z}_w) - \frac{k_w}{m_w}(z_w - z_d).\end{aligned}\tag{7}$$

If the measurement vector z is introduced

$$z = \begin{bmatrix} \ddot{z}_b \\ \ddot{z}_w \end{bmatrix}\tag{8}$$

by considering the state vector expressed by Equations (3), Equation (7) can be written in the following compact form:

$$z(t) = H(t)x,\tag{9}$$

where the measurement matrix is given by

$$H(t) = \begin{bmatrix} -\frac{k_s}{m_b} & -\frac{c_s}{m_b} & 0 & \frac{c_s}{m_b} \\ \frac{k_s}{m_w} & \frac{c_s}{m_w} & -\frac{k_w}{m_w} & -\frac{c_s}{m_w} \end{bmatrix}.\tag{10}$$

In summary, Equations (5) and (9) can serve as the basis for linear estimation methods. In the context of this research, Kalman filtering will be adopted, as explained later in the paper.

4. Vehicle estimation

In many mechanical systems, it is often difficult to measure all states describing the system's dynamic behaviour. In addition, some of the model parameters may not be known a priori or they are subject to temporal changes. In principle, it may be useful to save resources if state/parameter estimation may be obtained by derivation using other available sensor data. For example, in the last few years new safety control systems have been increasingly introduced in the automotive field based on the use of a massive use of electronics. However, a significant cost reduction may be obtained by appropriately designing a minimum set of physical sensors that ensure the correct control action keeping, at the same time, good performance and robustness. On the other hand, in most feedback control systems, the control action depends on some important variables (lateral vehicle velocity, sideslip angle, tyre-road forces, etc.), which are often not directly measurable because of technical and/or economic reasons. Therefore, the use of so-called observers, estimators, filters or virtual sensors can be of great value. Estimation or observation means the extraction of information of a given variable of interest that is not directly measurable by using only available sensor data. The idea is to implement a model of the real system in an onboard computer that runs in parallel with the system itself providing estimation of a given set of states or variables of interest. The state-space approach in the discrete-time formulation is adopted for modelling. For dynamic state estimation, the discrete-time approach is both widespread and convenient for real-time application using onboard systems.

One important aspect of state estimation is that the system to be observed is usually excited by a stochastic noise w , due for example to imperfections in modelling the system. Therefore, dynamic systems are not driven only by 'pure' control inputs, but unknown and uncontrolled

disturbances can affect the system behaviour. In addition, sensor readings may be biased and affected by their own stochastic noise v . Therefore, deterministic open-loop models may be of limited validity and stochastic closed-loop observers are necessary. One common approach is the Kalman filter that is a well-known technique for state and parameter estimation. It is a recursive estimation procedure that uses sequential sets of measurements. The Kalman filter addresses the general problem of estimating the state of a discrete-time controlled process that is governed by a linear difference equation (i.e. Equation (5)) with a measurement (i.e. Equation (9)). In order to implement a state observer using Kalman filtering, the linear system, expressed by Equations (5) and (9), needs to be expressed in a stochastic discrete-time state-space representation

$$x_{k+1} = A_d x_k + B_d u_k + w_k, \quad (11)$$

$$z_{k+1} = H_d x_{k+1} + v_{k+1}, \quad (12)$$

where A_d , B_d , H_d are the discretised state matrix, input vector matrix, and measurement matrix, respectively, $x_k = [x_{1,k}, \dots, x_{4,k}]^T$ is the state vector at time k , u_k is the input vector at time k , and z_k is the observation sampled at time k .

The process disturbance and the measurement noise, w_k and v_k , respectively, are assumed to be Gaussian, temporally independent of each other, and white, Q and R being the process and measurement noise covariance, respectively. Kalman filtering estimation operates through the prediction–correction cycle expressed by

Prediction:

$$\hat{x}_{k+1}^- = A_d \hat{x}_k + B_d u_k, \quad (13)$$

$$P_{k+1}^- = A_d P_k A_d^T + Q. \quad (14)$$

Correction:

$$K_{k+1} = P_{k+1}^- H_d^T (H_d P_{k+1}^- H_d^T + R)^{-1}, \quad (15)$$

$$\hat{x}_{k+1} = \hat{x}_{k+1}^- + K_{k+1} (z_{k+1} - H_d \hat{x}_{k+1}^-), \quad (16)$$

$$P_{k+1} = (I - K_{k+1} H_d) P_{k+1}^-, \quad (17)$$

where \hat{x}_{k+1}^- is the predicted state vector, P_{k+1}^- is the variance matrix for \hat{x}_{k+1}^- , K_{k+1} is the gain matrix, \hat{x}_{k+1} is the updated state vector, and P_{k+1} is the updated error covariance estimate. The prediction equations are responsible for projecting forward in time the current state and error covariance estimates to obtain the a priori estimates for the next time step. The correction equations are responsible for the feedback, that is, for incorporating a new measurement into the a priori estimate to obtain an improved a posteriori estimate.

To sum up, the states being estimated by the proposed observer are the suspension stroke (x_1), velocity of the vehicle body (x_2), wheel deflection (x_3), and vertical velocity of the wheel mount (x_4). The measurement noise covariance is used to define the error of the sensor measurements, that is, the accelerations of the sprung and unsprung mass. Table 1 collects the sensor noise used in this paper that can be generally found on the sensor specification sheet

Table 1. Sensor technical details.

	Accelerometer
Sensor noise (1σ)	0.05 m/s ²
Output rate	100 Hz

Table 2. Parameters of the quarter-car model used in the simulations, please refer to Figure 1 for more details.

m_b	454.5 kg
m_w	45.45 kg
k_s	27,625 N/m
c_s	2,126 Ns/m
k_w	221,000 N/m

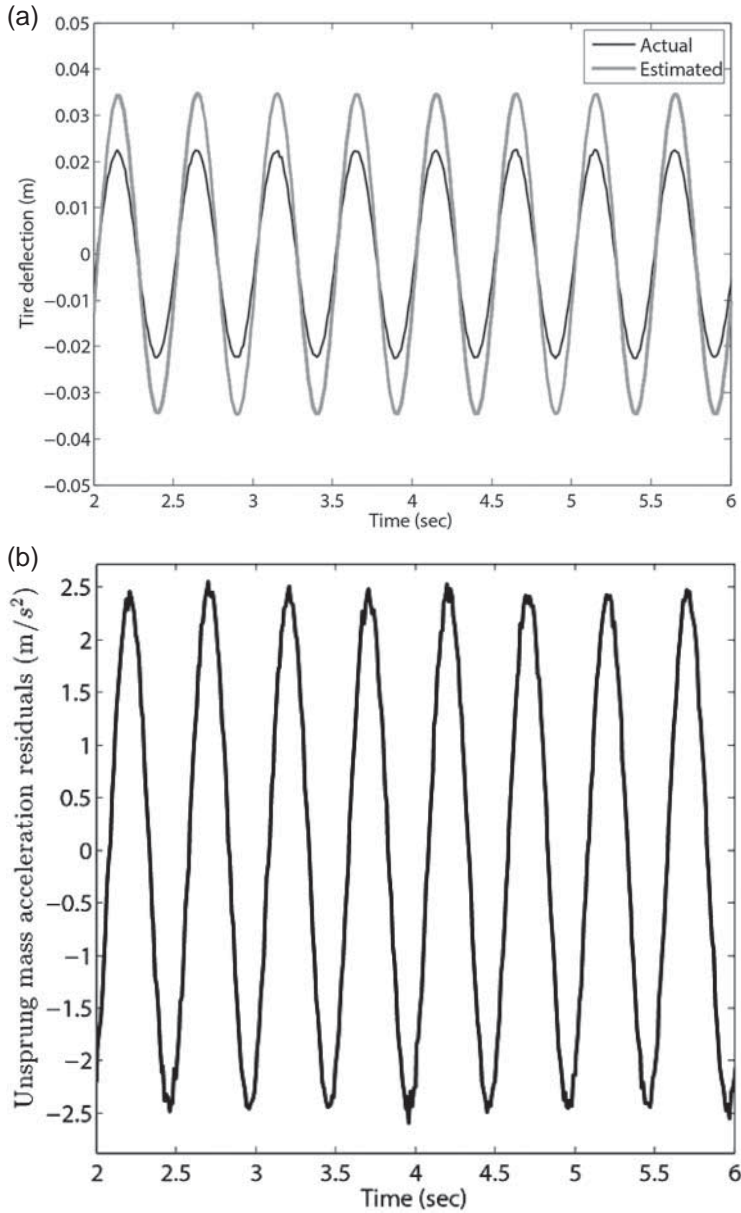

Figure 2. (a) State estimation using incorrect parameters in the estimator (i.e. $k_w = 136,000$ N/m). (b) Residuals obtained from an estimator with incorrect model parameters.

or from analysing static data from the sensor. In conclusion, using sensor fusion techniques, virtual sensors can be derived that compute information that would be either too costly or difficult to measure in practise.

4.1. Parameter sensitivity

First, a simulation was performed to show the effects of incorrect model parameters (i.e. tyre stiffness) on the observer. The simulation used the parameters of a typical passenger car (see Table 2) driving with constant travel speed of 10 m/s on a sinusoidal road profile of 5 m

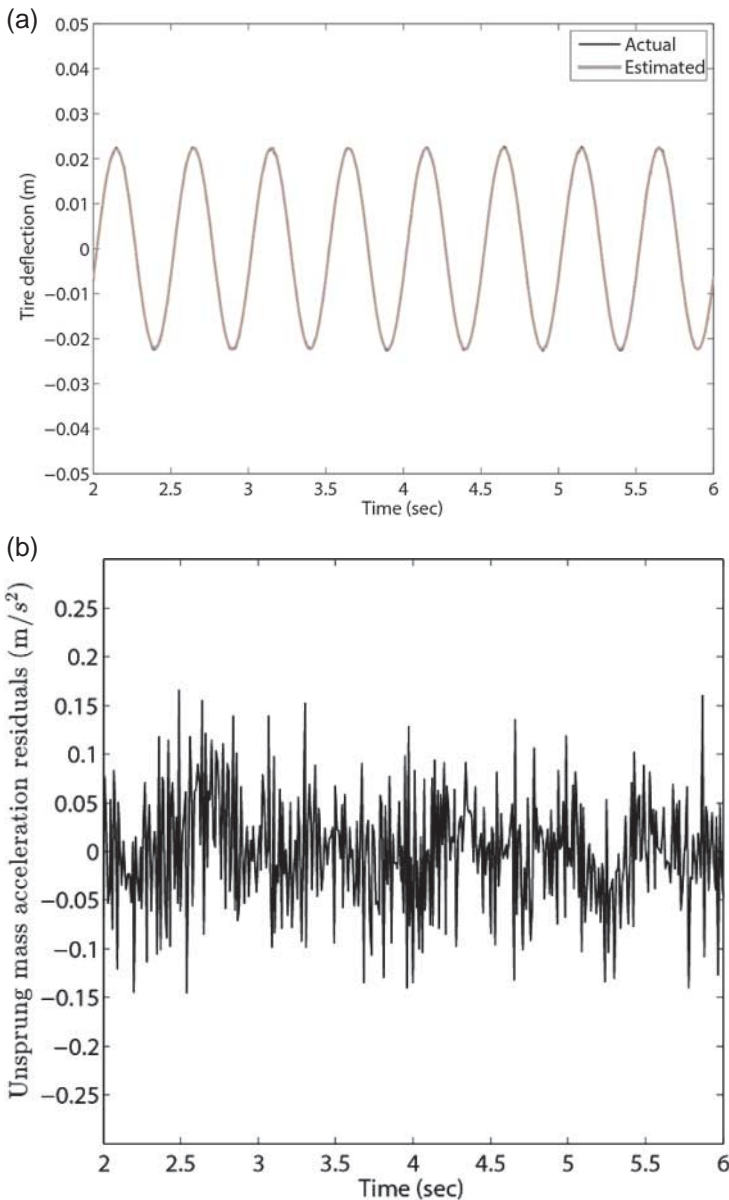

Figure 3. (a) State estimation using correct parameters in the estimator (i.e. $k_w = 221,000$ N/m). (b) Residuals obtained from an estimator with correct model parameters.

wave length and 0.1 m amplitude (i.e. with an excitation frequency of 2 Hz). The vertical behaviour of the vehicle was simulated by discretising Equations (5) and (9) with process and sensor noise. The acceleration measurements of the sprung and unsprung mass were corrupted with random noise of the standard deviation as claimed in the specification of the accelerometers (see Table 1). Additionally, a 2% scale factor error, which is within the normal sensor's specifications, was added to both accelerations. The measurements were corrupted in order to provide realistic sensory input to the model-based observer. First, the estimator was given the parameters of a different vehicle (i.e. an incorrect tyre stiffness $k_w = 136,000$ N/m was assumed in the model with a reduction of about 40% of the nominal (actual) value $k_w = 221,000$ N/m), and the results are shown in Figure 2. For the reader's sake, only one of the four states obtained from the observer is reported, namely tyre deflection x_3 , which is the most affected by k_w . In detail, Figure 2(a) shows the simulated and estimated tyre deflection and reveals how model parameter error leads to biased estimations of the state. One way to check the model accuracy is to look at the residuals, that is, the difference between the actual and the estimated measurements. The residuals for a correct observer should be white noise with zero mean. Conversely, in Figure 2(b) residuals for the unsprung mass acceleration, as obtained from the observer with incorrect parameter, show a definite shape (or correlation). The simulation was repeated using the correct value of the tyre stiffness in the estimator. The results of the estimation of the tyre deflection are shown in Figure 3(a), demonstrating that with correct parameters the estimation is very accurate even in the presence of a scale factor error. This is also confirmed when looking at the residuals of the unsprung mass acceleration which appears approximately as a zero mean white noise (Figure 3(b)).

5. Vehicle parameter estimation

As demonstrated in the previous section, the design of vehicle control systems requires system models to be accurate enough to achieve the desired level of closed-loop performance. Parameters of the models are one of the important factors that determine the accuracy of system modelling and eventually the overall performance of closed-loop systems. This section investigates a parameter estimation scheme that recursively estimates tyre vertical stiffness using least squares. In order to track time-varying parameters, a forgetting factor is used. Although alternative algorithms for parameter estimation exist (e.g. extended Kalman filter by incorporating tyre stiffness in the state variable vector), we found RLS to be an appropriate solution to this problem. Estimation of tyre inflation pressure can be directly inferred from vertical stiffness through a linear relationship. Once vehicle parameters are precisely estimated, driver warning systems can be developed and the parameterised vehicle dynamics models with properly estimated parameters can be used for a wide variety of applications including highway automation, vehicle stability control, and rollover prevention systems.

5.1. Estimation of tyre stiffness using recursive least squares

Tyre stiffness is estimated assuming that mass and suspension properties are known or estimated. It is interesting to note that, with reference to Figure 1, the overall dynamics of the quarter model can be expressed as

$$-m_b \ddot{z}_b - m_w \ddot{z}_w = x_3 k_w. \quad (18)$$

In Equation (18), the first member can be measured by the onboard accelerometers, whereas the state x_3 can be estimated by the observer presented in the previous section. Therefore, k_w

can be obtained through RLS running in parallel with the observer. To this aim, Equation (18) can be rewritten as

$$y = \varphi^T \theta, \tag{19}$$

where

$$\begin{aligned} y &= [-m_b \ddot{z}_b - m_w \ddot{z}_w], \\ \varphi^T &= x_3, \\ \theta &= k_w. \end{aligned} \tag{20}$$

Since y is measured, there exists a measurement error, Δy , and the estimation problem can be reformulated as follows:

$$\begin{aligned} \arg \min_{\theta} \quad & \| \Delta y \| \\ \text{Subject to:} \quad & \hat{y} = \varphi^T \theta + \Delta y \end{aligned} \tag{21}$$

The minimisation problem can be solved by RLS that updates the parameter estimate through the recursion

$$\begin{aligned} \theta_t &= \theta_{t-1} + G_t (y_t - \varphi_t^T \theta_{t-1}), \\ G_t &= \frac{S_{t-1} \varphi_t}{\lambda + \varphi_t^T S_{t-1} \varphi_t}, \\ S_t &= \frac{S_{t-1} - G_t \varphi_t^T S_{t-1}}{\lambda} \end{aligned} \tag{22}$$

λ being the so-called forgetting factor. The smaller λ , the smaller the weight of previous samples. In practice, λ is usually chosen between 0.9 and 1. The use of λ allows the recursive identification algorithm to be modified to handle the (common) case when the system dynamics are varying over time. Figure 4 compares the block diagram of a conventional observer with fixed parameters (Figure 4(a)), with the proposed adaptive approach (Figure 4(b)). By

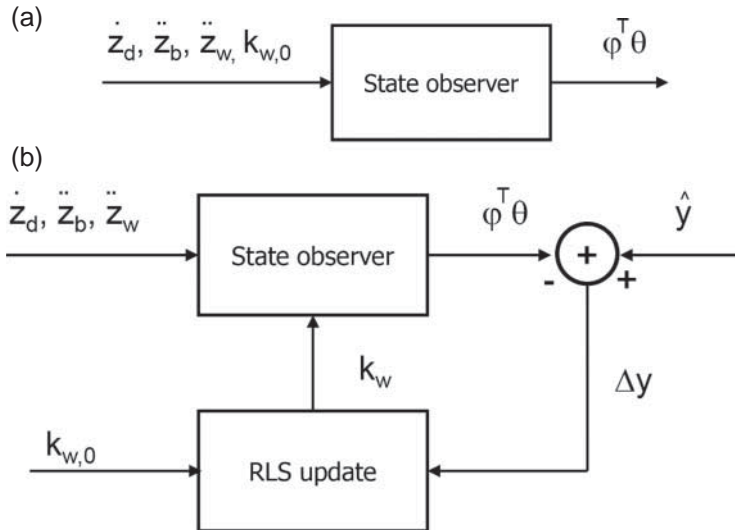

Figure 4. (a) Block diagram of a conventional fixed-parameter estimator. (b) Block diagram of the proposed adaptive estimator using a RLS module running in parallel.

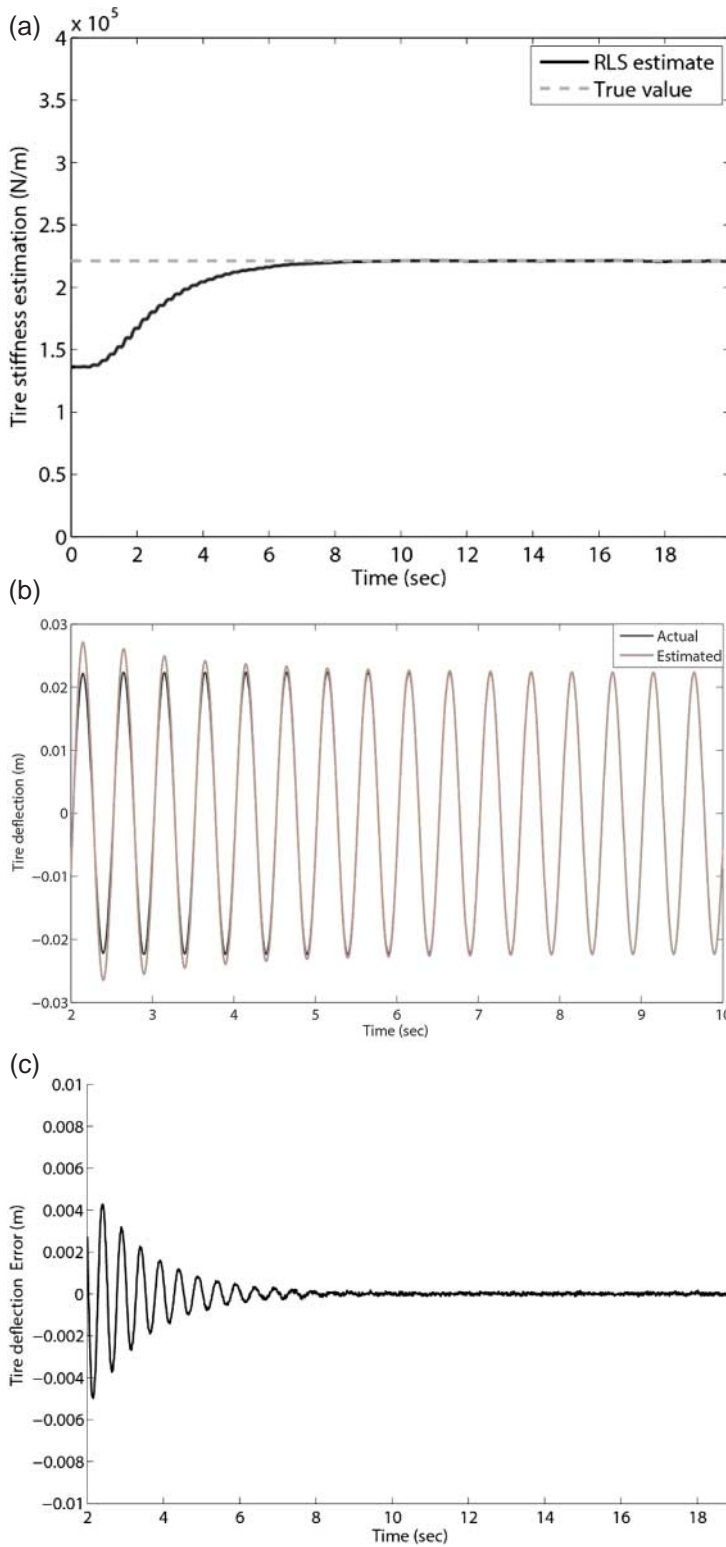

Figure 5. (a) RLS estimation of tyre stiffness, $v = 10.0$ m/s (i.e. 2 Hz excitation frequency), sinusoidal road profile (0.1 m amplitude and 5 wave length), $\lambda = 0.95$. (b) State estimation obtained from the observer using RLS parameter estimation. (c) State estimation error for x_3 , that is, tyre deflection.

running a RLS module in parallel with the observer, it is possible to get an updated estimate of the tyre stiffness at each new iteration of the system improving the overall observer performance.

The exponential convergence of RLS has been proved in some research papers.[22] However, one should note that this scheme may suffer from covariance ‘wind-up’ problems during poor excitation. The inverse covariance matrix of the parameter estimate is

$$S_t^{-1} = \sum_{k=1}^t \lambda^{t-k} \varphi_k \varphi_k^T. \tag{23}$$

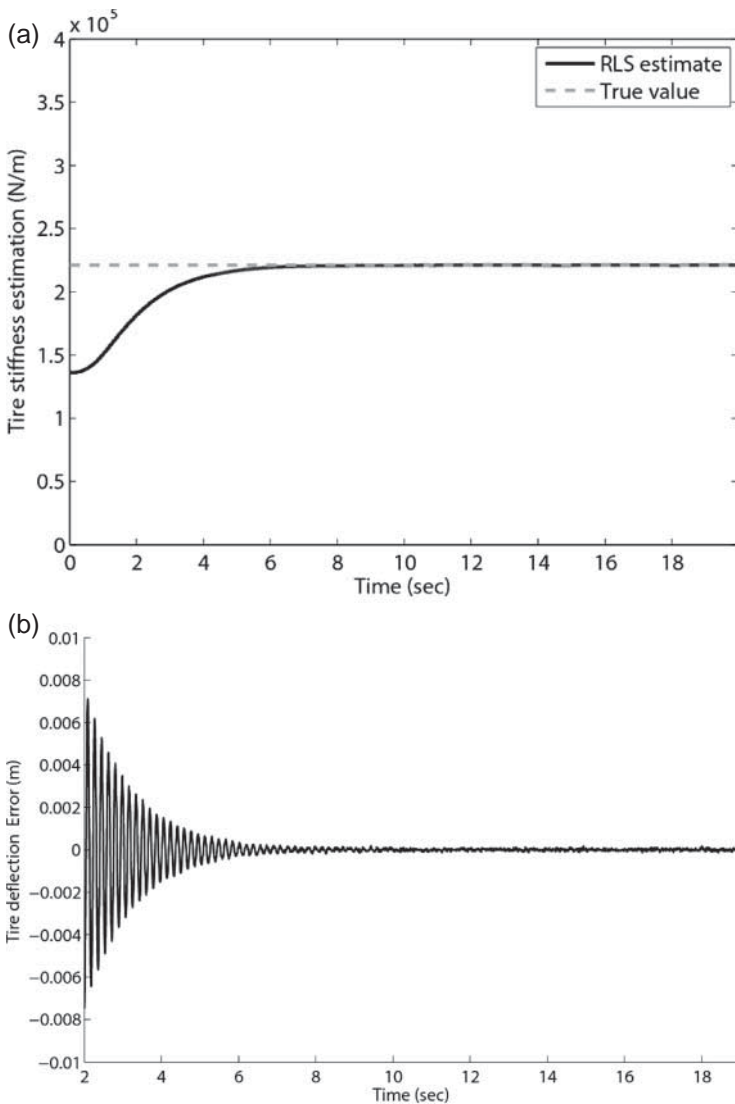

Figure 6. (a) RLS estimation of tyre stiffness, $v = 28.0$ m/s (i.e. 5.6 Hz excitation frequency), sinusoidal road profile (0.1 m amplitude and 5 wave length), $\lambda = 0.95$. (b) State estimation obtained from the observer using RLS parameter estimation. (c) State estimation error for x_3 , that is, tyre deflection.

Therefore, if tyre deflection is small, S_t^{-1} gets closer to singularity, the covariance matrix is large and the estimates very uncertain. In other words, old information is continuously discarded, whereas there is very little new dynamic information coming in. As a result, the estimator becomes extremely sensitive and subject to uncertainty.

Typical results obtained from the RLS approach applied to the running case, presented in Section 4.1, are shown in Figure 5. Initially, the observer is given an erroneous value of the tyre stiffness, that is, $k_w = 136,000$ N/m. In Figure 5(a), the recursive parameter estimation obtained from the system is shown by a solid black line. Using a forgetting factor of $\lambda = 0.95$, the RLS modules correct the parameter towards its actual value $k_w = 221,000$ N/m (denoted by a grey dotted line), after an approximately 9 s adaptation window. As the system adjusts

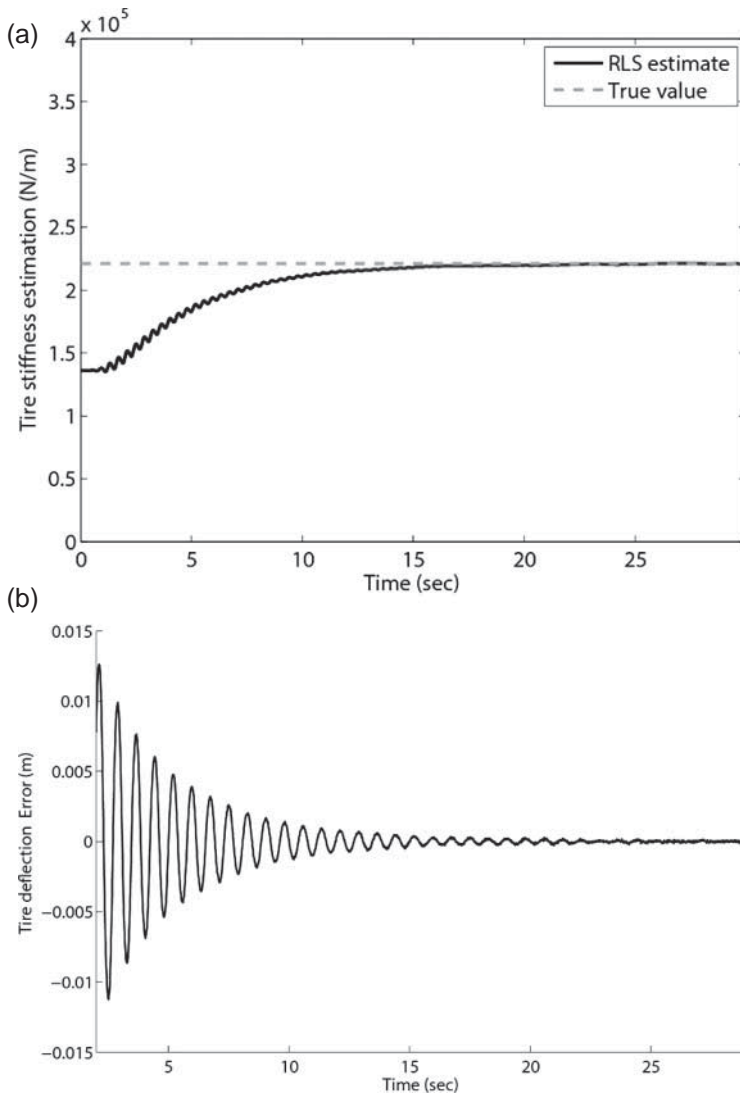

Figure 7. (a) RLS estimation of tyre stiffness, $v = 6.5$ m/s (i.e. 1.3 Hz excitation frequency), sinusoidal road profile (0.1 m amplitude and 5 wave length), $\lambda = 0.95$. (b) State estimation obtained from the observer using RLS parameter estimation. (c) State estimation error for x_3 , that is, tyre deflection.

tyres stiffness, the output from the observer becomes more accurate and the discrepancy of the state estimate with the actual value decreases, as shown in Figure 5(b) and 5(c).

The simulation was repeated by varying the vehicle’s travel speed (i.e. varying the input excitation frequency) for the same sinusoidal road profile (0.1 m amplitude and 5 wave length) and forgetting factor ($\lambda = 0.95$). In detail, in Figure 6 the results obtained from the system using a travel speed of 28 m/s (5.6 Hz excitation frequency) are shown. The RLS module responds faster reaching the true tyre stiffness value in about 8 s. Conversely, if the travel speed decreases to 6.5 m/s (i.e. 1.3 Hz excitation frequency), the parameter is correctly estimated in about 25 s, as shown in Figure 7.

6. Results

One of the problems in simulating car vertical dynamics is that the road input is not known a priori. However, most of the driving is performed on horizontal roads where the power spectral density of the input road-velocity profile \dot{z}_d can be reasonably assumed constant.[23] Therefore, road excitation can be considered equivalent to a purely random variable (i.e. white-noise). Excitation variance is typically assumed as $\sigma_d = 2\pi \cdot G_r \cdot V$, where G_r is the road roughness coefficient and V is the vehicle forward velocity. The International Standard Organization (ISO) defines a road classification scheme based on the value of G_r ,[24] as shown in Table 3. For average road class (ISO class C), the road roughness coefficient value can be chosen as $64 \times 10^{-7} \text{ m}^2\text{cycle/m}$ for a travel speed of 25 m/s.[25] In this simulation, an abrupt drop in tyre stiffness (pressure) was reproduced during motion at time $t = 200$ s, that is, $k_w(t) = 221,000 \text{ N/m}$ for $t < 200$ s and $k_w(t) = 136,000 \text{ N/m}$ for $t \geq 200$ s. This corresponds to a step change from normal to low pressure. A realisation of the input and output of the system in terms of tyre stiffness estimation is shown in Figure 8(a) using two forgetting factors, namely $\lambda = 0.95$ and $\lambda = 0.99$. In both cases, the system estimates correctly the tyre stiffness flagging the step change. As seen from the figure, a low forgetting factor gives a fast tracking (Figure 8(b)) but a noisier estimate compared with when a forgetting factor closed to one is used (Figure 8(c)). Thus, the basic trade-off between fast tracking and noise sensitivity is confirmed.

6.1. System performance

In order to evaluate the performance of the proposed method in different operating conditions, simulation tests are presented by varying road type, travel velocity and pressure drop. In all tests, the system was tuned with a forgetting factor $\lambda = 0.98$. The first set of simulations is shown in Figure 9. In this set, a pressure drop of 25% with respect to the nominal value is considered, which is the warning activation threshold set by the US legislation. Each row of Figure 9 shows from left to right the recursive estimation of tyre stiffness for increasing road roughness according to the ISO 8608 (from road class A-very good to class D-poor) and equal travel speed. Conversely, each column of the same figure shows from top down

Table 3. Road-roughness coefficients G_r ($\text{m}^2 \cdot \text{cycle/m}$).

Road class	A Very good	B Good	C Average	D Poor	E Very poor	F	G
$G_r, \times 10^{-7}$	4	16	64	256	1024	4096	16,384

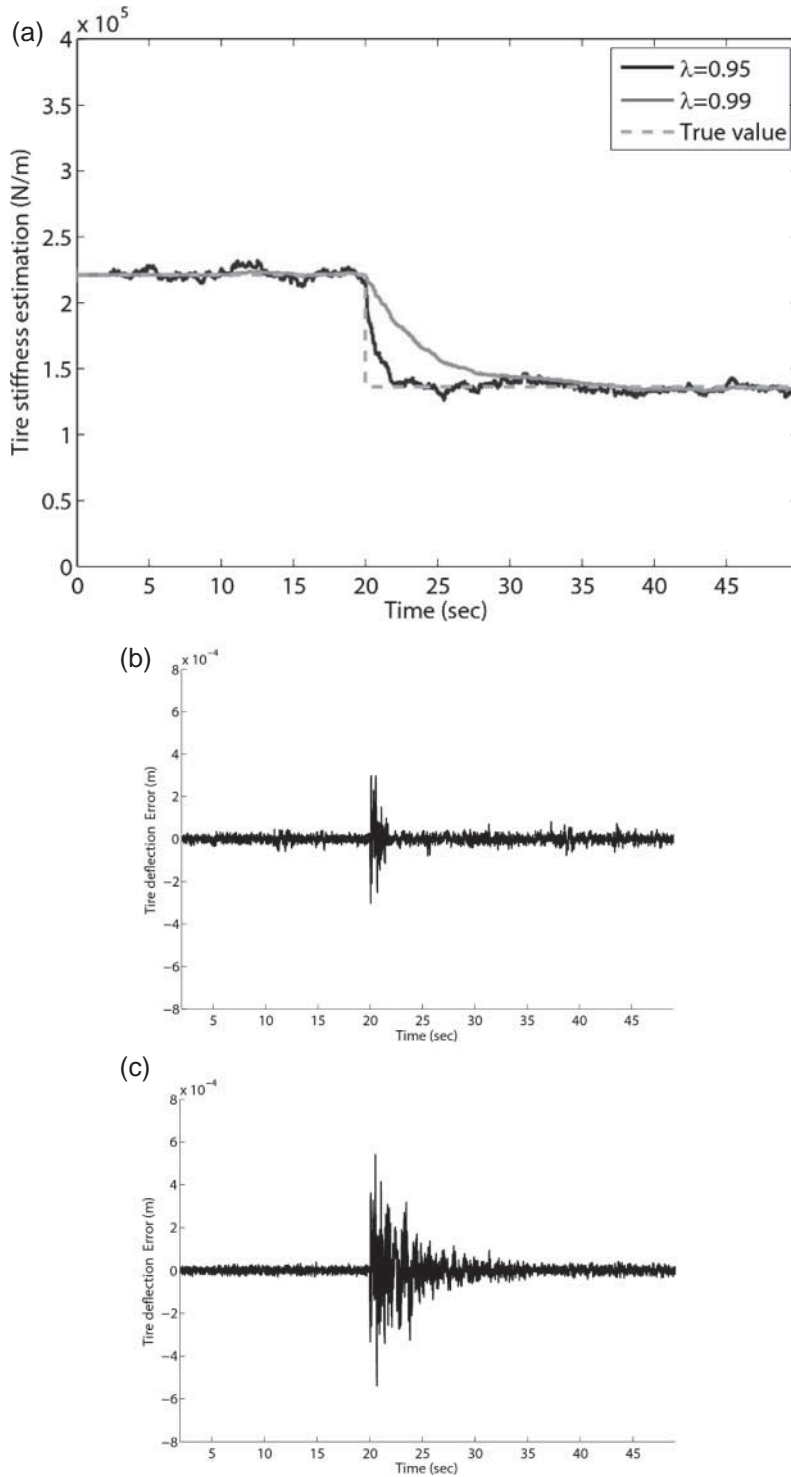

Figure 8. (a) Illustration of RLS estimation of tyre pressure with forgetting factor. True parameter (dotted grey line), RLS estimate with forgetting factor 0.95 (solid black line), and with forgetting factor 0.99 (solid grey line). (b) Error in tyre deflection estimation using $\lambda = 0.95$. (c) Error in tyre deflection estimation using $\lambda = 0.99$.

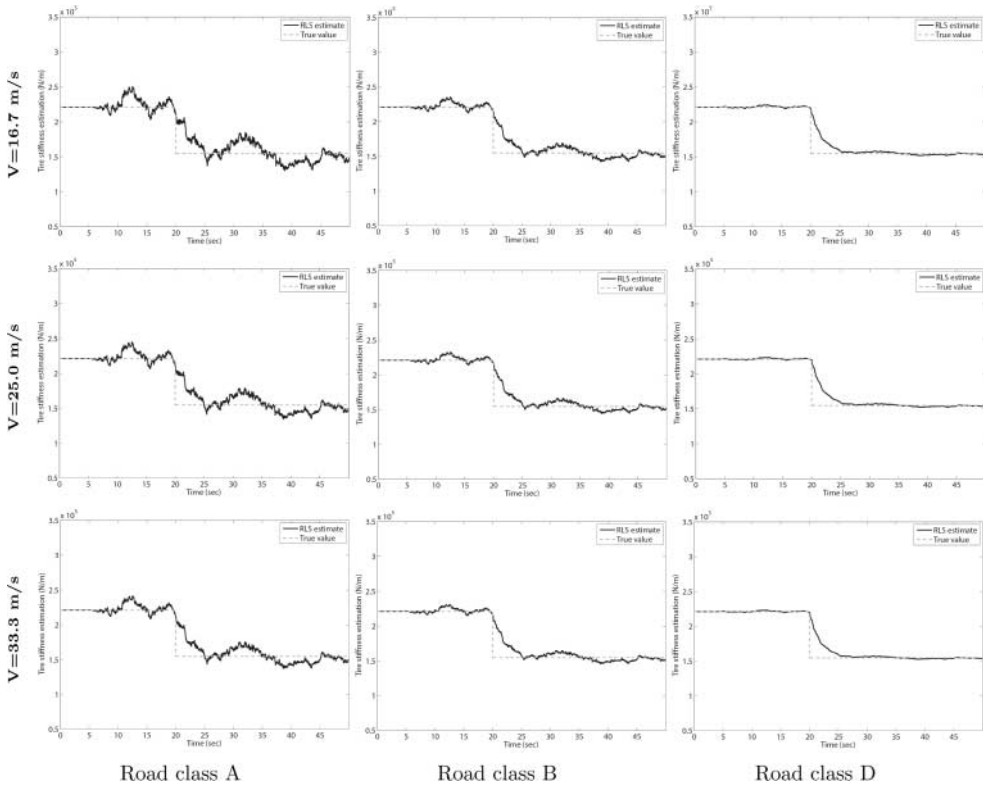

Figure 9. Tyre stiffness estimation (25% drop) for varying travel speed and road type: (a) Road class A. (b) Road class B. (c) Road class D.

the response of the system for increasing travel speed (from 16.7 to 33.3 m/s) and equal road type. In all cases, the system correctly estimates tyre stiffness within few seconds (about 5 s), independent of speed and road roughness. Estimation accuracy improves with road roughness and travel speed. However, the influence of velocity is of lesser importance. Worst-case scenario results for very good road type and slow vehicle, due to low excitation.

Another important aspect is the system sensitivity, that is, the minimum detectable change in inflation pressure. This is particularly true in view of the adoption of TPMSs by the European Union (expected in 2015) that will target a warning activation threshold of 15% of pressure drop due to higher speed limits (e.g. German autobahns). A second set of simulations is collected in Figure 10, where a sudden change from normal to low pressure (15%

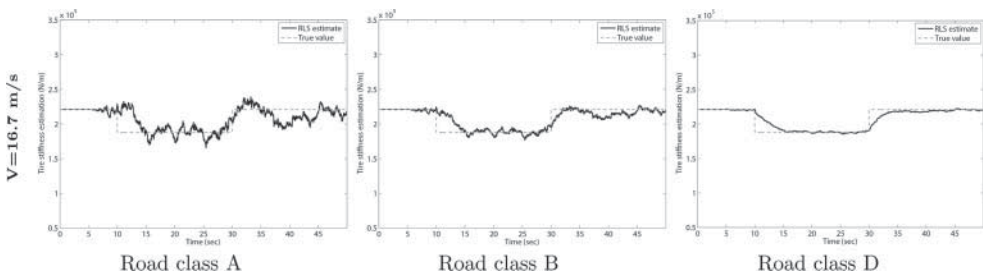

Figure 10. Tyre stiffness estimation (15% drop) for varying road type and travel speed of 16.7 m/s: (a) Road class A. (b) Road class B. (c) Road class D.

drop), and then back to normal pressure is assumed. A relatively slow travel speed of 16.7 m/s is set, whereas road type is varied from very good to poor. The system again provides good estimate of tyre stiffness. The rougher the road, the higher the accuracy.

These figures show that the proposed method is effective in estimating changes in tyre properties overcoming the possible disadvantages of indirect TPMS in terms of time response and sensitivity. The system seems to respond well even in the case of low excitation. One additional advantage is that the system does not require any learning or reset procedure that can be time consuming and difficult to perform.

7. Conclusions

A model-based estimator for estimating tyre vertical stiffness (and indirectly tyre inflation pressure) during normal driving and using only standard sensors was presented. The algorithm is based on a Kalman filter supported by recursive least square to give robust and accurate estimates of tyre stiffness and, at the same time, to allow abrupt changes to be tracked quickly. Results obtained from simulation tests were presented to validate the proposed approach, using different disturbance inputs (i.e. sinusoidal road profile and road roughness) and varying operating conditions (i.e. varying travel speed and pressure drop). The sensitivity of the system to the forgetting factor in the RLS module was also studied. Especially, variations in tyre stiffness can be detected quite accurately. The proposed approach could be useful to implement warning and safety systems and for accurate estimation of the vehicle states as a possible input to onboard control systems.

A possible limitation of this approach is that it may perform poorly under low excitation conditions. Before implementation, the self-calibration issue should be carefully investigated and the system evaluated in field tests on a long-term basis.

References

- [1] Wingert L. Not to Air Is human. Crane Communications; 2000.
- [2] Schrader Bridgeport Standard Thomson, TPMS & Consumer Awareness. Available from: http://www.tpmsmadesimple.com/consumer_awareness.php
- [3] NTSH, Federal motor vehicle safety standards. Available from: <http://icsw.nhtsa.gov/cars/rules/> PDF file; 2014.
- [4] Velupillai S, Guvenc L. Tire pressure monitoring. *IEEE Control Syst Mag.* 2007;7:22–25.
- [5] Wong J. Theory of ground vehicles. Hoboken (NJ): John Wiley & Sons; 2008.
- [6] Lines J, Murphy K. The stiffness of agricultural tractor tyres. *J Terramechanics.* 1991;28(1):49–64.
- [7] NIRA Dynamics, TPI – the most advanced indirect tire pressure monitoring system. Available from: http://www.niradynamics.se/products/tire_pressure_indicator+
- [8] Umeno T, Asano K, Ohashi H, Yonetani M, Naitou T, Taguchi T. Observer based estimation of parameter variations and its application to tyre pressure diagnosis. *Control Eng Pract.* 2001;9(6):639–645.
- [9] Naito T, Onogi N, Taguchi T. Tire air pressure estimating apparatus. EP 925960A2. 1998.
- [10] Takeyasu T, Naito T, Onogi N, Hayashi I, Nishikawa Y. Tire Pneumatic Pressure Detector. EP 700798A1. 1996.
- [11] Lutz M, Hathout J, Kojic A, Partridge A, Ahmed J. Tire pressure and parameter monitoring system and method using accelerometers. US20030187555. 2003.
- [12] Borenus G, Braun F, Grünberg H. Method and apparatus for monitoring the tire pressure of motor vehicle wheels. EP 938987. 1999.
- [13] Shraim H, Rabhi A, Ouladsine M, M'Sirdi N, Fridman L. Estimation and analysis of the tire pressure effects on the compartment of the vehicle center of gravity. *International Workshop on Variable Structure Systems;* 268–273. 2006.
- [14] Singh K. Tire suspension fusion system for estimation of tire deflection and tire load. US20140260585. 2014.
- [15] Gustafsson F. Slip-based estimation of tire-road friction. *Automatica.* 1997;33(6):1087–1099.
- [16] Persson N, Gustafsson F, Drevö M. Indirect tire pressure Monitoring using Sensor Fusion. In: *SAE Technical Paper 2002-01-1250*; 2002. p. 1–6.
- [17] Anderson R, Bevely D. Estimation of tire cornering stiffness using GPS to improve model based estimation of vehicle states. *IEEE Intelligent Vehicles Symposium*; 2005. p. 801–806.

- [18] Reina G, Ishigami G, Nagatani K, Yoshida K. Odometry correction using visual slip angle estimation for planetary exploration rovers. *Adv Robotics*. 2010;24(3):359–385.
- [19] Doumiati M. *Vehicle dynamics estimation using Kalman filtering*. Hoboken (NJ): Wiley; 2013.
- [20] Ryu J. *State and parameter estimation for vehicle dynamics control using GPS*. Ph.D. thesis, Stanford, USA: Stanford University; 2004.
- [21] Sayers M, Karamihas S. *The Little book of profiling*. Ann Arbor, MI: University of Michigan; 1998.
- [22] Bittani S, Bolzern P, Campi M, Coletti E. Deterministic convergence analysis of RLS estimators with different forgetting factors. *Conference on Decision and Control*, Austin, TX; 1988. p. 1530–1531.
- [23] Ulsoy A, Peng H, Cakmakci M. *Automotive control systems*. New York: Cambridge; 2012.
- [24] ISO 8608: *Mechanical vibration – road surface profiles – reporting of measured data*. International Organization for Standardization; 1995.
- [25] Zuo L, Nayfeh SA. Structured H2 optimization of vehicle suspensions based on multi-wheel models. *Veh Syst Dyn*. 2003;40(5):351–371.