

11-1995

Uplink-Noise Limited Satellite Channels

Ted J. Wolcott

New Mexico State University - Main Campus

William P. Osborne

osborne@engr.siu.edu

Follow this and additional works at: http://opensiuc.lib.siu.edu/ece_confs

Published in Wolcott, T.J., & Osborne, W.P. (1995). Uplink-noise limited satellite channels. IEEE Military Communications Conference, 1995. MILCOM '95, Conference Record, v.2, 717-721. doi: 10.1109/MILCOM.1995.483559 ©1995 IEEE. Personal use of this material is permitted. However, permission to reprint/republish this material for advertising or promotional purposes or for creating new collective works for resale or redistribution to servers or lists, or to reuse any copyrighted component of this work in other works must be obtained from the IEEE. This material is presented to ensure timely dissemination of scholarly and technical work. Copyright and all rights therein are retained by authors or by other copyright holders. All persons copying this information are expected to adhere to the terms and constraints invoked by each author's copyright. In most cases, these works may not be reposted without the explicit permission of the copyright holder.

Recommended Citation

Wolcott, Ted J. and Osborne, William P., "Uplink-Noise Limited Satellite Channels" (1995). *Conference Proceedings*. Paper 57. http://opensiuc.lib.siu.edu/ece_confs/57

This Article is brought to you for free and open access by the Department of Electrical and Computer Engineering at OpenSIUC. It has been accepted for inclusion in Conference Proceedings by an authorized administrator of OpenSIUC. For more information, please contact opensiuc@lib.siu.edu.

UPLINK-NOISE LIMITED SATELLITE CHANNELS

Ted J. Wolcott and William P. Osborne
New Mexico State University

Abstract

Many applications, current and emerging, are faced with a relatively new and interesting channel model. Systems which transmit data through a nonlinear relay, such as a satellite, must deal with a composite channel that can be separated into two distinct channels — the uplink channel between the user and the relay, and the downlink channel between the relay and the final destination. If the system has a strict power limitation and high data rate demands, such as a small satellite transmitting through NASA's TDRSS Network, the dominant noise is present on the uplink rather than the downlink channel. Such a system is deemed to be uplink-noise limited and presents the designer with a number of problems not encountered in a more typical downlink-noise limited channel.

Whereas the transmitted signal constellation can be pre-distorted to take into account the effect of the nonlinearity in the down-link limited channel, no amount of pre-distortion will solve the problems encountered when the majority of the noise is present before the nonlinearity. Instead, the receiver must be modified to reflect the non-Gaussian noise due to the operation of the nonlinearity on Gaussian noise.

Under three assumptions — there is no downlink-noise present, the downlink channel is wideband relative to the data, and the filter preceding the nonlinearity meets both matched filter and Nyquist requirements — such modifications can be made based on the nature of the nonlinearity. By mapping the ideal decision region through the nonlinearity, performance almost identical to that of a linear-wideband AWGN channel can be achieved. This paper will develop the theoretical performance of the receiver described for a nonlinearity typical of a satellite channel. Performance curves will be presented for QPSK, 8PSK, 16PSK and 16QAM modulation schemes.

1.0 Introduction

The typical satellite channel can be described as down-link noise limited, and despite its nonlinear nature is relatively well behaved. The satellite channel, as well as many other relay channels containing a nonlinearity such as a high-power traveling-wave tube amplifier (TWTA), can be broken into two distinct channels as shown in Figure 1. For the typical satellite channel, the uplink channel — the signal path between the transmitter and the satellite — is very strong, contributing negligible noise distortion. The majority of the noise then is

present in the downlink channel, between the satellite and the receiver. Due to the near absence of uplink-noise, the input to the nonlinearity is well defined, allowing the output of the nonlinearity to be modeled as a finite-state machine.

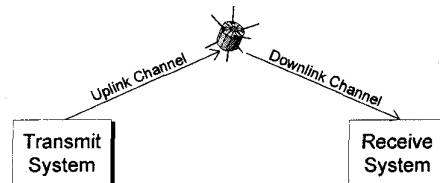

Figure 1 / Composite Satellite Channel

A great deal of research has been devoted to the downlink-noise limited channel. Konstantinides and Yao have studied linear equalization techniques for nonlinear bandlimited satellite channels [1,2]. Populin and Greenstein have investigated the use of signal predistortion, pulse shaping and filtering as well as linear equalization for improved performance in channels of this type [3]. Hwang and Kurz studied the effects of CW interferers in addition to additive white Gaussian noise (AWGN) on performance [4]. In his papers on Partial-Response Signaling [5,6], David Forney demonstrated the optimum transmitter/receiver pair for a linear bandlimited channel. His work was then extended to the nonlinear channel by Lorne Campbell et al. [7]. And, Kabal and Pasupathy presented a unified study of PRS in 1975 [8]. However each of these papers focuses on channels dominated by downlink-noise, often assuming there is no uplink noise present. This assumption, along with the assumption that the first satellite transponder filter can be effectively removed through equalization, allows the entire uplink channel to be modeled as a wire. In effect, the nonlinearity can be modeled as a part of the transmitter.

A number of new and existing applications ranging from small satellites transmitting through NASA's TDRSS network to handheld satellite telephones have presented the need for a solution to a different problem. In such applications, the originating transmit power can be limited in comparison to the relay transmit power. Thus, the channel can be better described as uplink-noise limited — the dominant noise distortion exists between the transmitter and the relay, not between the relay and the receiver. The problem is changed dramatically when the noise is added to the system before the relay nonlinearity. Although the solutions presented in the papers listed above, and derived for the downlink-noise limited channel, may do a fair job of reducing error rates, they are not optimal for this relatively new and interesting problem.

This work was supported by NASA grant NAG 5-1491.

Because the dominant noise distorts the transmitted signal before it reaches the nonlinearity, its output is no longer well defined and the finite-state machine model is no longer valid. This added problem has a significant effect on performance and is not dealt with in [1-8]. However, the approach taken in the solution of the downlink-noise limited problem can still be helpful.

This paper will take a similar approach in an attempt at solving the uplink-noise limited channel problem. Instead of treating the nonlinearity as part of the transmitter, assumptions will be made allowing it to be modeled as a part of the receiver. The uplink-noise limited channel is shown below in Figure 2a. If it is assumed that there is no downlink-noise and that the downlink channel is wideband relative to the data, — allowing the second transponder filter to be effectively removed through equalization — an equivalent model can be derived (Figure 2b).

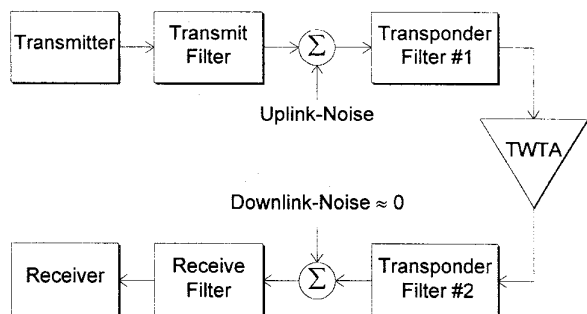

Figure 2a / Uplink-Noise Limited Channel Model

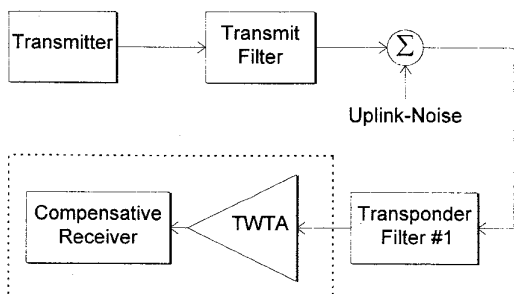

Figure 2b / Modified Uplink-Noise Limited Channel Model

A compensative receiver for a TWTA, based of the model shown in Figure 2b, will be presented in Section 2. In the optimal receiver derivation, an additional assumption will be made — that the transmit/transponder filter pair meet both Nyquist and Matched Filter specifications. Thus, the signal at the input to the nonlinearity will exhibit maximum signal-to-noise ratio (SNR) as well as no inter-symbol interference (ISI). In application, a tradeoff between the SNR and amount of ISI must be made. However, it will not affect the derivation of the optimal receiver. The theoretical performance of the receiver

will be developed in Section 3, for QPSK, 8PSK, 16PSK and 16QAM and conclusions will be made in Section 5.

2.0 TWTA Compensative Receiver

The theorem of reversibility [9], although not directly applicable to a nonlinear system, can be used for direction toward a solution to the uplink-noise limited problem. The theorem states that the minimum attainable probability of error is not affected by the introduction of a reversible operation at the output of a channel. Hence, if it was possible to perfectly reverse the effects of the nonlinear amplifier, which appears as an operation at the output of the uplink channel (Figure 2b), the performance of the system would be optimized. Assuming the transmit/transponder filter pair meet both Nyquist and Matched Filter specifications, the performance would be that of an ideal linear AWGN channel.

Due to the nature of the nonlinearity, its effects can not be perfectly reversed. However, it can be reversed over limited ranges of the input level — for either input levels above or below saturation. Hence, the approach taken will be to compensate for the nonlinearity for signal levels up to saturation and then determine the performance degradation due to imperfect compensation at levels above saturation.

Using Saleh's model [10], the amplitude-to-amplitude (AM/AM) and amplitude-to-phase (AM/PM) conversions due to the satellite's TWTA can be written as

$$a(r) = \frac{\alpha_r \cdot r}{1 + \beta_r \cdot r^2} \quad (1a)$$

$$\text{and } \phi(r, \theta) = \theta + \frac{\alpha_\phi \cdot r^2}{1 + \beta_\phi \cdot r^2}, \quad (1b)$$

where r and θ are the amplitude and phase of the complex baseband input, a and ϕ are the amplitude and phase of the complex baseband output. The coefficients α_r , β_r , α_ϕ , β_ϕ , are amplifier dependent constants. The input amplitude corresponding to saturation is

$$r_{sat} = \frac{1}{\beta_r}. \quad (2)$$

At this point, two separate signal spaces to be used throughout the derivation will be defined. Let S denote the complex signal space representing all possible complex baseband inputs to the nonlinearity. The complex signal space at the output of the nonlinearity will be denoted by S' and is related to S by Saleh's equations. The input space, S , has no limitation on possible signal points, allowing for signals of any phase or magnitude. However, due to the saturation characteristic of the TWTA, the output space is limited in magnitude to $a \leq a_{sat}$, where $a_{sat} \equiv a(r_{sat})$.

Compensation for the TWTA will be done by mapping the ideal decision regions, as best as can be done, through the nonlinearity — from S into S' . These mapped regions will then be used by the receiver in its decision making process. For PSK signaling, only phase information is needed to make proper estimates. So, writing ϕ in terms of a and θ is sufficient

to generate the correct decision regions. Assuming r is never greater than r_{sat} ,

$$\phi(a, \theta) = \theta + \frac{\alpha_\phi (\alpha_r^2 - \alpha_r \sqrt{\alpha_r^2 - 4a^2\beta_r^2} - 2a^2\beta_r^2)}{2a^2\beta_r^4 + \beta_\phi (\alpha_r^2 - \alpha_r \sqrt{\alpha_r^2 - 4a^2\beta_r^2} - 2a^2\beta_r^2)} \quad (3)$$

Any MPSK decision boundary, limited to $r \leq r_{sat}$, can be mapped using this equation by setting θ to the boundary phase and ranging the function over a , $0 \leq a < a_{sat} \equiv a(r_{sat})$. For example, the compensative regions for QPSK signaling are shown in Figure 3.

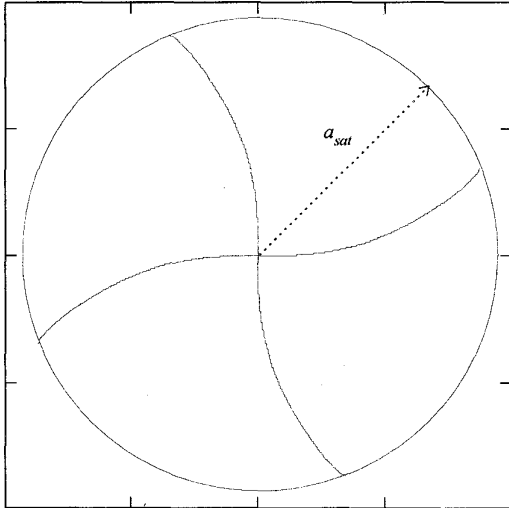

Figure 3 / QPSK TWTA-Compensative Decision Regions in S'

However, the definition of these compensative regions only accounts for a portion of the possible input levels. This equation only maps a portion of S into S' . It is not reasonable, in the presence of Gaussian noise, to assume any limitation on the signal level seen at the input to the nonlinearity. Therefore, the relationship between the rest of S and S' must be defined. This will be especially important when the receiver performance is derived in Section 3.

Based on Saleh's model, there exist two input points in S , (r_1, θ_1) and (r_2, θ_2) , that will map a given point (a, ϕ) in S' . Therefore, for each limited decision region in S , there is a corresponding region that can be defined for input amplitudes greater than r_{sat} . Both regions in S will map to the same region in S' . If these regions are defined a set of composite decision regions S can be found. These composite regions are in fact the decision regions seen by the receiver at the input to the TWTA.

To define the regions in S for $r > r_{sat}$, a procedure similar to that used to define the compensative regions will be followed. For the compensative regions, the limited ideal boundaries were mapped from S to S' . To define the set of corresponding regions, these boundaries will be mapped back from S' to S . However, instead of assuming $r \leq r_{sat}$, the contrary will be assumed. The net result will be the mapping of each point on a decision boundary first through the lower portion of

the nonlinear function, $r \leq r_{sat}$, and then back through the upper portion. Based on the nonlinear functions, r_2 can be written as functions of r_1 and θ_1 , while θ_2 can be written as a function of r_1, θ_1 and θ_2 .

$$r_2(r_1, \theta_1) = \frac{1}{2} \cdot \left[r_1 + \frac{1}{\beta_r \cdot r_1} + \sqrt{\left(r_1 + \frac{1}{\beta_r \cdot r_1} \right)^2 - \frac{4}{\beta_r \cdot r_1}} \right] \quad (4a)$$

$$\theta_2(r_1, r_2, \theta_1) = \theta_1 + \frac{\alpha_\phi \cdot r_1^2}{1 + \beta_\phi \cdot r_1^2} - \frac{\alpha_\phi \cdot r_2^2}{1 + \beta_\phi \cdot r_2^2} \quad (4b)$$

The resulting composite decision regions, as seen by the receiver at the input to the nonlinearity take the form shown in Figure 4 for QPSK signaling. Similar regions can be defined for higher order modulation.

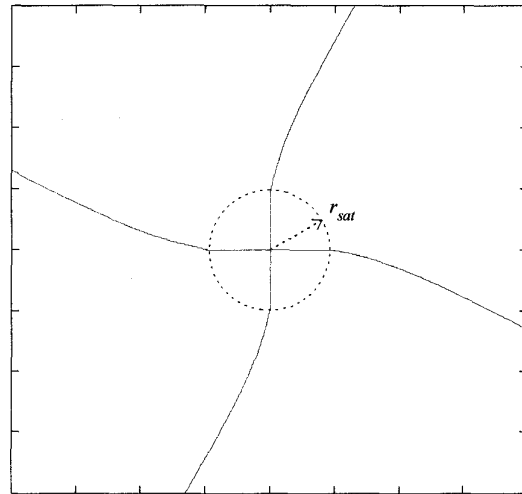

Figure 4 / Resulting QPSK Decision Regions in S

Clearly, these decision regions are not optimum. Any deviation from linear, radial decision boundaries will result in a degradation in performance because the optimum decision — choosing the transmit symbol closest in Euclidean distance to the received symbol — will not always be made. However, since the deviation is only slight near the expected input signal magnitude (in practice, $E[r] = \bar{r} \leq r_{sat}$), the degradation will only be slight. And, it is expected that the performance should degrade as \bar{r} approaches r_{sat} .

Following similar procedures, compensative decision regions can be found for higher order modulation schemes. The decision regions for 8PSK and 16PSK look very much like those of QPSK, with more decision boundaries. However, when the process is applied to multi-level decision regions, such as 16QAM, significant differences result between the compensative and ideal linear decision regions. Figures 5 and 6 demonstrate the compensative 16QAM decision regions and their appearance at the input of the nonlinearity.

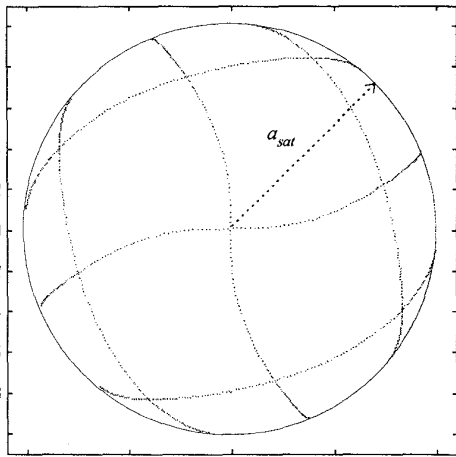

Figure 5 / 16QAM TWTA-Compensative Decision Regions in S'

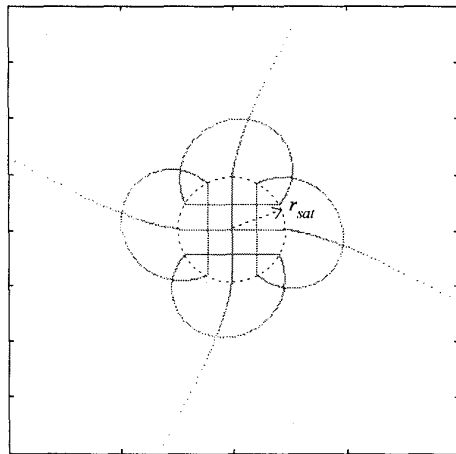

Figure 6 / Resulting 16QAM Decision Regions in S

3.0 Theoretical Receiver Performance

One obstacle in the performance analysis of systems which include a nonlinearity, especially an uplink-noise limited system, is that the AWGN noise introduced before the nonlinearity is not Gaussian at the receiver. Here, one advantage to the system design presented becomes apparent. Since the input to the receiver is effectively at the input to the satellite transponder, the noise is Gaussian. This allows standard error performance analysis techniques to be applied, using the suboptimal decision regions found in Section 2.

The theoretical performance of any MPSK receiver for additive equal-variance Gaussian noise can be found as follows [9].

$$P[\varepsilon] \equiv 1 - \sum_{i=0}^{M-1} P[s_i] P[C|s_i], \quad (5)$$

where $P[\varepsilon]$ is the probability of symbol error, $P[s_i]$ is the probability that symbol i was transmitted, and

$$P[C|s_i] \equiv \int_{I_i} p_r(\rho|s = s_i) d\rho \quad (6)$$

is the conditional probability that the symbol was estimated correctly, given symbol i was transmitted. I_i is defined to be the decision region corresponding to symbol i , and

$$p_r(\rho|s = s_i) = \frac{1}{\sqrt{2\pi\sigma^2}} e^{-|\rho - s_i|^2 / 2\sigma^2} \quad (7)$$

is the conditional probability function describing the received vector r , with noise variance $\sigma^2 = N_0/2$.

Equation 5 can be applied to arbitrary decision regions in S , such as those shown in Figures 4 and 6, to calculate the theoretical performance of a TWTA compensative receiver. The performance of a non-compensative receiver as well as that of an ideal receiver in a linear channel can also be found by applying the same equation to the proper regions. All integrations of the probability density functions were performed through finite summation.

Figures 7 and 8 present the performance of non-compensative and compensative receivers, respectively, in the ideal nonlinear channel presented here. Results are shown for MPSK ($M=4, 8$ and 16) and 16QAM for a nonlinear TWTA system operated at 0 dB input backoff ($\bar{r} = r_{sat}$). Included in each figure for comparison are the symbol error rate performance curves calculated for each modulation scheme by integration of the ideal decision regions. The values for Saleh's constants describing the TWTA nonlinearity were chosen to be $\alpha_r = 2.1587$, $\beta_r = 1.1517$, $\alpha_\phi = 4.0033$, $\beta_\phi = 9.1040$ [10].

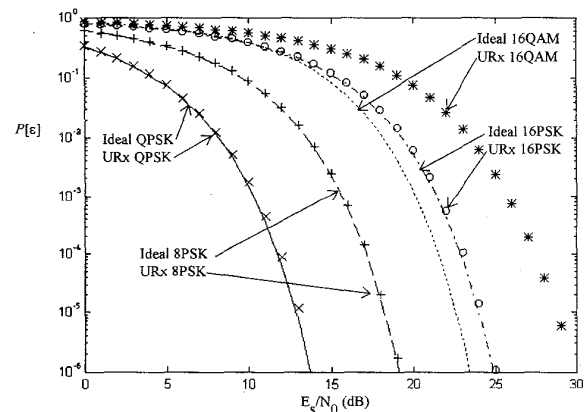

Figure 7 / Comparison of Ideal and Uncompensated (URx) Receiver SER Performance with AWGN

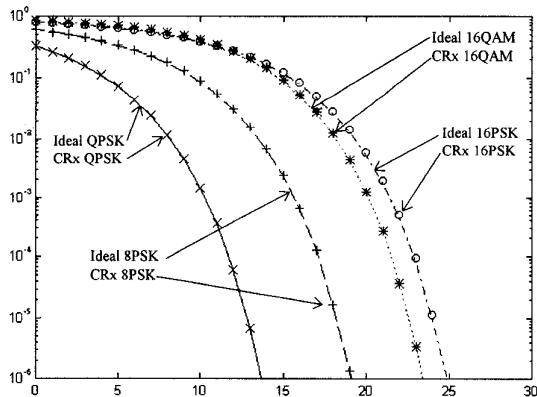

Figure 8 / Comparison of Ideal and Compensated (CRx) Receiver SER Performance with AWGN

This set of curves demonstrates two important features of the compensative receiver structure. First, the performance degradation for MPSK in this ideal channel is very slight, due to the constant envelope characteristic of the modulation format. Multilevel 16QAM does not fair as well, losing approximately 5dB in E_b/N_0 at an error rate of 1×10^{-5} .

Second, regardless of the modulation scheme, the performance of the compensative receiver is almost identical to that of the ideal AWGN system — the entire performance degradation is recovered — at error rates of interest. This corresponds to a performance gain of approximately 5dB for 16QAM, achieved through the relatively simple redefinition of decision regions.

4.0 Conclusions

The current trend in the field of satellite communication is toward smaller and faster satellites. The result of the higher data rates and lower transmit power for systems utilizing relay systems such as NASA's TDRSS is a channel described as uplink-noise limited. Due to the effects of the relay nonlinearity on the dominant noise, new techniques must be developed to maximize error performance.

This paper presented the derivation of a receiver structure designed to counteract the effects of a nonlinearity in an uplink-noise limited satellite channel with MPSK and 16QAM signaling. However, the ideas presented can easily be applied to any nonlinearity or modulation format.

The result was a system that, under a couple assumptions, achieved error rate performance very near that of a linear channel. Therefore, it was shown that almost all performance degradation due to the relay nonlinearity can be recovered through proper selection of decision regions in the receiver. This approach is relatively simple when compared to complex nonlinear equalization techniques and does not exhibit the information rate penalty associated with stronger forward error correction codes — both of which can be used to recover the performance loss.

It was shown that much higher gains can be attained when using multi-energy level constellations such as 16QAM, in the ideal nonlinear channel. For the TWTA parameters used here, the gain associated with the compensative 16QAM was approximately 5dB compared to an uncompensated receiver. Similar gains are expected for other multilevel modulation formats. The limited success found for the compensative MPSK receiver is not due to poor performance on the part of the receiver, but to the small amount to be gained. Higher gains are expected to be attained when this technique is applied to systems in which MPSK modulation is more strongly effected.

Due to the strong assumptions made, this is not a complete solution to the problem. It is however a very encouraging first step. Each assumption made — there is no downlink-noise, the downlink channel is wideband, and the transmit/transponder filter pair meet both the Nyquist and matched filter specifications — must be analyzed. More specifically, the effects of relaxing each assumption on error rate performance must be studied. Although the final results may not be as good as those presented here, it is hoped that a complete, realizable system will be found that exhibits gains over current methods of dealing with this unique channel, while minimizing complexity.

5.0 References

- [1] Konstantinides, K. & K. Yao, "Digital Data Transmission over Nonlinear Satellite Channels", *IEEE International Conference on Communications*, Toronto, 1986, pp. 1622-1626.
- [2] Konstantinides, K. & Yao, "Modeling and Computationally Efficient Time Domain Linear Equalisation of Nonlinear Bandlimited QPSK Satellite Channels", *IEEE Proceedings*, Vol. 137, No. 6, pp. 438-442, Dec. 1990.
- [3] Populin, S. & L. Greenstein, "Performance Analysis of Digital Radio Links with Nonlinear Transmit Amplifiers", *IEEE Journal on Sel. Areas in Comm.*, Vol. SAC-5, No. 3, pp. 535-546, April 1987.
- [4] Hwang, I. & L. Kurz, "Digital Data Transmission Over Nonlinear Satellite Channels", *IEEE Transactions on Comm.*, Vol. 41, No. 11, pp. 1694-1702, Nov. 1993.
- [5] Forney, D., "Maximum-Likelihood Sequence Estimation of Digital Sequences in the Presence of Intersymbol Interference", *IEEE Trans. on Inf. Theo.*, Vol. 18, pp. 363-378, May 1972.
- [6] Forney, D. & V. Eyuboglu, "Combined Equalizations and Coding Using Precoding", *IEEE Communications Magazine*, pp. 25-34, Dec. 1991.
- [7] Campbell, L. et al., "Maximum Likelihood Sequence Estimation of Binary Sequences Transmitted Over Bandlimited Nonlinear Channels", *IEEE Transactions on Comm.*, Vol. 25, No. 7, pp. 633-643, July 1977.
- [8] Kabal, P., & S. Pasupathy, "Partial-Response Signaling", *IEEE Transactions on Comm.*, Vol. 23, No. 9, pp. 921-934, Sept. 1975.
- [9] Wozencraft, J., & I. Jacobs, *Principles of Communication Engineering*, John Wiley & Sons, Inc. New York, 1965.
- [10] A. Saleh, "Frequency-Independent and Frequency-Dependent Nonlinear Models of TWT Amplifiers", *IEEE Transactions on Comm.*, 1981.