

Using HOMER[®] Software, NREL's Micropower Optimization Model, to Explore the Role of Gen-sets in Small Solar Power Systems

Case Study: Sri Lanka

T. Givler and P. Lilienthal

Technical Report
NREL/TP-710-36774
May 2005

NREL is operated by Midwest Research Institute • Battelle Contract No. DE-AC36-99-GO10337



Using HOMER[®] Software, NREL's Micropower Optimization Model, to Explore the Role of Gen-sets in Small Solar Power Systems

Case Study: Sri Lanka

T. Givler and P. Lilienthal

Prepared under Task No.PVP4.9001

Technical Report
NREL/TP-710-36774
May 2005

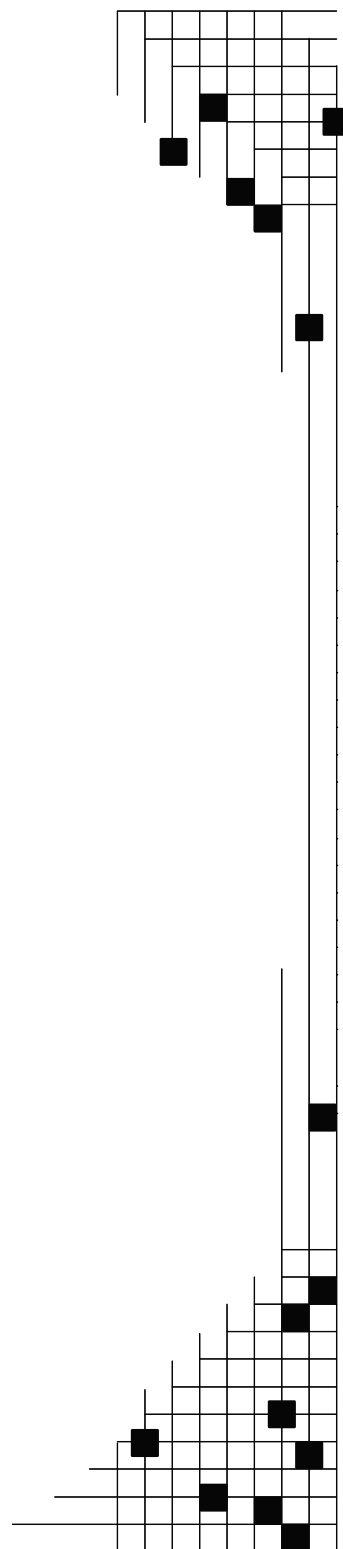

National Renewable Energy Laboratory
1617 Cole Boulevard, Golden, Colorado 80401-3393
303-275-3000 • www.nrel.gov

Operated for the U.S. Department of Energy
Office of Energy Efficiency and Renewable Energy
by Midwest Research Institute • Battelle

Contract No. DE-AC36-99-GO10337

NOTICE

This report was prepared as an account of work sponsored by an agency of the United States government. Neither the United States government nor any agency thereof, nor any of their employees, makes any warranty, express or implied, or assumes any legal liability or responsibility for the accuracy, completeness, or usefulness of any information, apparatus, product, or process disclosed, or represents that its use would not infringe privately owned rights. Reference herein to any specific commercial product, process, or service by trade name, trademark, manufacturer, or otherwise does not necessarily constitute or imply its endorsement, recommendation, or favoring by the United States government or any agency thereof. The views and opinions of authors expressed herein do not necessarily state or reflect those of the United States government or any agency thereof.

Available electronically at <http://www.osti.gov/bridge>

Available for a processing fee to U.S. Department of Energy and its contractors, in paper, from:

U.S. Department of Energy
Office of Scientific and Technical Information
P.O. Box 62
Oak Ridge, TN 37831-0062
phone: 865.576.8401
fax: 865.576.5728
email: <mailto:reports@adonis.osti.gov>

Available for sale to the public, in paper, from:

U.S. Department of Commerce
National Technical Information Service
5285 Port Royal Road
Springfield, VA 22161
phone: 800.553.6847
fax: 703.605.6900
email: orders@ntis.fedworld.gov
online ordering: <http://www.ntis.gov/ordering.htm>



Abstract

Stand-alone photovoltaic (PV) systems offer a cost-effective alternative to expensive grid extensions in remote areas of the world. In such applications, small solar home systems provide power for small fluorescent lighting and other small appliances. According to a survey conducted in Sri Lanka by the International Resources Group, most of the solar home systems there use a 50 W PV/battery system to power several compact fluorescent lights. Photovoltaic systems can also serve larger home or village loads that may include additional households, community centers, and street lighting. In a hybrid power system, a back-up diesel generator supplements the PV power for peak loads and during poor resource periods and can cost less than a PV-only system. For example, a 20-kW PV/75-kW diesel hybrid system in Gaize, Tibet meets a daily energy consumption of 75 kWh for a village of 1000 people. Somewhere between these two points the inclusion of a diesel backup improves the economics of the system. This study used HOMER to explore the threshold load size at which it is more cost-effective to include a diesel than to increase the size of the battery bank or PV array. By performing multiple sensitivity analyses, the economic crossover point between these two system types was determined over a range of system sizes, solar resources, fuel prices, and reliability requirements. Depending on these factors the crossover varied from 3 – 13 kWh day.

The HOMER software, NREL's micropower optimization model, can evaluate a range of equipment options over varying constraints and sensitivities to optimize small power systems. HOMER's flexibility makes it useful in the evaluation of design issues in the planning and early decision-making phase of rural electrification projects.

TABLE OF CONTENTS

Abstract	iii
Introduction	1
Assumptions and Model Inputs	2
Load	2
Solar Resource	2
Diesel Fuel Price	3
Economics	3
Reliability Constraint	3
Equipment Considered	3
Photovoltaic Panels	4
Batteries	4
Converters	4
Generators	4
Results and Discussion	5
Determination of Load Thresholds	5
Effect of Allowing Unserved Load	5
Changes in the Global Solar Resource	7
Effect of Fuel Price	8
Challenges in the Analysis Process	9
Conclusion	10
Glossary	10
References	11
Appendix A: HOMER Input Data	12
Appendix B: Solar Resource Data Maps (Dmaps) for Sri Lanka and Southern Egypt	16
Appendix C: Cost of Energy vs. Load Graphs	18
Appendix D: OST Graphs Showing Maximum Annual Capacity Shortage vs. Load	19
Appendix E: Hourly Load and Production Profiles	21
Appendix F: Total Electrical Output and Generator Output vs. Load Graphs	23

Introduction

Stand-alone solar photovoltaic (PV) systems offer a cost-effective alternative to expensive grid extensions in remote areas of the world. In such applications, solar home systems provide power for a few small fluorescent lights and other small appliances. According to a survey conducted in Sri Lanka by the International Resources Group, most of the solar home systems there use a 50-W PV/battery system to power several compact fluorescent lights [1]. Solar home systems may be quite cost-effective when compared to the operation, maintenance, and fuel cost of electricity from diesel generators. As the load requirements increase, however, the addition of a back-up diesel generator often makes a PV/diesel hybrid system a more viable option, even with high fuel costs. The load for a village system may include households as well as a community center, schools, and street lighting. For example, a 20-kW PV/75-kW diesel hybrid system in Gaize, Tibet meets a daily energy consumption of 75 kWh for a village of 1000 people [2]. The addition of a backup generator to the PV system serves load peaks and provides power when cloudy weather limits the solar resource. The generator allows for smaller PV and battery components, which reduces system costs, while the PV and batteries limit the diesel fuel consumption.

The HOMER software, NREL's micropower optimization model, can evaluate a range of equipment options over varying constraints to optimize small power systems. This type of analysis could aid in the planning of large-scale rural electrification projects. The results could then serve as a starting point for the design of individual installations.

This study explored the role of backup generators to reduce overall system costs. We focused on Sri Lanka because it has an extensive program of small solar home systems with continuing efforts to electrify rural areas. HOMER simulated the operation of thousands of different system designs, with and without a backup generator. It was then able to identify the least cost system as a function of load size and other variables. This paper uses those results from HOMER to analyze the load threshold above which a hybrid PV/diesel/battery system becomes more cost-effective than a simpler PV/battery system. HOMER makes clear the sensitivity of this threshold to several factors.

Of the energy-modeling software available, HOMER's capabilities provide the best option for modeling and investigating such scenarios. The program first runs an hourly simulation of all possible configurations of system types. The speed of processing these simulations allows for the evaluation of thousands of combinations. This hourly simulation also provides improved accuracy over statistical models that typically evaluate average monthly performance of a system. HOMER also models the partial load efficiency of diesel generators. This more accurately simulates the lower efficiency of a generator when it is not operating at full capacity.

After running the simulations, HOMER sorts the feasible cases in order of increasing net present (or lifecycle) cost. This cost is the present value of the initial, component replacement, operation, maintenance, and fuel costs. HOMER lists the optimal system configuration, defined as the one with the least net present cost, for each system type. HOMER's sensitivity analysis then repeats this optimization as user-defined factors, such as fuel price, load size, reliability requirement, and resource quality are varied.

Assumptions and Model Inputs¹

Load

The load profile is based on a hypothetical single home. Figure 1 illustrates this profile. A small base load of 5 W occurs throughout the day and night. Small peaks of 20 W occur in the morning and at noon, while the majority of the load occurs in the evening. This evening load, with a peak load of 40 W, would likely include compact fluorescent lighting and a radio.

The total daily load averages 305 watt-hours per day.

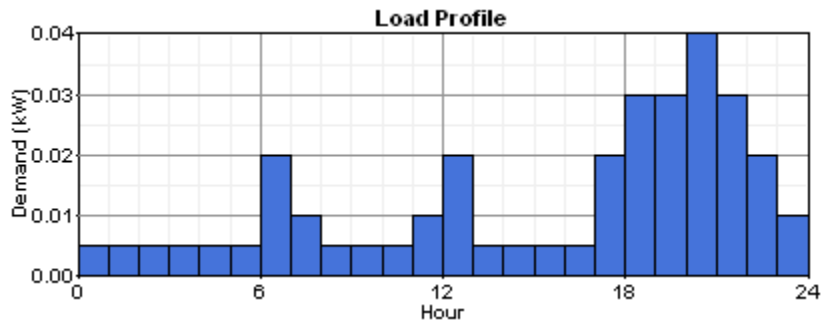

Figure 1. Hourly load profile

HOMER can perform a sensitivity analysis by accepting multiple values for a particular input variable such as the average load. By scaling the annual average value of kWh/d, HOMER models the impact of increasing loads. This analysis determines how changes in the input variable affect the performance of the system and the relative ranking of different systems. By performing the sensitivity analysis over a large range of load sizes, the study simulates a range of load types from a single home to a large community. While this scaling may represent the overall total load of a larger village, in reality the profile would not necessarily remain the same shape. Variations in individual home loads would tend to smooth out the overall profile. Additionally, daytime loads such as microenterprises, schools, and clinics would most likely change the shape of the profile. For simplicity of analysis, the load profile was not modified as the load was increased, but rather kept constant in shape and scaled in size. The sensitivity analysis was performed over a scaled range from 0.3 kWh/d to 16 kWh/d. Further analysis is required to determine the effect of changes in the load shape.

Solar Resource

The solar resource was used for a site in Sri Lanka at a location of 7° 30' N latitude and 81° 30' E longitude. Solar radiation data for this region was obtained from the NASA Surface Meteorology and Solar Energy web site [3]. The annual average solar radiation for this area is 5.43 kWh/m²/d. Figure 2 shows the solar resource profile over a one-year period. Additional runs were made using solar profiles from Southern Egypt. This provided insights into the effect of higher solar radiation on the system type. Appendix B illustrates the solar resources for Sri Lanka and Southern Egypt.

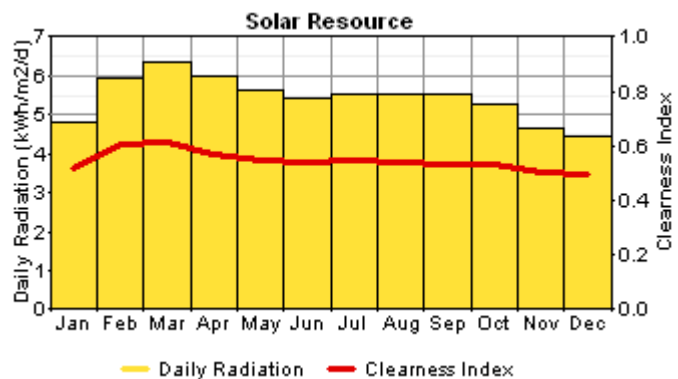

Figure 2. Solar Radiation profile for Sri Lanka

¹ Appendix A provides additional detail for model inputs.

Diesel Fuel Price

The study included a sensitivity analysis on the price of diesel fuel. This price can vary considerably based on region, transportation costs, and current market price. Price information from both the World Bank and the International Energy Agency (IEA) show that average diesel prices ranged from \$0.40/L to \$0.70/L in 2000 [4,5]. Prices of \$0.30/L to \$0.80/L were evaluated in increments of \$0.10/L.

Economics

A real annual interest rate of 6% was assumed. The real interest rate is equal to the nominal interest rate minus the inflation rate. The appropriate value for this variable depends on current macroeconomic conditions, the financial strength of the implementing entity, and concessional financing or other policy incentives. HOMER converted the capital cost of each component to an annualized cost by amortizing it over its component lifetime using the real discount rate.

Reliability Constraint

The economic performance of a renewable energy system can be significantly improved if a small portion of the annual load is allowed to go unserved. For example, a solar array and battery bank that do not have to meet an occasional large load may be significantly smaller than those that must meet the load at all times. This is especially true for those extreme cases with a peak load that occurs after several cloudy days. If it is acceptable for the system to be down for a small fraction of the year, or if unnecessary loads can be shed when the battery bank is low, significant capital cost may be saved. HOMER models this scenario with the maximum annual capacity shortage constraint. Set to 0% by default (in which the system must meet all of the load all of the time) a sensitivity analysis on this variable shows that the optimal system type might change if a small amount of the annual load (1/2% to 5%) is allowed to go unserved.

Equipment Considered

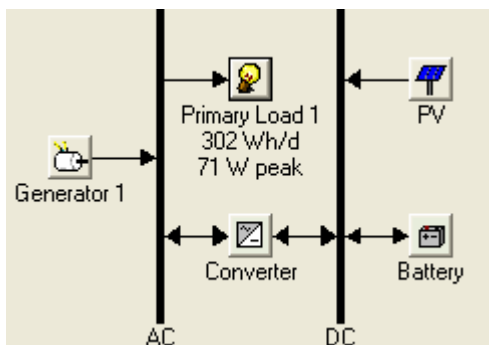

The search space, list of system component sizes, that HOMER considered for this analysis is outlined in Table 1. All equipment details, including the generator fuel efficiency curves, can be found in Appendix A.

Table 1. System Components Considered

Component	Size	Capital Cost (\$)	Replacement Cost	O&M Cost (\$)	Lifetime
PV Panels	0.05 – 5.0 kW (see Appendix A for specific sizes)	\$7,500/kW	\$7,500/kW	0.00	20 years
Trojan T-105 Batteries	225 Ah / 6 volt (bank size: 1 – 54 batteries)	\$75/battery	\$75/battery	\$2.00/year	845 kWh of throughput per battery
Converter	0.1 – 4.0 kW	\$1,000/kW	\$1,000/kW	\$100/year	15 years
Generator	4.25 kW	\$2,550	\$2,550	\$0.15/hour	5000 hours

Photovoltaic Panels

Photovoltaic panels were specified with capital and replacement costs of \$7.50/W. This cost includes shipping, tariffs, installation, and dealer mark-ups. Some maintenance is typically required on the batteries in a PV system, but very little is necessary for the panels themselves. A derating factor of 90% was applied to the electric production from each panel. This factor reduces the PV production by 10% to approximate the varying effects of temperature and dust on the panels. The panels were modeled as fixed and tilted south at an angle equal to the latitude of the site.

Batteries

HOMER uses the Kinetic Battery Model and represents batteries as a “two tank” system. One tank provides immediately available capacity while the second can only be discharged at a limited rate. Trojan T-105s were chosen because they are a popular and inexpensive option. HOMER considered up to 54 of these batteries. In a real installation a smaller number of larger batteries, such as the Trojan L-16, would be preferable. The economic analysis performed by HOMER would not be significantly affected by this distinction.

Converters

The inverter and rectifier efficiencies were assumed to be 90% and 85% respectively for all sizes considered. HOMER simulated each system with power switched between the inverter and the generator. These devices were not allowed to operate in parallel. In this simple system, power cannot come from both the generator and the batteries at the same time.

Generators

A vast range of diesel generators is available. The various manufacturers and distributors provide different information that can be difficult to compare. The partial load efficiency is an important parameter that HOMER requires when simulating this component. The generators were not allowed to operate at less than 30% capacity. Operation and maintenance costs for the generators are listed per hour of operation. HOMER determines the amount of time the generator must be used in a year and calculates the total operating costs from this value. The costs used for this study are very conservative and may be much higher in reality. Only one generator was allowed per system and that generator had to be large enough to meet the peak load. HOMER considered two different types of control strategies. Under the

load-following strategy, the generator provides only the power necessary to meet the load at the time. With the cycle-charging strategy, once the generator is operating, it uses as much power as possible to charge the batteries in addition to meeting the load.

Results and Discussion

The cost of energy was first calculated and plotted for the three system types over increasing loads to identify the load threshold between PV and a hybrid system. Variations in reliability, solar resource, and diesel price shift this threshold.

Determination of Load Thresholds

As the system load increases, the cost of energy curves identify specific load thresholds for different system types. Figure 3 shows the results for systems with 100% reliability, global solar radiation of 5.43 kWh/m²/d, and a diesel price of \$0.50/L. The PV/battery system has the lowest cost of energy for small loads up to about 3.5 kWh/d at a cost of energy (COE) of \$0.85/kWh. At this point, the hybrid PV/diesel/battery curve intersects the PV/battery curve. Loads above this threshold are best served by a hybrid system. At higher loads, the diesel/battery system has a lower cost of energy than the PV/battery system. However, the hybrid system is less expensive than either technology on its own. Appendix C includes additional graphs of the cost of energy vs. load for various combinations of reliability, solar radiation, and diesel price.

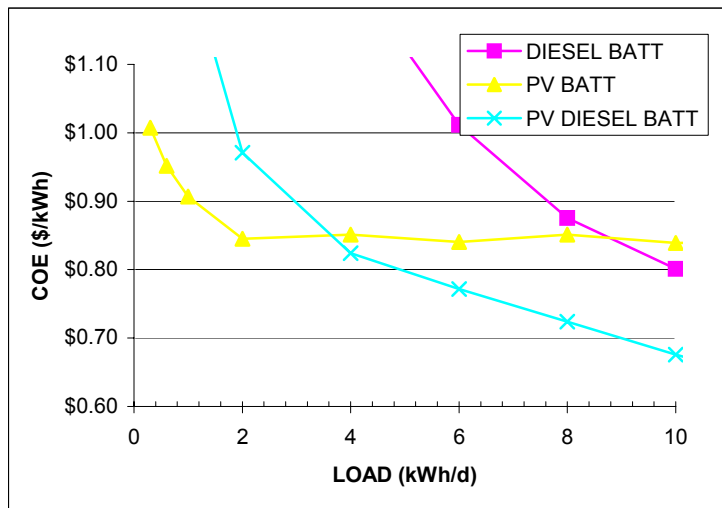

Figure 3. Cost of energy for (3) different system types over increasing load

Note: The assumptions used to create these results can be viewed by downloading files: diesel batt system 2.hmr; pv only system 3.hmr; pv diesel system 6.hmr at <http://www.nrel.gov/homer/>

Effect of Allowing Unserved Load

By introducing some annual capacity shortage to the HOMER simulations, the threshold where PV/diesel/battery systems become more cost-effective than PV/battery system increases to higher loads. Allowing some of the load to go unserved throughout the year means that the PV array and battery bank do not need to be sized for extreme, worst-case scenarios of extended cloudy weather and peak loads. The

lower capital cost allows such systems to compete with PV/diesel/battery hybrid systems when serving larger loads. This can be seen in Figure 4, which shows the HOMER Optimal System Type (OST) graph for various values of load and maximum annual capacity shortage. As the allowable capacity shortage increases on the y-axis, the area where PV/battery systems are the least-cost solution expands over larger loads. When the diesel fuel price increases to \$0.80/L in the graph on the right, the PV system becomes even more competitive with the hybrid system. The graphs also show that the fuel price has much less effect on small systems that require 100% reliability than on systems that allow a little bit of capacity shortage. This reflects the fact that systems that are primarily PV but require 100% reliability may only need to run the diesel for a very few number of hours to achieve that level of reliability. With that little diesel run-time, the diesel fuel price does not have a large effect on the overall economics.

Additional OST graphs showing maximum annual capacity shortage are included in Appendix D. As shown in Figure 5, even a half percent allowance of capacity shortage may result in a significant decrease (20%) in the net present cost, making the PV/battery system type more cost-effective.

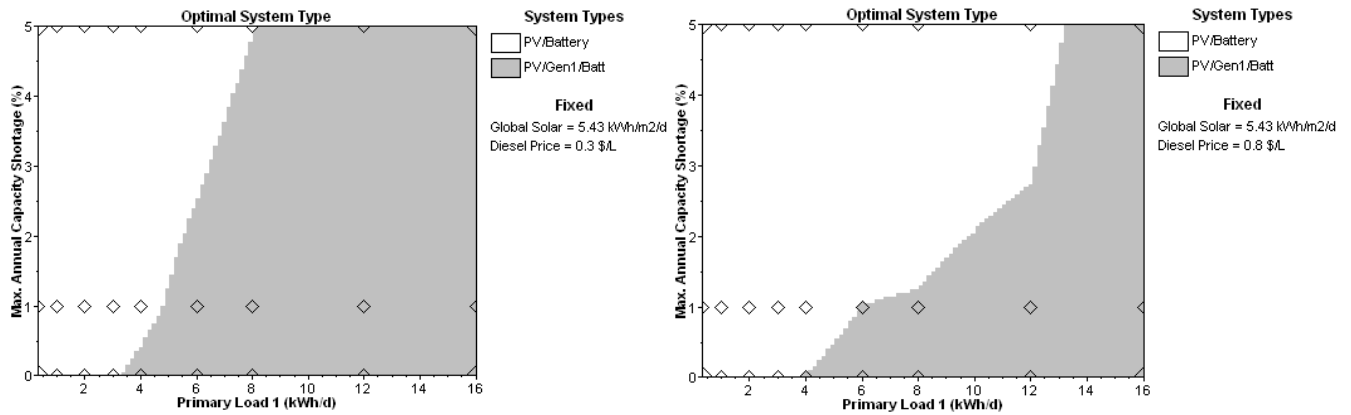

Figure 4. Optimal System Type (OST) graph over increasing capacity shortage and load.

The graph on the right shows how a PV/battery system becomes more competitive as more capacity shortage is allowed. When fuel cost is increased from \$0.30/liter (left graph) to \$0.80/liter (right graph), the new graph illustrates that a PV/battery system becomes even more cost competitive at higher loads.

Note: The assumptions used to create these results can be viewed by downloading the file: home system PV diesel range A11 (Sri Lanka) for figure 4, and file: home system pv diesel range A13.hmr for figure 5 at <http://www.nrel.gov/homer>

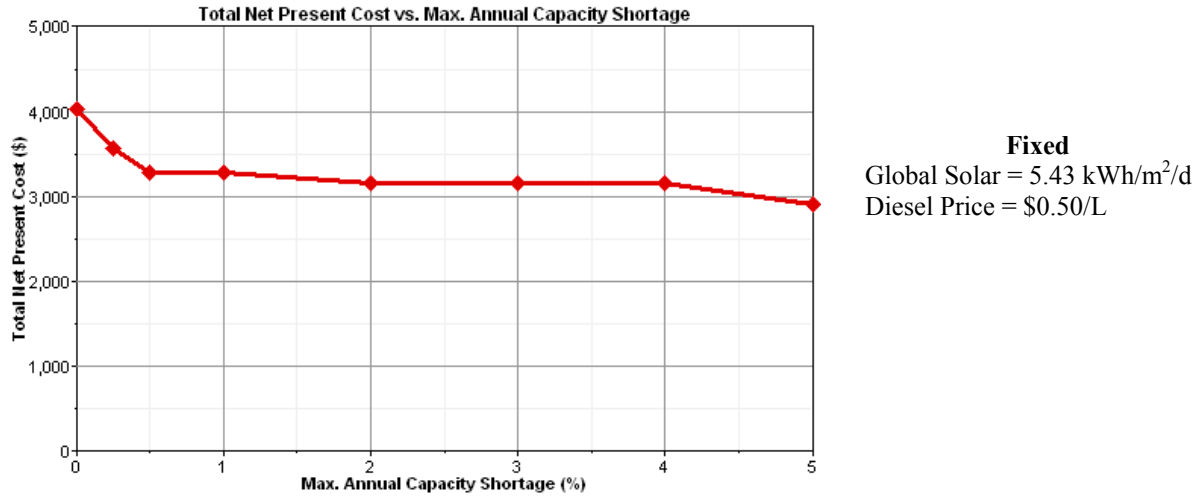

Figure 5. Net Present Cost vs Max Annual Capacity Shortage for a load of 1.0 kWh/d and a fuel cost of \$0.50/L. This graph illustrates that allowing just a small amount of unserved load can significantly reduce the cost of the system. Allowing even more unserved load may only bring much smaller additional savings. It is important to note that as the capacity shortage changes, both the system type and configuration may also change.

Changes in the Global Solar Resource

The same simulations were run with variations in the available global solar radiation to evaluate the effect of the solar resource on the load thresholds and optimal system types. A solar profile of southern Egypt provided a region with higher average solar radiation than Sri Lanka. The load thresholds changed with these changes in radiation and affected the load range where a PV/battery system was more cost-effective than a PV/battery/diesel hybrid. By increasing the solar resource, the PV/battery system type becomes optimal over a larger range of loads. These effects on the optimal system type are illustrated by the graphs in Figure 6. Appendix E includes the hourly load and electrical production profiles for a system at different times of the year, showing the effect of seasonal variations in solar radiation.

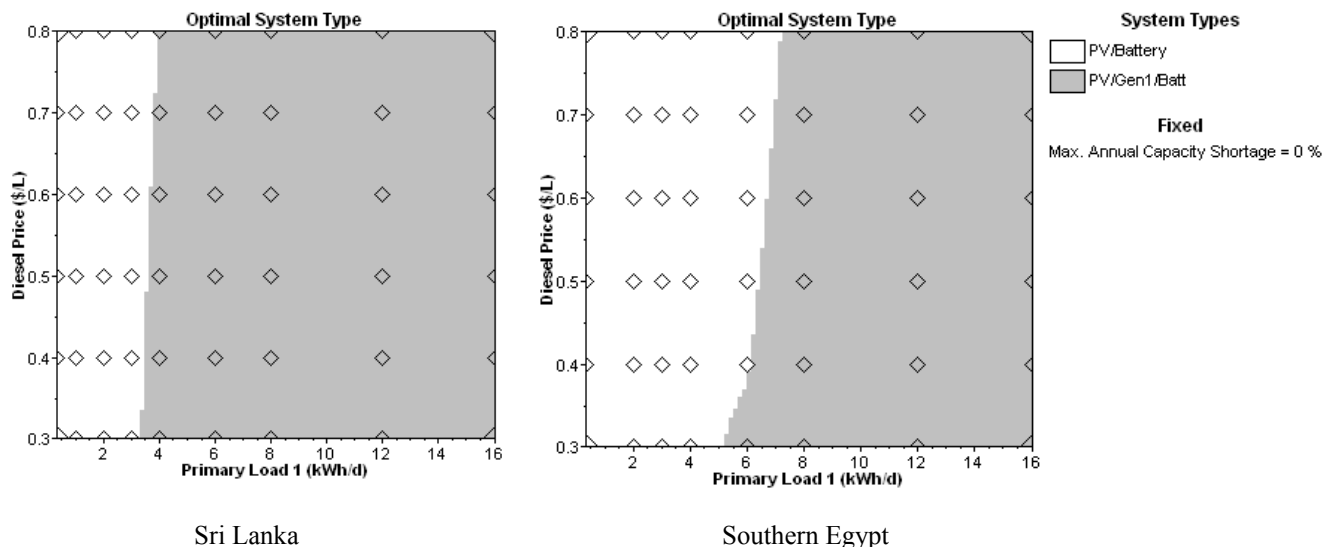

Figure 6. OST graphs over increasing load and fuel price for both Sri Lanka and Southern Egypt solar radiation profiles. The increased solar radiation of the Egypt profile increases the area of the graph where a PV/battery system is most cost-effective.

Note: The assumptions used to create these results can be viewed by downloading the files: home system pv diesel range A11 (Sri Lanka).hmr and home system pv diesel range A11-Egypt 8.hmr at <http://www.nrel.gov/homer/>

Effect of Fuel Price

The OST graph for Sri Lanka in Figure 6 shows that diesel fuel price has little impact on the cost effective threshold between a PV/battery and a PV/diesel/battery system. The line separating the PV and hybrid systems is nearly vertical. However, if some unserved load is allowed throughout the year, the fuel price becomes more important to the optimal system type. Figure 7 shows that when 5% capacity shortage is allowed, larger PV/battery systems becomes more cost competitive compared to the hybrid at all fuel prices. If 100% reliability is required, a diesel generator is often needed to meet that constraint although it may run only a few hours a year. In this case, the fuel price plays a small role in the overall net present cost. However, when the reliability constraint is lowered, the diesel would only be included in an optimal system if it becomes cost-effective to run it more often. This explains why the results in Figure 7, where 5% capacity shortage was allowed, show a greater sensitivity to fuel price.

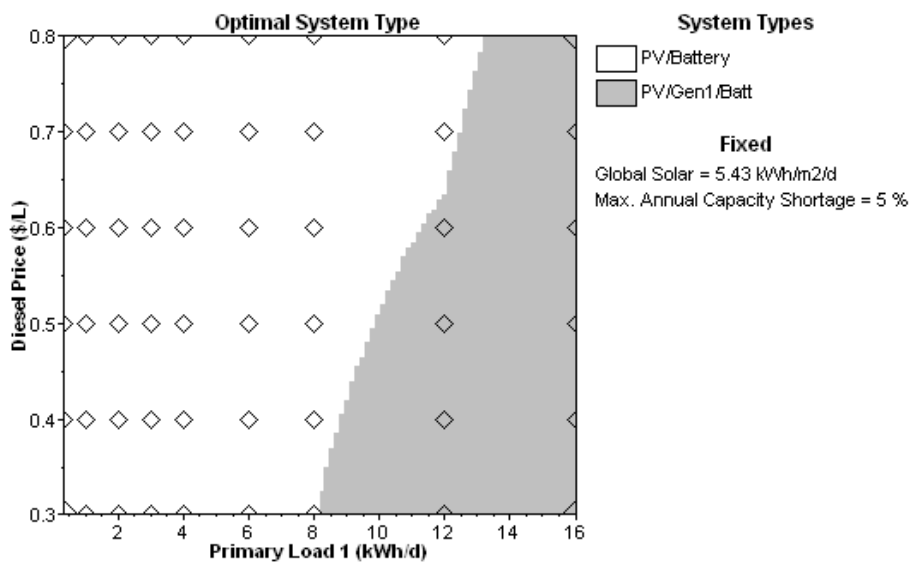

Figure 7. OST graph over increasing load and fuel price for Sri Lanka and a maximum allowable capacity shortage of 5%. Compared to the graph shown in Figure 6 for Sri Lanka, this OST graph is much more affected by change in diesel price than at 0% capacity shortage.

Challenges in the Analysis Process

When performing a sensitivity analysis on the load, many sizes of each equipment type must be considered to meet the range of loads evaluated. To reduce the computation times HOMER runs were performed in an iterative process. Initially, the optimization search space considered only a few component sizes over a large range. Similarly, the sensitivity analyses covered a large range with few points. This helped to decrease the initial run-time. With each successive run, more options and variables were added to increase the resolution and fill in the search and sensitivity spaces. For example, the final results shown previously illustrate a sensitivity analysis of the diesel price over a range of \$0.30/L to \$0.80/L with \$0.10/L increments. However, most iterative runs performed included prices of \$0.30, \$0.50, and \$0.80 only. This “coarser” sensitivity space provided adequate information to modify the file and rerun the simulations. The 2.1 version of HOMER incorporates the recycling of previous results to facilitate this iterative process.

Insufficient resolution in the HOMER search space can result in odd peaks and valleys in an OST graph. Such points result when the program must choose from a limited range of equipment sizes although interim sizes would better suit a particular simulation. Smoother curves result on the OST graph when HOMER has many equipment sizes to evaluate. Increasing the search space resolution smoothes the area boundaries of the OST graph. This is particularly problematic when performing sensitivities over load size. A larger load may require a larger genset running at a less efficient operating point.

Obtaining data for analyses such as these is always challenging. This is especially true for the wide variety of gensets that are commercially available. It is often hard to know a priori which inputs deserve a lot of effort getting precise data. Rough estimates of variables, such as O&M cost, lifetime, and part-load efficiency, can be entered into the program. A HOMER sensitivity analysis on these variables can then inform the user of the value of improving the accuracy of that input variable.

Conclusion

PV/battery systems were found to be most cost-effective up to loads ranging from 3 kWh/d to 13 kWh/d depending on the reliability, solar resource, and diesel fuel price. Loads above this threshold were best served by a hybrid PV/generator/battery system. Reliability requirements, solar resource, and fuel price all shift the exact threshold for a particular situation.

By allowing some small percentage of the load to go unserved throughout the year, the PV/battery system becomes more cost-competitive with hybrid systems over a larger range of loads. In applications where some capacity shortage is acceptable throughout the year, the capital cost can be significantly reduced. Even a small amount (1/2%) of capacity shortage can significantly improve the competitiveness of PV/battery systems.

HOMER confirmed the intuitive notion that locating a system in a region of higher average solar radiation favors PV/battery systems relative to hybrid systems moving the threshold to larger loads.

Where high reliability was required, fuel price had surprisingly little effect on the threshold between PV/battery and hybrid systems over the range of small systems considered here. However, if some unserved energy was allowed in the system, it became a more prominent factor.

Glossary

feasible system: A system that satisfies the specified constraints.

levelized cost of energy: The average cost of producing one kilowatt-hour of electricity, including capital, replacement, fuel, operating and maintenance costs.

maximum annual capacity shortage: The percentage of the yearly total load that is allowed to go unserved by the system.

net present cost: The present value of the cost of installing and operating the system over the lifetime of the project (also referred to as lifecycle cost).

optimal system type: The combination of power-generation technologies with the lowest net present cost.

renewable energy fraction: The portion of a system's total electrical production that originates from renewable power sources.

search space: The set of all system configurations that HOMER evaluates.

sensitivity analysis: An investigation into the extent to which changes in certain inputs affect a model's outputs.

system type: A combination of power-generation technologies.

References

1. International Resources Group. “World Bank/Sri Lanka Energy Services Delivery Project, Impacts Assessment and Lessons Learned.” Washington, DC, 2003.
2. “PV/Diesel Hybrid in Gaize, Tibet.” Renewables for Sustainable Village Power (RSVP) Village Power Database, <http://www.rsvp.nrel.gov/asp/project.asp?ID=225>. Accessed May 2004.
3. NASA Surface Meteorology and Solar Energy. <http://eosweb.larc.nasa.gov/sse/>. Accessed May 2004.
4. Bacon, Robert. “Petroleum Taxes.” The World Bank. <http://rru.worldbank.org/Documents/PublicPolicyJournal/240Bacon-831.pdf>, September 2001.
5. “Energy Policies of IEA Countries.” <http://library.iea.org/dbtw-wpd/textbase/nppdf/free/2000/comp2000.pdf>, OECD/IEA, 2000.

Appendix A: HOMER Input Data

HOMER Input Summary – Range A

File Name: Range A.hmr

Notes: Solar and Diesel with increasing load (0.3-16 kW); does not allow generators that are less than the peak load; does not allow multiple generators; inexpensive generator 1 with low lifetime; inverter cannot operate simultaneously with generator; no fixed cost on pv panels; battery O&M cost added; solar resource for Sri Lanka; reduced cost for Trojan batteries per website information; project life decreased to 20 years;

AC Load: Primary Load 1

Data source: Synthetic

Scaled annual average: 0.3, 1.0, 2.0, 8.0, 12.0, 16.0, 4.0, 6.0, 3.0 kWh/d

Daily noise: 15%

Hourly noise: 20%

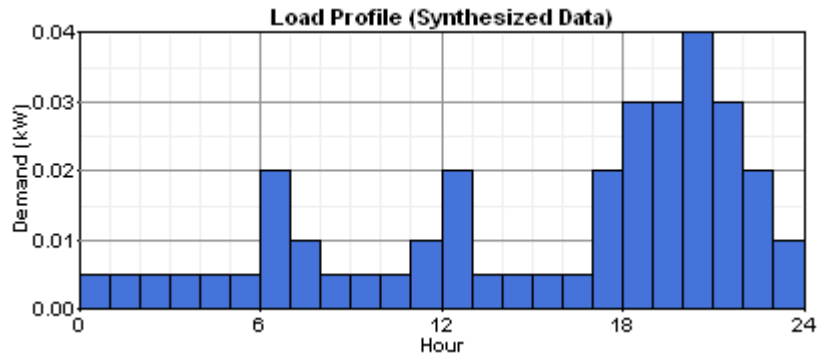

PV

PV costs

Size (kW)	Capital (\$)	Replacement (\$)	O&M (\$/yr)
0.04	300	300	0
1.04	7,800	7,800	0

Sizes to consider: 0.00, 0.05, 0.10, 0.20, 0.25, 0.30, 0.40, 0.50, 0.75, 1.00, 1.25, 1.50, 2.00, 2.50, 3.00, 3.50, 4.00, 5.00 kW

Lifetime: 20 yr

Derating factor: 90%

Tracking system: No Tracking

Slope: 7.5 deg

Azimuth: 0 deg

Ground reflectance: 20%

Solar Resource

Data source: Synthetic

Month	Clearness index	Average radiation
		(kWh/m2/d)
Jan	0.522	4.80
Feb	0.606	5.94
Mar	0.617	6.37
Apr	0.573	6.00
May	0.548	5.62
Jun	0.540	5.43
Jul	0.548	5.54
Aug	0.538	5.55
Sep	0.534	5.51
Oct	0.534	5.29
Nov	0.502	4.67
Dec	0.497	4.46

Scaled annual average: 4.46, 6.37, 5.43 kWh/m2/d

Latitude: 7 degrees 30 minutes North

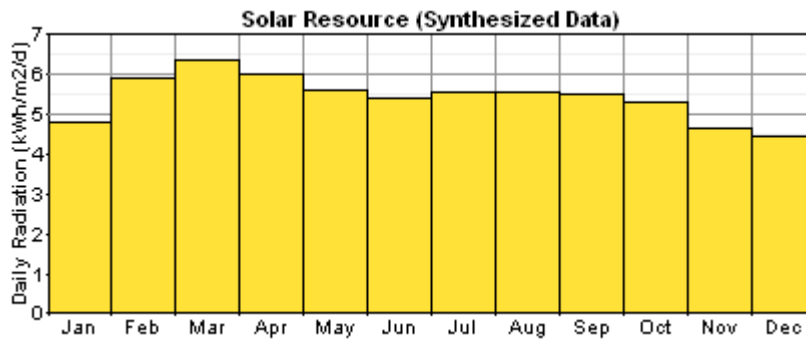

AC Generator: Generator 1

Generator 1 costs

Size (kW)	Capital (\$)	Replacement (\$)	O&M (\$/hr)
4.25	2,550	2,550	0.15

Sizes to consider: 0.00, 4.25 kW
Lifetime: 5,000 hrs
Min. load ratio: 30%
Heat recovery ratio: 0%
Fuel used: Diesel
Fuel curve intercept: 0.0911 L/hr/kW
Fuel curve slope: 0.264 L/hr/kW

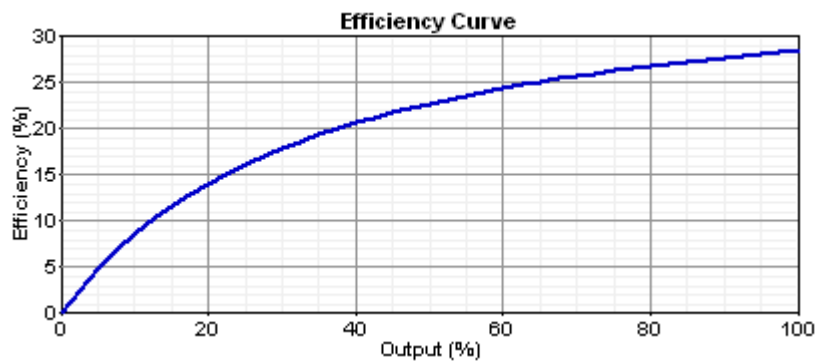

Fuel: Diesel

Price: \$ 0.3, 0.5, 0.8, 0.4, 0.6, 0.7/L
Lower heating value: 43.2 MJ/kg
Density: 820 kg/m³
Carbon content: 88.0%

Battery: Trojan T-105

Battery costs

Quantity	Capital (\$)	Replacement (\$)	O&M (\$/yr)
1	75	75	2

Quantities to consider: 0, 1, 2, 4, 6, 8, 10, 12, 16, 18, 24, 30, 36, 42, 48, 54
Voltage: 6 V
Nominal capacity: 225 Ah
Lifetime throughput: 845 kWh

Converter

Converter costs

Size (kW)	Capital (\$)	Replacement (\$)	O&M (\$/yr)
1	1,000	1,000	100

Sizes to consider: 0.00, 0.10, 0.15, 0.20, 0.40, 0.50, 0.75, 1.00, 1.25, 1.50, 2.50, 3.00, 4.00 kW
Lifetime: 15 yr
Inverter efficiency: 90%
Rectifier relative capacity: 100%
Rectifier efficiency: 85%

Economics

Annual real interest rate: 6%
Project lifetime: 20 yr
Capacity shortage penalty: \$ 0/kWh
System fixed capital cost: \$ 0
System fixed O&M cost: \$ 0/yr

Appendix B: Solar Resource Data Maps (Dmaps) for Sri Lanka and Southern Egypt

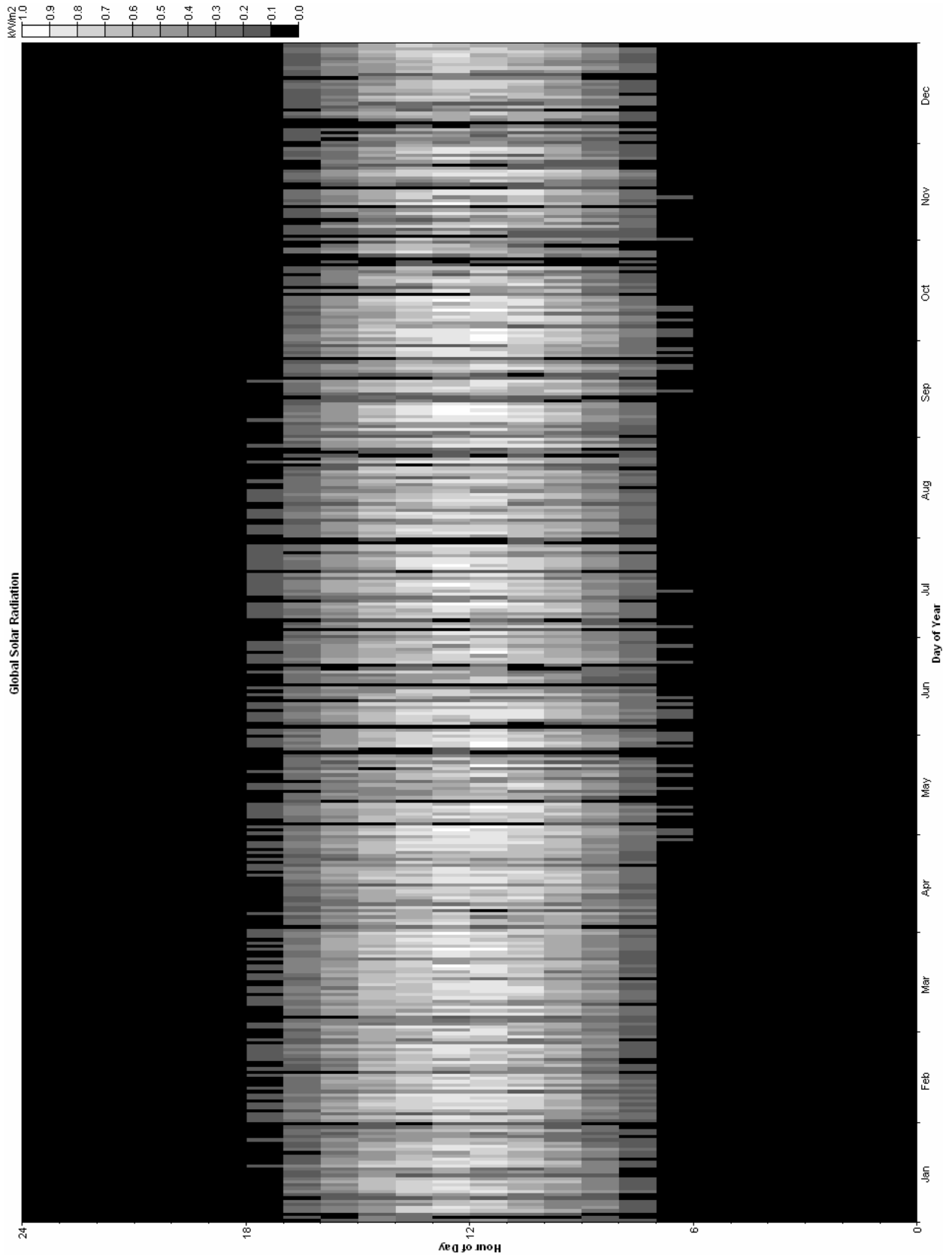

Solar Resource for Sri Lanka

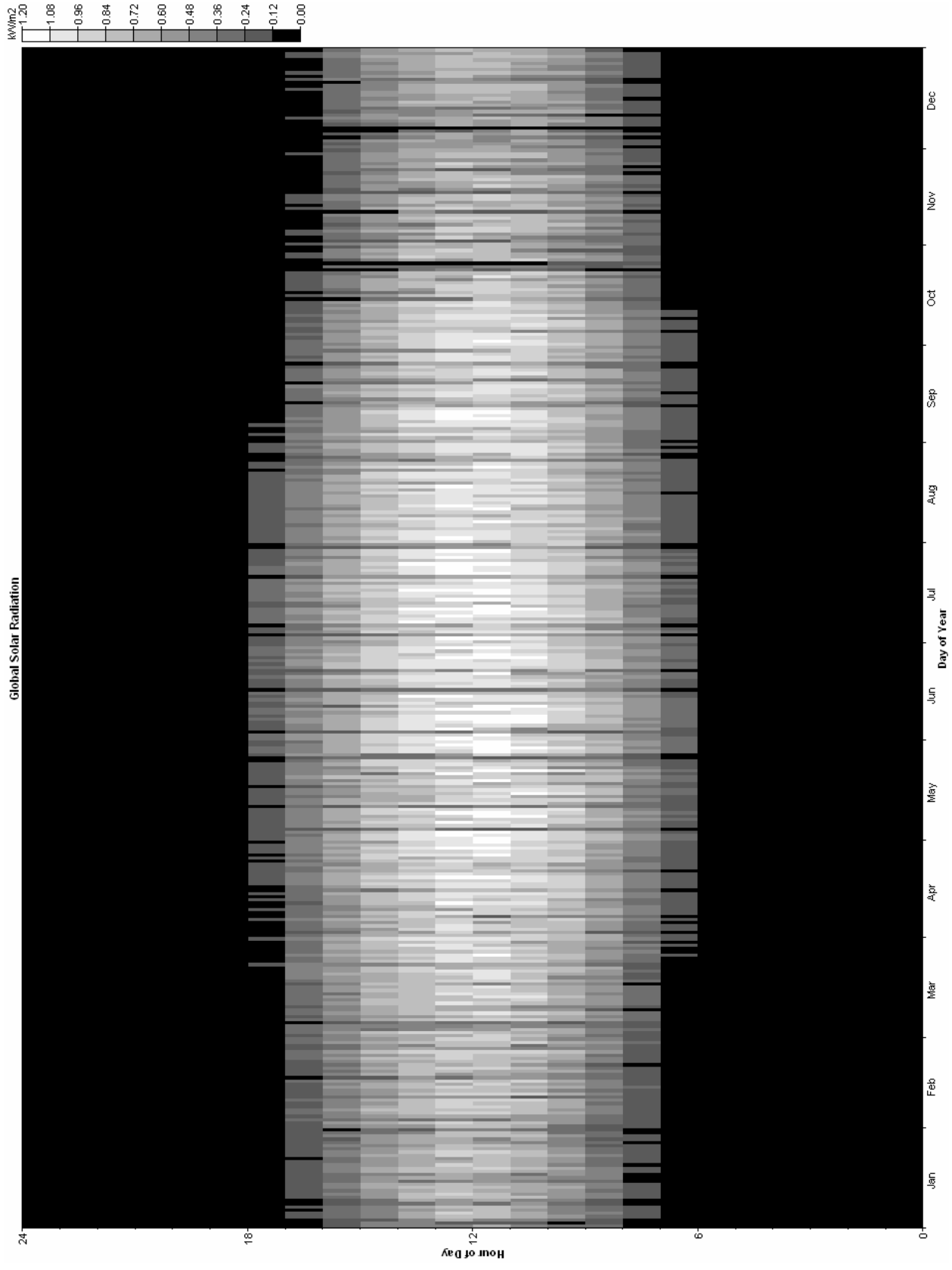

Solar Resource for Southern Egypt

Appendix C: Cost of Energy vs. Load Graphs

These graphs, similar to those shown in Figure 4, plot data points for two additional cases: a lower solar resource (Northern India) with a low diesel price (\$0.30/liter) and an increased solar resource (Southern Egypt) with a high diesel price (\$0.80/liter).

India solar resource
Fuel Price: \$0.30/liter

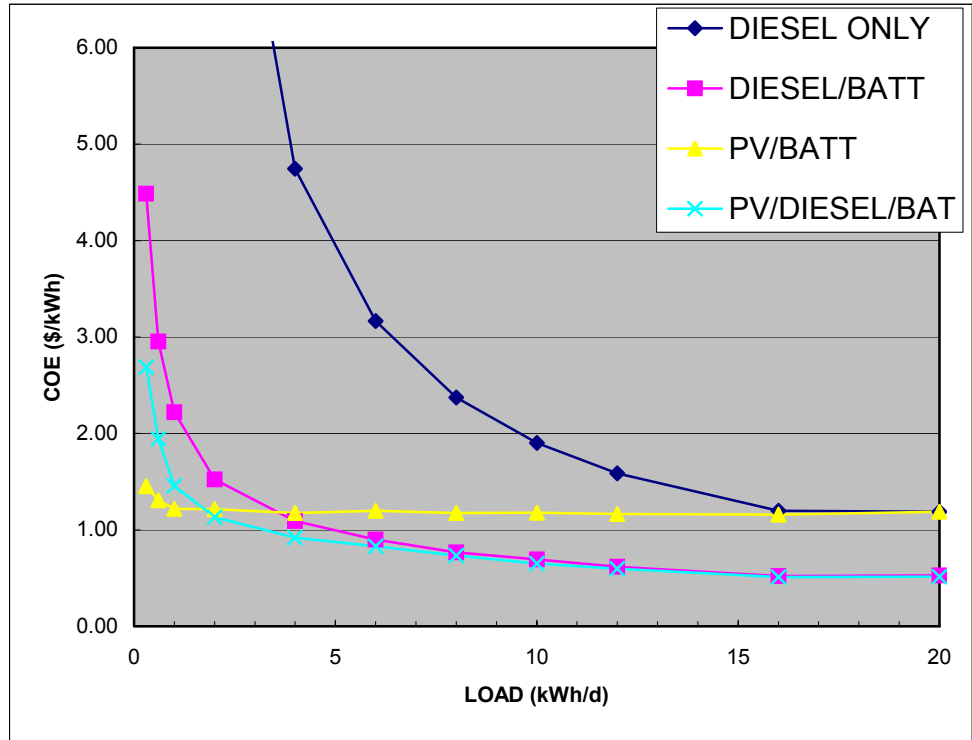

Egypt solar resource
Fuel Price: \$0.80/liter

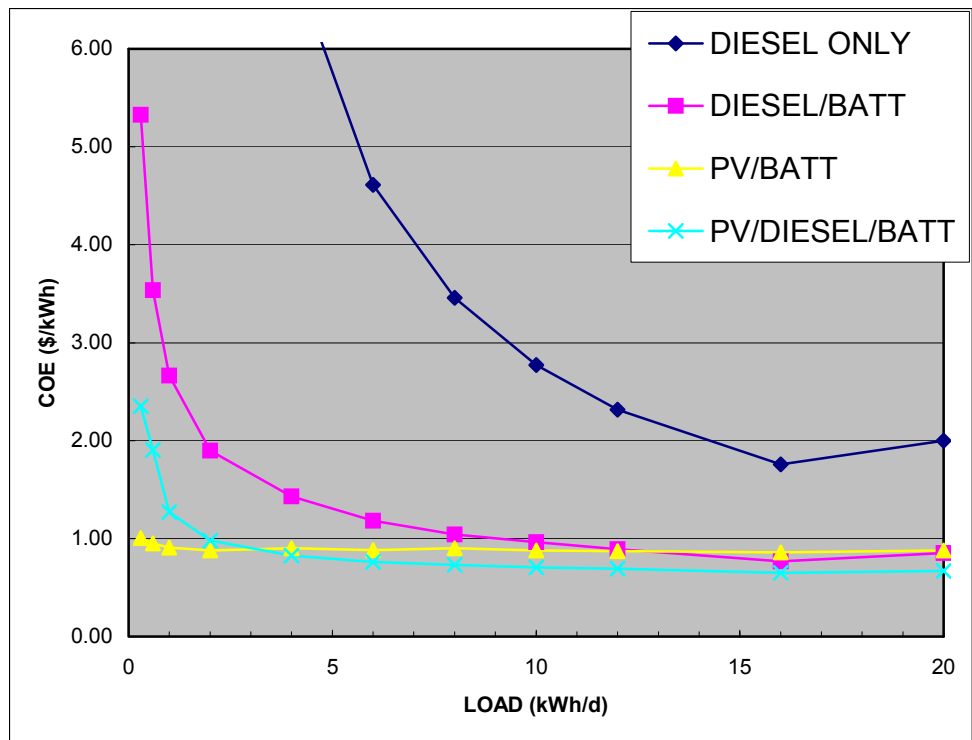

Appendix D: OST Graphs Showing Maximum Annual Capacity Shortage vs. Load

Figure 7 illustrates the optimal system type when comparing the maximum annual capacity shortage with the system load. The two graphs show this data for two extreme fuel prices of \$0.30/liter and \$0.80/liter. This appendix expands the data shown in Figure 7 with additional graphs for diesel prices of \$0.40, \$0.50, \$0.60, and \$0.70 per liter. With each successive increase in fuel price, the PV/battery system becomes more cost competitive with the hybrid PV/diesel/battery system.

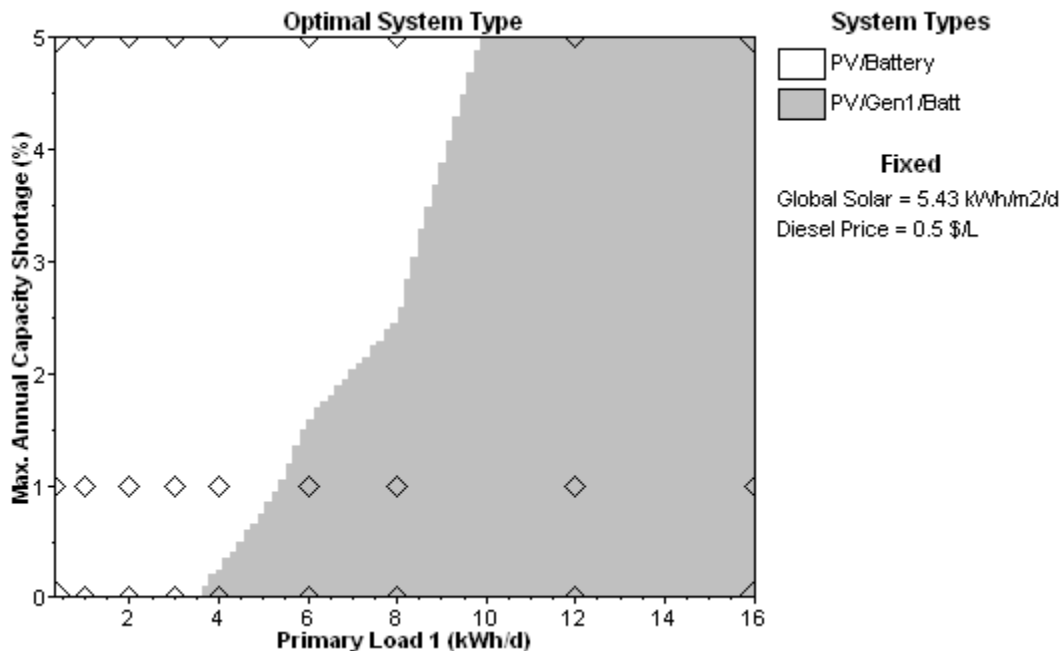
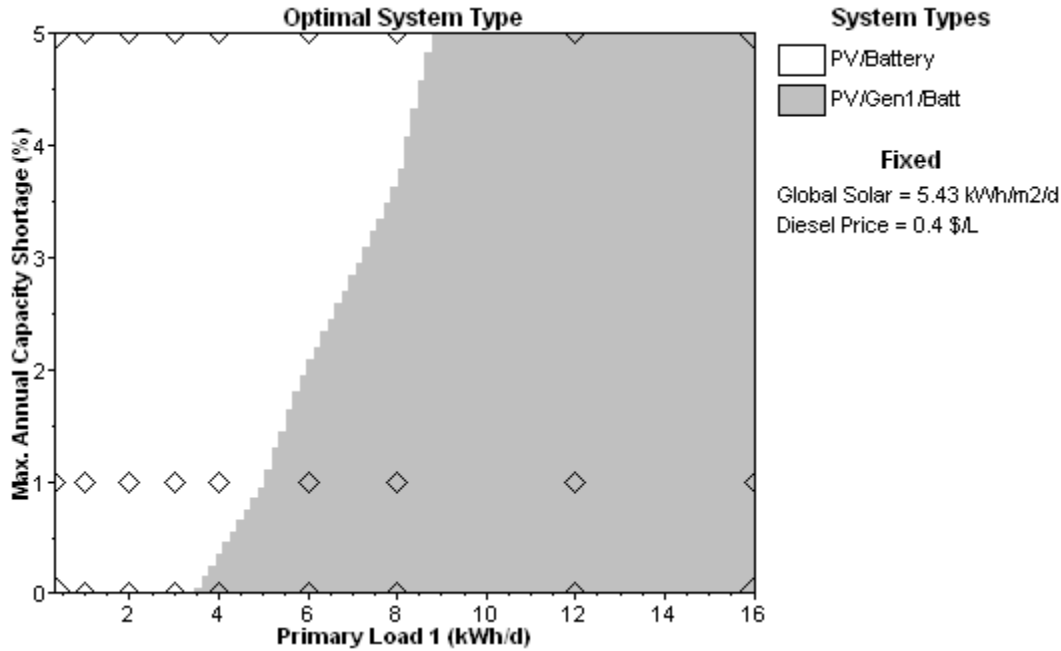

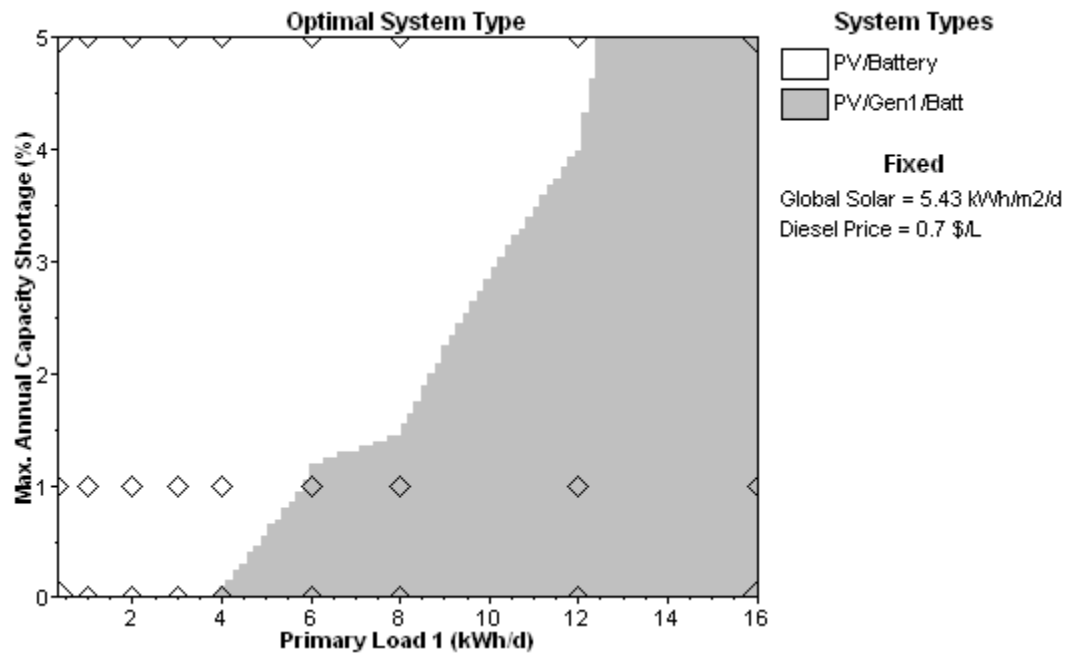
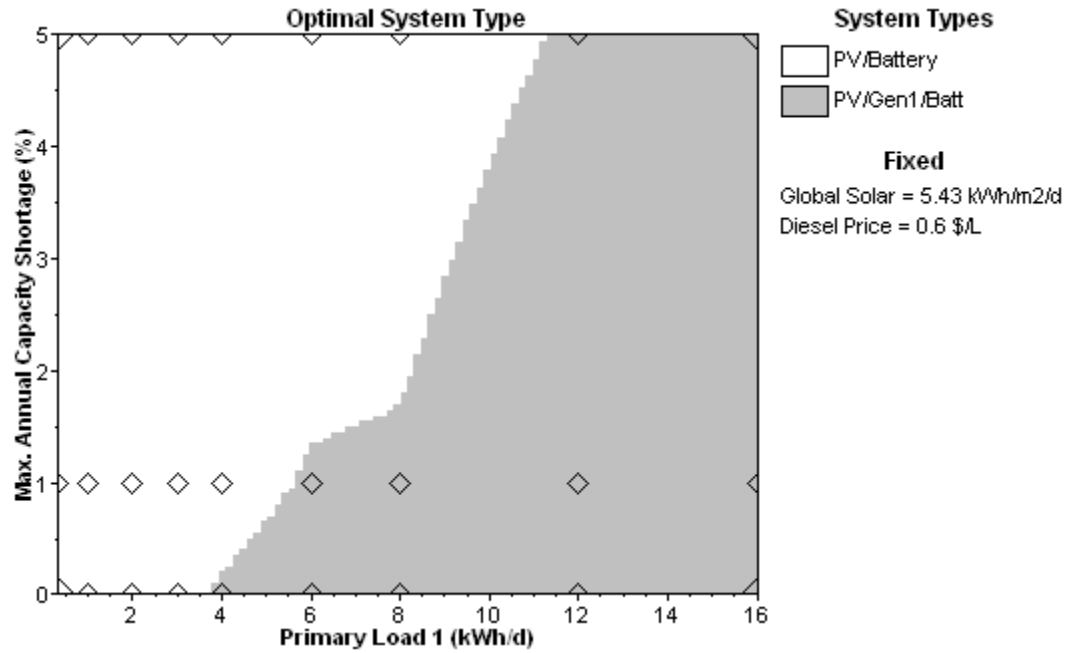

Appendix E: Hourly Load and Production Profiles

The following graphs show the hourly load and electrical production of the system for two different days of the year. For Sri Lanka, March has the highest average solar radiation and December has the lowest average. For March 15, the PV array can meet the entire load during the day with enough energy stored in the battery bank to meet the nighttime load. On December 15, the generator runs for one hour in the morning and charges the batteries to assist the PV array.

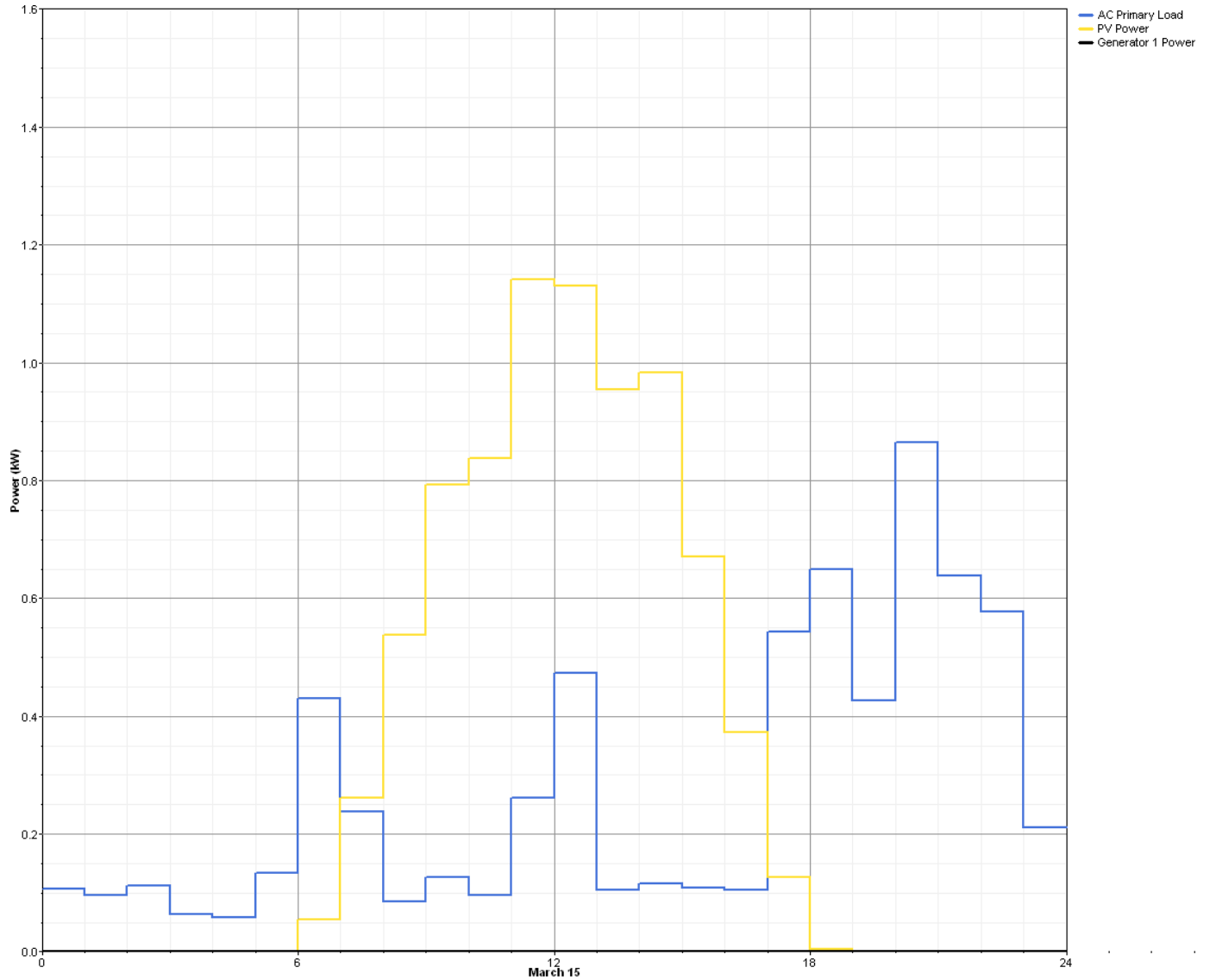

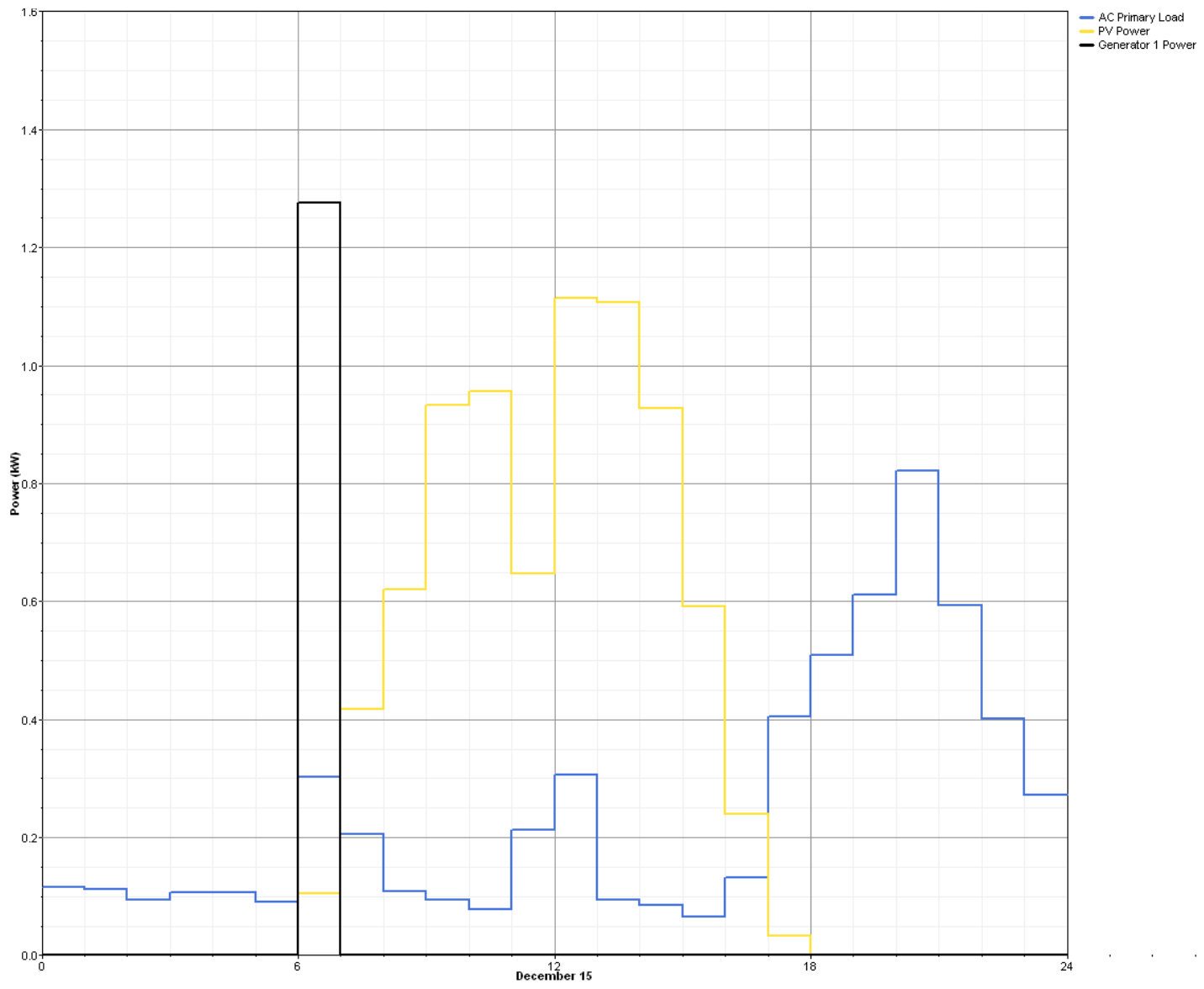

Appendix F: Total Electrical Output and Generator Output vs. Load Graphs

The renewable energy fraction of the optimal system can also be shown in graphs comparing the total electrical output and the generator output. By graphing these two values simultaneously, the difference between the curves represents the amount of the electrical production made up of renewables. In reading these graphs, note that the y-axis scales are not the same.

The first of these graphs plots data for a diesel price of \$0.30/liter. Up to a load 3kWh/d, the generator is not used at all. The optimal system uses only PV to produce the total electrical output. After 3kWh/d, the generator begins to make up a portion of the total output. By 16kWh/d, the renewable fraction is very small and the generator provides almost all of the electrical output.

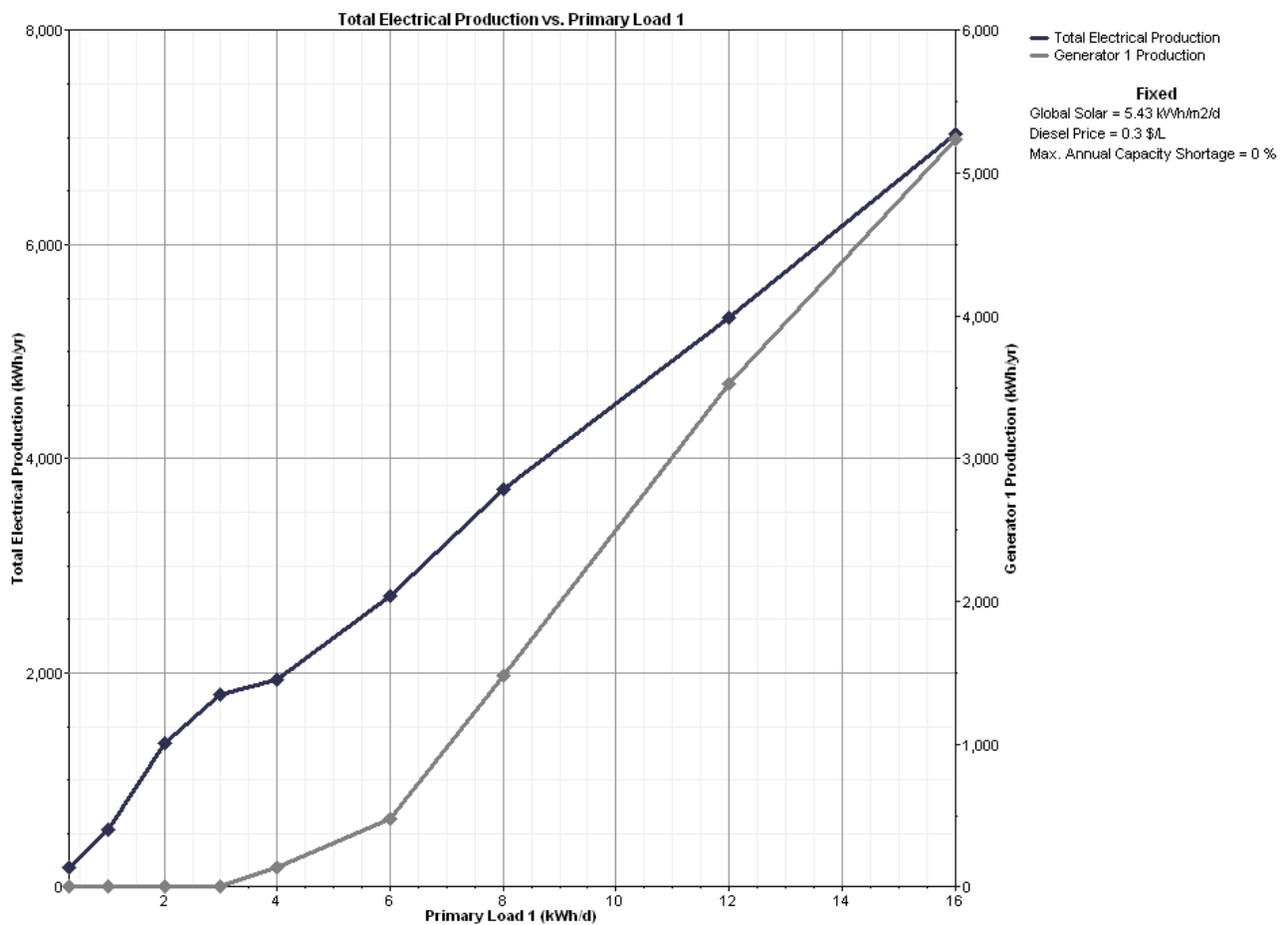

The second graph plots data for \$0.50/liter. The two curves are similar to those in the first graph except that the difference between them has increased. As the price of diesel has increased, the renewable fraction of the optimal system has also increased.

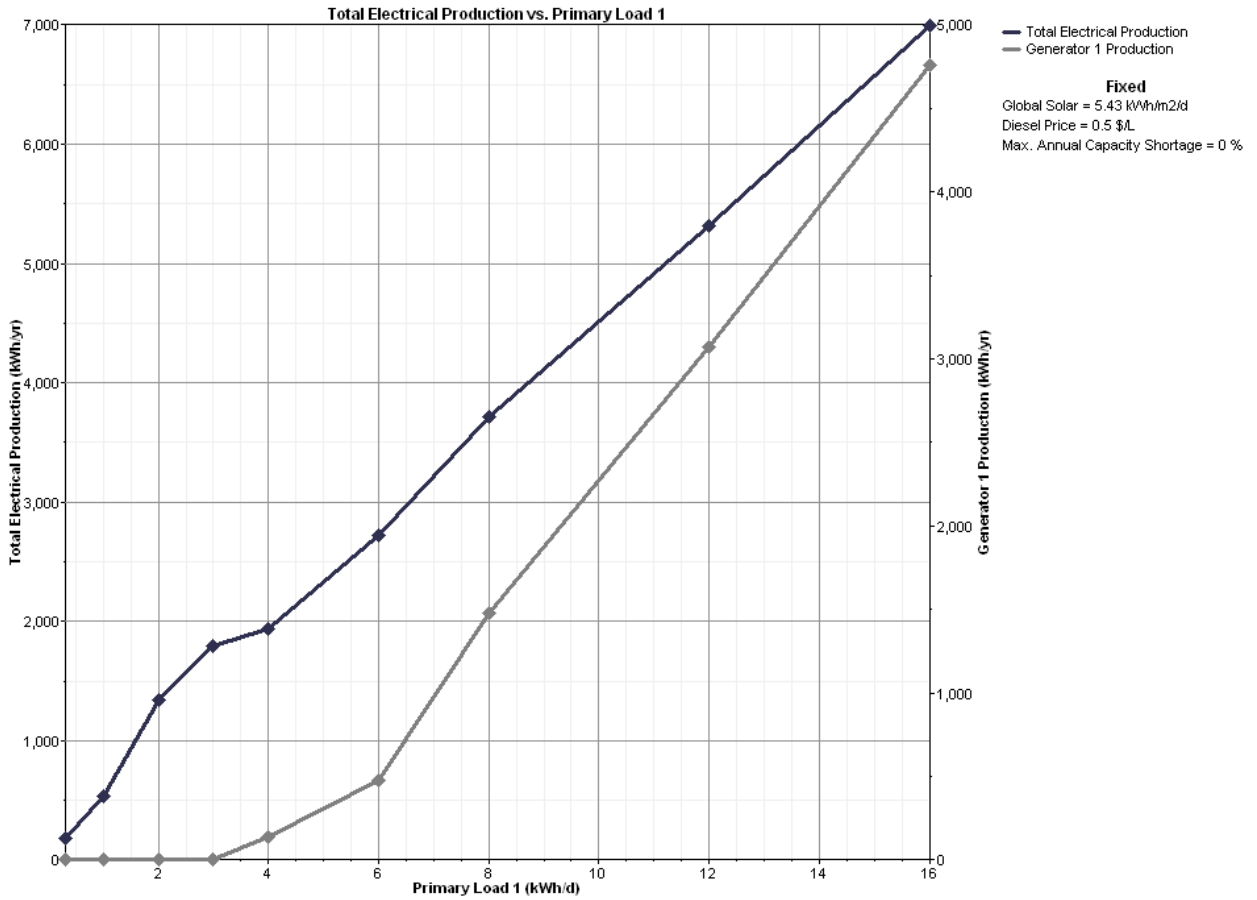

The third graph, representing a fuel price of \$0.80/liter, illustrates an even greater difference between the two curves.

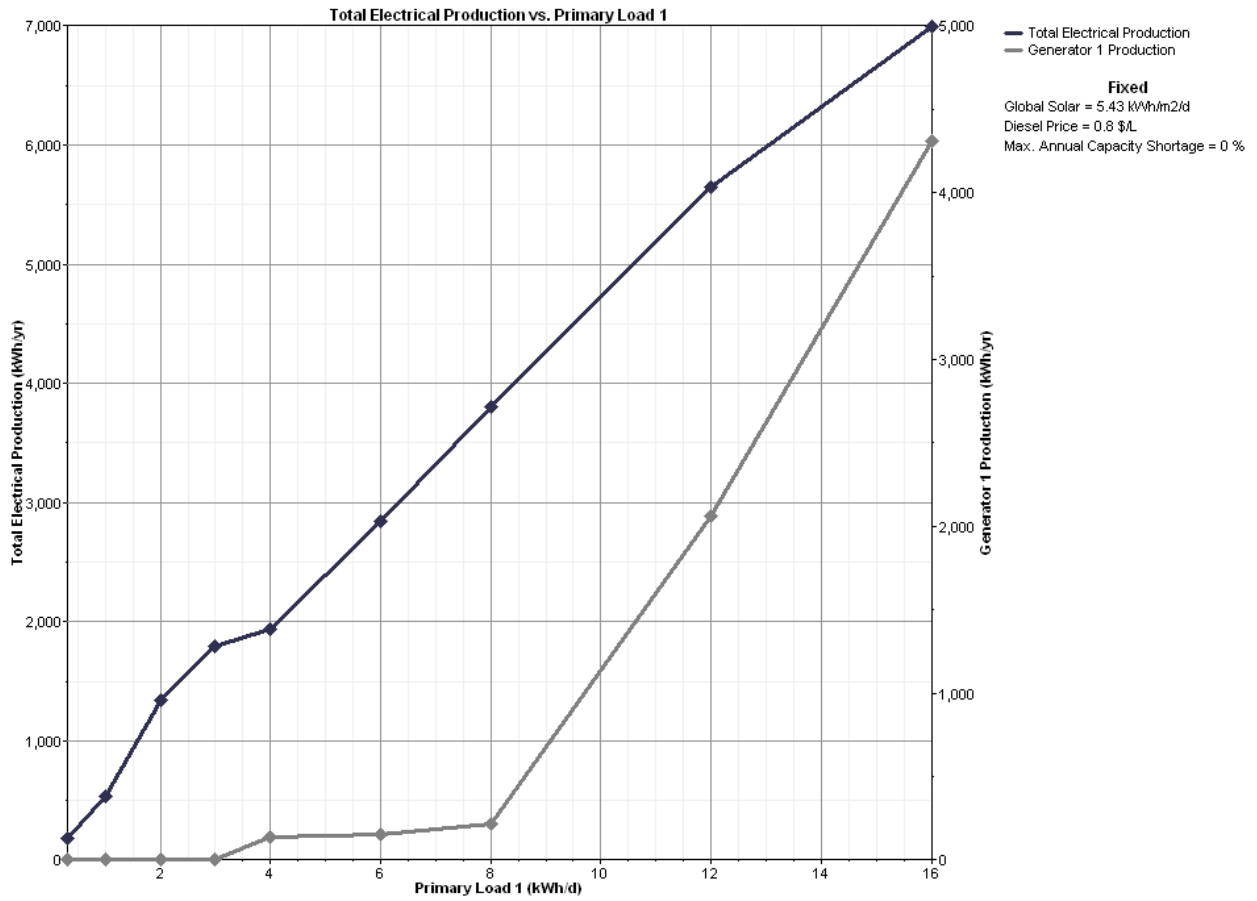

REPORT DOCUMENTATION PAGE

Form Approved
OMB No. 0704-0188

The public reporting burden for this collection of information is estimated to average 1 hour per response, including the time for reviewing instructions, searching existing data sources, gathering and maintaining the data needed, and completing and reviewing the collection of information. Send comments regarding this burden estimate or any other aspect of this collection of information, including suggestions for reducing the burden, to Department of Defense, Executive Services and Communications Directorate (0704-0188). Respondents should be aware that notwithstanding any other provision of law, no person shall be subject to any penalty for failing to comply with a collection of information if it does not display a currently valid OMB control number.

PLEASE DO NOT RETURN YOUR FORM TO THE ABOVE ORGANIZATION.

1. REPORT DATE (DD-MM-YYYY) May 2005		2. REPORT TYPE Technical Report		3. DATES COVERED (From - To)		
4. TITLE AND SUBTITLE Using HOMER Software, NREL's Micropower Optimization Model, to Explore the Role of Gen-sets in Small Solar Power Systems; Case Study: Sri Lanka			5a. CONTRACT NUMBER DE-AC36-99-GO10337			
			5b. GRANT NUMBER			
			5c. PROGRAM ELEMENT NUMBER			
6. AUTHOR(S) T. Givler and P. Lilienthal			5d. PROJECT NUMBER NREL/TP-710-36774			
			5e. TASK NUMBER PVP4.9001			
			5f. WORK UNIT NUMBER			
7. PERFORMING ORGANIZATION NAME(S) AND ADDRESS(ES) National Renewable Energy Laboratory 1617 Cole Blvd. Golden, CO 80401-3393				8. PERFORMING ORGANIZATION REPORT NUMBER NREL/TP-710-36774		
9. SPONSORING/MONITORING AGENCY NAME(S) AND ADDRESS(ES)				10. SPONSOR/MONITOR'S ACRONYM(S) NREL		
				11. SPONSORING/MONITORING AGENCY REPORT NUMBER		
12. DISTRIBUTION AVAILABILITY STATEMENT National Technical Information Service U.S. Department of Commerce 5285 Port Royal Road Springfield, VA 22161						
13. SUPPLEMENTARY NOTES						
14. ABSTRACT (Maximum 200 Words) The HOMER software, NREL's micropower optimization model, can evaluate a range of equipment options over varying constraints and sensitivities to optimize small power systems. HOMER's flexibility makes it useful in the evaluation of design issues in the planning and early decision-making phase of rural electrification projects. This paper discusses using HOMER to explore the role of gen-sets in small solar power systems in Sri Lanka.						
15. SUBJECT TERMS HOMER; the HOMER software; micropower optimization model; Sri Lanka; gen-sets; solar home systems; photovoltaic (PV) systems; diesel hybrid system						
16. SECURITY CLASSIFICATION OF:			17. LIMITATION OF ABSTRACT UL	18. NUMBER OF PAGES	19a. NAME OF RESPONSIBLE PERSON	
a. REPORT Unclassified	b. ABSTRACT Unclassified	c. THIS PAGE Unclassified			19b. TELEPHONE NUMBER (Include area code)	

Standard Form 298 (Rev. 8/98)
Prescribed by ANSI Std. Z39.18