

Lawrence Berkeley National Laboratory

Recent Work

Title

VELOCITY MODULATION INFRARED LASER SPECTROSCOPY OF MOLECULAR IONS

Permalink

<https://escholarship.org/uc/item/9pd5p4wp>

Authors

Gudeman, C.S.

Saykally, R.J.

Publication Date

1984



Lawrence Berkeley Laboratory

UNIVERSITY OF CALIFORNIA

Materials & Molecular Research Division

RECEIVED
LAWRENCE
BERKELEY LABORATORY
APR 17 1984
LIBRARY AND
DOCUMENTS SECTION

Submitted to Annual Reviews of Physical Chemistry

VELOCITY MODULATION INFRARED LASER SPECTROSCOPY
OF MOLECULAR IONS

C.S. Gudeman and R.J. Saykally

January 1984

TWO-WEEK LOAN COPY
*This is a Library Circulating Copy
which may be borrowed for two weeks.
For a personal retention copy, call
Tech. Info. Division, Ext. 6782.*

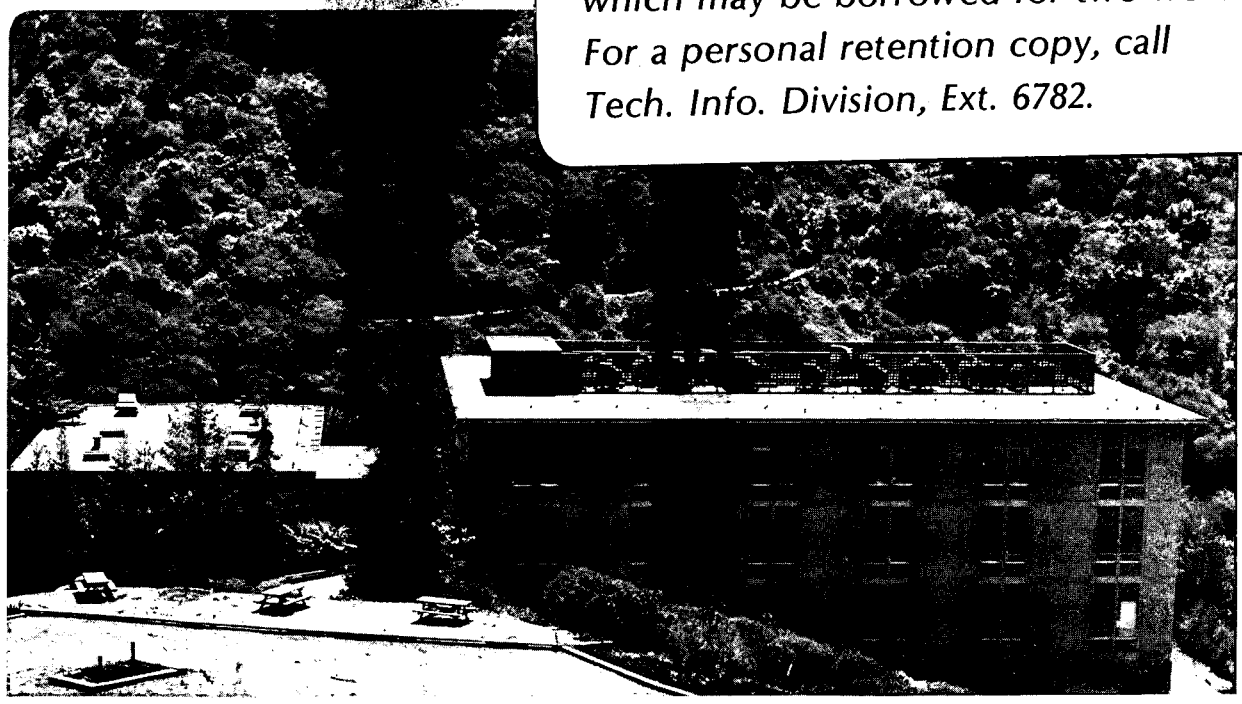

LBL-17327
c.2

DISCLAIMER

This document was prepared as an account of work sponsored by the United States Government. While this document is believed to contain correct information, neither the United States Government nor any agency thereof, nor the Regents of the University of California, nor any of their employees, makes any warranty, express or implied, or assumes any legal responsibility for the accuracy, completeness, or usefulness of any information, apparatus, product, or process disclosed, or represents that its use would not infringe privately owned rights. Reference herein to any specific commercial product, process, or service by its trade name, trademark, manufacturer, or otherwise, does not necessarily constitute or imply its endorsement, recommendation, or favoring by the United States Government or any agency thereof, or the Regents of the University of California. The views and opinions of authors expressed herein do not necessarily state or reflect those of the United States Government or any agency thereof or the Regents of the University of California.

VELOCITY MODULATION INFRARED LASER SPECTROSCOPY OF MOLECULAR IONS

Christopher S. Gudeman and Richard J. Saykally

Department of Chemistry, Materials and Molecular Research Division
Lawrence Berkeley Laboratory, University of California, Berkeley, CA 94720
(415) 642-8269

Submitted to: Annual Reviews of
Physical Chemistry
Vol. 35, 1984

VELOCITY MODULATION INFRARED LASER SPECTROSCOPY OF MOLECULAR IONS

The field of molecular ion spectroscopy is presently an area of remarkable vitality, in which important discoveries that affect many diverse subfields of science are being made at a truly impressive rate. Even the most current reviews of this subject (1-4), written as recently as mid-1983, are already obsolete. Exciting new technological progress, particularly, the advent of tunable narrowband lasers, the rapid evolution of quantum optics, and the microelectronics revolution, have provided the foundation for the development of new spectroscopic techniques with the inherent capability to study charged molecules - long regarded as the ultimate challenge to the spectroscopist.

Concurrent developments in other areas of science and technology, most notably, the astronomical investigation of interstellar dust clouds and the pervasive industrial utilization of reactive, low density plasmas, have spawned a widespread interest in the structures, properties, and dynamics of molecular ions. While even as late as 1974 only one ion (H_2^+) had been studied at a level of resolution transcending the optical Doppler limit, now over 25 charged molecules have been investigated by a wide variety of high resolution techniques, including microwave spectroscopy, laser magnetic resonance, laser spectroscopy of fast ion beams, laser induced fluorescence, Fourier transform infrared spectroscopy, and tunable infrared laser spectroscopy, employing difference frequency sources, diode lasers, and color center lasers. In this article we review the spectroscopic studies of gaseous molecular ions made with infrared techniques; it is this area in which we have witnessed the most dramatic evolution within the past year, principally because of the development of a general new approach to molecular ion spectroscopy - the velocity

modulation laser absorption technique. We first present a general chronology of infrared spectroscopy of ions, then describe the development of velocity modulation spectroscopy and discuss the theoretical concepts upon which it is based.

INFRARED STUDIES OF $H_3O^+ \cdot nH_2O$ and $NH_4^+ \cdot nNH_3$ GENERATED BY PULSED RADIOLYSIS

While low resolution infrared spectroscopy has been used extensively to study molecular ions in salts, liquids, and in cryogenic matrices (5), it was not until the important work of Schwartz (6) in 1977 that such experiments were carried out in the gas phase. (Ignoring the observation of vibration-rotation emission spectra of NO^+ observed during atmospheric nuclear weapons testing!)(7). In these pulsed radiolysis experiments, a beam of electrons from a van de Graaf generator was used to ionize a sample of argon gas, kept near atmospheric pressure, and containing a variable amount of water vapor. The ions formed ($H_3O^+ \cdot nH_2O$ with $n = 0-6$) in this manner were measured at low resolution by infrared absorption spectroscopy, using a conventional glowbar source and signal averaging techniques.

The ionizing electron beam consisted of 2.1 MeV pulses, 2-10 μ sec in duration and repeated 100-200 times per second, yielding an average beam current of 80 mA. The electron beam was directed into a steel 15 x 60 cm reaction cell in which a series of multipass mirrors were mounted in a White cell configuration. The infrared radiation from a glowbar operating near 1450°C made 40 traversals of the cell, corresponding to an optical path of 20 m, before entering a monochromator with a resolution near 40 cm^{-1} , and finally impinging on an InSb photoconductor detector. The output of the detector was amplified, analyzed by a waveform recorder, and signal averaged; approximately 10^4 individual pulses were averaged at

each monochromator setting to produce a spectrum. Dried argon was flowed through the sample cell at atmospheric pressure from two different paths, one proceeding directly to the cell, and the other being saturated with water before merging with the first. Adjustment of the relative flow rates controlled the total amount of water in the cell. Infrared spectra of the H_3O^+ ion and its various hydrates were obtained over the range from 2000 to 4000 cm^{-1} in this manner.

While the spectroscopic information derived from this experiment was not sufficiently precise to afford a definitive determination of the structures of the oxonium hydrates, it did serve to corroborate previous condensed phase data, and hence yielded measurements of vibrational transition frequencies for H_3O^+ ($\nu_3 = 3490\text{ cm}^{-1}$), H_2O^+ ($\nu_3 = 3290\text{ cm}^{-1}$), H_5O_2^+ (3170 cm^{-1}), H_9O_4^+ (2660 cm^{-1} , 3000 cm^{-1}), and for the slightly perturbed water molecules in the higher hydrates H_7O_3^+ , H_9O_4^+ , etc. (3620 cm^{-1} and 3710 cm^{-1}), all of which are free from the obfuscations resulting from solvent or matrix interactions associated with condensed phase spectra (although even Schwartz's assignments of some transitions are questionable). Furthermore, the spectroscopic evidence indicates that the structure of the hydrated proton should be considered to be an H_3O^+ entity with various numbers of water molecules hydrogen-bonded to the hydrogens. The fact that two fundamental bands are observed for H_9O_4^+ (excepting the H_2O stretches) implies that the symmetry of this species, the first solvation sphere of the proton, is C_{3v} , not D_{3h} .

In 1980 these measurements were extended to the series of solvated ammonium ions ($\text{NH}_4^+ \cdot n\text{NH}_3$, $n = 0-4$), in which fundamental vibrational frequencies were again obtained for some of these important species (NH_4^+ : $\nu_3 = 3335\text{ cm}^{-1}$, $\text{NH}_4^+ \cdot 4\text{NH}_3$: $\nu_3 = 2867\text{ cm}^{-1}$, $\text{NH}_4^+ \cdot 4\text{NH}_3$: 2682 cm^{-1} ,

3365 cm^{-1} , 2790 cm^{-1}). These experiments, both on the oxonium and ammonium systems, represent an important achievement in ion spectroscopy, not only because they involved the first infrared measurements on gaseous molecular ions, but because they provided a degree of insight and guidance regarding the subjects of ion solvation and proton transfer - central questions in important areas of chemistry and biology.

INFRARED LASER SPECTROSCOPY OF FAST ION BEAMS

Although mass-selected ion beam techniques have been employed for various purposes in atomic and molecular physics for several decades, the first use of an ion beam for measurement of the vibration-rotation spectrum of a molecular ion was made in the pioneering work of Wing and co-workers (8) on HD^+ (1976).

In this experiment a fast (1-10 KeV) ion beam of HD^+ ions was crossed at a small angle with the beam from a line-tunable cw CO laser (5.3-6.0 μm), and the Doppler shift resulting from the fast ion motion in the lab frame was used to shift vibration-rotation transitions into coincidence with the laser frequency. The effect of laser excitation on the rate of charge transfer between the fast ions and a static buffer gas was used as an indirect means of detecting the transitions. (Typically the charge transfer cross section varies by a few percent with a unit change in vibrational quantum number of light ions, like HD^+ , HeH^+ , etc.). The spectral resolution in these measurements was sufficiently high ($\sim 10^{-7}$) to reveal the hyperfine splittings in HD^+ . Subsequently, several other fundamental molecular ions (HeH^+ (9), D_3^+ (10), H_2D^+ (11)) have been investigated by Wing and co-workers (12) with this technique, and the extension to the vibration-rotation spectra of HeD^+ and HD_2^+ and to more V. J states in HD^+ has been made, although the analysis of these latter spectra have not

yet been completed (13). The combination of mass selectivity and kinematic compression of the translational energy distributions inherent in this approach to high resolution spectroscopy have made fast ion beams spectroscopy one of the principal techniques for studying molecular ions -- in the visible as well as in the infrared (1-4).

Carrington and his co-workers at Southampton have taken advantage of the unusually high degree of vibrational excitation observed for simple ions in low pressure ion sources to study vibration-rotation spectra of several important molecular ions in rovibrational states near their respective dissociation limits. In their experiments a mass selected and velocity-tuned ion beam, extracted from an electron impact or plasma ion source, was merged with the output of one or two cw CO₂ lasers, and transitions were induced from bound vibrational levels near the dissociation limit into either a repulsive electronic state, as in the case of HD⁺, or into predissociating bound or quasibound levels above the dissociation limit. Again these spectra were detected indirectly; in this case, a dissociation fragment was monitored by a mass-selective detection system. By employing two CO₂ lasers in a double resonance configuration, high resolution vibration-rotation spectra could be obtained in the former case, whereas this was only necessary in the latter situation when the predissociating levels had a very short lifetime ($\leq 10^{-9}$ sec). Carrington and co-workers have utilized this fast ion beam photofragmentation apparatus to measure very extensive vibration-rotation spectra of HD⁺ (14-16), HeH⁺ (all 4 isotopes!) (17,18), CH⁺ (19), and H₃⁺ (H₂D⁺, HD₂⁺, D₃⁺) (20-23) near their dissociation limits. A thorough review of fast ion beam laser spectroscopy has been published recently by Carrington and Softley (24). In this paper we describe only the very latest developments in this field.

Carrington and Kennedy (23) have reported the results of an extensive study of the infrared predissociation spectrum of H_3^+ . In this landmark work, fast ion beam spectroscopy was used in conjunction with photofragment detection to measure nearly 27,000 vibration-rotation transitions in H_3^+ lying near or above the lowest dissociation limit ($\text{H}_3^+ \rightarrow \text{H}_2(v=0, J=0) + \text{H}^+$).

The H_3^+ ions were generated in an electron bombardment source at H_2 pressures near 10^{-3} torr, then accelerated, focussed, and mass selected as in the earlier studies. The velocity-tuned ion beam intersected collinearly with the beam from a cw- CO_2 laser in the ion drift tube. Upon emerging from the drift tube, the ion beam entered an electrostatic energy analyzer, in which a given ion was mass selected and its kinetic energy determined. The vibration-rotation spectrum of H_3^+ was measured by monitoring the H^+ fragment produced when photodissociation was induced by a given CO_2 laser line. The spectral region from 872.120 to 1018.278 cm^{-1} was recorded nearly continuously in this fashion. Kinematic compression reduced the Doppler widths of H_3^+ transitions to ~ 3 MHz, but in most cases, linewidths were determined by the predissociation linewidth, which varied from 3 to 60 MHz for the spectra recorded. States predissociating at a faster rate were not detectable by the ion beam velocity modulation scheme employed for subtraction of background ions produced from collision-induced ionization and nonresonant photoionization processes.

The predissociation lifetimes of both initial and final (laser excited) states of H_3^+ were constrained by the geometry of the apparatus and the ion beam velocity to the values: $\tau_{\text{initial}} \geq 3 \mu\text{sec}$, $\tau_{\text{final}} \leq 0.7 \mu\text{sec}$. Measurement of the kinetic energy of the H^+ photofragments allowed a determination of the energy difference between the predissociating state of H_3^+ and its appropriate $\text{H}_2 + \text{H}^+$ dissociation limit (no evidence of the more energetic $\text{H}_3^+ \rightarrow \text{H}_2^+ + \text{H}$ channel was observed in this work). The observation

of large proton kinetic energy releases, over 3000 cm^{-1} in many cases, coupled with the fact that the exciting laser energy was between 870 and 1090 cm^{-1} , forced the authors to conclude that a very large portion of the lines observed in the infrared predissociation spectrum of H_3^+ must arise from transitions in which both the upper and lower (and necessarily metastable) levels of the ion lie well above the lowest dissociation limit.

Because this 27,000 line spectrum was far too complex to permit a detailed assignment, the authors synthesized a low resolution photodissociation spectrum by convolution of the 1934 strongest lines in the spectrum with a Gaussian linewidth function, in hopes of revealing the large scale features of the spectrum. The striking result obtained from this procedure was that four relatively sharp maxima were produced in the convolution, and that the frequencies of these four maxima were in remarkable agreement with the $J = 3 \rightarrow 5$ rotational transitions of H_2 in its $v = 0, 1, 2,$ and 3 vibrational states. This suggests that the highly excited H_3^+ ions are best thought of as $\text{H}_2 \dots \text{H}^+$ complexes, in which the vibrational and rotational quantum numbers of the H_2 entity are essentially conserved.

In order to obtain a qualitative understanding of the origin of these predissociation spectra, a model analogous to those used in studies of van der Waals complexes was adopted, in which H_3^+ is thought of as a weakly interacting H_2 and a proton. The H_3^+ potential surface of Giese and Gentry (25) was used as the basis of this model. This potential surface is a sum over diatomic potential functions in which the widths, depths, and minimum positions are allowed to vary from the values for H_2 as the perturbing H^+ approaches. The interaction energy of H^+ with specific v, J states of H_2 was computed and reexpressed as a Legendre expansion, as in recent treatment of van der Waals molecules.

Vibration-rotation levels of $H_2 \dots H^+$ were then calculated in an appropriate basis set according to the procedure of LeRoy and Liu (26). A histogram of the density of states from 500 cm^{-1} above the dissociation limit to 1000 cm^{-1} below it were calculated. This clearly indicated that transitions involving $J = 3 \rightarrow 5$ transitions of the H_2 entity do indeed show clustering about the unperturbed H_2 frequency. Moreover, the density of states in this region was found to be very high, with about 4000 rovibrational levels arising from $H^+ \dots H_2(v=2, J=5)$ alone, and nearly 60 different $H^+ \dots H_2(v, J)$ dissociation limits lying within the first 2 eV above the lowest ($v=0, J=0$) dissociation limit. In spite of the semiquantitative nature of this model, resulting principally from the lack of detailed knowledge regarding the nature of the predissociation processes responsible for the H_3^+ spectrum, this formalism does reproduce the two most salient features of the H_3^+ predissociation spectrum...a very large level density (27,000 transitions in 222 cm^{-1} !) near the lowest dissociation limit and clustering of the H_3^+ transitions at frequencies near those of the $J = 3 \rightarrow 5$ transitions in unperturbed H_2 molecules.

Preliminary measurements of predissociation spectra were made for other isotopic forms of H_3^+ , viz. H_2D^+ , HD_2^+ , and D_3^+ . The results of these experiments further substantiated the general trends noted above. In addition, very interesting isotope effects on the predissociation process were noted; for both H_2D^+ and HD_2^+ only H^+ photofragments were observed; when the electrostatic analyzer was tuned to transmit D^+ ions, no photofragment spectrum was detected. These observations again reinforce the need for theoretical developments of the photofragmentation process for H_3^+ .

The exciting results obtained by Carrington and Kennedy (23) represent one of the most important achievements made in recent years with regard to understanding the structures and dynamics of molecules near dissociation. It is a beautiful example of how a high resolution spectroscopic technique can bridge the gap between "conventional" spectroscopy of molecules in quasi-equilibrium configurations and the powerful methods of modern reaction dynamics. The spectra observed for H_3^+ near its dissociation limit can be regarded as a detailed characterization of what molecular dynamicists term "shape resonances" and "Feshbach resonances". When answers to some of the important questions posed by this work, regarding processes leading to the formation of ions near or above their dissociation limits, the mechanisms of predissociation of such states, and theoretical description of the eigenstates of molecules in such states, are eventually obtained, our knowledge of molecules and the interactions between them will have made a true "quantum leap"!

SPECTROSCOPY OF DC DISCHARGES WITH TUNABLE INFRARED LASERS

One of the most dramatic steps in molecular ion spectroscopy occurred in 1974, when Dixon and Woods (27) observed the microwave spectrum of CO^+ in a laboratory DC glow discharge; this work was soon followed by the measurement of microwave spectra of HCO^+ (28), HNN^+ (29), and their isotopic variants in similar discharges, thus indicating the promise of using low density plasmas as sources of molecular ions (and indeed, of excited species in general) for study by high resolution absorption spectroscopy.

In 1975, Oka initiated an ambitious project to observe the high resolution vibration-rotation spectrum of H_3^+ in a similar DC plasma by multi-

passing the output from a laser difference frequency infrared source through a long (2 meter) discharge cell. This monumental achievement in spectroscopy was indeed realized, but only after 5 years of grueling effort! In 1980, the infrared spectrum of H_3^+ was observed for the first time (30a). Subsequently, Oka's apparatus at the Herzberg Institute was used to study vibration-rotation spectra of HeH^+ (Bernath and Amano) (31) and NeH^+ (Wong, Bernath, and Amano) (32) as described in earlier reviews (1-3, 24).

Davies and co-workers have employed a diode laser for the study of ions generated in a DC discharge. Davies and Hamilton (33) reported observing the $^2P_{1/2} - ^2P_{3/2}$ infrared fine structure transition ($1431.644(1) \text{ cm}^{-1}$) in the ground ($3p^5$) state of $^{40}\text{Ar}^+$ by direct absorption in a multi-passed 3 meter long discharge. The isotope shift for $^{36}\text{Ar}^+$ was measured to be $3 \times 10^{-3} \text{ cm}^{-1}$. It is interesting to note that a weak magnetic dipole transition could be observed in this manner, although the much smaller partition function of an atomic ion in a plasma largely compensates for the reduced transition moment. Davies, Hamilton, Lewis-Began, and Okamura (34) have also reported a measurement of the R(8.5) transition of $\text{HCl}^+(X^2\Pi_{3/2})$ in a DC discharge, although no further details have been given.

The principal limitation in simply utilizing a discharge as a general source of molecular ions was demonstrated in a recent study by Amano and co-workers with the difference frequency apparatus at the Herzberg Institute. In their study of the infrared spectrum of the NH_2 radical, Amano, Bernath and McKellar (35) present absorption spectra obtained in a NH_3 discharge near 3250 cm^{-1} . Strong lines from ammonia are observed, both with the discharge on and off, in addition to numerous overlapping transitions that are present only with the discharge turned on. The

authors employ Zeeman modulation to discriminate against transitions arising from diamagnetic species, and thus obtain a beautiful infrared spectrum of NH_2 , relatively free from interfering lines. However, the difficulty involved with studying diamagnetic molecules in such a chemically complicated discharge is clear -- their spectra are often buried by transitions from the more abundant precursor, and the large number of lines arising from the many species present in a discharge through, for example, ammonia (NH_3 , NH_2 , NH , etc. in electronically and vibrationally excited states, as well as in their ground states) makes assignments and identifications a perilous task. This problem is greatly exacerbated for the case of molecular ions, which are usually $10^4 - 10^6$ times less abundant than the major neutral species in such plasmas.

FOURIER TRANSFORM INFRARED SPECTROSCOPY OF DC DISCHARGES

Fourier transform infrared spectroscopy is presently utilized for high resolution absorption measurements of stable gas phase molecules on an almost routine basis. Application of this technique to unstable molecules is considerably more difficult; nevertheless, several very reactive radical species have now been studied by FTIR methods (36-38), including three molecular ions. Brault and Davis (36) successfully obtained the infrared emission spectrum of ArH^+ by FTIR in 1982, employing a hollow cathode discharge with flowing argon at 3 torr to generate the ion. Impurity levels of hydrogen were sufficient to optimize the ArH^+ concentration. An extensive infrared spectrum was observed, consisting of five bands with rotational states as high as $J = 35$. Attempts to duplicate this experiment for ArD^+ were not successful. Details of this pioneering work have been reviewed by Carrington and Softley (24).

A preliminary report of Fourier transform infrared emission spectra of ArH^+ , ArD^+ , and KrH^+ has been given by Johns (37). His corresponding experiments on HeH^+ and NeH^+ , were intriguingly unsuccessful. Hollow cathode discharge sources were also employed in this work. A detailed analysis of these interesting and important results is anxiously awaited. It appears that FTIR methods can now be generally applied to the study of molecular ions, although the level of difficulty still remains quite high.

VELOCITY MODULATION INFRARED LASER SPECTROSCOPY

The existence of a small, but detectable, Doppler shift ($\Delta\nu/\nu \sim 10^{-6}$) in the resonant absorption frequencies of molecular ions produced in DC glow discharges was first observed in 1975 by Woods et al. (28), whose microwave measurement of the $J = 0 \rightarrow 1$ rotational transition frequency for HCO^+ was found to exhibit a small systematic deviation from astrophysical measurements (39) of this same transition. Based on simple gas phase mobility considerations (40,41), the ion drift velocity in the axial electric field of the discharge was estimated to be ~ 1 Km/sec, which would result in a Doppler shift of 300 kHz for this transition at 89189 MHz. Indeed, after laboriously reconstructing their spectrometer so that the microwaves propagated anti-parallel to the positive ion drift direction (instead of parallel as in the previous measurements) the existence of a small but measurable Doppler shift (~ 100 kHz) was confirmed (42). (Fig. 1). Over the next seven years this tedious and time-consuming rebuilding process was obviated by employing symmetric electrodes in the discharge cell and a DC power supply which could be reversed in polarity. These modifications, combined with refinements in microwave frequency control and data acquisition, have enabled reliable Doppler shift measurements

to be made by microwave spectroscopy. (Fig. 2). A careful analysis of the Doppler shifts is important from the standpoint of obtaining accurate rest frequencies for molecular ion transitions. Similar shifts have also been observed and measured for higher rotational transitions of HCO^+ , NO^+ , CO^+ , and HNN^+ by DeLucia and co-workers (43-46).

Woods and co-workers have been able to exploit these Doppler shifts as a means of distinguishing between ionic and neutral spectra observed in DC glow discharges (47). For example, in their search for microwave vibrational satellite spectra of HCO^+ , the Doppler shift in the transition assigned to the (001) $J = 0 \rightarrow 1$ satellite was observed to be similar to that for the ground state $J = 0 \rightarrow 1$ transition. This quite unambiguously proved that the carrier of the previously unobserved transition at 88599.5 MHz was indeed ionic.

These microwave results clearly demonstrated that non-random ionic drift velocities within the positive column of a hydrogen glow discharge are comparable in magnitude to the mean random thermal velocities, and that the resulting spectral shifts could not only provide a non-intrusive measure of the plasma electric field or ionic mobility, but could also be used to distinguish between ionic and neutral spectra. Furthermore, these results indicated, although not quite so evidently, that the extension of these techniques to the infrared spectroscopy of molecular ions would permit full advantage of the Doppler shift measurements to be taken, since collisional broadening-- the dominant mechanism of microwave line-broadening is usually much smaller than the Doppler broadening at infrared wavelengths. Moreover, the wide range of rovibrational quantum states accessible by infrared studies within a relatively narrow bandwidth presents the possibility for the quantum state dependence of ionic transport properties (mobility and diffusion) to be examined quantitatively.

The extension of these concepts to infrared spectroscopy of molecular ions was pursued simultaneously by two research groups, both of which have been quite successful in this endeavor, even though their respective studies were directed toward different objectives. Haese, Pan, and Oka (48) at the University of Chicago, have measured Doppler shifts in the fundamental and hot bands of ArH^+ at 2500 cm^{-1} . Their mobility spectrometer consisted of diode laser-generated counter-propagating single-pass infrared beams which probed the positive column of an air-cooled, predominantly helium DC discharge. The red- and blue-shifted absorption profiles of the ion were simultaneously observed by detecting each beam independently with HgCdTe detectors. High sensitivity was achieved by frequency modulating the diode laser source and demodulating the absorptions at $2f$ by phase-sensitive amplification. Electric field measurements made with platinum wire probes inserted into the plasma were combined with the spectroscopically derived drift velocities to obtain ion mobilities. Large Doppler shifts [$\Delta\nu(\text{red-to-blue}) \approx \Delta\nu(\text{FWHM})$] were observed (Fig. 3), and the resulting mobilities were found to agree very nicely with classical measurements of ArH^+ mobilities in He based on drift tube data (49). In this first examination of quantum state dependent ionic mobilities, it was found that the rotational state dependence was less than 10%-- the precision achieved in the shift measurements. On the other hand a comparison of the $(\nu, J) = (0,3) \rightarrow (1,2)$ and $(1,2) \rightarrow (2,3)$ spectral shifts revealed a marginally significant (10%) mobility dependence on vibrational state, suggesting that $\nu = 1$ excited state ArH^+ ions are more mobile than ground state ArH^+ . This pioneering work of Haese, et al. has shown that state-specific mobilities can indeed be determined by high resolution laser spectroscopy, although there exists a need for more precise frequency shift measurements before this technique

and
 can elucidate the weak vibrational/rotational state dependences, and
 achieve an overall level of precision competitive with that of classical
 drift tube studies.

Velocity modulation spectroscopy of molecular ions has been developed
 at the University of California - Berkeley by Saykally and co-workers as a
 means of exploiting the Doppler shifts of charged molecules to discriminate
 against the overwhelmingly more abundant neutral species that exist in a
 plasma, rather than as a method for measuring the Doppler shifts themselves.
 Early in 1983 Gudeman, Begemann, Pfaff, and Saykally (50) reported the
 use of an audio frequency AC glow discharge and phase-synchronous demodu-
 lation of the absorbed infrared laser radiation for the detection and
 measurement of the ν_1 fundamental (C-H stretch) of HCO^+ . In this experi-
 Fig. 4)
 ment/an infrared color center laser was used as a source of tunable
 narrowband (1 MHz) radiation, which traversed the positive column of the
 AC plasma in a single pass. A 10/1 mixture of H_2 and CO at a total pressure
 of 800 mTorr was flowed through a 1 cm diameter x 100 cm long Pyrex dis-
 charge cell, the electrodes of which were placed off-axis in sidearms so
 that the infrared radiation probed only the positive column of the plasma.
 The absorption path was surrounded by a Pyrex jacket cooled with flowing
 liquid nitrogen. In these early experiments, the HCO^+ absorption spectrum
 could not be observed without this cooling. Discharge currents of 30-100 mA
 were achievable, with the maximum available current producing the strongest
 signals and the highest rotational temperatures. The total laser power
 traversing the plasma was typically $\sim 50 \mu\text{W}$ (although far more power was
 available from the color center laser system), and was detected by a liquid
 nitrogen cooled InSb photovoltaic detector. When tuned off-resonance with
 an ionic rovibrational transition, the laser power at the detector would

remain constant. When tuned through a molecular ion resonance, however, the power would be modulated at the audio frequency (1f) of the discharge, since the symmetric oscillating electric field Doppler-shifts the absorption frequency of the ionic vibration-rotation transition in and out of resonance with the infrared radiation. Another viewpoint is that in the reference frame of the velocity-modulated ion, the laser radiation appears to be frequency modulated. Simple lock-in demodulation at 1f then provides substantial suppression (~20-40 dB) of the strong and numerous absorptions due to neutral species, which are essentially unaffected by the electric field, while absorptions due to molecular ions are nearly 100% amplitude modulated.

To date the Berkeley color center laser velocity modulation effort has been successful in detecting and measuring spectra for six different molecular ions: H_3O^+ , NH_4^+ , H_2F^+ , HCO^+ , HNN^+ , and H_3^+ . Of these, the first five had never before been detected with high resolution infrared techniques, while the first three had not previously been observed by any form of high resolution spectroscopy. The two most important features of velocity modulation which have made these measurements possible are the inherent high sensitivity of narrow bandwidth phase-synchronous detection and the nearly complete suppression of neutral absorptions. The suppression has been found to be especially important in the detection of H_3O^+ and NH_4^+ , where the O-H and N-H stretching modes of these species are intimately overlapped by the corresponding modes of their neutral precursors, simply because the bonds involved are very similar. Thus the suppression of H_2O and NH_3 transitions, which are extremely strong and numerous in this region, has been essential.

The original detection of the $\text{HNN}^+ \nu_1$ (N-H stretch) band at 3.1 μm (51) was made by Gudeman, et al. using the same approach employed for HCO^+ . These spectra revealed only simple P- and R-branches, and therefore provide further experimental confirmation that HNN^+ , like HCO^+ , is indeed linear. The observed HNN^+ spectra were quite strong (Fig. 5); the transitions at the peaks of this band ($J'' = 7,8$) absorbed ~3% of the infrared power and are the strongest infrared transitions observed for any molecular ion by velocity modulation.

The importance of H_3O^+ in chemistry, biology, astrophysics, and aeronomy, has provided a great stimulus to high resolution spectroscopists for many years, but the strongly interfering H_2O vibrational spectrum has prevented a detailed study of this ionic species until very recently. The ν_3 band (doubly degenerate, asymmetric stretch) of H_3O^+ was first observed and analyzed (52) by Begemann, et al. at Berkeley, using velocity modulation spectroscopy; H_2/O_2 and $\text{H}_2/\text{H}_2\text{O}$ mixtures in air-cooled discharges and H_2/O_2 in liquid nitrogen cooled plasmas were found to yield comparable signal amplitudes. The rotation-vibration transitions of this band were, in general, much weaker (fractional absorption $\approx 0.1\%$) than those observed for the HCO^+ and HNN^+ because of the relatively higher density of states populated in a symmetric top species. The total integrated band strength suggested that the densities of HCO^+ , HNN^+ , and H_3O^+ , in their respective optimum plasmas, were similar. Nearly 100 transitions in the liquid nitrogen cooled ν_3 spectrum of H_3O^+ have now been measured and assigned. (Fig. 6) All of these have been observed as well in air-cooled plasmas although in this latter case an additional ~240 transitions have also been detected. These cannot simply be assigned to higher-J ν_3 transitions or to the ν_1 band of H_3O^+ . Additional work on these interesting spectra is currently in progress.

Protonated ammonia (NH_4^+) bears a chemical importance nearly equal to that of H_3O^+ . The ν_3 band of NH_4^+ (triply degenerate asymmetric stretch) near $3.0 \mu\text{m}$ was detected simultaneously by Crofton and Oka (53) and by Schäfer *et al.* (54) at room temperatures in mixtures of H_2 and NH_3 . In more recent work over 200 transitions of NH_4^+ in this band have been observed and analyzed by Schäfer, Saykally, and Robiette (55). The tetrahedral spherical top structure of NH_4^+ was clearly evident in the observed ν_3 spectrum, which displayed remarkable similarities to that of the iso-electronic methane molecule.

The fluoronium ion H_2F^+ , the ionic analog of water, has also been studied at Berkeley by Schäfer and Saykally (56). Over 300 transitions have been assigned to both the ν_3 (asymmetric F-H stretch) and the ν_1 (symmetric F-H stretch) modes. Air-cooled glow discharges through H_2/HF mixtures produced these bands which were free from Fermi resonance because of symmetry restrictions, even though their vibrational frequencies are very nearly degenerate.

The chemical, astrophysical, and theoretical importance of H_3^+ demands that an entire review be dedicated to its discussion, and such a review has been presented by Oka (57). In the course of the recent extensive H_3O^+ spectral search (52) by Begemann, *et al.*, however, two new broad ionic transitions were detected at a lock-in phase 180° different from all H_3O^+ absorption lines. These were first believed to be due to a negative ionic carrier, but a more extensive study of these species revealed that their signal strengths were maximized in liquid nitrogen cooled plasmas, of pure H_2 , wherein the H_3O^+ spectrum was not observable at all. A careful scan over 2/3 of the entire color center laser bandwidth yielded 41 transitions, of which approximately 1/2 were in-phase with the discharge current and

1/2 were 180° out of phase. Furthermore, 2f population modulation of these transitions indicated that those which were in-phase absorbed laser power, while the out of phase lines were observed in stimulated emission. Although an analysis of this spectrum at 2.76 μm is not yet complete, Gudeman and Saykally (58) have tentatively assigned it to transitions between the $2\nu_1$ (symmetric breathing) and ν_2 (asymmetric stretching) vibrational levels of the triangular H_3^+ molecular ion. A preliminary analysis indicates that it is the R-branch transitions and some of the Q-branch lines that are observed in stimulated emission, while the P-branch transitions are absorbing. Because the symmetric (ν_1) mode is metastable (infrared inactive), the existence of nearly equal populations in the $2\nu_1$ and ν_2 levels is not surprising. The observed vibrational frequency is reasonably close to that predicted by Carney and Porter (59) for this transition, thus providing additional support for the tentative assignment. A complete analysis is in progress and will appear shortly (58).

Infrared studies of molecular ions are, of course, not limited to applications employing relatively high power color center lasers as sources of infrared radiation. Indeed, the very low power requirement of direct absorption detection is particularly well-suited for the application of other state-of-the-art infrared sources, which can vastly increase the bandwidth accessible to the velocity modulation experiment. Two notable extensions have been reported. The first involved use of the infrared difference frequency laser source, previously employed (30-32) in the study of molecular ions by Oka and colleagues, as discussed earlier in this paper. It is not surprising, therefore, that the combination of the difference frequency laser source with velocity modulation by Crofton and Oka (53) at the University of Chicago has been another important advance

in the study of infrared spectra of molecular ions, first demonstrated in their work (53) in the ν_3 band of NH_4^+ .

In the most recent application of the velocity modulation technique, Altman, Crofton, and Oka (60) have reported the detection and analysis of the C-H stretching (ν_2) mode of HCNH^+ , which was observed in air-cooled H_2/HCN plasmas using their difference frequency laser source spectrometer near 3.1 μm . This represents the first detection of this linear species by any spectroscopic technique, yielding a very accurate prediction of its $J = 1 \leftarrow 0$ pure rotational transition (74112.5 ± 6.0 MHz), which will greatly facilitate laboratory and astrophysical microwave efforts in the search for this extremely important charged molecule.

A similar system, combining difference frequency infrared generation and velocity modulation has been employed by Nesbitt et al. in a collaborative effort at U. C. Berkeley. In this latter work, laser source noise subtraction has been found to be a very effective means of increasing detection sensitivity, even though power levels on the order of only 5 μW were available. Detailed studies of the deuterated ions DNN^+ (61) and D_3O^+ (62) have been made thus far in this joint effort. The combination of infrared diode laser sources with velocity modulation has also been pioneered in Chicago. Haese and Oka have recently reported (63) the detection of the H_3O^+ ν_2 band (the umbrella mode) near 10 μm using a diode laser and HgCdTe photoconductive detector. This study serves not only as a key step in measuring the barrier to inversion for H_3O^+ , but also provides infrared transition frequencies which are not obscured by atmosphere H_2O and can therefore be applied to an astrophysical search for this important ionic species.

Within one week of the first observation of HCO^+ , the ν_1 band of the isoelectronic molecular ion HNN^+ (protonated nitrogen) was also observed at Berkeley. Within one year of this first observation, a total of seven chemically distinct molecular ions, including 17 different vibrational bands of 12 unique isotopic variants, have been reported by the two groups employing velocity modulated infrared laser spectroscopy. This work yielded a total of ~1400 lines, 1100 of which have now been assigned and analyzed. Results of these numerous measurements include spectroscopic constants, molecular structures, and a more complete understanding of the molecular ion chemistry in partially ionized plasmas. In Table I we have compiled the spectroscopic and structural information for the various bands and isotopic variants which have been analyzed so far.

From a chemical point of view, the species observed have been produced in predominantly (~70%), $\text{H}_2(\text{D}_2)$ plasmas, with the remainder comprised of the appropriate neutral to yield the proton adduct. The individual experiments provide very interesting chemical information, however, and these merit some additional discussion. As mentioned above, HCO^+ was not observed in an ambient temperature plasma, although HNN^+ was, albeit rather weakly. It has been shown by Haese in mass spectrometric studies of air-cooled H_2/CO discharges (64) that the H_3O^+ ion actually dominates HCO^+ , thus indicating that water is rapidly formed from CO and H_2 and that liquid nitrogen cooling reduces the H_2O level sufficiently to allow CO to complete effectively with H_2O for the proton. The strong H_3O^+ signals observed at Berkeley in room temperature H_2/O_2 , H_2/CO , and H_2/CO_2 plasmas further suggest that any source of atomic oxygen in H_2 plasmas quickly reacts to form H_2O . Moreover, HNN^+ is only weakly observable at ambient temperatures, implying that ammonia is a stable product of H_2/N_2 plasmas. The production rate of NH_3 , and thus

NH_4^+ does, however, appear to be slower than that of water and H_3O^+ in similar H_2/O_2 mixtures, since NH_4^+ is only weakly observed in H_2/N_2 mixtures. This suggests that electron impact cleavage of N_2 is inefficient, and that proton transfer to atomic nitrogen is slow. This is in accord with gas phase ion-molecule kinetic studies (65) employing ion-cyclotron resonance and flowing afterglow techniques. Generally speaking, it is observed that the ion chemistry of these discharges occurs on a sufficiently rapid timescale to yield the most chemically stable ionic species as the dominant ionic constituent, which has been termed the "terminal ion" or, more colloquially, as the "end-of-the-food-chain".

In the remainder of this section, several recent extensions and additional applications of velocity modulation laser spectroscopy will be discussed. These include electronic spectroscopy of molecular ions using tunable dye lasers, spectroscopy of neutral radicals using discharge population modulation, and dynamical studies of plasmas based on observed rotational, vibrational, and translational distribution of the ions and neutrals within the plasma.

The extension of velocity modulation to visible wavelengths follows quite naturally from a simple consideration of Doppler shifts and Doppler linewidths -- both are proportional to the transition frequency, and the ratio of shift to width will therefore be independent of frequency, provided the linewidth of the transition remains Doppler-limited. Moreover the highly sophisticated technology available at visible wavelengths, including tunable lasers, fast detectors, and electro-optic devices, permits more elaborate development of these spectroscopic methods to be made with considerably more ease, compared with the technology presently available in the infrared. Gudeman, Martner, and Saykally (66) have recently reported

the extension of velocity modulation to electronic spectroscopy in their detection of the $A^2\Pi \leftarrow X^2\Sigma$ systems for both CO^+ and N_2^+ in direct absorption. The $B \leftarrow X$ system of N_2^+ has long been the prototypical species for the development of techniques for molecular ion electronic spectroscopy; the $A \leftarrow X$ system, on the other hand, is inherently much weaker due to the long radiative lifetime of the A state and the additional intensity dilution resulting from the Π state partition function. Nevertheless several vibronic bands have been observed by velocity modulation for N_2^+ and CO^+ . The CO^+ (Fig. 7) and N_2^+ spectra were easily observed in AC plasmas composed mainly of He (1-8 Torr) with relatively small amounts of CO or N_2 (50-150 mTorr), and the absorption signal strengths were surprisingly insensitive to chemical composition within this range. In accord with the large Doppler shifts observed (48) for ArH^+ in He by Haese et al. in DC plasmas, He correspondingly serves well as a buffer gas for velocity modulation in AC plasmas.

The methodology of these visible studies is similar to that described above in connection with infrared techniques, except that the tunable infrared source has been replaced with a single mode dye laser. Also, laser output amplitude noise, which typically limits the detection sensitivity, has been greatly reduced by employing a spacial double beam configuration.

The wide range of vibrational and rotational states accessible by electronic spectroscopy provides a convenient quantum state-selective probe of the plasma environment. Rotational and vibrational distributions have been determined (67) for both CO^+ and N_2^+ from relative intensity measurements, and the translational energy has been estimated from the Doppler-limited linewidths. Furthermore, these non-intrusive investigations can potentially provide spatial distributions of these dynamical parameters and can be

combined with radiative lifetimes and Franck-Condon factors to determine absolute densities of the ionic species. The extension of the velocity modulation technique to ultraviolet wavelengths is anticipated in the near future, where nonlinear mixing sum frequency generation techniques will be applicable. This will permit the first observation of allowed singlet-singlet electronic transitions of the chemically important closed shell proton adducts, which are presently accessible only by vibrational or rotational spectroscopy.

The application of AC discharge modulation actually goes well beyond that of velocity modulation spectroscopy of molecular ions. Population modulation of short-lived radicals in 50% duty-cycle pulsed discharges can be combined with phase-synchronous detection of the absorbed radiation to yield the difference in populations in these species between the on and off portions. For very short-lived species ($\tau \ll 1/f$, where τ is the effective lifetime of the radical and f is the discharge pulse rate), the population will closely follow the discharge current, and spectral transitions will essentially be fully modulated. For longer lived species, however, the modulation depth will decrease, and a phase lag in the population with respect to the discharge current will become evident. Amplitude and phase of absorption signals therefore provide important discriminatory information, which can be crucial in the assignment of congested and multi-component spectra observed in these plasmas.

Population modulation in pulsed discharges was first noted in 1981 by Hirota (68) and co-workers in Okazaki, where the infrared spectra of neutral SF radical within OCS/CF₄ plasmas have been studied. This method is also applicable to molecular ions and has been used very recently by Amano (69) in a follow-up study of the Berkeley work on the ν_1 band in HCO⁺.

Symmetric bipolar AC discharges have also been found to lend themselves

very conveniently to population modulation. For an ideal symmetric discharge current waveform, the population of all species in the plasma is equal during each half cycle and the suppression of neutral absorption signals is therefore complete for 1f detection. For 2f demodulation, however, the plasma density passes through a minimum once each (2f) cycle, and the absorption signal is equivalent (except for the amplitudes of the Fourier components making up the absorption signal waveform) to that observed in the pulsed discharge modulation discussed above. Conventional lock-in amplifiers are easily modified for 2f, as well as 1f, demodulation. Hence, the experimenter can virtually turn the neutral absorption signals off and on by simply switching from 1f to 2f detection. Many neutral species, both stable and short-lived ones, have been observed and assigned based on 2f detection and phase discrimination. In the Berkeley color center laser effort, these include OH ($v = 1 \leftarrow 0$), CO ($\Delta v = 2$, $v'' = 0, 19, 20$, and 21), HCN (v_1), H₂O (v_1 and v_3), NH₃ (v_1 and v_3), and atomic Ar, He, and H Rydberg transitions.

THE THEORY OF VELOCITY MODULATION LASER SPECTROSCOPY

The success of the velocity modulation technique depends on the fact that drift velocities comparable to random velocities can be realized for molecular ions in discharge plasmas. This certainly is not true for discharge plasmas in general, hence, it is important to consider quantitatively the parameters which determine the magnitude of the drift and random velocities, or correspondingly, the Doppler shifts (δv) and widths (Δv) of molecular ion absorption profiles. This description can then be used to assess the effectiveness of ion velocity modulation in terms of modulation depth ($\delta v / \Delta v$). Beyond the importance of this technique as a means for discrimination against neutral absorption signals, we are also interested

in its applicability for quantitative measurements of the spectral line-widths, lineshifts, and intensities which, in turn, permit dynamical aspects of the plasma environment to be examined on a quantum state resolved basis. Extraction of such dynamical information from observed velocity and population modulated absorption profiles depends on having a model which accounts for the dependence of the velocity modulation lineshapes on the discharge plasma parameters. In this section we discuss such a model in a semiquantitative fashion.

The average drift velocity, v_d (cm/sec), of an ion moving through a neutral gas under the accelerating force of an external electric field E (volts/cm), can be conveniently expressed (40,41) as the product of the field and the ionic mobility K ($\text{cm}^2 - \text{volt}^{-1} - \text{sec}^{-1}$),

$$v_d = KE. \quad (1)$$

We must note that K is not necessarily independent of the field strength, although at low and intermediate fields ($E/P \leq 10 \text{ volts-cm}^{-1} - \text{torr}^{-1}$), this is typically the case. A quantitative definition of high and low fields can be found in the treatise of McDaniel and Mason (40), but for the plasmas presently employed for velocity modulation in which the drift energy of the ion is comparable to its random thermal energy, the intermediate fields case applies. The magnitude of K depends upon the nature of the electrodynamic interaction between the ion and the neutral species, and upon the efficiency of momentum transfer between the two masses. For the simplest case, where the neutral is a polarizable sphere and the ion is a charged sphere, the interaction is governed by the monopole-induced-dipole attractive potential, which varies as r^{-4} , and is proportional to the dipolar polarizability (\AA)³ of the neutral. A "reduced mobility", K_0 , can be

expressed as

$$K_0 = 13.876/(\alpha\mu)^{\frac{1}{2}}, \quad (2)$$

the derivation of which is generally credited to Langevin (70,71) in 1905; it is therefore known as the "Langevin" mobility. Here the reduced mass μ (amu) of the ion-neutral collision pair reflects the efficiency of momentum transfer. The effective mobility can then be expressed in terms of K_0 as

$$K = K_0 (760/p(\text{torr}))(T(\text{Kelvin})/273.16). \quad (3)$$

We can estimate the magnitude of Doppler shifts ($\delta\nu$) expected for ionic transitions with the standard result

$$\delta\nu = \nu_0(v_d/c) \quad (4)$$

and estimates of the field and neutral molecule translational temperature within the plasma. For HCO^+ in 1 torr H_2 , the axial field of the positive column has been estimated to be 20 volts-cm⁻¹ using high impedance probes inserted into the plasma, while the rotational distribution of HCO^+ in this environment is consistent with a neutral temperature of 200 K (Assuming that the ionic rotational populations are equilibrated with the neutral gas translation temperature). Equations (1)-(4) then predict

$$\delta\nu = 390 \text{ MHz } (\alpha_{\text{H}_2} = .808 \text{ \AA}^3, \nu_0 = 3089 \text{ cm}^{-1}).$$

This shift must be comparable to or larger than the Doppler broadened line-width if the ionic absorptions are to be fully modulated and maximum sensitivity is to be achieved. The Doppler width ($\Delta\nu(\text{HWHM})$) is given by (72)

$$\Delta\nu = 3.581 \times 10^{-7} \nu_0 (T(\text{Kelvin})/m(\text{amu}))^{\frac{1}{2}}, \quad (5)$$

and extending the HCO^+ example, we obtain $\Delta\nu = 90$ MHz, which indeed indicates that ionic absorptions will be significantly overmodulated! In this limit, where $\delta\nu > \Delta\nu$, the demodulated line profile would appear as two isolated Gaussians separated by $2\delta\nu$, and with equal but opposite intensities and equal widths. As the drift velocity is decreased, either by reducing the electric field or by decreasing the ion mobility, the two Gaussians move closer together, with overlap of the red- and blue-shifted components ($\delta\nu < \Delta\nu$) leading to cancellation of intensity and the loss of sensitivity. It is convenient to define the modulation depth, $\delta\nu/\Delta\nu$, which is completely analogous to that commonly used in derivative spectroscopy (since in the limit where $\delta\nu/\Delta\nu \leq 1$, velocity modulation is, in fact, simply derivative spectroscopy). The ratio of the fully modulated absorption amplitude to the amplitude of an undermodulated absorption is roughly equal to $\delta\nu/\Delta\nu$; positions of the positive and negative maxima of the derivative profile occur at $\nu_0 \pm (\Delta\nu/\sqrt{2\ln 2})$ (where ν_0 is the rest frequency of the ionic transition), and are independent of $\delta\nu$ for $\delta\nu/\Delta\nu < 1$. Lineshift information is virtually lost in this case, and is very strongly correlated to the loss of amplitude due to the overlap.

This apparently desperate situation is easily rectified, however, since the intensity information is recoverable from the 2f population modulated signal when a symmetric bipolar double square wave signal is used to drive the AC discharge. The demodulated molecular ion absorption profile for this 2f case is composed of two overlapping Gaussians of equal intensity, sign and width and separated by $2\delta\nu$. This is similar to the demodulated 1f signal, except that in the latter case the two profiles are opposite in sign. For $\delta\nu/\Delta\nu < 1$, the 2f absorption profile consists of an unresolved doublet, and thus appears as a single line. A simultaneous fit of both the 1f and 2f

demodulated line profiles to two Gaussians, which are described by a single width, intensity, separation, and average rest frequency, then provides sufficient information to determine the three relative lineshape parameters with very small correlations. In the absence of the requisite non-linear least squares fitting routines, fairly good estimates of the shift, width, and intensity can be made in the limits where $\delta\nu/\Delta\nu > 1$ or $\delta\nu/\Delta\nu < 1$. For a modulation depth greater than one the estimates are trivial; for $\delta\nu/\Delta\nu < 1$, the 1f derivative maxima are separated by $2\Delta\nu/\sqrt{2\ln 2}$, and the ratio of the peak-to-peak 1f signal amplitude to the 2f amplitude is approximately

$$\frac{2(2\ln 2)^{1/2}(\delta\nu/\Delta\nu)e^{-.5}}{\exp[(\delta\nu/\Delta\nu)^2 \ln 2]} \quad (6)$$

For the intermediate case where $\delta\nu/\Delta\nu \approx 1$, which, in fact, usually prevails, nonlinear least squares analysis is necessary for accurate estimates. While making the simultaneous 1f and 2f absorption measurements, it is critical that the double square wave discharge current waveform have a duty cycle $\leq 50\%$, i.e., the discharge must shut off for at least a full 1/4 cycle twice each cycle. Otherwise the 2f population changes will be undermodulated.

It was predicted above that 1f absorptions will be overmodulated by a factor of $\delta\nu/\Delta\nu \approx 4$, which is in marked contrast to those actually observed for HCO^+ and similar molecular ions in the H_2 discharges. The widths and shifts are approximately the same for these systems. As noted in the previous section, however, Haese et al. have detected large shifts for ArH^+ in DC He plasmas (48) and have found that a model identical to that given above describes the observed shifts quite sufficiently.

In general, it appears that this simple model cannot adequately explain our observations, and that the limitations which are imposed upon the velocity modulation technique can not yet be fully assessed. Several qualitative observations and considerations are helpful at this stage. First, it must be noted that the positive column of H_2 plasmas, and of molecular plasmas in general, are visibly striated (73). The effects of striations upon the drift motion of charged molecules has been considered previously (47) in connection with microwave Doppler shift observations by Gudeman and Woods, who conclude that the non-uniform vacillating axial electric field will produce bunches of ions concentrated in the low field wells because total current flux must be conserved. A two-fold reduction in the modulation depth $\delta v/\Delta v$ results in this case, due first to a decreased Doppler shift, since the field in the neighborhood of the ion bunch is lower than the average axial field, and second to broadening and distortion of the idealized Gaussian profile, because marked spatial drift velocity dispersion exists along the striation.

It must also be realized that estimates of neutral gas translational temperatures in the plasma are very difficult to make. Conventional thermometry can measure only a weighted average of the neutral, ionic, and electron temperatures. Although the ions and electrons are far lower in abundance, average electron temperatures of several eV (10^4 - 10^5 Kelvin) are typical, resulting in an overestimation of the neutral temperature. Doppler-broadened linewidths of probe molecules within the plasma are, in principle, a more reliable measure of their translation temperature, but such reliable linewidth measurements are notoriously difficult to make. Rotational temperatures of neutral species tend to be well-equilibrated with their translational energy, and therefore serve as a more convenient means of estimating the

neutral temperature, since they depend simply on the relative intensities of resolved rotational transitions. Thus, it is anticipated that rotational intensity distributions will be a very important diagnostic in future mobility studies in active plasmas.

The limitations of the simple Langevin ion-neutral interaction potential assumed above must also be considered; only the simplest collisional interaction has been incorporated in the present treatment. Bowers and co-workers (74) have shown that the monopole-dipole interaction can greatly increase chemical reaction rates, which suggests that ionic mobilities in polar gases will be substantially reduced. For high fields the simple Langevin picture has also been shown to be inadequate (40) and must be modified to reflect a $E^{1/2}$ dependence of the ionic drift velocity. For systems where resonant charge transfer or proton transfer can occur, mobilities well below those predicted from monopole-induced dipole potentials have been observed in conventional time-of-flight measurements (40). These limitations occur often in chemically important plasmas, and the need for a more complete model which can accurately treat these effects in conjunction with the spatial variations of the plasma (striations) is urgently needed.

A simple extension of the monopole-induced dipole model permits the mobility of an ion in a known mixture of gases to be treated (40). This extension, known as Blanc's Law, can be expressed as

$$1/[K_{\text{mix}}] = \chi_1/[K_1] + \chi_2/[K_2] + \dots, \quad (7)$$

where K_i 's are the mobilities of the ion in the corresponding pure gases and the χ_i 's are the molar fractions. The importance of this law becomes evident when one considers the change of mobility of HCO^+ in going from pure H_2 to a 10/1 mixture of H_2 and CO . Assuming Langevin mobilities for

K_{H_2} and K_{CO} , one finds that $K_{mix} = .8 K_{H_2}$. However, resonant proton transfer, monopole-dipole, and monopole-quadrupole interactions of HCO^+ with CO are likely to lower K_{CO} significantly from the Langevin prediction and ultimately yield $K_{mix} \sim .5 K_{H_2}$, even for this 10/1 mixture.

CONCLUDING REMARKS

The first velocity modulation spectra of a molecular ion (HCO^+) were measured on Christmas Eve of 1982. Only one year after its inception, it is clear that velocity modulation laser spectroscopy has already had a substantial impact on the study of molecular ions, having produced high quality spectroscopic data for HCO^+ , HNN^+ , H_3O^+ , NH_4^+ , H_2F^+ , H_3^+ , $HCNH^+$, D_3O^+ , and DNN^+ in the infrared and for CO^+ and N_2^+ in the visible. We emphasize that the experimental realization of velocity modulation of molecular ions in low density plasmas represents but the latest stage of evolution of the original ideas put forth by Woods et al. (28) in 1974.

The measurements, assignments, and analyses of vibrational spectra of molecular ions discussed in this article were greatly facilitated by the existence of high quality ab initio calculations of vibrational frequencies and intensities, made by several theory groups. The calculations of Hennig, Kraemer, and Dierkson (75) have been extremely valuable for studies of HCO^+ , HNN^+ , and their isotopes; Botschwina's results (76) for H_2F^+ have been of enormous help in our assignment and analysis of the ν_1 and ν_3 band measurements, and Carney and Porter's work on H_3^+ (59) has been important to the success of both the Wing and Oka experiments on that ion. Bunker, Kraemer, and Spirko (77), Botschwina (78), and Colvin, Raine, Schaefer, and Dupius (79) have all published important results for H_3O^+ . The calculations of the Schaefer group at Berkeley have been of particular significance to this work. Both the Berkeley and Chicago spectroscopy groups have relied heavily on their

results for H_3O^+ (79), NH_4^+ (80), and H_2CN^+ (81). It is most encouraging to note the excellent agreement that has been found between the ab initio results of these groups and the experimental measurements. This indicates that similarly reliable theoretical calculations will be available for guiding future experiments on increasingly larger and more complex molecular ion systems, where such guidance is likely to be an absolute necessity. We encourage molecular theoreticians to press forward with detailed calculations on complexed ions, such as $\text{H}_3\text{O}^+ \cdot n\text{H}_2\text{O}$, and on negative ions, like CCH^- , as these will probably become experimentally accessible in the relatively near future. The former case presents two major obstacles to theoreticians - computation of an accurate potential surface, including accurate barriers to tunneling and isomerization, and a rigorous treatment of the large amplitude vibrations that will clearly occur in complexed ions; the resolution of these difficult problems will substantially increase our comprehension of the structures and dynamics of these important prototypes of solvation and proton transfer.

ACKNOWLEDGMENTS

The Berkeley Infrared Spectroscopy effort is supported by the National Science Foundation, Grant # CHE 82-07307. The visible laser velocity modulation experiments were supported by the Director, Office of Energy Research, Office of Basic Energy Sciences, Chemical Sciences Division of the U. S. Department of Energy under Contract No. DE-AC03-76SF00098. CSG was supported by the Petroleum Research Fund, Grant # 12096-G6, and by a fellowship from IBM. The dye laser equipment was rented from the San Francisco Laser Center, operating under a grant from the National Science Foundation Grant #CHE 79-16250.

We thank Ms. Cordelle Yoder for typing this manuscript under the usual emergency conditions.

BIBLIOGRAPHY

- (1) Saykally, R. J., Woods, R. C. 1981. Ann. Rev. Phys. Chem. 32:403.
- (2) Amano, T. 1983. Bull. Soc. Chim. Belg. 92:565.
- (3) Miller, T. and Bondybey, V. E. 1982. Appl. Spscopy Rev. 18:105.
- (4) Miller, T. A., Bondybey, V. E. (eds.), 1983. Molecular Ions: Structure and Chemistry, Amsterdam: North-Holland Publishing Co.
in
- (5) Andrews, L. 1980. Molecular Ions: Geometric and Electronic Structure, NATO ASI, ed. J. Berkowitz and K. Groeneveld, New York: Plenum.
- (6) Schwarz, H. A., 1977. J. Chem. Phys. 67:5525; Schwarz, H. A., 1980. J. Chem. Phys. 72:284.
- (7) Huber, K. P. and Herzberg, G. H. 1979. Molecular Spectra and Molecular Structure IV: Constants of Diatomic Molecules. New York: Van Nostrand-Reinhold Co.
- (8) Wing, W. H., Ruff, G. A., Lamb, W. E., Spezeski, J. J. 1976. Phys. Rev. Lett. 36:1488.
- (9) Tolliver, D. E., Kyrala, G. A., Wing, W. H. 1979. Phys. Rev. Lett. 43:1719.
- (10) Shy, J.-T., Farley, J. W., Lamb, W. E., Wing, W. H. 1980. Phys. Rev. Lett. 45:535.
- (11) Shy, J.-T., Farley, J. W., Wing, W. H. 1981. Phys. Rev. A. 24:1146.
- (12) Wing, W. H. 1977. Springer Series in Optical Sciences, Volume 7: Laser Spectroscopy III, ed. J. L. Hall, J. L. Carlsten, Berlin: Springer-Verlag.
- (13) Wing, W. H. private communication, 1984.
- (14) Carrington, A., Buttenshaw, J. 1981. Molec. Phys. 44:267.
- (15) Carrington, A., Buttenshaw, J., Kennedy, R. 1983. Molec. Phys. 48:775.

- (16) Carrington, A., Buttenshaw, J., Kennedy, R. A. 1982. J. Mol. Structure. 80:47.
- (17) Carrington, A., Buttenshaw, J., Kennedy, R. A., Softley, T. P. 1981. Molec. Phys. 44:1233.
- (18) Carrington, A., Kennedy, R. A., Softley, T. P., Fournier, P. G., Richard, E. G. 1983. Chem. Phys. 81:251.
- (19) Carrington, A., Buttenshaw, J., Kennedy, R. A., Softley, T. P. 1982. Molec. Phys. 45:747.
- (20) Carrington, A., Buttenshaw, J., Kennedy, R. 1982. Molec. Phys. 45:753.
- (21) Carrington, A., Kennedy, R. A., 1982. Ions and Light, ed. M. Bowers.
- (22) Carrington, A. 1979. Proc. Roy. Soc. London. A367:433.
- (23) Carrington, A. and Kennedy, R. A. 1984, preprint.
- (24) Carrington, A., Softley, T. P. 1983. "High Resolution Infrared Spectroscopy of Molecular Ions", in Reference 4.
- (25) Giese, C. F., Gentry, W. R. 1974. Phys. Rev. A. 10:2156.
- (26) LeRoy, R. J., Liu, W.-K. 1978. J. Chem. Phys. 69:3622.
- (27) Dixon, T. A., Woods, R. C. 1975. Phys. Rev. Lett. 34:61.
- (28) Woods, R. C., Dixon, T. A., Saykally, R. J., Szanto, P. G. 1975. Phys. Rev. Lett. 35:1269.
- (29) Saykally, R. J., Dixon, T. A., Anderson, T. G., Szanto, P. G., Woods, R. C. 1976. Astrophys. J. Lett. 205:L101.
- (30a) Oka, T. 1980. Phys. Rev. Lett. 45:531.
- (30b) Oka, T. 1981. Phil. Trans. Roy. Soc. London, A303:543.
- (31) Bernath, P., Amano, T. 1982. Phys. Rev. Lett. 48:20.
- (32) Wong, M., Bernath, P., Amano, T. 1982. J. Chem. Phys. 77:693.
- (33) Davies, P. B., Hamilton, P. A. 1983. Chem. Phys. Lett. 94:565.
- (34) Davies, P. B., Hamilton, P. A., Lewis-Bevan, W., Okamura, M. 1983. J. Phys. E: Sci. Instrum. 16:289.

- (35) Amano, T., Bernath, P. F., McKellar, A. R. W. 1982. J. Molec. Spectros. 94:100.
- (36) Brault, J. W., Davis, S. P. 1982. Physica Scripta. 25:268.
- (37) Johns, J. W. C. Thirty Seventh Symposium on Molecular Spectroscopy; Columbus, OH, June, 1982, p. 41.
- (38) Knights, J. C., Schmitt, J. P. M., Perrin, J., Guelachvili, G. 1982. J. Chem. Phys. 76:3414.
- (39) Snyder, L. E., Hollis, J. M. 1976. Astrophys. J. Lett. 204:L139.
- (40) McDaniel, E. W., Mason, E. A. 1973. The Mobility and Diffusion of Ions in Gases. New York:John Wiley and Sons.
- (41) von Engel, A. 1965. Ionized Gases; 2nd Ed. London: Oxford University Press.
- (42) Woods, R. C., Saykally, R. J., Anderson, T. G., Dixon, T. A., Szanto, P. G. 1981. J. Chem. Phys. 75:4256.
- (43) Sastry, K. V. L. N., Herbst, E., DeLucia, F. C. 1981. J. Chem. Phys. 75:4169.
- (44) Bowman, W. C., Herbst, E., DeLucia, F. C. 1982. J. Chem. Phys. 77:4261.
- (45) Sastry, K. V. L. N., Helminger, P., Herbst, E., DeLucia, F. C. 1981. Astrophys. J. Lett. 250:L91.
- (46) Sastry, K. V. L. N., Helminger, P., Herbst, E., DeLucia, F. C. 1981. Chem. Phys. Lett. 84:286.
- (47) Gudeman, C. S. 1982. Ph.D. Thesis, University of Wisconsin, Madison (unpublished).
- (48) Haese, N. N., Pan, F.-S., Oka, T. 1983. Phys. Rev. Lett. 50:1575.
- (49) Lindinger, W., Albritton, D. L. 1975. J. Chem. Phys. 62:3517.
- (50) Gudeman, C. S., Begemann, M. H., Pfaff, J., Saykally, R. J. 1983. Phys. Rev. Lett. 50:727.

- (51) Gudeman, C. S., Begemann, M. H., Pfaff, J., Saykally, R. J. 1983. J. Chem. Phys. 78:5837.
- (52) Begemann, M. H., Gudeman, C. S., Pfaff, J., Saykally, R. J. 1983. Phys. Rev. Lett. 51:554.
- (53) Crofton, M. W., Oka, T. 1983. J. Chem. Phys. 79:3157.
- (54) Schäfer, E., Begemann, M. H., Gudeman, C. S., Saykally, R. J. 1983. J. Chem. Phys. 79:3159.
- (55) Schäfer, E., Saykally, R. J., Robiette, A. G. 1984. J. Chem. Phys. (submitted).
- (56) Schäfer, E., Saykally, R. J. 1984. J. Chem. Phys. (submitted).
- (57) Oka, T., 1983. "The H_3^+ Ion", in reference 4.
- (58) Gudeman, C. S., Saykally, R. J. 1984. (in preparation).
- (59) Carney, G. D., Porter, R. N. 1976. J. Chem. Phys. 65:3547.
- (60) Altman, R. S., Crofton, M. W., Oka, T. 1984. (preprint).
J.
- (61) Nesbitt, D./, Petek, H., Gudeman, C. S., Moore, C. B., Saykally, R. J. 1984. J. Chem. Phys. (submitted).
J.
- (62) Petek, H., Nesbitt, D./, Begemann, M. H., Gudeman, C. S., Moore, C. B., Saykally, R. J. 1984. (in preparation).
- (63) Haese, N. N., Oka, T. 1984. J. Chem. Phys. 80:572.
- (64) Haese, N. N. 1981. Ph.D. Thesis, University of Wisconsin, Madison (unpublished).
- (65) Huntress, W. T. 1977. Astrophys. J. Suppl., 33:495.
- (66) Gudeman, C. S., Martner, C. C., Saykally, R. J. 1984. Chem. Phys. Lett. (submitted).
- (67) Martner, C. C., Gudeman, C. S., Saykally, R. J. 1984 (in preparation).
- (68) Endo, Y., Nagai, K., Yamada, C., Hirota, E. 1983. J. Molec. Spectrosc. 97:213.

- (69) Amano, T. 1983. J. Chem. Phys. 79:3595.
- (70) Langevin, P. 1905. Ann. chim. phys. 5:245.
- (71) McDaniel, E. W. 1964. Collision Phenomena in Ionized Gases, New York: John Wiley and Sons.
- (72) Townes, C. H., Schawlow, A. L. 1975. Microwave Spectroscopy, New York: Dover Publications, Inc.
- (73) Garscadden, A. 1978. in Gaseous Electronics, ed. Hirsch and Oskam, Vol. I, New York:Academic Press.
- (74) Su, T., Su, E. C. F., Bowers, M. T. 1978. J. Chem. Phys. 69:2243.
- (75) Hennig, P., Kraemer, W. P., and Diercksen, G. H. F. 1978. Max Planck Institut für Physik und Astrophysik, (unpublished report).
- (76) Botschwina, P. 1980, in Molecular Ions:Geometric and Electronic Structures, NATO ASI, /J. Berkowitz and K. Groeneveld, eds. New York: Plenum.
- (77) Bunker, P. R., Kraemer, W. P., Spirko, V., to be published.
- (78) Botschwina, P. 1983. to be published.
- (79) Colvin, M. E., Raine, G. P., Schaefer, H. F., Dupuis, M. 1983. J. Chem. Phys. 79:1551
- (80) Yamaguchi, Y., Schaefer, H. F. 1980. J. Chem. Phys. 73:2310.
- (81) Lee, T. J., Schaefer, H. F. III, 1984. J. Chem. Phys. 80:xxxx.

Table I Molecular ions studied by high resolution infrared spectroscopy

HD⁺

(8) fast ion beam, $v = 0, 1, 2, 3$ ~~sampled with 7 transitions~~ sampled with 7 transitions; no constants determined

(14,16) two photon photodissociation, 9 rotational components of $v = 18-16$ measured, hyperfine splittings observed, but no hfs constants determined

$$\begin{aligned} \Delta G &= 916.2081(4) & B_{16} &= 7.33607(38) & D_{16} &= 7.201(52) \times 10^{-3} \\ H_{16} &= 3.1(3.5) \times 10^{-6} & B_{18} &= 5.15628(38) & D_{18} &= 7.772(52) \times 10^{-3} \\ H_{18} &= 7.6(3.5) \times 10^{-6} \end{aligned}$$

(15) two photon photodissociation, 7 rotational components of $v = 17-14$ band and one component in $v = 15-17$ measured, hfs observed but no hfs constants determined,

$$\begin{aligned} \Delta G &= 1801.315(2) & B_{14} &= 9.2859(8) & D_{14} &= 7.26(12) \times 10^{-3} \\ H_{14} &= 3.65 \times 10^{-6} * & B_{17} &= 6.2837(6) & D_{17} &= 7.40(8) \times 10^{-3} \\ H_{17} &= 2.10 \times 10^{-6} * \end{aligned}$$

* theoretical results for H

HeH⁺

(9) fast ion beam, five transitions involving $v = 0, 1, 2$ measured, no constants determined

(17) fast ion beam photodissociation, two bound to quasibound transitions involving $v = 5, 6, 7$ observed, no constants determined

(18) fast ion beam photodissociation, bound to quasibound transitions measured for three isotopes of HeH⁺: 5 transitions of ⁴HeD⁺ involving $v = 4, 5, 6, 7, 9, 13$; one transition of ³HeD⁺ involving $v = 5, 6, 7$; no constants determined

(31) 9 vibration-rotations measured in the fundamental (0-1) band of HeH⁺ by difference frequency laser spectroscopy of a discharge

$$\begin{aligned} v_0 &= 2910.95681(64) & B_0 &= 33.55841(21) & D_0 &= 1.6210(12) \times 10^{-2} \\ H_0 &= 5.81(15) \times 10^{-6} & B_1 &= 30.83991(18) & D_1 &= 1.5869(10) \times 10^{-2} \\ H_1 &= 5.76(20) \times 10^{-6} \end{aligned}$$

NeH⁺

- (32) 11 transitions of $^{20}\text{NeH}^+$ and 8 transitions of $^{22}\text{NeH}^+$ have been measured for the $v = 1-0$ band by difference frequency laser spectroscopy of a discharge

	<u>$^{20}\text{NeH}^+$</u>	<u>$^{22}\text{NeH}^+$</u>
ω_e	2900(6)	2894(6)
$\omega_e X_e$	111(6)	111(6)
B_e	17.88(2)	17.80(2)
α_e	1.08(4)	1.08(4)
$D_e \times 10^3$	2.704(17)	2.676(19)
$\beta_e \times 10^3$	-0.0235(72)	-0.0232(72)
$r_e (\text{\AA})$	0.9913(6)	0.9913(6)

KrH⁺

- (37) Fourier transform infrared emission spectrum observed in a hollow cathode discharge; unpublished

ArH⁺

- (36) Fourier transform infrared emission spectrum observed in a glow discharge for vibrational states up to $v = 4$ for J values up to 35. The leading Dunham coefficients have been determined:

$$\begin{aligned}
 Y_{10} &= 2710.9191 & Y_{20} &= -61.63075 & Y_{30} &= 0.502654 \\
 Y_{40} &= -0.0010917 & Y_{01} &= 10.461276 & Y_{11} &= -0.378782 \\
 Y_{21} &= 0.0030173 & Y_{02} &= -6.230 \times 10^{-4} & Y_{12} &= 0.08297 \times 10^{-4} \\
 Y_{03} &= 1.584 \times 10^{-8} & Y_{13} &= -0.0459 \times 10^{-8} & Y_{04} &= -0.64 \times 10^{-12}
 \end{aligned}$$

- (37) Fourier transform infrared emission spectrum observed for ArH^+ , ArD^+ ; unpublished analysis

- (48) Mobility of ArH^+ measured in a glow discharge for $v = 0$ and $v = 1$ from Doppler shifts of P(3) - P(6) lines in fundamental band

HCl⁺

- (34) R(8.5) transition of fundamental band observed for X²Π_{3/2} state of HCl⁺ in a glow discharge with a diode laser. No analysis or constants given

CH⁺

- (19) fast ion beam photodissociation spectra measured. Over 78 transitions observed near dissociation limit; no assignments

HCO⁺

- (50) 19 transitions in ν₁ fundamental (R(0) to R(18)) measured by velocity modulation laser absorption. ν₁ = 3088.727(3)
- (69) 10 additional transitions measured in ν₁ P-branch. Improved constants determined:

$$\nu_1 = 3088.73951(31), \quad B_1 = 1.475699(11), \quad D_1 = 2.68(11) \times 10^{-6},$$

$$B_0 = 1.48750974(7)* \quad D_0 = 2.748(2) \times 10^{-6}*$$

* Microwave values referenced above

HNN⁺

- (51) velocity modulated laser absorption, 43 transitions measured in ν₁ fundamental (R(0)-R(19), P(1) - P(23))

$$\nu_1 = 3233.9538(32), \quad B_1 = 1.541429(81) \quad D_1 = 3.07(14) \times 10^{-6},$$

$$B_0 = 1.541429(81), \quad D_0 = 3.11(14) \times 10^{-6}$$

- (61) velocity modulation laser absorption, 48 transitions observed in ν₁ fundamental of DNN⁺ isotope, 70 transitions observed in ν₂ = 1 hot band

$$\underline{(000) \rightarrow (100)} \quad \nu_0 = 2636.983(50) \quad B_{000} = 1.286098(84)$$

$$B_{100} = 1.274535(84), \quad D_{000} = 2.28(12) \times 10^{-6}, \quad D_{100} = 2.17(12) \times 10^{-6},$$

$$(B_{100} - B_{000}) = -0.011563(17)$$

$$\underline{(01'0) \rightarrow (11'0)} \quad \nu_0 = 2618.785(50) \quad B_{010} = 1.29068(11),$$

$$B_{110} = 1.27999(11), \quad D_{010} = 1.98(24) \times 10^{-6}, \quad D_{110} = 1.82(24) \times 10^{-6}$$

$$(B_{110} - B_{010}) = -0.010692(25), \quad (B_{010} - B_{000}) = 0.00458(42),$$

$$q_{010} = 0.2101(11) \text{ GHz}, \quad q_{110} = 0.1892(11) \text{ GHz}, \quad X_{12} = -18.90(10)$$

H₃⁺

- (30a) fundamental of the ν_2 (E-type asymmetric stretch) band measured by difference frequency laser spectroscopy of a glow discharge. 15 transitions measured and fit to a Hamiltonian with 14 molecular parameters:
- $\nu_2 = 2521.564(135)$, $B_1 = 44.051(45)$, $C_1 = 19.689(38)$,
 $(\xi C)_1 = -18.527(50)$, $q = -5.380(74)$, $B_0 = 43.568(48)$,
 $C_0 = 20.708(48)$, $D_J(1) = D_J(0) = 0.047(7)$, $D_{JK}(1) = D_{JK}(0) = -0.099(18)$,
 $D_K(1) = D_K(0) = 0.040(3)$, $q_J = 0.018(5)$
- (10) fast ion beam, 4 transitions measured for the ν_2 fundamental measured, 4 others unassigned; no molecular constants given
- (30b) 15 additional transitions reported for H₃⁺ in ν_2 fundamental, no molecular constants given
- (11) fast ion beam, 9 transitions measured for H₂D⁺ isotope, no assignment given
- (57) Review on H₃⁺, no new molecular constants given
- (20) fast ion beam photodissociation, over 300 lines reported for H₃⁺ from bound and metastable levels near the dissociation limit. No assignments
- (23) fast ion beam photodissociation, ~27,000 lines measured for H₃⁺ from 872 to 1094 cm⁻¹. No detailed assignments made; synthesized low resolution spectrum implies correspondence with J = 2 transitions in H⁺...H₂(V,J) with J = 3 and V varying from 0 to 3. Similar spectra were observed for D₃⁺, HD₂⁺, and H₂D⁺.
- (58) velocity modulation laser spectroscopy, 41 transitions measured in the $2\nu_1 - \nu_2$ band, over half of these occur in stimulated emission, no analysis available.

- (56) velocity modulation laser absorption, 150 transitions measured in v_3 fundamental and analyzed with S-reduced Hamiltonian, $v_3 = 3334.6718(32)$
- (56) velocity modulation laser absorption, over 300 transitions measured in v_1 and v_3 fundamentals and analyzed with S-reduced Hamiltonian

	(0, 0, 0)	(0, 0, 1)	(1, 0, 0)
v_0		3334.6895(26)	3348.7078(36) ^a
A	34.5110(14)	33.1985(15)	33.9131(28)
B	12.88518(24)	12.66161(24)	12.59785(33)
C	9.08015(22)	8.90609(16)	8.89164(21)
$D_J \times 10^3$	0.9533(33)	0.9661(13)	0.9197(22)
$D_{JK} \times 10^3$	-6.759(43)	-6.854(44)	-6.04(11)
$D_K \times 10^3$	77.65(15)	71.55(14)	92.59(73)
$d_1 \times 10^3$	-0.38992(80)	-0.39665(89)	-0.3917(13)
$d_2 \times 10^3$	-0.05003(50)	-0.04987(58)	-0.0567(11)
$H_J \times 10^6$	0.059(17)	*	*
$H_{KJ} \times 10^6$	-105.3(4.5)	-66.3(3.5)	-111(20)
$H_K \times 10^6$	46.3(2.1)	*	1788(87)
$L_{KJ} \times 10^6$	-3.24(17)	-0.652(69)	-4.64(96)
$L_K \times 10^6$	*	*	44.0(3.6)
$S_{KJ} \times 10^9$	43.9(2.4)	*	*

^a Numbers in parenthesis are one standard deviation

* These parameters were constrained to zero



- (6) low resolution gas phase study of $\text{H}_3\text{O}^+ \cdot n\text{H}_2\text{O}$
- (52) velocity modulation laser absorption, 60 transitions measured in ν_3 (E asymmetric stretch) fundamental.

Symmetric $^* \nu_3' = 3530.165(55)$, $B' = 11.00(11)$, $B'' = 11.23(11)$,
 $C'(1-\xi) = 5.60(11)$, $(C'-B')-(C''-B'') = 0.199(8)$,
 $C'' = 6.14(11)$, $C' = 6.11(11)$

Asymmetric $^* \nu_3' = 3513.840(47)$, $B' = 10.788(36)$, $B'' = 10.957(36)$,
 $C'(1-\xi) = 5.693(36)$, $(C'-B')-(C''-B'') = 0.132(7)$,
 $C'' = 6.177(36)$, $C' = 6.140(36)$

$$r_{\text{OH}} = 0.979(6) \text{ \AA} \quad \angle_{\text{HOH}} = 114.91(45)^\circ$$

$$^* \nu' = \nu_0 + C'(1-2\xi) - B'$$

- (63) velocity modulation laser absorption, 32 transitions measured in ν_2 fundamental (umbrella mode).

$$\nu_0 = 954.417(14)$$
, $B_1 = 10.690(4)$, $B_0 = 11.253(4)$,
 $(C_1 - B_1) - (C_0 - B_0) = 0.694(15)$, $D_J(1) = 1.8(2) \times 10^{-4}$,
 $D_J(0) = 13(1) \times 10^{-4}$, $D_{JK}(1) = -1.9(1) \times 10^{-4}$,
 $D_{JK}(0) = -30(4) \times 10^{-4}$, $D_K(1) - D_K(0) = -20(10) \times 10^{-4}$

- (62) velocity modulation laser absorption, over 380 transitions measured for ν_3 fundamental of D_3O^+ isotope. No analysis available.



- (54) velocity modulation laser absorption, 73 transitions in ν_3 (F-type asymmetric stretch) fundamental measured. Preliminary analysis
- (53) velocity modulation laser absorption, 21 transitions measured in ν_3 fundamental, preliminary analysis
- (55) velocity modulation laser absorption, over 200 transitions in ν_3 fundamental measured and analyzed with an effective 6th order Hamiltonian. 26 parameters determined.

$$\nu_3 = 3343.1399(21)$$
, $B_3 = 5.79904(18)$, $B_0 = 5.852$, $D_0 = 1.20 \times 10^{-4}$,
 $D_T = -t_{044} = 5.53 \times 10^{-6}$, $2B\xi_3 = 0.55495(40)$, $\alpha_{220} = -2.83(13) \times 10^{-3}$,
 $\alpha_{224} = -4.164(15) \times 10^{-3}$, $D_3 = 33.4(4.4) \times 10^{-6}$. See reference for remaining parameters.

HCNH⁺

(60) velocity modulation laser absorption, 27 transitions measured
in ν_2 (CH-stretch)

$$\nu_2 = 3187.86382(39), B'' = 1.236067(32), D'' = 1.640(115) \times 10^{-6},$$

$$B' = 1.228493(30), D' = 1.632(92) \times 10^{-6}$$

FIGURE CAPTIONS

- Figure 1. The first microwave Doppler shift measurements of an ion in DC plasma: the $J = 1 \leftarrow 0$ transition for HCO^+ by Woods et al. (42). $P > 0$ corresponds to microwave propagation parallel to the ion drift velocity, whereas $P < 0$ corresponds to antiparallel propagation.
- Figure 2. The second generation of Doppler shift measurements by Woods and co-workers (47). Top curves: copropagating, bottom curves: counter propagating, $\bigcirc = 300$ mA, $\Delta = 150$ mA discharge currents.
- Figure 3. Doppler shift spectrum of the P(5) fundamental transition of ArH^+ at $2479.4113 \text{ cm}^{-1}$ Be etalon transmission curve (FSR = 1420 MHz) (top), Red-shift (middle), and blue-shift (bottom) spectra. The unshifted line is neutral Ar. From Haese, Pan and Oka (48).
- Figure 4. Schematic of the Color Center Laser - velocity modulation spectrometer of Saykally and co-workers (50,51). A. S. = Amplitude Stabilizer, S. A. = Spectrum Analyzer, CCL = Color Center Laser
- Figure 5. The velocity modulation spectrum of HNN^+ . The strong R(1) ν_1 fundamental transition shown here has been clipped ($\div 10$) in order to clearly reveal the $\nu_2 = 1'$ hot band -doublet and typical noise amplitude. From Gudeman, and Saykally (to be published).
- Figure 6. Reconstructed spectrum of the ν_3 band of H_3O^+ measured in LN_2 cooled H_2/O_2 plasmas. From Begemann, et al. (52). In the assignment the dashed lines correspond to the asymmetric inversion band, the solid to the symmetric.

Figure 7. Bandhead of the R_{21} branch in the $CO^+ A^2\Pi_{1/2}(v=1) \leftarrow X^2\Sigma^+(v=0)$ system. Numbers in the assignment are the N (pure rotation) quantum number. The approximately half of the unassigned transitions are due to N_2 impurities (high v $B \leftarrow X N_2^+$); the remainder are likely due to $X(\text{high } v) \leftarrow X(v=0) CO^+$ transitions which borrow intensity from the A state. From Matrner, et al. (67).

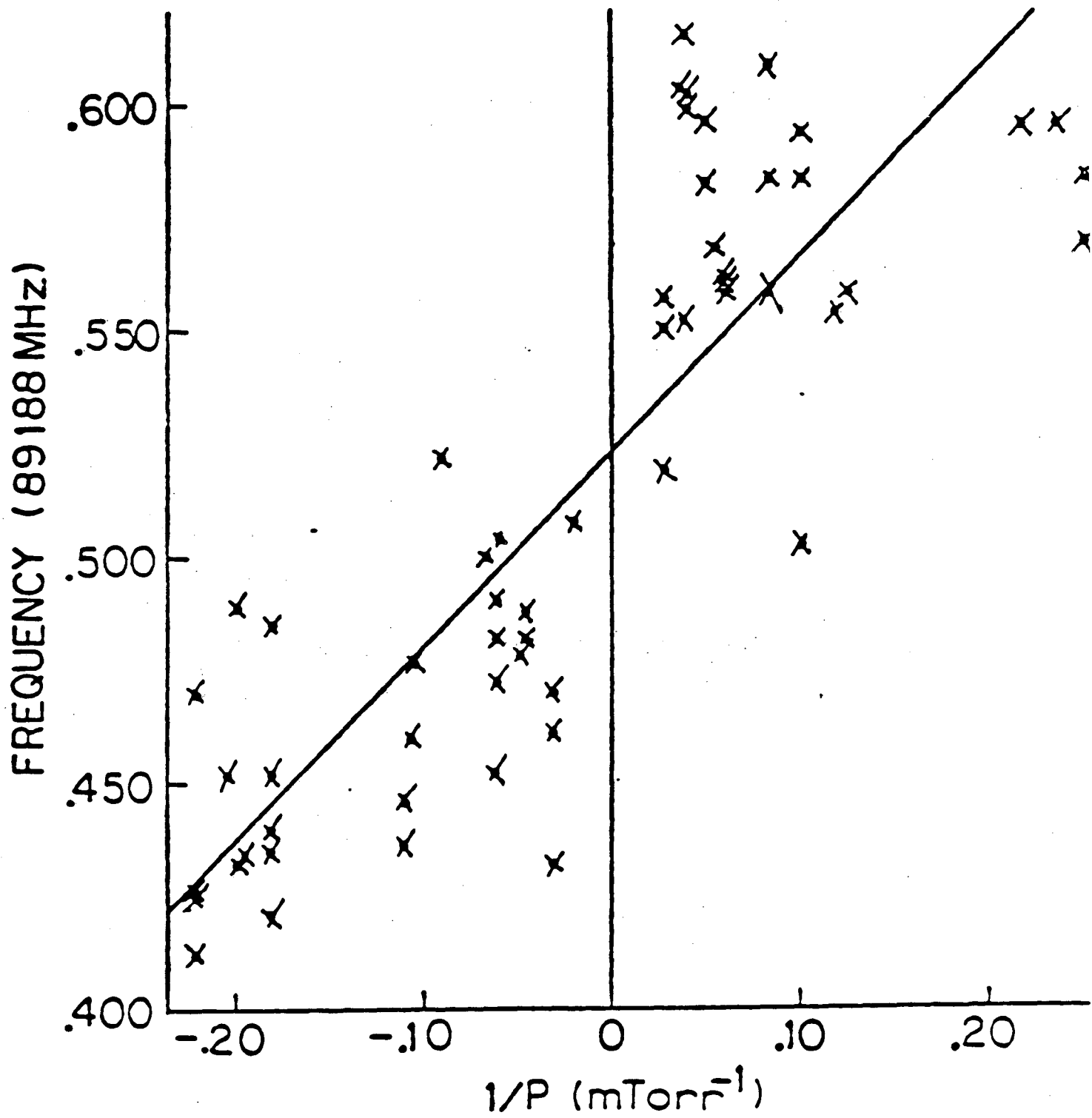

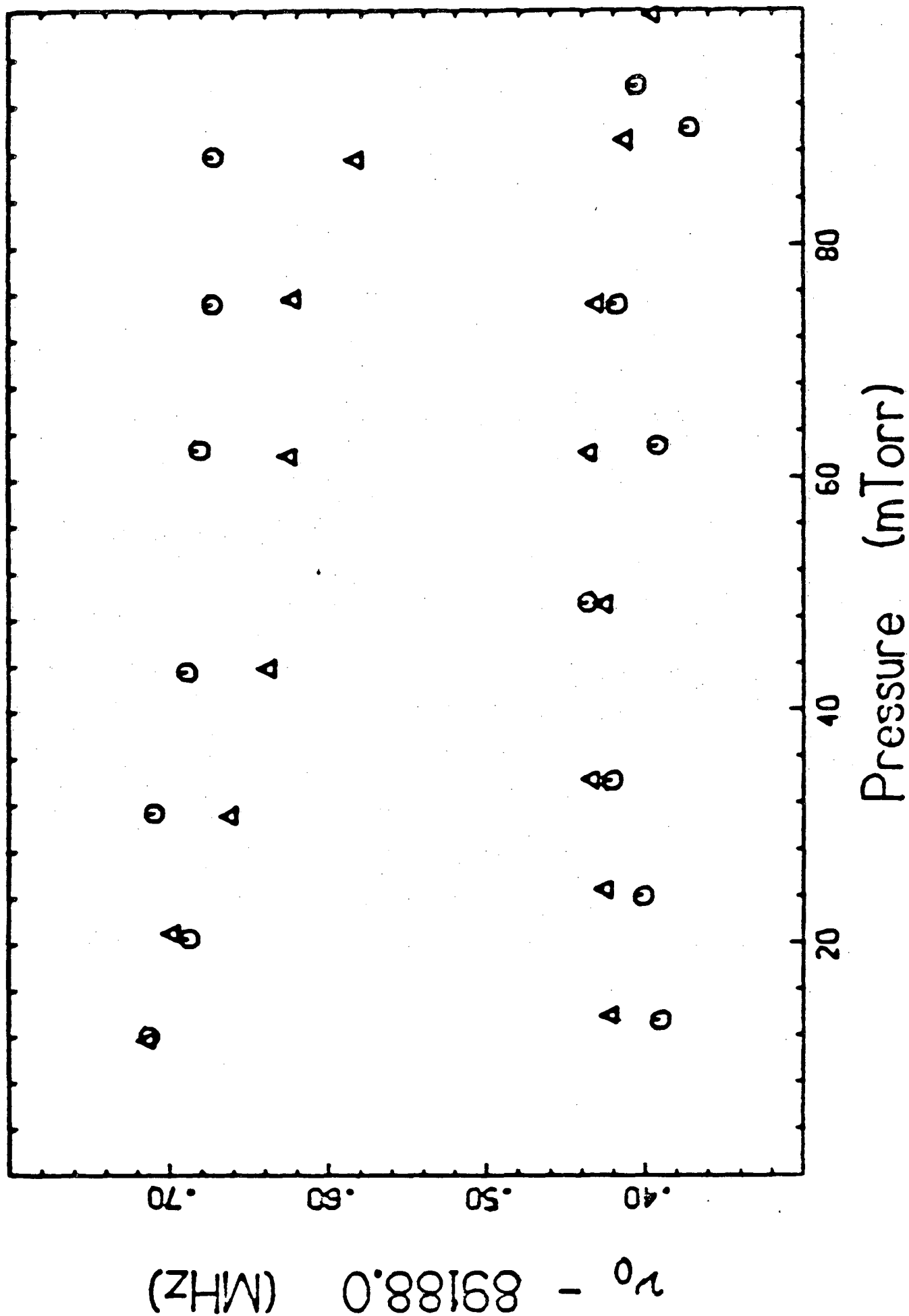



↔ 254 MHz

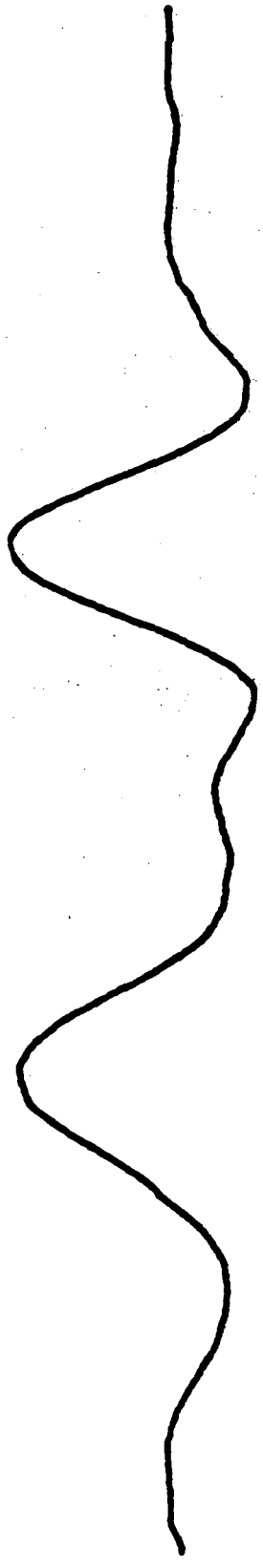

Ar

ArH⁺

V →

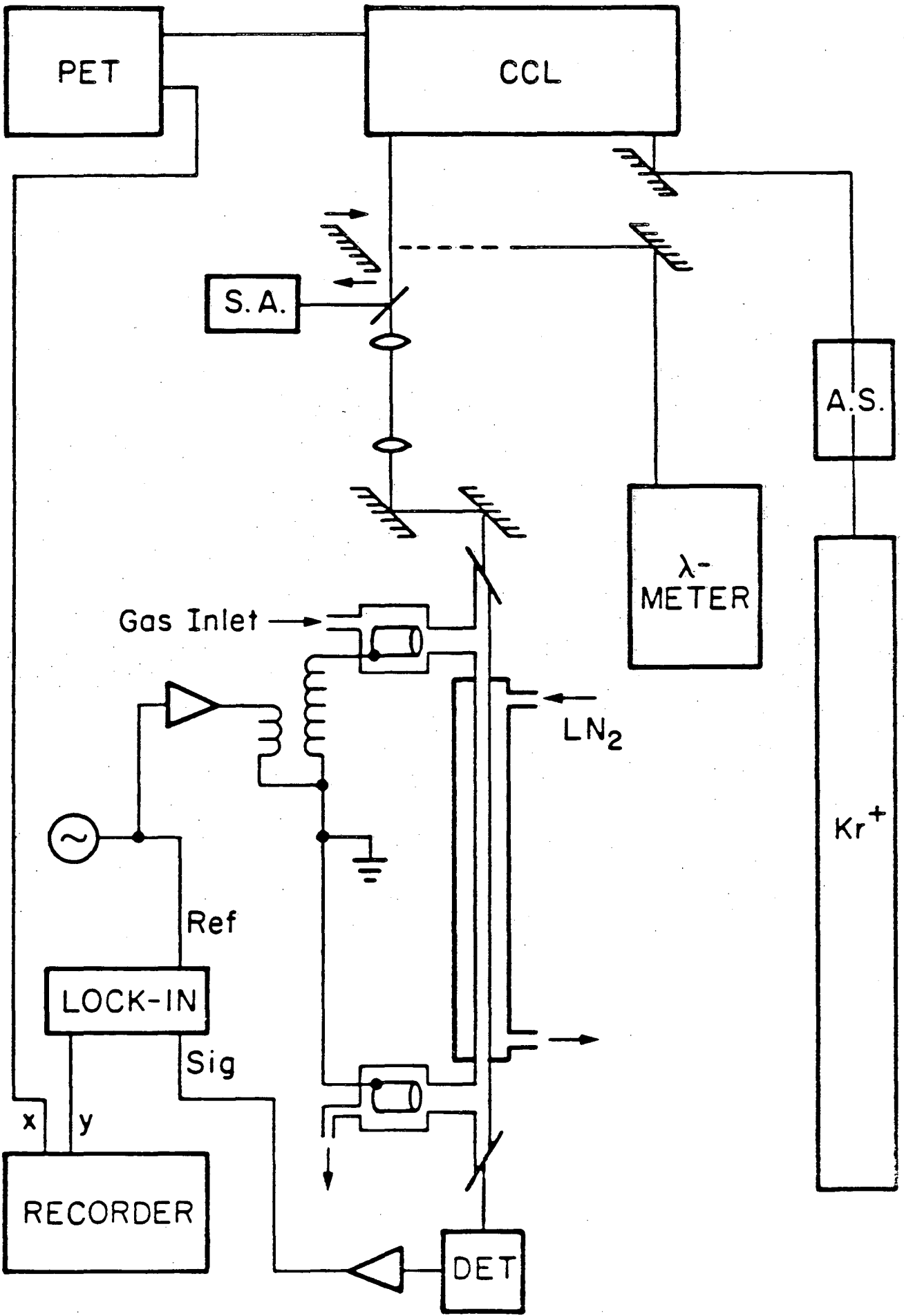

HNN⁺

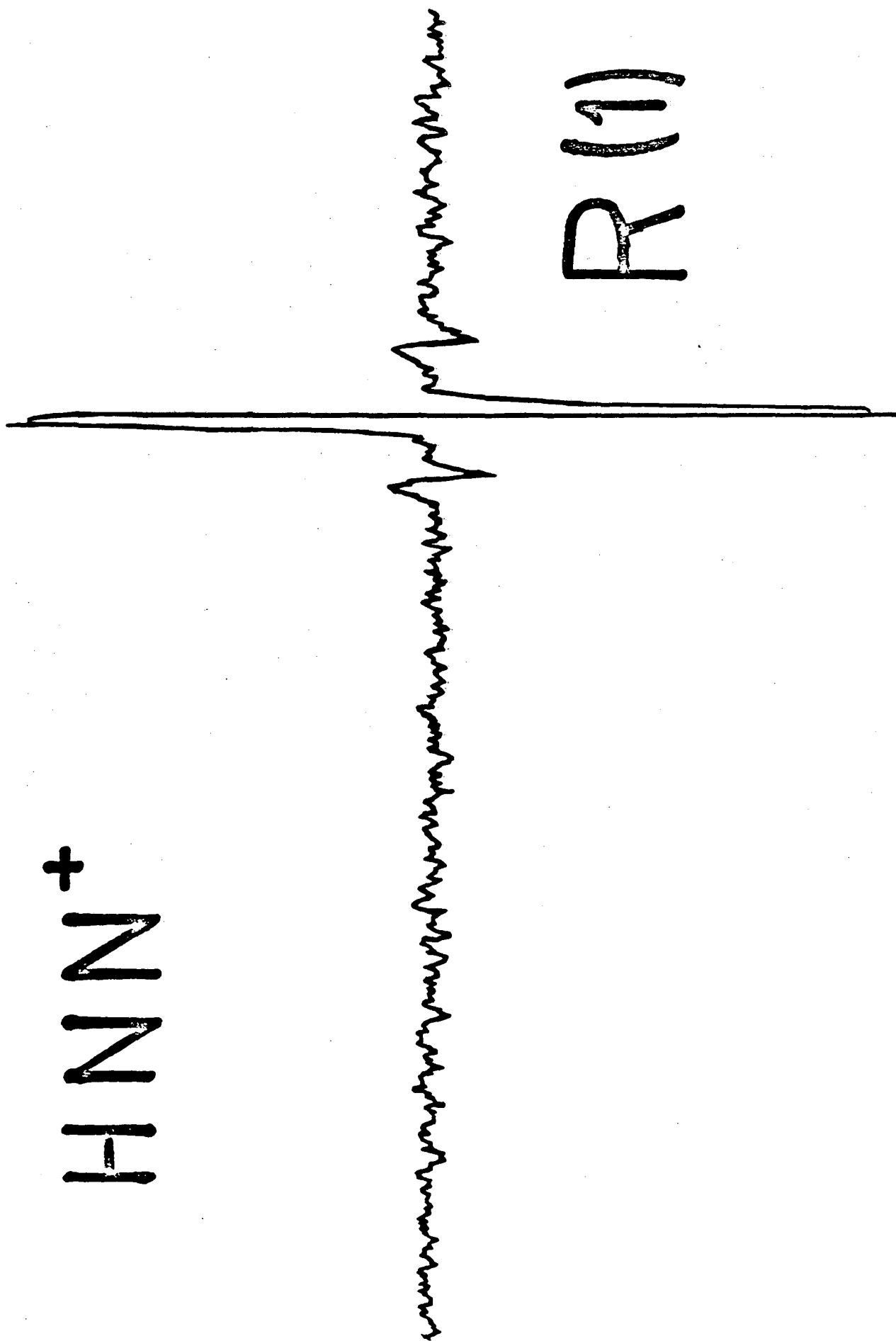

R(1)

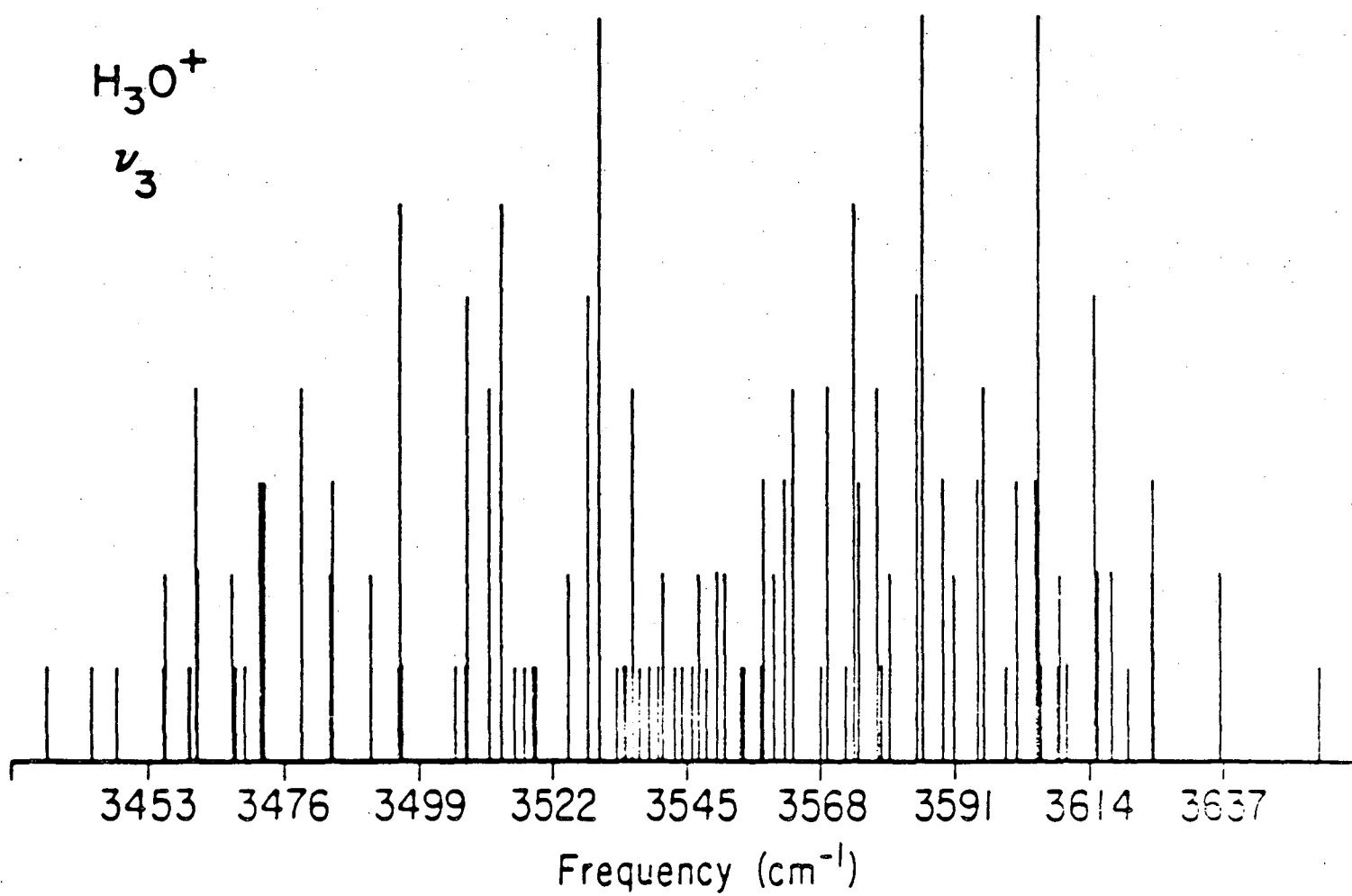
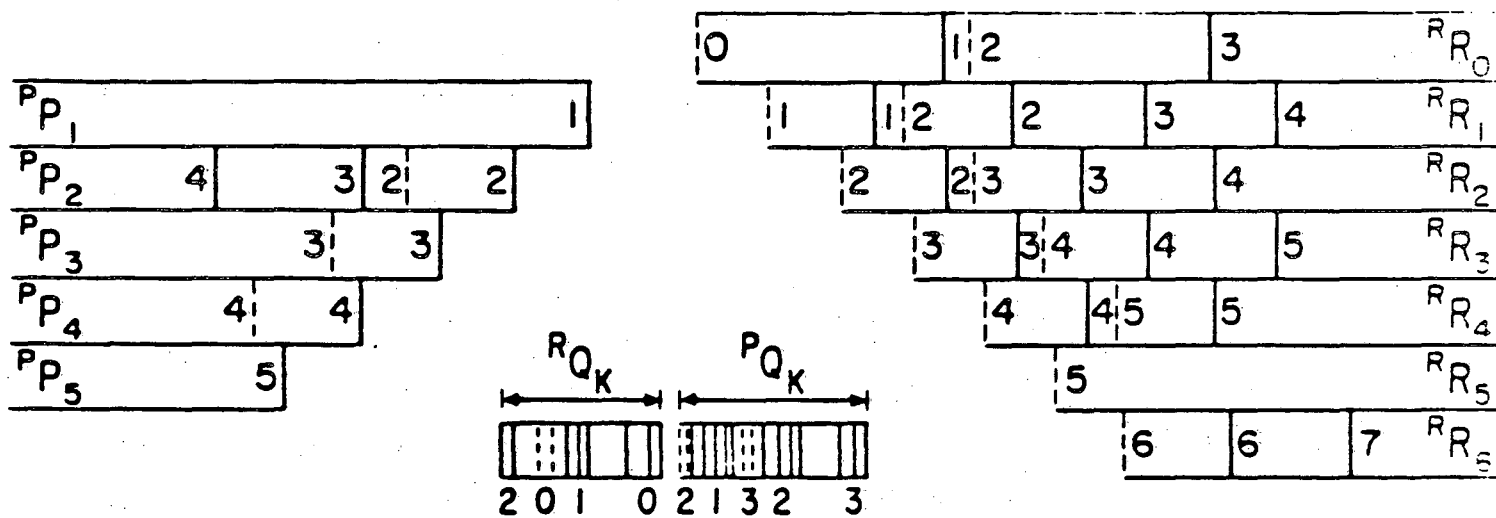

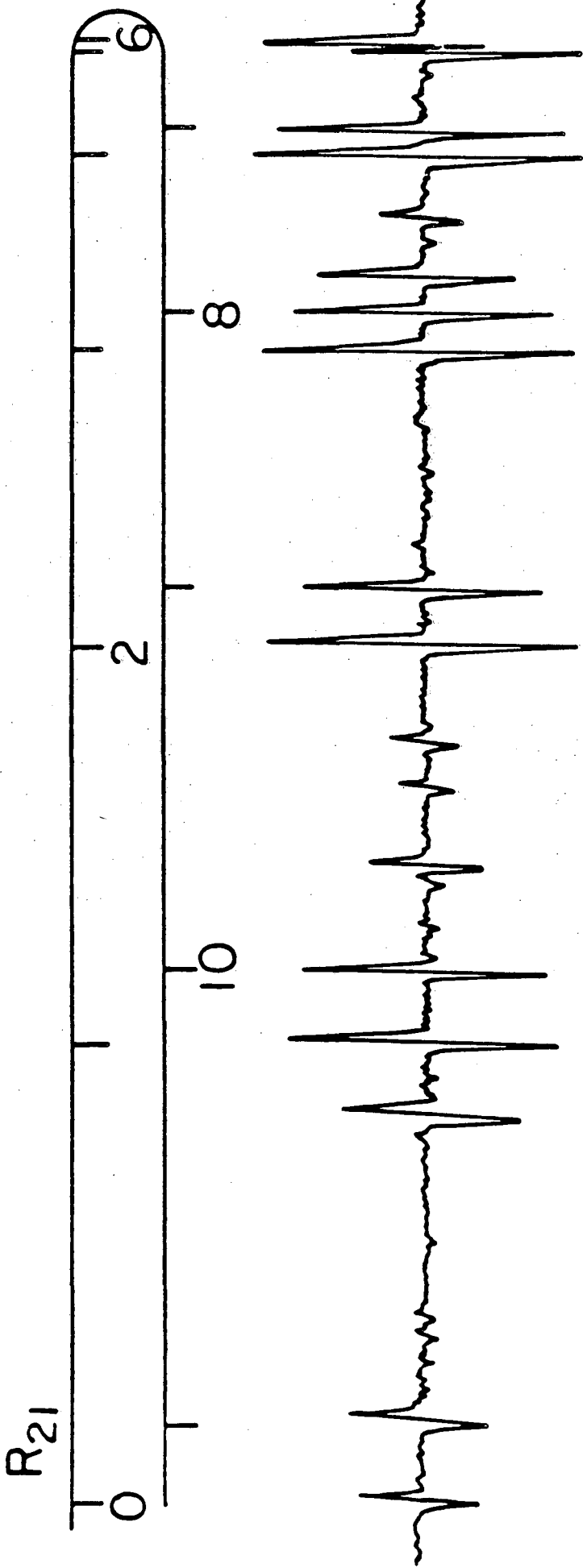

1 cm⁻¹

This report was done with support from the Department of Energy. Any conclusions or opinions expressed in this report represent solely those of the author(s) and not necessarily those of The Regents of the University of California, the Lawrence Berkeley Laboratory or the Department of Energy.

Reference to a company or product name does not imply approval or recommendation of the product by the University of California or the U.S. Department of Energy to the exclusion of others that may be suitable.

TECHNICAL INFORMATION DEPARTMENT
LAWRENCE BERKELEY LABORATORY
UNIVERSITY OF CALIFORNIA
BERKELEY, CALIFORNIA 94720