

VOLTAGE REGULATION OF WIND INDUCTION GENERATOR

Babaria Pritul¹, Swaati Sawaikar², Dr. Umashankar S³

1School Of Electrical Engineering, VIT University,
Vellore-632014, Tamil Nadu, India

bp745746@yahoo.com ; umashankar.s@vit.ac.in

Abstract. This project focuses on how to reduce the voltage variations, on a self-excited induction generator, which is caused due to variations in load. A real time model of such a circuit is simulated using MATLAB/Simulink and the changes in voltage for many different resistive loads are recorded. The voltage control is achieved adding series capacitors. This control strategy is implemented using MATLAB/Simulink.

Keywords: Induction generator, Regulation, Simulink, Reactive power,

1 Introduction

Recent emphasis on the use of clean and renewable energy sources to reduce dependency on fossil fuels makes the use of SEIG even more attractive because vast amounts of renewable energy sources like wind and mini hydro are available in village areas. SEIGs are widely used to extract power from non-conventional sources of energy like in wind farm and mini hydro - electric power generation scheme. Self-excited induction generators are ideal for an isolated power system supply the power to the remote areas electrification, because it does not require much maintenance; it less costs and has rugged rotor construction. SEIGs have certain advantages over the conventional synchronous generators. One of the main advantages is that SEIGs have better overload protection in case of a fault. The excitation limits the fault current and the voltage immediately reduces.

Inspite of offering so many advantages, SEIGs have poor voltage regulation. As load keeps varying, the voltage regulation gets poorer. Its inability to maintain a good voltage regulation is its prime disadvantage. Various methods were proposed over the years to overcome poor voltage regulation. Static VAR compensators (SVCs), which use thyristors or IGBTs, STATCOMs, which are based on DC-AC converters, are used for this purpose. But the main disadvantage of such methods is their complexity and low reliability because of power electronic circuits that inject harmonics in the line current.

The most attractive method would be addition of series capacitors, which doesn't include any power electronic circuits. So this method provides lesser harmonics, simpler design, lower cost and higher reliability. It is also easier to maintain

A simple method of selecting the values of fixed and switched capacitors in the circuit (short shunt configuration) driven by a regulated prime mover to maintain the load voltage within upper and lower limits is proposed in the next section.

An SEIG has poor regulation that restricts the capability of the machine. Unlike synchronous generators, an SEIG is unable to supply reactive power to the load. In fact, it absorbs reactive power from external sources like grid supply or external capacitor banks. The reactive power demand mainly depends on its loads. If terminal voltage is kept constant, the reactive power consumption of this generator is increase with increase of active power delivery. In a case where the excitation capacitor is kept constant, the voltage decreases with increase in active power delivery. As a result, the reactive power supplied by the capacitor is less than required. This leads to further decrease in voltage. This is the reason why an SEIG has poor regulation for unity power factor loads.

2. Concept of voltage regulation in SEIG

As mentioned above, a control strategy is discussed. The value of capacitors is chosen such that the number of switched capacitors needed for maintain the voltage is minimum. This reduces the cost and the complexity of the operation. We know that an induction motor when driven by an external prime mover, can works as a generator. A proper rating of capacitor bank is connected across its stator terminals. Such a machine is called a self-excited induction generator (SEIG).

Requirements of the customer demand the generator to operate within a narrow range of voltage tolerance band. If we use the same value of capacitance, there will be considerable variation in the terminal voltage level. In most of the cases, the peak of the generator output lies outside the voltage tolerance band. Therefore, the maximum power capability of generators cannot be utilised. The power at which voltage falls to the minimum permitted level is called the maximum usable power.

This short shunt scheme is more effective in voltage regulation for higher loads. This uses series capacitive compensation. When load current increases, the current passing through the series capacitance will also increase. More magnetizing reactive power is furnished to the machine and the voltage drop with load will be less severe than the simple shunt compensation.

3. MODELLING OF SEIG WITH SERIES COMPENSATION

SEIG's prime mover is generally driven either by wind, it finds its application in remote area as a stand alone system. Three phase shunt capacitors are used to excite the stator windings of the generator. Design procedure primarily requires the calculation of the value of shunt capacitors. The calculation for minimum and maximum capacitance required to excite the machine is presented [3]. Secondly, we need value of the series capacitor required to control the voltage dip explained previously in section -3. In earlier reported work mostly to inject VAR into the system by using shunt connected devices. However, this paper describes series connected device for voltage improvement, therefore we are using switched series capacitor to increase the reactive power of the line.

The circuit, for a three-phase short shunt induction generator, Fig. 1. The following parameters in the circuit represent:

- X_{sc} stator leakage reactance
- R_s stator resistance
- X_r rotor leakage reactance
- R_r rotor resistance
- X_{sc} series reactance
- X_{sh} shunt reactance
- Z_l load impedance

When generator operates at a speed other than the synchronous speed all inductive reactance are to be multiplied by frequency f and all capacitive reactance are to be divided by frequency f. Also, the voltages should be divided by frequency whereas the current remains same. All the parameters are constant except the magnetizing reactance X_m, which is the main factor in the process of voltage build up and the stable point of operation of a SEIG. The relation between E_g/f and X_m is established. The relation is given by

$$E_g/f = k_1 - k_2 * X_m \quad (1)$$

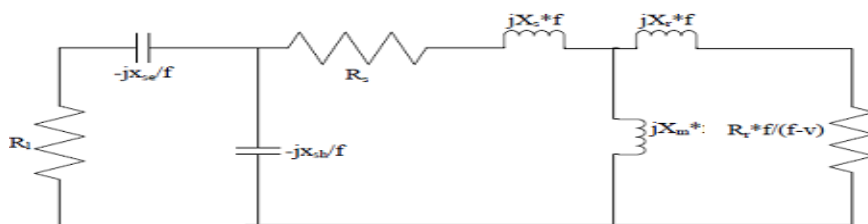

Fig.1 Single-phase steady state equivalent circuit of self-excited induction generator

The steady state analysis of induction generator is done by dividing the above circuit in three sections Z_1 , Z_2 , Z_3

Where,

$$Z_1 = R_s + (j * X_s * f) \quad (2)$$

$$Z_2 = (j * f * X_m) * ((R_r * f / (f - v)) + (j * X_r * f)) / (R_r * f / (f - v) + (j * f * (X_m + X_r))) \quad (3)$$

$$Z_3 = (-j * X_{sh} / f) * (R_L - (j * X_{se} / f)) / (R_L - ((j * X_{sh} / f) + (j * X_{se} / f))) \quad (4)$$

The eq. for loop is

$$I_s (Z_1 + Z_2 + Z_3) = 0 \quad (5)$$

During normal operation of generator the stator current is never zero and therefore

$$(Z_1 + Z_2 + Z_3) = 0$$

the above equation can be written by separating the real and imaginary parts to get

$$G_1 = \text{real} (Z_1 + Z_2 + Z_3) = 0 \quad (6)$$

$$G_2 = \text{imag} (Z_1 + Z_2 + Z_3) = 0 \quad (7)$$

Number of unknowns in the above eq. are six (X_m , X_{sh} , X_{sc} , Z_l , f , v). However solving two equation can give solution only when there are two variable. So we solve for given values of X_{sh} , X_{sc} , Z_l , v and obtain values of X_m and f .

Knowing the values of X_m and f the generated voltage E_g can be evaluated using the equation 1. Knowing the value of E_g , V_t can be found as:

$$V_t = E_g * Z_3 / (Z_1 + Z_3) \quad (8)$$

Also the other parameters of the machine can be found, after the evaluation of X_m and f , like power output, load voltage, stator current, rotor current, load current.

$$I_s = V_g / (Z_1 + Z_l Z_{ch} / (Z_l + Z_{ch})) \quad (9)$$

$$I_r = V_g / (R_r * f / (f - v) + j f X_r) \quad (10)$$

$$I_l = I_s * Z_{ch} / (Z_l + Z_{ch}) \quad (11)$$

$$V_l = I_l * R_l$$

$$P_{out} = 3 * I_l^2 * R_l$$

Where Z_{ch} is impedance of shunt capacitor which is given by

$$Z_{ch} = -j * X_{sh} / f$$

3.1 ALGORITHM FOR SELECTION STRATEGY OF CAPACITOR.

1. Read machine data such as R_s , R_r , X_s , X_r , R_l , etc.
2. Assume initial values of X_m and f .
3. Set the iteration for the power counter.
4. Apply any method to solve X_m and f using any iterative method.
5. Calculate the voltage deviation.
6. Select value of shunt capacitance as in [2].
7. Select value of series capacitance from the graph between regulation and series capacitance values.
8. Run the iterations till the convergence point is reached.
9. Then run the iterations for various capacitance values for series and shunt values.
10. When the voltage deviation is optimum i.e. around 2%, then we can say that the selection is proper.
11. Calculate the other performance parameters which are necessary in the analyses.

4. RESULTS AND SIMULATION

The schematic diagram for the simulation of a SEIG with switched series capacitors is shown below. The induction generator is a three phase, 4 pole, 1430 rpm, 2.2kw, 415v star connected squirrel cage machine. As we have already discussed, first we see the variation in voltage with addition of load and then in the next part we add series capacitor to overcome the poor regulation. The voltage regulation for any system is given by

$$V\% = (\text{change in voltage from no load to full load/full load voltage}) * 100$$

4.1 Voltage regulation with addition of load

The induction machine is given a constant torque of 13.8 Nm and the series capacitor is not included during in this part because we are interested in knowing the drop in voltage w.r.t load. So now we load the induction generator, by decreasing the resistance the current drawn increases and thus it is loaded. The machine is loaded with different load and drop in the voltage is found to get the regulation. All these data are tabulated as shown below.

Table 1 Load test of a 3-Ø stand-alone operated SEIG

S.No	Load Current	Load Voltage	Voltage
1	3.76	391	5.78
2	4.5	312	24.8
3	5.14	266	35.9
4	6.18	215	48.19

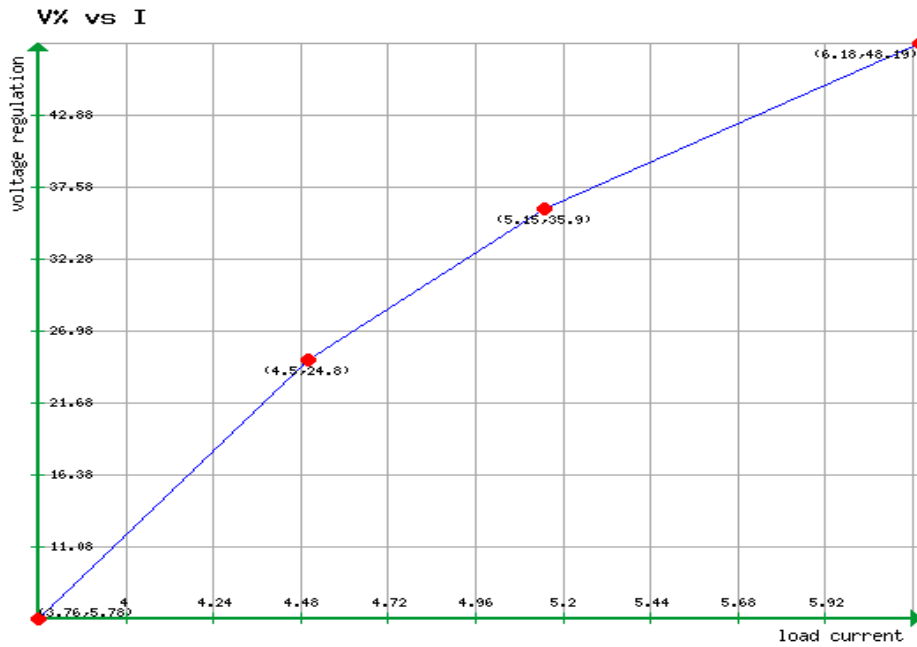

Fig.2 Regulation versus load current

Voltage graphs for different load condition are shown below

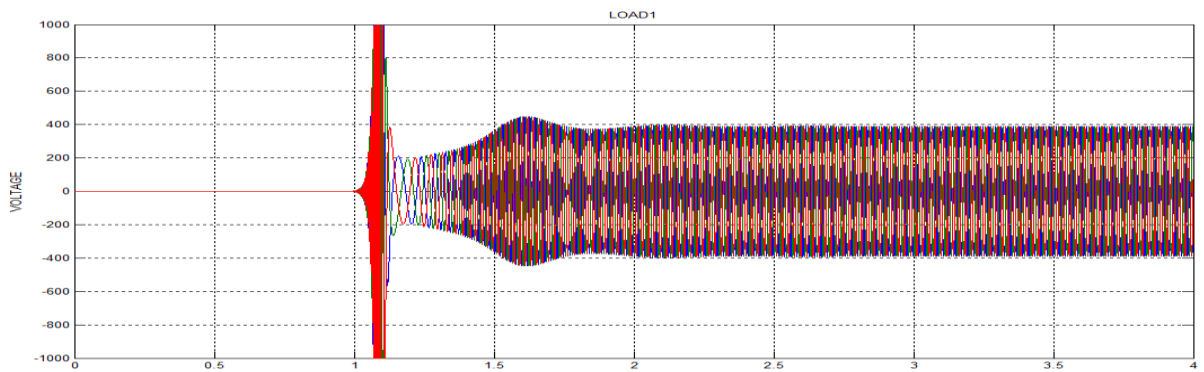
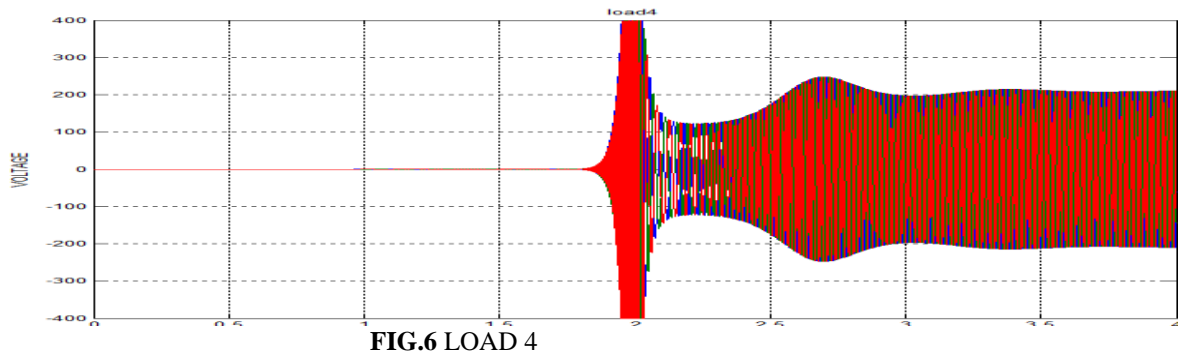
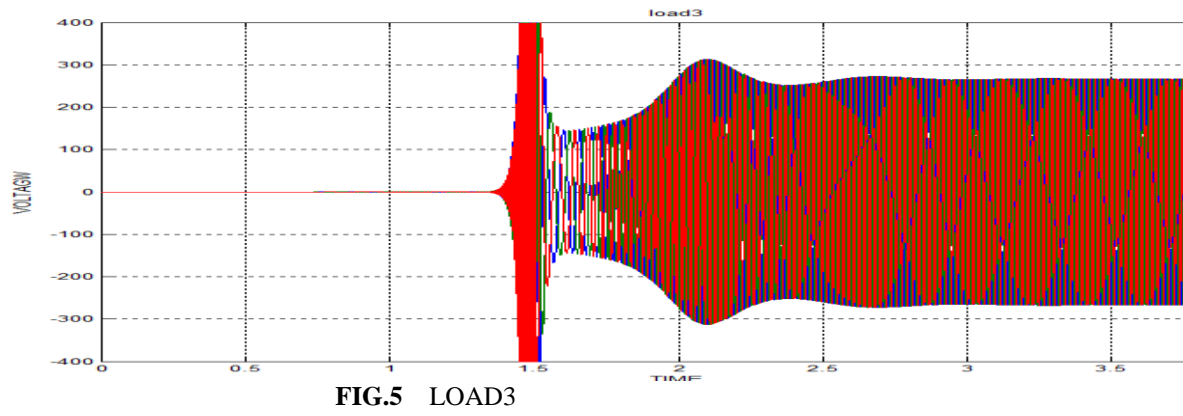
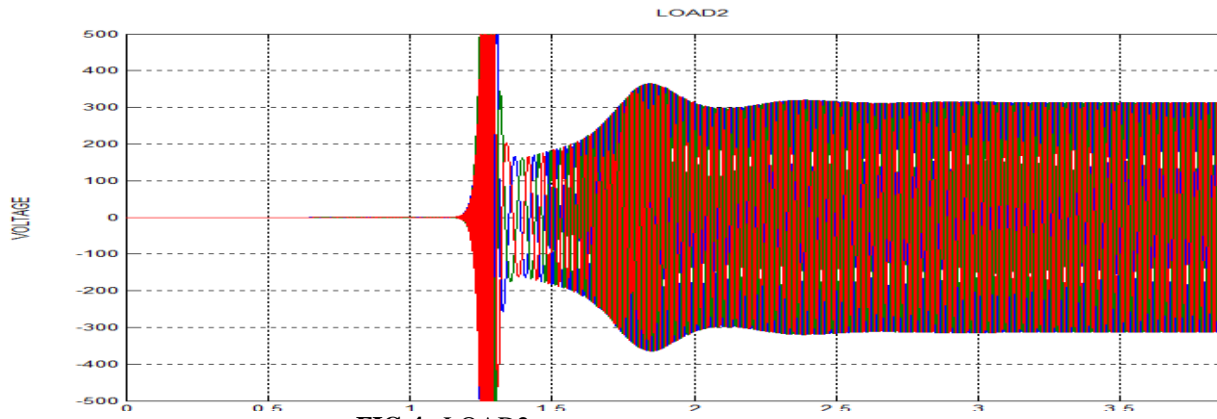

FIG.3 LOAD1



Here we have $load4 > load3 > load2 > load1$ and it is clearly seen that voltage drop increases with increase in the load. A simple method of switched capacitor is used to control the drop in voltage in next section.

4.2 Voltage regulation using series capacitors

We have already seen the loading of the machine in the above section that SEIGs have very poor voltage regulation. Therefore, we now add series capacitor to improve the voltage of a three phase induction machine. This is because when the load increases the current through the series capacitor increases and more magnetizing reactive power is supplied and hence the voltage drop gets reduced when compared to simple SEIG.

Again the same machine is given a constant torque of 13.8 Nm. For each value of load the capacitance required to achieve voltage regulation within 2% is calculated. All the data is then tabulated and their respective graphs are shown.

MATLAB diagram of SEIG with series capacitor is shown below:

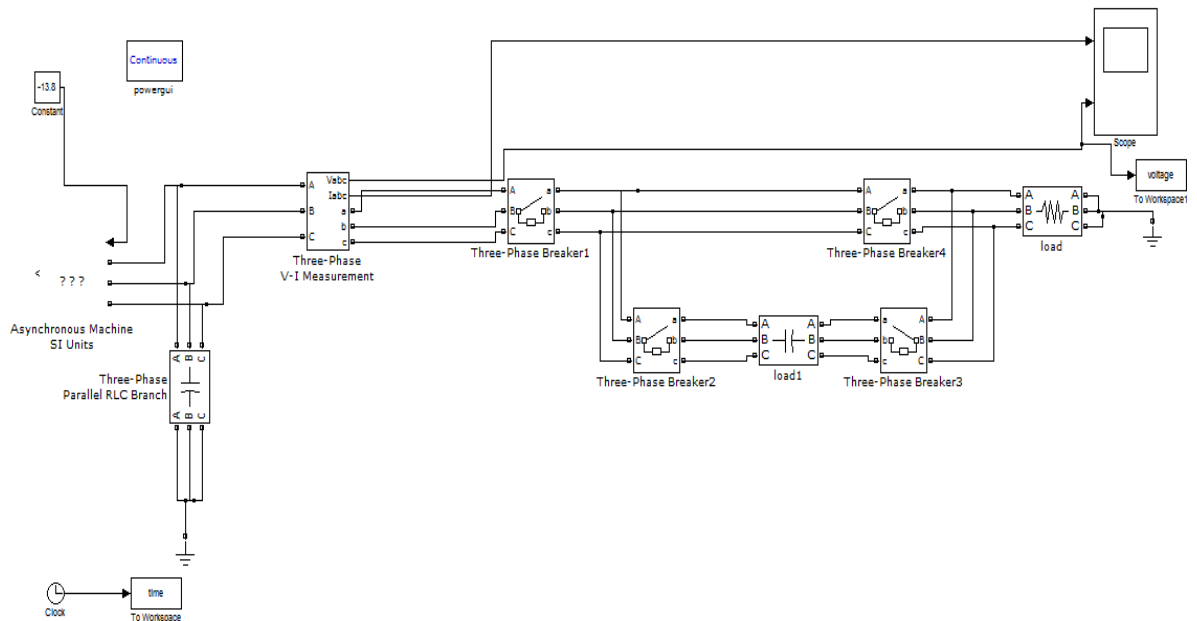

FIG.7 MATLAB MODEL

Change in voltage after adding the capacitor can clearly be seen in the figure below for all the loads in above section:

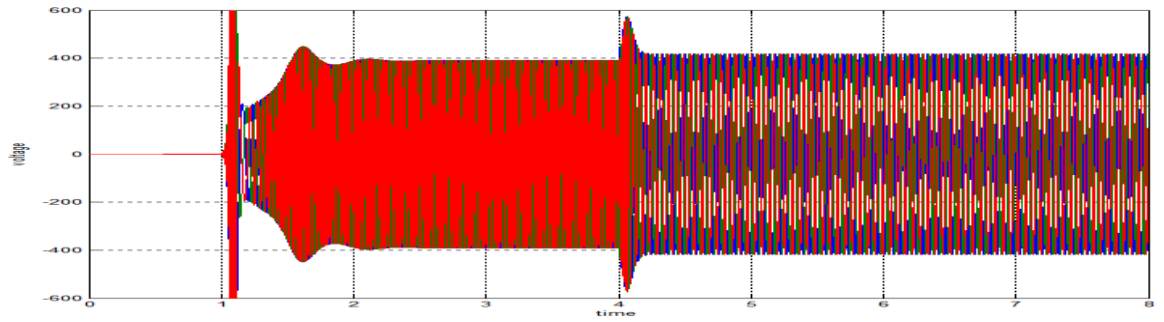

FIG.8 LOAD 1 with series cap. C1

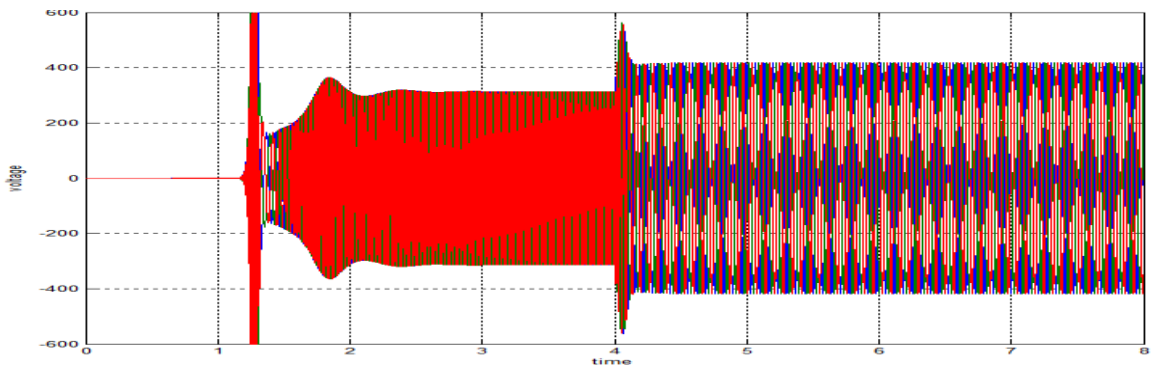

FIG.9 LOAD2 with series cap. C2

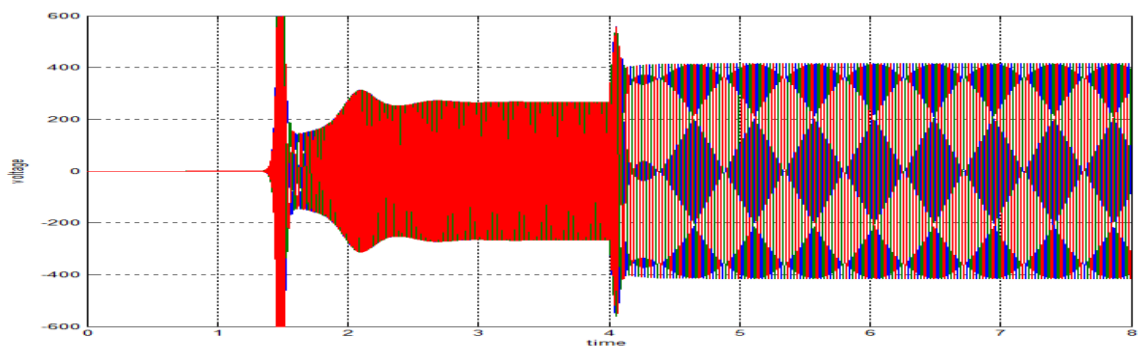

FIG.10 LOAD3 with series cap. C3

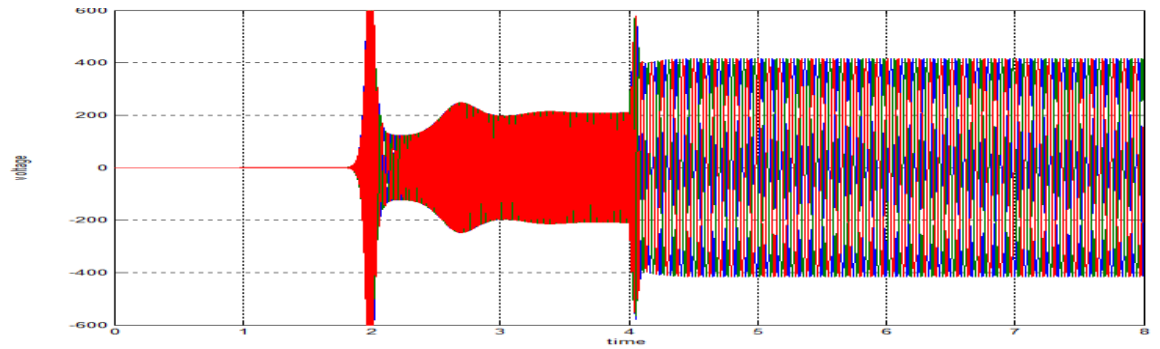

FIG.11 LOAD 4 with series cap. C4

The capacitor's values for respective loads were calculated for all the loads mentioned in the above section and their regulation is improved which can clearly be seen in the table below:

S.No	Series capacitor	Voltage Without Xsr	Voltage with Xsr	Regulation
1	C1=12e-5	391	417.5	.62
2	C2=13.6e-5	312	418	.72
3	C3=15.4e-5	266	417	.48
4	C4=18e-5	215	417	.48

From the obtained data we can conclude that with increase in the load demand the requirement for the real power increase causing voltage drop, which can be overcome using series capacitor.

5. CONCLUSION

This paper presents a simple method to improve the voltage regulation of the simple SEIG. SEIGs under changing load condition have very poor voltage regulation so series compensation method is used to improve the regulation when the excitation capacitance is kept constant. The circuit for the same is designed using MATLAB/Simulink and evaluated. The proposed model is for a 2.2kw 415V 1430 rpm asynchronous machine. It is observed that the voltage regulation without series capacitor is very high but with a proper selection of the excitation capacitors and series capacitors it decreases and is seen that the performance is highly enhanced.

6. REFERENCES

- [1] Subramanian Kulandhaivelu, K. K. Ray, P Jyothi, S Jayachitra, and V Narasinga Rao, "Experimental evaluation of capacitance value; to self-excite the induction motor operating as generator in wind energy conversion" IEEE International conference on ICETECT 2011, pp 133-140.
- [2] Somesh Bhattacharya. "Selection of Capacitors for Compensated Self-Excited Induction Generator using Meta-Heuristic Approach."
- [3] Subramanian Kulandhaivelu. "*LOAD CONTROL OF A 3-Ø SELF-EXCITED ASYNCHRONOUS GENERATOR*"
- [4] B.L. THERAJA "ELECTRICAL MACHINES"
- [5] C.Grantham,F.Rahman,D.Seyoum "ASelf Excited Induction Generator with Voltage Regulation for use in a Remote Area Power Supply."