

# Voltage Stability Prediction on Power Networks using Artificial Neural Networks

Gitanjali Saha, Kabir Chakraborty, Priyanath Das

Tripura Institute of Technology, Narsingarh, Tripura, India

---

## Article Info

### Article history:

Received Jan 9, 2018

Revised Mar 2, 2018

Accepted Mar 18, 2018

---

### Keywords:

Artificial neural network  
(ANN)

Contingency analysis

Critical bus

FACTS devices

Voltage security

---

## ABSTRACT

The objective of this paper is to predict the secure or the insecure state of the power system network using a hybrid technique which is a combination of Artificial Neural Network (ANN) and voltage stability indexes. Voltage collapse or an uncontrollable drop in voltage occurs in a system when there is a change in the condition of the system or a system is overloaded. A Transference Index (TI) which acts as a voltage stability indicator has been formulated from the equivalent two-bus network of a multi-bus power system network, which has been tested on a standard IEEE 30-bus system and the result is validated with a standard Fast Voltage Stability Index (FVSI). FACTS devices in the critical bus have been considered for the improvement of the voltage stability of the system. An ANN based supervised learning algorithm has been conferred in this paper alongside Contingency Analysis (CA) for the prediction of voltage security in an IEEE 30-bus power system network.

*Copyright © 2018 Institute of Advanced Engineering and Science.  
All rights reserved.*

---

### Corresponding Author:

Gitanjali Saha,

Tripura Institute of Technology,

Narsingarh, Tripura, India.

Email: gitanjali\_nit@yahoo.co.in

---

## 1. INTRODUCTION

The operation of the power utilities can achieve its efficiency and reliability if the following objectives are satisfied [1] :

- Minimization of the reactive power flow so that the resistive and reactive losses are reduced.
- The stability of the system should be enhanced so as to maximize the utilization of the transmission system.
- The terminal voltage of all the equipments in the system should be within the acceptable limits.

The above objectives ensure that the power system network mainly operates for active power. An increase in the load demand or decrease in generation or transmission facilities causes voltage drop, which further reduces the reactive power from the capacitor and line charging, which further reduces the voltage causing a voltage collapse of the power system network. Thus by controlling the reactive power the voltage profile of the system can be maintained within the acceptable limits which can reduce the transmission losses.

This can be done by the installation of Flexible AC Transmission System (FACTS) devices in the weakest regions of the system which reduces the power flow in heavily loaded lines, improving the stability of the system with reduced production cost [2]. A review of the literature imparts that there is a continuous investigation for developing various voltage stability indices by the power system researchers to investigate the various aspects of static load flow analysis and to assess the proximity to voltage collapse of a power system network and voltage security of a system [3-7].

Because of their pattern classification and object recognition capability Artificial Neural Network (ANN) has been successfully applied in many power engineering problems. Because of the ability of ANN to

handle non-linear dependencies ANN has attained increasing importance in the system securities assessment. ANN can be applied to problems, for which analytical methods do not yet exist and the networks are easy to maintain.

The objective of the present work is to develop a hybrid technique comprising of Artificial Neural Network (ANN) by a supervised learning algorithm and voltage stability indexes for the prediction of voltage security state of a power network. For this purpose a new and efficient voltage stability index termed as the Transference Index (TI) has been developed. The effectiveness of the proposed index has been compared with a standard voltage stability indicator known as Fast Voltage Stability Index (FVSI) [8]. The paper is catalogued as follows:

The first stage comprises of the formulation of the proposed Transference Index (TI) and it is used for the voltage stability assessment of a standard IEEE 30-bus system considering contingencies. Ordinarily, in Modern Energy Management Systems (EMS) the well known function is the Contingency Analysis which gives information about the static security of the system to the power system operator [9-10]. Further FACTS devices have been incorporated in the critical bus and its effect on the overall system stability has also been shown in the study. The second stage includes the application of Artificial Neural Network (ANN) to the system for prediction of voltage stability state of the system for any unknown loading patterns of the system [10-16]. In the present work multilayer Feed Forward Neural Network (FFNN) has been used i.e. we have used a supervised learning algorithm to estimate the TI for various loading configurations of the system. The network was trained using error back propagation learning algorithm i.e. training of the input data set for exploitation by the ANN pattern recognition engine to predict the voltage stability margin [11-15].

## 2. INDICES FORMULATION

### 2.1. Fabrication of the Proposed Problem

In the proposed equivalent  $\pi$  model of 2-bus network the generated power of slack bus is denoted as  $S_g = P_g + jQ_g$  and that of load bus is  $S_L = P_L + jQ_L$ . The slack bus voltage is  $V_g$  and the power transmission receiving end voltage is  $V_L$ . The equivalent impedance of the line is  $Z_{eq}$  and the power angle in radian is  $\delta$ . The shunt branch current at the sending end and at the receiving end are  $I_{ss}$  and  $I_{sr}$  respectively.

From Figure 1, at node n :

$$I = I_{sr} + I_2$$

$$I_2 = I - I_{sr} = \frac{(V_g - V_L)}{Z_{eq}} - V_L \cdot Y_{sr}$$

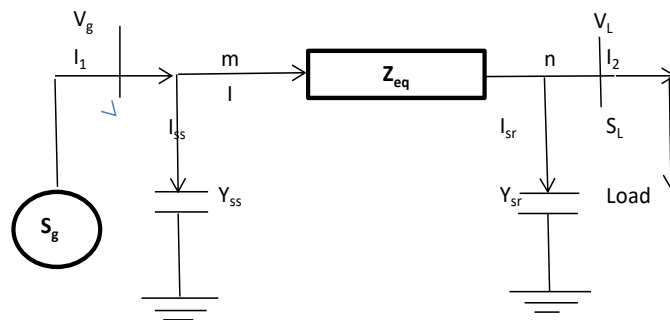

Figure 1. Equivalent  $\pi$  model of 2-bus network for the proposed methodology

$$\begin{aligned} \text{Again, } I_2 &= \frac{S_L}{V_L} \\ \therefore \frac{S_L}{V_L} &= \frac{(V_g - V_L)}{Z_{eq}} - V_L \cdot Y_{sr} \\ \Rightarrow S_L &= \frac{1}{Z_{eq}} \cdot V_L \cdot (V_g - V_L) - V_L^2 \cdot Y_{sr} \\ &\Rightarrow -V_L^2 \cdot Y_{sr} + \frac{1}{Z_{eq}} \cdot V_L \cdot (V_g - V_L) - S_L = 0 \end{aligned} \quad (1)$$

Arranging Equation (1) gives the quadratic equation for the receiving end bus which is given by,

$$-V_L^2 \cdot \left( Y_{sr} + \frac{1}{Z_{eq}} \right) + \frac{1}{Z_{eq}} \cdot V_g \cdot V_L - S_L = 0 \tag{2}$$

In order to maintain real roots of VL, the discriminant of Equation (2) must be greater than or equal to zero. Equation (2) is in the form of  $ax^2+bx+c=0$ , hence  $b^2-4ac \geq 0$ . After rearranging the equation is given as:

$$\frac{V_g^2}{Z_{eq}^2} - 4S_L \cdot \frac{(Y_{sr} \cdot Z_{eq} + 1)}{Z_{eq}} \geq 0 \tag{3}$$

$$V_g^2 \geq 4S_L \cdot (Y_{sr} \cdot Z_{eq} + 1) Z_{eq} \tag{4}$$

$$TI = \frac{4S_L \cdot (Y_{sr} \cdot Z_{eq} + 1) Z_{eq}}{V_g^2} \leq 1 \tag{5}$$

Taking j as the receiving end bus and i as the sending end bus the Transference Index for any transmission line is given by,

$$TI_{ij} = \frac{4S_j \cdot (Y_{sr(ij)} \cdot Z_{ij} + 1) Z_{ij}}{V_i^2} \leq 1 \tag{6}$$

where  $Y_{sr(ij)} = j \frac{(-X_{ij})}{\frac{R_{ij}^2 + X_{ij}^2}{2}}$  and R, X, Z are the resistance, reactance and impedance of the transmission line respectively. Ysr is the equivalent line charging susceptance.

Accordingly Equation (6) exhibits that if the Transference Index  $TI_{ij}$  for any transmission line is close to 1.0 then that particular line will be approaching towards instability point which may lead to system violation. Hence, in order to retain the stability of the system, TI should be maintained less than unity.

**2.2. Fast Voltage Stability Index (FVSI)**

The line stability index FVSI was first introduced by Dr. Ismail Musirin (et al) in 2002 which is based on two-bus equivalent network [8]. The calculation is done from the concept of power flow through a transmission line and is formulated as given below

$$FVSI_{ij} = \frac{4Z^2 Q_j}{V_i^2 \cdot X} \leq 1 \tag{7}$$

where Z and X are the impedance and reactance of the line respectively.  $V_i$  is the sending end voltage and  $Q_j$  is the receiving end reactive power flow.

**2.3. Modeling of SVC**

A Static VAR Compensator is a set of electrical device for providing fast acting reactive power on high voltage electricity transmission networks. SVC's are part of the Flexible AC Transmission system (FACTS) device family which provides fast regulation of voltage and power factor, also provides voltage support during contingency events which would otherwise exhaust the voltage for an eloquent period of time. SVC is also helpful in damping of power swings and reduction in transmission losses by reactive power control. The modelling of SVC is done with the help of reactors and capacitors which are controlled by thyristor valves in parallel with a fixed capacitor bank. In a transmission line it is connected in parallel through a shunt transformer. The first use of static var compensators in EHV/UHV transmission started in 1960s and was based on saturated reactors. The first switched compensators were installed in late 1970s. Since that time the use of SVC has become very popular to replace synchronous compensation (using synchronous phase modifiers).

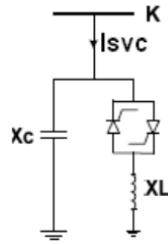

Figure 2(a). SVC firing angle model

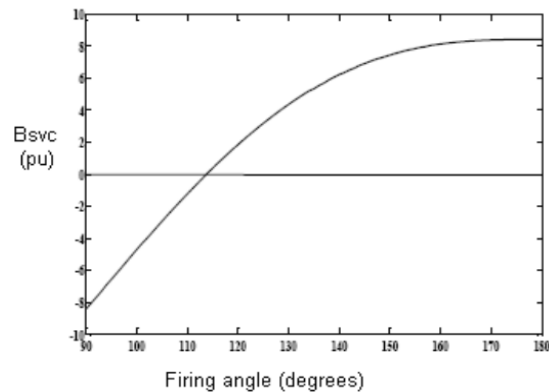

Figure 2(b). SVC equivalent susceptance profile

Figure 2(a) represents the SVC firing angle model and Figure 2(b) represents the equivalent susceptance profile of the SVC [15]. In practice the SVC can be seen as an adjustable reactance with either firing angle limits or reactance limits. The equivalent circuit of the SVC is used to derive the SVC non-linear power equations and the linearized equations required by Newton's Method.

The magnitude of the SVC susceptance  $B_{SVC}$  [14] is a function of the firing angle  $\alpha$  and is obtained as:

$$B_{SVC} = \frac{2\pi - 2\alpha + \sin 2\alpha}{\pi X_s} \quad \text{for } 0^\circ \leq \alpha \leq 90^\circ$$

Accordingly  $B_{SVC}$  is controllable using SVC at any node of the power network. The current drawn by the SVC is given by:

$$I_{SVC} = jB_{SVC} \cdot V_k$$

Assuming the SVC being connected at the  $k$ th bus. The reactive power drawn by the SVC injected at bus  $k$  is obtained as:

$$Q_{SVC} = -V_k^2 \cdot B_{SVC}$$

where  $V_k$  is the  $k$ th bus voltage. The changing susceptance represents the total SVC susceptance necessary to maintain the nodal voltage magnitude at the specified bus. Once the level of compensation is computed, then the thyristor firing angle can be calculated. However, the additional calculation requires an iterative solution because the SVC susceptance and the thyristor firing angle are non-linearly related. The reactive power is a function of the square of the bus voltage. Hence, with the decrease in the voltage the generated reactive power also decreases.

The SVC impedance is initialized at the resonance point i.e.  $X_{TCR} = X_C$  when  $Q_{SVC} = 0$  which corresponds to a firing angle of  $108^\circ$  and the parameters adopted are  $X_L = 0.0129$  p. u and  $X_C = 0.0406$  p. u. Thus the maximum reactive power which the SVC can inject is  $0.246$  p. u. i.e.  $24.6$  MVar.

### 3. RESULT AND DISCUSSION

The proposed Voltage stability Indices has been tested on a standard IEEE 30-bus system. The static power flow analysis is done by Newton Raphson method in Matlab software to identify the weakest, weaker and the weak bus of the system using  $\frac{dQ_i}{dV_i}$  (reactive power sensitivity) indicator which is shown in Table 1.

Table 1. Stability ranking of buses

Bus No.	dQi/dVi value	Ranking
13	1.7207	Weakest
2	2.8623	Weaker
5	3.4766	Weak

Table 1 indicates that bus no. 13 is the critical bus of the system with the smallest value of  $\frac{dQ_i}{dV_i}$  and the next smaller value is of bus no.2 which is the weaker bus and bus no.5 is the weak bus of the system. Since low value of dQ/dV means dV/dQ will be high, indicating large change in voltage for variation of the reactive power of the bus.

#### 3.1. Interpretation of TI and FVSI on IEEE 30-bus system

The proposed Transference Index (TI) is now coordinated to the various transmission lines of the IEEE 30-bus system and its performance is compared with the standard Fast Voltage Stability Index (FVSI). From Equation (6) and equation (7) it is clear that the transmission lines having values of TI and FVSI close to unity will be more recumbent to instability than those having lesser values. Thus based on the maximum values of TI, the ranking of different transmission lines has been made under heavy loading of the critical bus i.e. bus no. 13 and concealing the other buses fixed at their respective base loads. The effect in the value of TI with the embodiment of SVC in the critical bus has also been depicted. The ranking of different transmission lines are then compared with the standard FVSI values under heavy loading condition of the critical bus. The values of TI with and without the placement of SVC in the critical bus for various transmission lines has also been compared with the values of FVSI . The comparison has been depicted in Table 2 and Table 3.

Table 2 demonstrates the values of TI and FVSI for a particular transmission line when the critical bus is heavily loaded without any inclusion of SVC. It depicts that the values of both the indexes (TI and FVSI) are higher for the transmission line 38 which shows that line 38 is more vulnerable to voltage collapse in the system. When the proposed TI is compared with the standard FVSI it shows that the ranking of the transmission lines are similar with both the indexes which justifies the feasibility of the proposed TI.

Table 2. Ranking of Transmission lines without SVC for heavily loaded critical bus 13

Loading at critical bus 13	Line	From	To	TI	FVSI	Rank
P = 0.35	38	11	2	0.3748	0.0685	1
Q = 0.023	39	5	2	0.2957	0.0540	2
	20	14	15	0.1120	0.0461	3
	27	10	21	0.0784	0.0424	4
	37	11	5	0.0614	0.0234	5
	26	10	17	0.0445	0.0223	6
	19	12	16	0.0381	0.0175	7
	4	3	4	0.0134	0.0028	8

Table 3 demonstrates the effect on the values of TI and FVSI by placing an SVC at the critical bus. It is observed that for the same loading on the critical bus the stability of the system with both the proposed TI and FVSI has improved as there is a decrease in the values of TI and FVSI for the respective transmission lines. Again the expediency of the proposed Transference Index (TI) has been established.

Table 3. Ranking of Transmission lines with SVC for heavily loaded critical bus 13

Loading at critical bus 13	Line	From	To	TI	FVSI	Rank
P = 0.35	38	11	2	0.3533	0.0646	1
Q = 0.023	39	5	2	0.2528	0.0462	2
with SVC	20	14	15	0.1100	0.0451	3
	27	10	21	0.0746	0.0403	4
	37	11	5	0.0579	0.0222	5
	26	10	17	0.0424	0.0210	6
	19	12	16	0.0366	0.0168	7
	4	3	4	0.0133	0.0028	8

A study has been made on how the index values change with the change in load. This is done by changing the active load on the critical bus no. 13, keeping the load on other buses fixed at their respective base loads. Initially the test is started from the base value of P or active load and is gradually increased in steps of 5% of the base value for line 39 until the system fails to converge and the values of TI and FVSI are computed. Line no. 39 has been chosen as it comprises of both the weaker and the weak bus. The steps are being repeated by connecting an SVC in the critical bus 13.

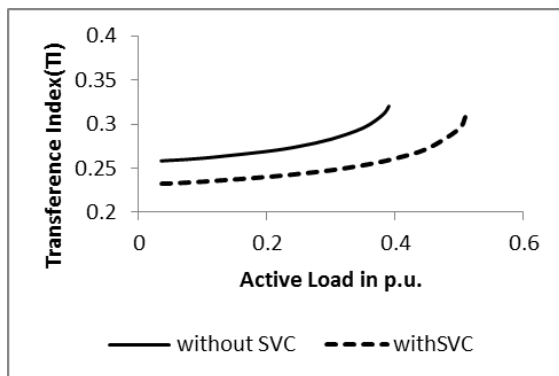

Figure 3. Plot of TI against active power loading for line 39

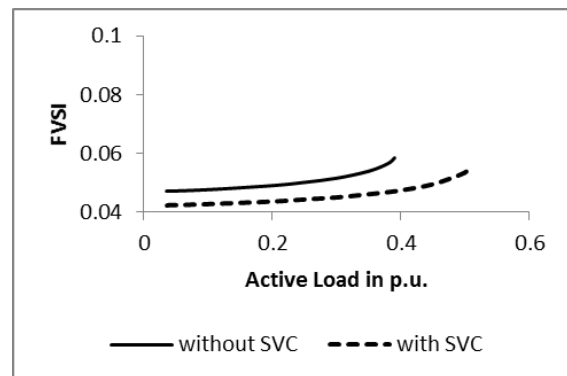

Figure 4. Plot of FVSI against active power loading for line 39

Figure 3 and Figure 4 respectively divulges the plotting of proposed TI and FVSI with and without the incorporation of SVC at bus 13 against active or P loading in bus 13 for transmission line 39. If a comparison is being made between Figure 3 and Figure 4 it can be manifested that the value of FVSI is reduced by a small amount with the application of SVC whereas the value of the proposed TI is greatly reduced with the application of SVC. Thus it can be concluded that the stability margin of the system can be easily diagnosed from the values of the proposed TI. Since in the proposed methodology the effect of line charging susceptance has been considered through  $\pi$  model of the equivalent circuit, the efficiency and stability of the system increases by reducing the power losses. Also the power factor of the system improves which reduces the KVA drawn from the supply. Henceforth, the proposed Transference Index (TI) has been proved to be more advantageous with respect to FVSI.

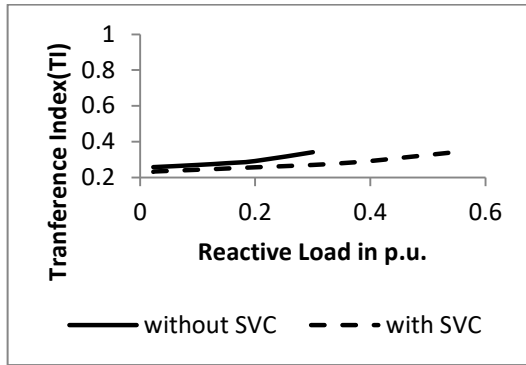

Figure 5. Plot of TI against reactive power loading for line 39

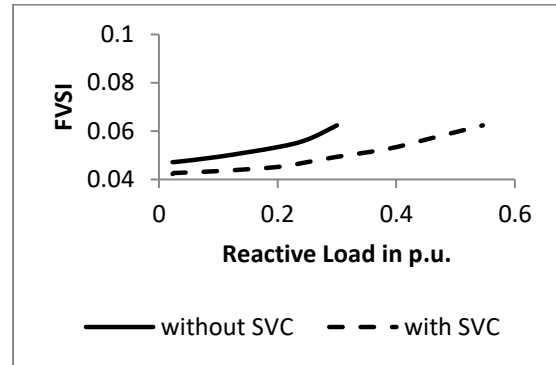

Figure 4. Plot of FVSI against reactive power loading for line 39

Similarly, the proposed TI values can be computed by increasing the Q or reactive power loading of bus 13 keeping the P load fixed at the base value till the system collapses. Figure 5 and Figure 6 respectively shows the variation of the proposed TI and FVSI against Q loading of critical bus 13 with and without the application of SVC at bus 13.

Table 4. Changes in the critical values for IEEE 30-Bus system due to SVC

Critical Parameters	Without SVC	With SVC
P <sub>cri</sub>	0.39	0.51
Q <sub>cri</sub>	0.3	0.546

Table 4 shows that the P loading and Q loading of the system has increased due to placement of SVC at the critical bus 13. The active power loading has been increased by 0.12 p.u. and the reactive power loading has been increased by 0.246 p.u.

#### 4. ANN ARCHITECTURE

The Neural Network based technique has become a most imaginably assertable, a very appealing and an accrual beneficial trend in the recent development of the power system. In this network the information moves unidirectionally in the forward direction starting from the input nodes through the hidden nodes and finally to the output nodes [16-17]. Figure 7 shows the architecture of Feed Forward Neural Network (FFNN).

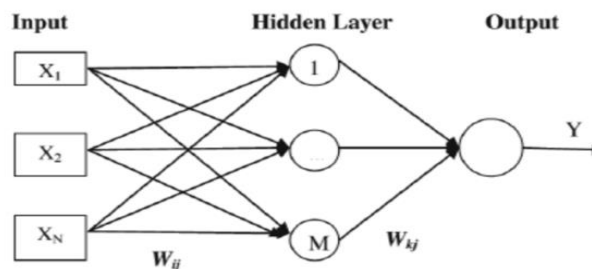

Figure 7. Architecture of ANN

##### 4.1. Learning Algorithm

The FFNN uses a supervised learning algorithm. The learning comprises of a pattern presented at the inputs which gets transformed in its passage through the layers of the network till it reaches the output layer. The outputs of the network are then compared with the outputs as they ideally would have been if this pattern were classified correctly. In this paper multilayer FFNN learning algorithm has been used which uses

the technique of back propagation. Often we use the term back propagation because the differences between the actual and the idealized outputs are back propagated from the top to the lower layers to compute some predefined error function. After performing many epochs and at the termination of the learning phase, the neural network will be able to generalize and classify correctly any unknown pattern conferred to it and the network has learned a certain target function.

#### 4.2. ANN Training and Exploitation

The network was trained with “error back propagation” supervised learning algorithm. The trained network is exploited to predict the Transference Index indicator value. “Tansig” and “purelin” transfer functions were used during training of network. The process of finding a set of weights such that for a given input the network produces the desired output is called training. In this study the training of the input data set is done on different configurations of the system based on the base configuration of the system and heavy loading on the weaker sections of the system. It also includes single and double outages of transmission lines, generator outages, placement of SVC in the critical bus and the corresponding TI and FVSI values were calculated under all the probable loading and system patterns. This has come up with the generation of 15 different system topologies, 20 different combinations of bus loading and altogether 2100 samples of data. Each data having its own topology code, active and reactive power loading and the correspondent TI value.

After the termination of training learning algorithm of the data set, the ANN architecture is finally optimized for 7 input layer neurons i.e. voltage, active and reactive power loading for the weak, weaker and weakest buses, 4 hidden layer neurons and 1 output layer neurons using the target TI data. The classification capability of the proposed ANN is checked into thoroughly by using 350 epochs. The execution of the ANN was tested on IEEE 30-bus system for 10 unknown loading patterns by computing the error for every testing pattern. The error is fabricated by correlating the actual values of TI with the ANN generated values of TI and the enumerated test results are given in Table 5.

Table 5. Accuracy of the proposed ANN Pattern Engine

System Configuration	Actual TI value	ANN generated TI value	% Error
Configuration 1 with line 35 outage	0.2532	0.2528	-0.15
Configuration 2 with line 25 outage	0.2589	0.2594	0.19
Configuration 3 with Gen 1 outage	0.2549	0.255	0.04
Configuration 4 with Gen 2 outage	0.2560	0.2566	0.23
Configuration 5 with line 11 & 22 outage	0.2573	0.2573	0
Configuration 6 with SVC in critical bus	0.2319	0.2314	-0.22
Configuration 7 with SVC in the critical bus and line 14 outage	0.2365	0.2365	0
Configuration 8 with SVC in the critical bus and line 23 outage	0.2318	0.232	0.09
Configuration 9 with heavy load in the critical bus and line 23 outage	0.2956	0.2953	-0.10
Configuration 10 with heavy load in the critical bus and Gen 2 outage	0.3081	0.3076	-0.16

From Table 5 it is observed that the most contingent configured is No. 10, i.e. the configuration 10 with heavy load on the critical bus when Generator 2 is tripped because in this condition the value of TI is maximized. While the minimum value of TI is at Configuration 8 with SVC in the critical bus and line 23 outage, which is least contingent configuration. Table 5 also demonstrates the accuracy and reliability of this ANN based pattern recognition engine. From Table 5 it is experienced that the error in estimation lies between +0.23 to -0.64, which is brilliant and sufficient for this purpose.



## 5. CONCLUSION

A methodology for monitoring and predicting of voltage stability state of a multi bus power system network has been conferred in this paper using ANN based pattern classification engine. The proposed Transference Index (TI) has been formulated from a two bus equivalent network and tested on IEEE-30 bus system. Simulation results also show that embodiment of a compensating device at the critical bus dynamizes the overall system stability. Further ANN has been exploited to anticipate the voltage security state of the system with the aid of the proposed index. The proposed technique has been tested on IEEE 30-bus system and its workability are shown in both learning and training stages of ANN. The procedure depicted in this paper has shown a high degree of factualness between the targeted and the ANN output. After training only a few seconds are required to predict the output during the verification stage. The proposed approach has thus proved to be efficient, precise and fast for the computation of the TI i.e. the stability state of the system for any unknown loading patterns and contingencies which will help the power system operator to adopt any necessary action if required in Smart Grid Scenario.

## REFERENCES

- [1] I. O. Akwukwaegbu and O. Gerald Ibe, "Concepts of Reactive Power Control and Voltage Stability Methods in Power System Network", *IOSR Journal of Computer Engineering*, vol. 11, Issue 2(May-June.2013), pp.15-25
- [2] G. Saha, K. Chakraborty and P. Das, "Detection of Proximity to Voltage Collapse of Multi-Bus Power Network using Transmission Line Voltage Stability Indicator.", *ARPN Journal of Engineering and Applied Sciences*, vol. 11, no. 17, September 2016, pp. 10689-10694.
- [3] S. Singh, J. Hammant and A. Kashiv, "Application of SVC on IEEE 6 Bus System for Optimization of Voltage Stability", *TELKOMNIKA (Indonesian Journal of Electrical Engineering and Computer Science)*, vol.3, No.1, pp. 1-6, March 2015
- [4] P. Pourbeik, P. Kundur and C. W. Taylor, "The anatomy of a power grid blackout – Root causes and dynamics of recent major blackouts," *IEEE Power and Energy Magazine*, pp.22-29, Sept.-Oct.2006
- [5] P. Pavithren, R. R. Raman, P. Nair and K. Nithiyanthan, "Voltage Stability Analysis and Stability Improvement of Power System", *TELKOMNIKA (Indonesian Journal of Electrical Engineering and Computer Science)*, vol.5, No.2, pp. 189-197, April 2015
- [6] P. A. Lof, G. Anderson and D. J. Hill, "Voltage Stability Indices for stressed power systems", *IEEE Trans. Power System.*, vol.8 No.1, pp.326-335, 1993
- [7] A. F. Mohamad Nor, M. S. A. F. A. Kadir and R. Omar, "Voltage Instability Analysis for Electrical Power System Using Voltage Stability Margin and Modal Analysis", *TELKOMNIKA (Indonesian Journal of Electrical Engineering and Computer Science)*, vol.3, No.3, pp. 655-662, September 2016
- [8] I. Musirin and T. K. A. Rahman, "Novel Fast Voltage Stability Index (FVSI) for voltage stability analysis in Power Transmission System", 2002 Student Conference on Research and Development Proceedings, Shah Alam, Malaysia, July 2002
- [9] T. Mandloi and A. K. Jain, "A Study of Power System Security and Contingency Analysis", *IJSRET*, vol.3, Issue4, July 2014
- [10] A. Naaz, L. Sayyed, P. M. Gadge and R. U. Sheikh, "Contingency Analysis and Improvement of Power System Security by locating FACTS Devices "TCSC and TCPAR" at Optimal Location", *IOSR Journal of Electrical and Electronics Engineering*, p- ISSN : 2320-3331, pp.19-27, 2014
- [11] K. Chakraborty and G. Saha, "Off-Line Voltage Security Assessment of Power Transmission Systems using UVSI through Artificial Neural Network.", 2016 ICICPI IEEE, vol. 978-1-5090-2638-8/16, pp. 159-163.
- [12] K. Chakraborty, A. Chakrabarti and A. De, "A combined ANN-IVSI approach for assessment of voltage stability in a power system." *IJMRAE*, vol.3, No. I (January 2011), pp.197-212
- [13] S. Kanalaasadan, A. K. Srivastava and D. Tukaram, "Novel Algorithm for Online Voltage Stability Assessment based on Feed Forward Neural Network", *IEEE Trans. On Power Engineering Society General Meeting*, pp.1-7, 2006.
- [14] K. Chakraborty, A. De and A. Chakrabarti, "Assessment of voltage security in a multi bus power system using Artificial Neural Network and voltage stability indicators." *Journal of Electrical Systems*, 6-4(2010):517-529
- [15] O. P. Rahi, A. Kr Yadav, H. Malik, A. Azeem and B. Kr, "Power system voltage stability Assessment through Artificial Neural Network." *ELSEVIER Procedia Engineering*, vol. 30(2012), pp. 53-60
- [16] K. Chakraborty, A. De and A. Chakraborty, "Voltage Stability Assessment in Power Network using Self Organizing Feature Map and Radial Basis Function", *Computers and Electrical Engineering*, Elsevier, vol.-38, No. -4, pp. 819-826, July 2012.
- [17] K. Chakraborty, A. Chakraborti, and A. De, "Integrated Voltage stability indicator based Assessment of voltage stability and application of ANN." *Iranian Journal of electrical and Computer Engineering*, vol.10, No.2, Summer-Fall 2011.