

wave run-up and overtopping

**technical advisory committee
on protection against inundation**

Handwritten text, possibly a signature or title, which is extremely faint and illegible.

First published in Holland as "Golfoploop en Golfoverslag".

The Hague, 1972.

WAVE RUN-UP AND OVERTOPPING

CONTENTS

	Page
PREFACE	
GENERAL INTRODUCTION	7
PART I SUMMARY AND CONCLUSIONS	
I.1 INTRODUCTION	7
I.2 EXCERPT OF PARTS II, III and IV	9
I.2.1 Description of irregular waves	9
I.2.2 Wave run-up	11
I.2.3 Wave overtopping	18
I.3 RECOMMENDATIONS FOR FURTHER STUDY	19
I.4 NOTES ON RUN-UP AND OVERTOPPING AS DESIGN CRITERIA	21
PART II RUN-UP OF REGULAR WAVES	
II.1 INTRODUCTION	22
II.2 PARAMETERS	23
II.3 THEORIES	25
II.3.1 Introduction	25
II.3.2 Breaking criteria	25
II.3.3 Theories for run-up of non-breaking waves	29
II.3.4 Theories for run-up of breaking waves	36
II.4 QUALITATIVE EXPERIMENTAL RESULTS	40
II.4.1 Introduction	40
II.4.2 Slope angle α	41
II.4.3 Angle of incidence β	41
II.4.4 Wave steepness H/gT^2	41
II.4.5 H/d ratio	42
II.4.6 Reynolds number Re	42
II.4.7 Weber number We	42

	page	
II.5	QUANTITATIVE EXPERIMENTAL RESULTS	44
II.5.1	Introduction	44
II.5.2	Smooth, plane slope	44
II.5.3	Plane slope with roughness elements	55
II.5.4	Rough and permeable slope	65
II.5.5	Non-plane, smooth slope	69
II.5.6	Oblique incidence	81
II.6	REFERENCES	84
PART III	RUN-UP OF IRREGULAR WAVES	
III.1	INTRODUCTION	94
III.2	PARAMETERS	95
III.3	THEORIES	98
III.3.1	Introduction	98
III.3.2	Run-up distributions	99
III.4	QUALITATIVE EXPERIMENTAL RESULTS	105
III.4.1	Introduction	105
III.4.2	Slope angle α	105
III.4.3	Angle of incidence $\bar{\beta}$	105
III.4.4	Wave steepness H_k/gT_k^2	106
III.4.5	Ratio H_k/d	106
III.4.6	Reynolds number Re_k	106
III.4.7	Weber number We_k	106
III.4.8	Form of energy spectrum	106
III.4.9	Wind speed parameter \bar{w}_{10}^2/gH_k	106
III.4.10	Wind direction $\bar{\varphi}_w$	107
III.5	QUANTITATIVE EXPERIMENTAL RESULTS	108
III.5.1	Introduction	108
III.5.2	Field measurements	110
III.5.3	Plane, smooth slope	115
III.5.4	Plane slope with roughness elements	129
III.5.5	Rough and permeable slope	133
III.5.6	Non-plane, smooth slope	133
III.5.7	Oblique incidence	137
III.5.8	Wind influence	141
III.6	REFERENCES	145

	page	
PART IV	WAVE OVERTOPPING	
IV.1	INTRODUCTION	148
IV.2	PARAMETERS	149
IV.3	THEORIES	150
IV.4	QUALITATIVE EXPERIMENTAL RESULTS	154
	IV.4.1 Introduction	154
	IV.4.2 Slope angle α	154
	IV.4.3 Relative crest height h_d/H_k	154
	IV.4.4 Angle of incidence $\bar{\beta}$	154
	IV.4.5 Wave steepness H_k/gT_k^2	154
	IV.4.6 Ratio H_k/d	155
	IV.4.7 Reynolds number Re_k	155
	IV.4.8 Weber number We_k	155
	IV.4.9 Form of energy spectrum	155
	IV.4.10 Wind velocity parameter \bar{w}_{10}^{-2}/gH_k	155
	IV.4.11 Wind direction $\bar{\phi}_w$	155
IV.5	QUANTITATIVE EXPERIMENTAL RESULTS	156
	IV.5.1 Introduction	156
	IV.5.2 Field measurements	156
	IV.5.3 Vertical seawall	156
	IV.5.4 Plane, smooth slope	160
	IV.5.5 Plane slope with roughness elements	166
	IV.5.6 Rough and permeable slope	168
	IV.5.7 Non-plane, smooth slope	168
	IV.5.8 Oblique incidence	169
	IV.5.9 Wind influence	169
IV.6	REFERENCES	170
	LIST OF SYMBOLS	172

PREFACE

One task of the Working Group on "Wave Problems at Dikes" set up by the Technical Advisory Committee on protection against inundation is to study problems connected with wave run-up and wave overtopping at dikes and similar structures.

Within these terms of reference, the Working Group began by cataloguing existing knowledge through an extensive search of the available literature. It made a critical analysis of this literature from which guidelines have emerged for further study. A full report is contained in the publication entitled "Wave run-up and wave overtopping" which was drafted by Mr. J.A. Battjes of the Delft Technological University. The final text was edited by Mr. Battjes and Mr. W.A. Venis of the Rijkswaterstaat Deltadienst.

The Technical Advisory Committee on protection against inundation believes that this report will be of interest to everyone concerned with the design or maintenance of dikes and recommends it to all engineers who have to consider wave run-up and wave overtopping on dikes.

The Hague,
January 1972

J.B. Schijf
Chairman,
Technical Advisory Committee on
protection against inundation.

GENERAL INTRODUCTION

In compiling the report entitled "Wave run-up and overtopping", topping", an attempt was made to:

- summarize existing literature,
- analyse and interpret the data quoted in this literature,
- where possible, correlate the results from the different literature sources,
- give recommendations for further study, and
- consider the application of the results.

This report only deals with the fluid-mechanical aspects of wave run-up and wave overtopping. The characteristics of the waves and the shore structure are taken as known. It is further assumed that the structure is rigid.

A selection has been made in presenting the data; results of an incidental nature are not generally reproduced. In addition in, a number of instances relatively detailed attention is given to data which may be of particular interest to conditions in the Netherlands.

Although data on the run-up and overtopping of regular waves are not directly applicable to irregular waves, they have still been included; in this way a contribution can be made to the qualitative, and in some cases also quantitative knowledge of the phenomena, provided that the stochastic nature of irregular waves is taken into account.

The report consists of four parts. Part I contains an excerpt of the literature summary given in Parts II, III and IV. It also contains recommendations for further study and some notes on the use of data in respect of run-up and overtopping in the design of dikes. Parts II and III deal with the run-up of regular and irregular waves respectively. It was felt desirable to deal with run-up in two separate parts because of the large quantity of data available on this subject. Finally, Part IV summarizes the literature on wave overtopping.

Parts II, III and IV follow the same pattern. A bibliography is attached to each of these parts. The symbols used are shown in a list at the end of the report.

PART I

SUMMARY AND CONCLUSIONS

I.1 INTRODUCTION

This part of the report entitled "Wave run-up and overtopping" consists largely of an excerpt from the survey of existing literature contained in the following parts. This survey covers regular and irregular breaking and non-breaking waves.

Chapter I.2 briefly summarizes certain experimental data on run-up and overtopping of irregular breaking waves. In a number of instances these data are supplemented by information relating to regular waves, i.e. whenever it appears that the influence of specific parameters may be the same for both categories. This holds good in particular for the influence of roughness and permeability. Chapter I.2 begins with a short description of the characteristics of irregular waves. References to Parts II, III and IV are shown as follows [.....] . References to literature are not repeated.

Chapter I.3 makes a number of recommendations for further study while Chapter I.4 describes briefly the application of wave run-up and wave overtopping as design criteria for dikes.

I.2 EXCERPT OF PARTS II, III AND IV

I.2.1 Description of irregular waves [III.2]

Irregular waves can only be described in the statistical sense. We may consider the probability distribution of the individual wave height H (the maximum difference in water level between two successive zero crossings in the downward direction) or that of the individual wave period T (the time elapsing between the same two zero crossings) and also the joint distribution of H and T . These distributions are defined by their shape, a characteristic wave height H_k and a characteristic wave period T_k . The mean wave period \bar{T} is generally taken for T_k . The mean of the highest third of the wave heights $H_{\frac{1}{3}}$ or the mean of all wave heights \bar{H} are usually taken for H_k . The value which is exceeded by 50% of the wave heights $H_{(50)}$ and the root-mean-square wave height $H_m = \sqrt{H^2}$ are also used.

The height distribution of wind-generated waves corresponds approximately to the Rayleigh distribution given by

$$\text{Prob. [wave height} \geq H, \text{ for given } \bar{H}] = e^{-\frac{\pi}{4} \left(\frac{H}{\bar{H}}\right)^2} \quad (\text{I.2.1})$$

The following relations between the above-mentioned wave heights can be derived from this:

$$1.06 H_{(50)} = \bar{H} = 0.89 H_m = 0.63 H_{\frac{1}{3}} \quad (\text{I.2.2})$$

Together with equation I.2.1 these relations are shown in figure I.2.1.

Measurements have shown that the local wave lengths which are primarily determined by the periods and depth in front of the dike have no direct influence on the run-up and overtopping of waves breaking on the slope. However, the periods appear to be important. A fictitious deep water wave length can be calculated from a characteristic period T_k on the basis of the formula for regular waves [equ. II.3.2] :

$$L_{o,k} = \frac{g T_k^2}{2\pi} \quad (\text{I.2.3})$$

For $T_k = \bar{T}$ this is written as

$$\tilde{L}_o = \frac{g \bar{T}^2}{2\pi} \quad (\text{I.2.4})$$

Statistically, irregular waves may also be described as the sum of a large number of component waves. This leads to the notion of an energy density spectrum indicating how the wave energy is distributed among the components. The spectrum is defined by its

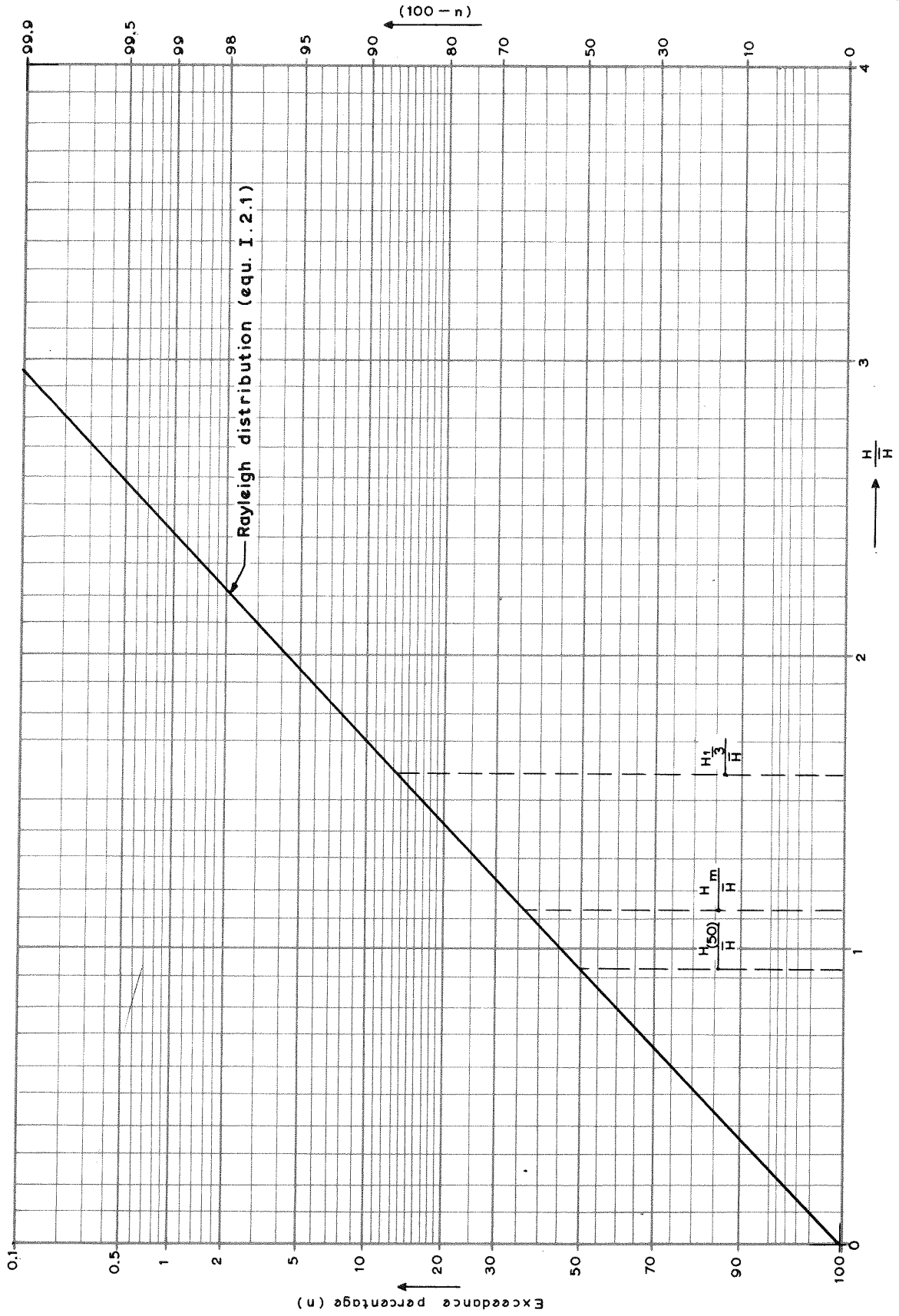

FIG. I.2.1

form, the total wave energy and a characteristic frequency or period. The parameters ϵ , i.e. a measure of the width of the spectrum, and \hat{T} , i.e. the period for which the energy density is maximum are used below.

I.2.2 Wave run-up

Run-up on a plane, smooth slope [III.5.3]

The run-up of waves breaking on a plane, smooth slope with a gradient α is given by

$$z_{(n)} = f_1(n) \sqrt{H_k L_{o,k}} \tan \alpha \quad (\text{I.2.5})$$

or, using equation I.2.3,

$$z_{(n)} = f_2(n) T_k \sqrt{g H_k} \tan \alpha \quad (\text{I.2.6})$$

in which $z_{(n)}$ is the run-up height with exceedance percentage n . The functions $f_1(n)$ and $f_2(n)$ reflect the form of the run-up probability distribution and depend, in addition to the choice of the characteristic parameters, on the statistical structure of the waves concerned, such as the form of the energy density spectrum or the joint distribution of H and T .

If we specify further by taking \hat{T} as the characteristic period, $H_{\frac{1}{3}}$ as the characteristic height and ϵ as the parameter for the form of the energy spectrum, equation I.2.6 becomes [equ. III.5.14]

$$z_{(n)} = C_{(n)}(\epsilon) \hat{T} \sqrt{g H_{\frac{1}{3}}} \tan \alpha \quad (\text{I.2.7})$$

$C_{(n)}$ was measured as a function of ϵ for a number of cases. The results are shown in figure I.2.2 for an exceedance frequency of 2%. This percentage has been chosen for use with current formulae; this choice does not imply that the 2% run-up has any unusual significance other than historical. The figure shows that $C_{(2)}(\epsilon)$ varies from approx. 0.55 with a spectrum which is narrow for wind-driven waves ($\epsilon = 0.34$) to approx. 0.73 with a spectrum which is broad for wind-driven waves ($\epsilon = 0.59$). In calculating ϵ the high-frequency portion of the spectrum has been cut off at the point at which the energy density amounts to 5% of the maximum.

The spread of the probability distribution of the run-up increases with the width of the spectrum. Of the measured distributions the one with the broadest spread corresponds approximately to a Rayleigh distribution, in which case the run-up with an arbitrary

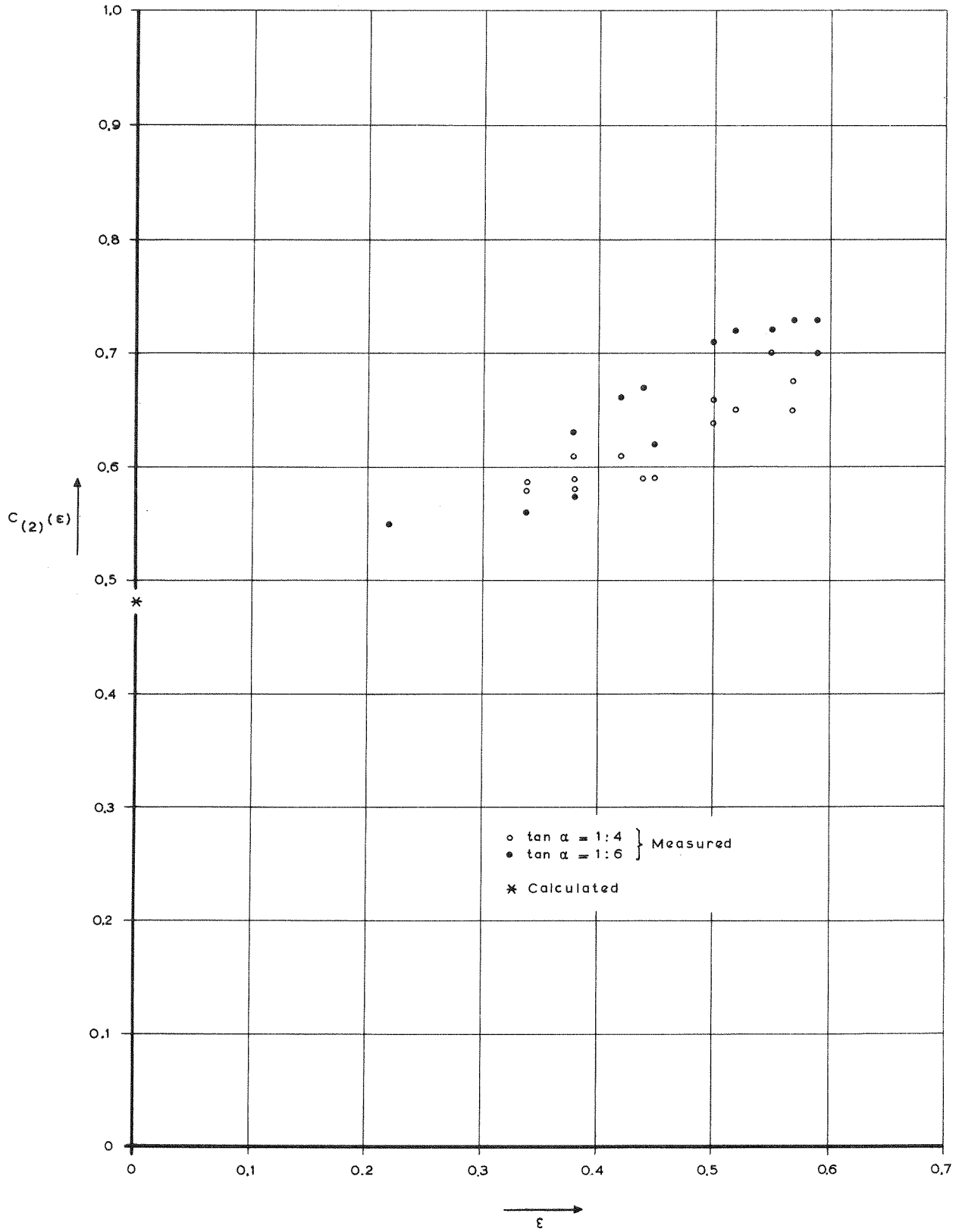

FIG. I. 2. 2

exceedance percentage n can be calculated from $z_{(2)}$ by

$$\frac{z_{(n)}}{z_{(2)}} = 0.77 \sqrt{2^{-10} \log n} \quad (\text{I.2.8})$$

It is assumed above that ϵ is representative of the form of the energy spectrum in so far as it reflects the influence of the latter on the wave run-up distribution. In fact, however, the spectrum may assume many different forms with a given ϵ value. In the tests referred to above, the spectra all had a form corresponding roughly to the standard spectra for sea waves as indicated by Neumann (1953) or by Pierson and Moskowitz (1963). Figure I.2.3.a gives an example. It is not known whether ϵ can also be used for different spectra, two examples of which are shown in figures I.2.3.b and I.2.3.c. In these cases, the parameter \hat{T} used in equation I.2.7 is also less significant.

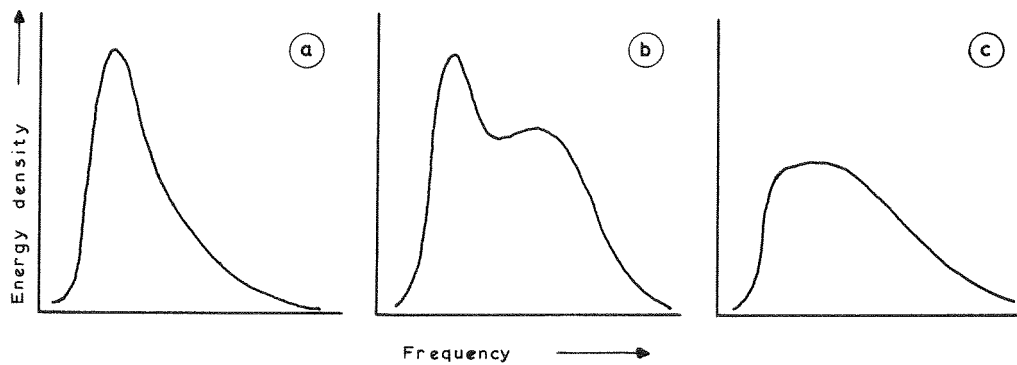

FIG. I.2.3

Measurements in the North Sea have shown that for practical purposes the energy spectrum of the sea waves encountered there may be equated with a Neumann spectrum. If this spectrum is cut off in the manner described above, its breadth ϵ is 0.55. According to figure I.2.2 the corresponding value for $C_{(2)}$ is approx. 0.7 and the 2% run-up is then

$$z_{(2)} \approx 0.7 \hat{T} \sqrt{gH_1^3} \tan \alpha \quad (\text{I.2.9})$$

In the experiments from which the relationship between C and \hat{T} was derived, the ratio \hat{T}/\bar{T} was approx. 1.05. By substituting this ratio together with equation I.2.4 in equation I.2.9, the latter becomes

$$z_{(2)} \approx \frac{1.85}{\sqrt{H_1^3/L_0}} H_1^3 \tan \alpha \quad (\text{I.2.10})$$

For a wave steepness H_1 / \tilde{L}_0 of approx. 5.5%, equation I.2.10 corresponds to the known run-up formula

$$z_{(2)} = 8 H_1 \tan \alpha \quad (\text{I.2.11})$$

[equ. III.5.12] This is not the case for other wave steepness values.

The above observations are based on measurements. Similar results are obtained by assuming that individual waves in an irregular wave train on average cause the same run-up as if they form part of a regular wave train of the same height and period.

Equation I.2.7 relates to breaking waves. In general it is not well known which criteria must be used to determine whether a given irregular wave train should be considered to break fully with a given slope gradient. However, wind-driven waves have steepnesses such that with a slope gradient of 1:3 or less, practically all waves will break. On the other hand, most waves will run up without breaking if the gradient is in the order of 1:1½ or more. There is little experimental information on the run-up of irregular waves which do not break. A theoretically derived formula is given for this purpose in Chapter III.3 but it has not yet been experimentally verified. If all the waves cannot be expected either to break or not to break, an estimate of the run-up may be obtained by ascribing to the individual waves in the irregular wave train a run-up according to figures II.5.1 or II.5.2.

Influence of roughness elements [II.5.3, III.5.4]

Roughness elements on a plane, smooth slope influence the wave run-up. This influence is expressed in factor r , the ratio between the 2% run-up on the rough slope and that on the smooth slope under otherwise identical conditions. The relative reduction in run-up is therefore $(1-r)$.

The value of r is primarily determined by the form and location of the roughness elements and their size in relation to the wave height. The influence of the wave steepness and slope gradient is much less, at least within the intervals of these parameters in the studies concerned which are all related to breaking waves. The reduction in run-up increases slightly as the slope gradient diminishes [figure II.5.8].

It has been found that elements with a square or rectangular cross-section are more effective than elements with a triangular cross-section, e.g. in a stepped slope. For ribs and cubes minimum r values of 0.5 and 0.6 have been measured whereas for stepped slopes of similar size steps the minimum value of r is approx 0.8.

The value of r depends on the distance l between the roughness elements measured in the run-up direction. For ribs with a square cross-section r is lowest when l is equal to approx. 6 times the rib height [figure II.5.7].

The effect of interrupted ribs is slightly greater than that of continuous ribs.

The wave run-up is not noticeably influenced by roughness elements below the mean water level [figure II.5.10]. The reduction in run-up is almost linearly proportional to the width of the rough zone measured in the run-up direction above this level [figure II.5.11].

The influence of the roughness elements increases with the ratio of their height k to the wave height H_k . For regular waves it has been found that the reduction practically ceases to become any greater when $k/H > \text{approx. } 0.1$ [tables II.5.1 and II.5.2]. It is not known at what point this boundary lies for irregular waves.

The above considerations show that a considerable reduction in run-up height can be obtained by incorporating roughness elements. This may lead to a reduction in capital costs. On the other hand, greater damage must be anticipated if the design water level is exceeded [equ. II.5.34]. This is not only the case for roughness elements but also with other factors limiting wave run-up, such as a berm or permeability of the slope covering.

Influence of roughness and permeability [II.5.4, III.5.5]

Certain slope coverings such as rubble have an inherent roughness and permeability. Only the total effect of both factors has been determined in a number of cases. The results are summarized in table I.2.1. The definition of r is similar to that for roughness elements. In the tests in question the stones or blocks were generally just about stable under the influence of the waves.

Covering	r
Smooth, impermeable	1
Concrete blocks	0.9
Set basalt stones } Blocks } Turf }	0.85 to 0.9
Layer of rubble on impermeable base	0.8
Set stones	0.75 to 0.8
Dumped round stone	0.6 to 0.65
Dumped rubble	0.5 to 0.6

TABLE I.2.1

Influence of berm[II.5.5., III.5.6]

To obtain a maximum reduction in wave run-up by means of a berm, the latter must coincide approximately with the mean water level, and have the minimum possible gradient. According to a current formula [equ.III.5.19] the relative reduction in run-up caused by a berm of this kind will be equal to B/L where B is the berm width and L a local wave length in front of the slope which however has not been defined more specifically. There are some indications that the berm width can better be expressed in a fictitious deep water wave length \tilde{L}_0 than in L . It has also been found that the relationship $B/\sqrt{H_k \tilde{L}_0}$ may be important. The variation in the reduction in run-up with berm width is, however, insufficiently known. For irregular waves, the greatest measured reduction is approximately 40% [figure III.5.15].

Influence of oblique wave incidence [II.5.6, III.5.7]

The angle of incidence $\bar{\beta}$ is the acute angle between the wave propagation direction and the horizontal component of the normal on the slope. It appears that the run-up of breaking waves on plane slopes varies according to $\cos \bar{\beta}$ as long as $\bar{\beta} < \text{approx. } 45^\circ$.

In the case of slopes on which a berm influences wave run-up, the latter reduces more sharply than according to $\cos \bar{\beta}$ because the apparent berm width increases in the run-up direction as the waves come in more obliquely. The combined relative reduction is probably not greater than $(1 - 0.6 \cos \bar{\beta})$.

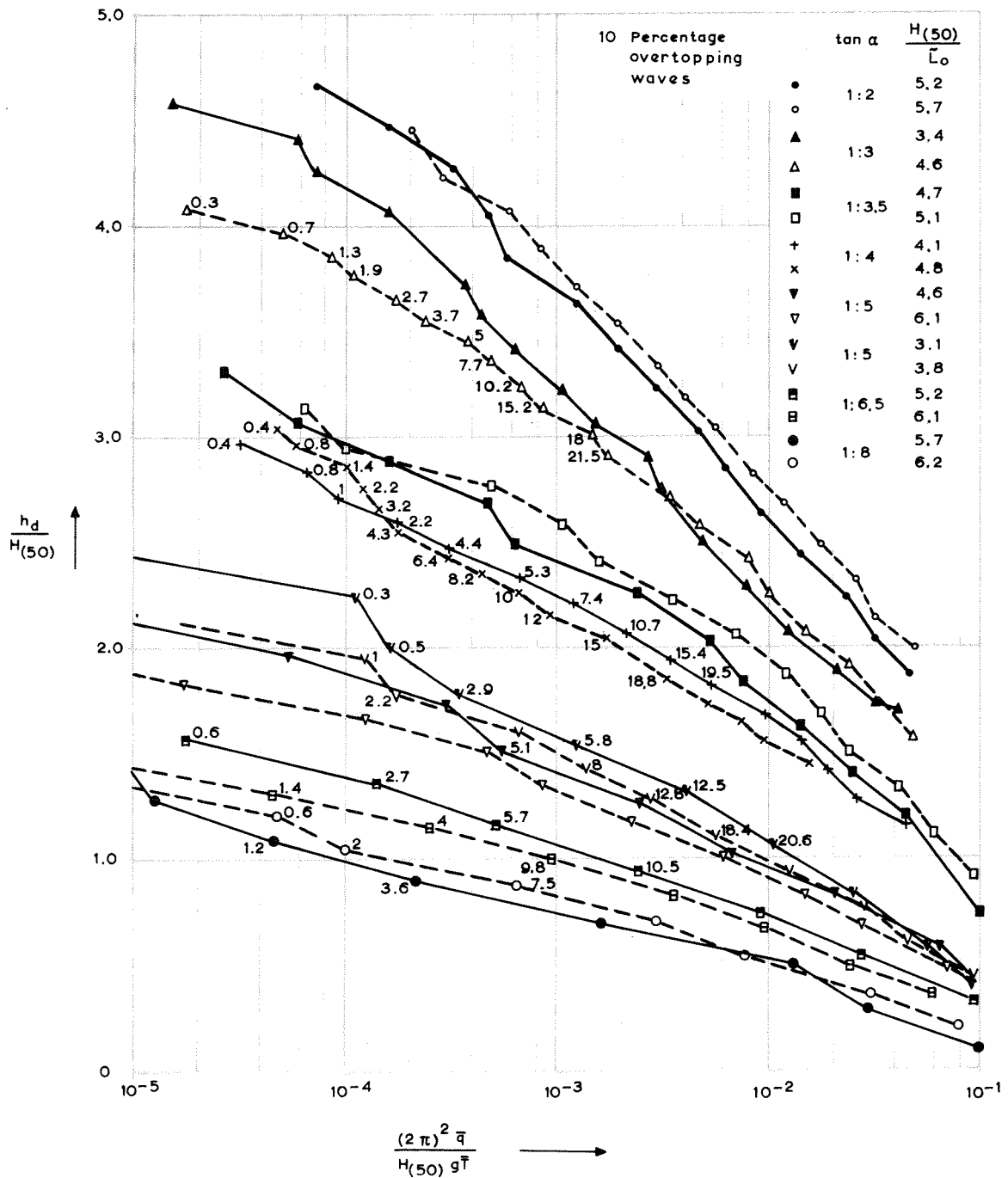

FIG. I.2.4

I.2.3 Wave overtopping [IV]

The amount of data on overtopping of dikes with gentle slopes is small. In respect of the overtopping of irregular waves over dikes with a smooth, plane slope all that is available are the results of a series of tests in which the gradient was varied between 1:8 and 1:2 [IV.5]. The waves were generated entirely by wind which had an exaggerated velocity because of the limited fetch available in the channel. As a result the wave height distributions differed somewhat from those encountered under more natural conditions. The test results are summarized in figure I.2.4 in which the dimensionless overtopping $\bar{q}/gH_{(50)} \bar{T}$ is expressed against $h_d/H_{(50)}$. Here \bar{q} is the time-average of the overtopping discharge per unit of width and h_d the height of the dike crest above the mean water level. The wave steepness $H_{(50)}/\tilde{L}_0$, the slope gradient and the percentage of overtopping waves are also shown in the figure.

I.3 RECOMMENDATIONS FOR FURTHER STUDY

Parts II, III and IV summarize present knowledge of wave run-up and wave overtopping on the basis of available literature. The question is whether and if so to what extent this knowledge must be extended. In answering this question we have assumed that we should be able to make an estimate which is sufficiently reliable for practical purposes, of the run-up and overtopping of irregular waves in a number of instances of a general nature such as a plane, smooth slope, a plane slope with roughness elements, a rough and permeable slope and a slope with a berm. Cases of an incidental nature have not been considered. In these instances an ad hoc solution must always be found.

A comparison of the available knowledge summarized in chapter I.2, with the information which would be desirable, shows that further study is necessary of:

- Run-up and overtopping of irregular waves over dikes with plane slopes.

In most of the tests carried out up to now, the relative wind speed and statistical characteristics of the waves in the model differed slightly from those encountered under natural conditions. In a future study the waves should be more accurately simulated in the model. Steeper slopes (up to approx. $1:1\frac{1}{2}$) should also be included in the study.

- Influence of a berm on wave run-up and wave overtopping.

In view of the fact that dikes with an external berm are very common in the Netherlands, it is important to extend the inadequate information available on this point. The experimental results and the hypothesis described in sections II.5.5 and III.5.6 can provide guidelines for the structure of the study.

- Nature and magnitude of scale effects in run-up and overtopping.

In view of the important function of scale models in the study of run-up and overtopping, it is highly unsatisfactory that practically nothing is known about the scale effects which may occur in this connection. In studying this factor,

attention should be given to various aspects of water movements such as run-up heights, layer thicknesses and velocities.

At a later stage the influence of roughness on overtopping and that of oblique incidence and wind on run-up and overtopping could be studied.

The studies described previously relate to water movements when a given wave impinges on a given stable structure. In so far as run-up and average overtopping volume play a part in the collapse under wave impact, the results of these studies would also be relevant to problems connected with such collapse. However, it seems probable that a more detailed description of the water movement would be necessary. The possibility should be considered of undertaking a study carrying on from the measurements made of a model of the Barrier Dam (Afsluitdijk - M 872). In a study of this kind, factors such as the probability distributions of layer thicknesses, velocities, discharges, pressures and shear stresses should be measured. This could serve as a basis for a study of the entire collapse mechanism and might therefore be of an exploratory nature. The results could be used in preparing a more detailed plan for further research.

I.4 NOTES ON RUN-UP AND OVERTOPPING AS DESIGN CRITERIA

The primary purpose of the report on "Wave run-up and overtopping" is to summarize literature on the subject. In the context of this report, both the incident waves and the structure itself are considered to be known. It is also assumed that the structure is rigid. In designing a dike, however, a design criterion must be chosen for the structure. This problem is essentially outside the scope of this report. In view of present practice however it is desirable to examine in greater detail the use of run-up and overtopping as design criteria. This practice arose because a certain correlation was assumed between the stability of the crest and the inner slope of the dike on the one hand and the quantities of water flowing over the crest on the other. In recent decades, it has frequently been assumed in the design of dikes that under design conditions 2% of the waves may overtop the crest. More recently, the overtopping quantity has also been specifically considered. The criterion that a given percentage of waves may reach the crest does not generally lead to the same result as the criterion that a specific mean quantity of overtopping is permissible. After all, the criterion for wave run-up is relative while that for overtopping is absolute. The higher the waves, the greater will be the quantity of overtopping for an identical percentage of waves reaching the crest.

In quantitative terms, nothing is yet known of the correlation between the stability of the dike and the quantity of overtopping water. In general, the mechanisms involved in the collapse of a dike under wave impact are not well-known. In this situation, the use of a simple criterion such as the 2% run-up has the advantage that it gives a basis for comparison. It is, however, extremely important and urgent to determine better criteria taking into account also the structure of the dike.

PART II

RUN-UP OF REGULAR WAVES

II.1 INTRODUCTION

The run-up of regular waves on slopes has been studied in detail both theoretically and experimentally. The characteristic results are discussed in this part of the report. The following lay-out has been adopted.

Chapter II.2 summarizes the parameters which play a part in the process of wave run-up, using dimensional analysis. A number of theories are discussed in Chapter II.3. Experimental data are presented in the two following chapters: in Chapter II.4 the influences of the various dimensionless parameters referred to in Chapter II.2 are considered in qualitative terms while the quantitative experimental results are dealt with in Chapter II.5. This chapter is structured on the basis of various geometrical factors relating to the slope. The influences of the other dimensionless factors are always considered separately where possible.

II.2 PARAMETERS

The independent parameters which determine the wave run-up on a slope are of three categories, characteristic of:

- a) the structure,
 - b) the water and
 - c) the wave motion.
- a) It is assumed that the slope is completely rigid and stationary. For the consideration of wave run-up (and also overtopping) this assumption seems reasonable so that the dynamic characteristics of the slope are not taken into account. The slope is then determined entirely by its geometry. It is also assumed that this geometry and that of the foreshore are entirely determined by the form and a characteristic length λ of the cross-section. This will be defined later for a number of different cases.
 - b) The water is characterized by the mass density ρ_w , the dynamic viscosity μ and the surface tension σ . The compressibility is not taken into consideration.
 - c) For an unambiguous definition of the wave motion as an independent variable, the motion which would occur in the absence of the slope or in the absence of reflection off the slope is considered characteristic. This is necessary because the reflection is partly dependent on the structure. Waves are termed regular if they are long crested and periodic in time. For a given gravitational acceleration g and period T , these waves may be characterized by a height H and an angle of incidence β at a given reference point with depth d , provided that the wave crests are straight and of constant height in deep water or in water of constant depth. If these criteria are not met, the variation in the propagation direction and the wave height along a crest must be indicated.

The dependent variable is the run-up height z , defined as the maximum height above the mean water level reached by a wave tongue running up against the slope. In spite of the fact that we are concerned here with regular waves, the experimental run-up is generally stochastic in nature with a narrow distribution. The distribution is not

considered in more detail. The average value is referred to as z .

The above considerations may be written symbolically as follows:

$$z = f(\text{shape of cross section}, \lambda, \rho_w, \mu, \sigma, g, d, T, H, \beta) \quad (\text{II.2.1})$$

This relationship is simplified by forming dimensionless groups. One possible combination is:

$$\frac{z}{H} = f(\text{shape of cross section}, \beta, \frac{H}{gT^2}, \frac{H}{d}, \frac{\rho_w H^2}{\mu T}, \frac{\rho_w H^3}{\sigma T^2}, \frac{H}{\lambda}) \quad (\text{II.2.2})$$

The independent dimensionless groups are sufficient to characterize the run-up subject to the limitations referred to above. The influence of each of the independent groups on the dependent group cannot, however, be determined by a dimensional analysis. More information is necessary for this purpose and it is generally obtained by theoretical and/or experimental means. In the case of wave run-up the greatest emphasis is placed on experiments.

II.3 THEORIES

II.3.1 Introduction

A distinction may be made between two categories of wave run-up theory: theories for waves which do not break and theories for breaking waves. These types of wave differ fundamentally.

Mathematical description of the propagation of a breaking wave is still only possible in the context of the non-linear long-wave theory in which the breaker is treated as a progressive shock wave. This theory is only applicable if the bed gradient is not steep. In the case of non-breaking waves, we are not tied to a long wave theory but may use a short wave (surface wave) theory in which no limitations need to be placed on the bed gradient or slope gradient. The lower the bed gradient and the smaller the depth in relation to the wave length, a short wave behaves more like a long wave. This enables a correlation to be established, as has been done, e.g. by Keller (1961) and Carrier (1966), between a short wave in deep water on the one hand and a long wave close to the water line on the other.

In applying one of the existing theories it is necessary to know whether the waves under consideration will break on the slope. A number of criteria are indicated for this purpose in the next section. Thereafter brief summaries are given in sections II.3.3 and II.3.4 of the fundamentals and results of the various theories for non-breaking and breaking waves. A similar summary has been prepared by Le Méhauté, Koh and Hwang (1968).

II.3.2 Breaking criteria

According to Iribarren and Nogales (1949) waves of perpendicular incidence on a plane, smooth slope with a gradient α will break on this slope if

$$\tan \alpha \leq \frac{8}{T} \sqrt{\frac{H}{2g}} \quad (\text{II.3.1})$$

H is the height of the wave at the assumed breaking point, where the depth is $\frac{1}{2} H$. This formula is only valid if the flat slope extends at least as far as the depth equal to H. By definition

$$L_0 = \frac{gT^2}{2\pi} \quad (\text{II.3.2})$$

Substitution of the above in equation II.3.1 gives

$$\tan \alpha \leq 2.3 \sqrt{\frac{H}{L_0}} \equiv \tan \alpha_{cr} \quad (\text{II.3.3})$$

or

$$\frac{H}{L_0} \geq 0.19 \tan^2 \alpha \equiv \left(\frac{H}{L_0}\right)_{cr} \quad (\text{II.3.4})$$

A graphic presentation of this will be found in figure II.3.1.

Iribarren and Nogales arrived at their criterion by semi-theoretical means. The experimental data presented by them and summarized in table II.3.1 show that the criterion gives the wave steepness half way between the limit of complete reflection and complete breaking. The steepness corresponding to incipient breaking is therefore less than $0.19 \tan^2 \alpha$. The values in the first and last column of the table are shown in figure II.3.1.

$\frac{H}{L_0}$	$\tan \alpha$		
	total breaking	total reflection	average
8.1×10^{-2}	0.42	0.86	0.64
3.4×10^{-2}	0.29	0.59	0.44
2.9×10^{-2}	0.33	0.49	0.41

Table II.3.1

Miche (1944) gives a linear theory for wave motion on a plane slope without a foreshore. The limit of breaking on the slope and also the limit of complete reflection is reached, according to Miche, when the water surface at the point of greatest run-up is just tangent to the slope facing. The water surface at the lowest point is then exactly perpendicular to the slope. This is shown in fig. II.3.2.

Criterion assumed for
incipient breaking: $\gamma = 0^\circ$
The corresponding $\delta = 90^\circ$.

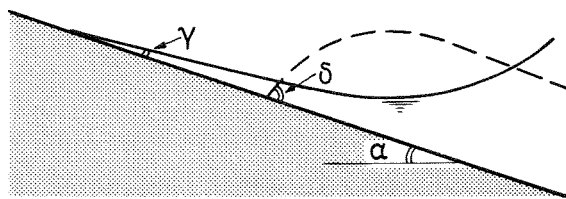

FIG. II.3.2

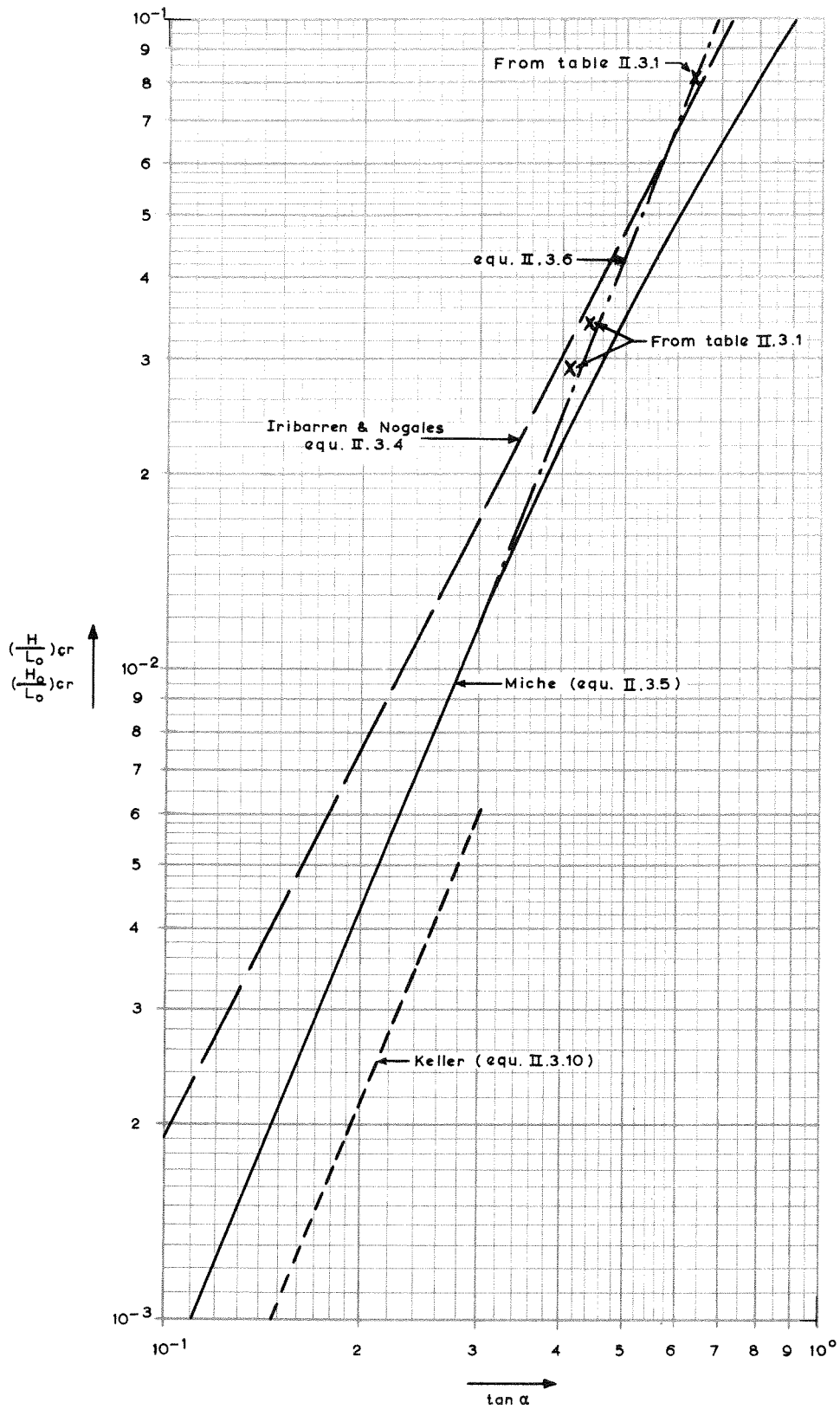

FIG. II. 3.1

The corresponding critical steepness is

$$\left(\frac{H_0}{L_0}\right)_{cr} = \frac{\sin^2 \alpha}{\pi} \sqrt{\frac{2\alpha}{\pi}} \quad \text{for } \alpha \leq \frac{\pi}{4} \quad (\text{II.3.5})$$

$$\left(\frac{H_0}{L_0}\right)_{cr} = \frac{1}{2\pi} \quad \text{for } \alpha = \frac{\pi}{2}$$

in which H_0 is the height of the oncoming wave on deep water. For gentle slopes ($\tan \alpha < 1:4$ approximately) equation II.3.5 may be written in the more practical form

$$\left(\frac{H_0}{L_0}\right)_{cr} = 0.25 (\tan \alpha)^{\frac{5}{2}} \quad (\text{II.3.6})$$

Equations II.3.5 and II.3.6 are shown in graphic form in figure II.3.1.

According to equation II.3.5 the critical steepness of the oncoming wave which would correspond to Miche's breaking criterion ($\gamma = 0^\circ$) is equal to $\frac{1}{2\pi}$ if the wall is vertical. This means that the standing wave would have a critical steepness of $\frac{1}{\pi}$. This value, (calculated by means of a linear theory) is on the high side. This is also apparent from the theory of Penney and Price (1952), experimentally confirmed by Taylor (1953), according to which the critical steepness of a standing wave on deep water is equal to 0.218. It is also apparent from these references that the tangents to the water surface on either side of the wave crest then form an angle of 90° and not of 0° as would be suggested by the criterion adopted by Miche. It follows from the above that for vertical walls the critical steepness according to Miche is too great by a factor of $(\frac{1}{\pi})/0.218 \approx 1.45$. The dependence of this correction factor on α is not known.

Keller (1961) gives a formula for the critical steepness which is derived for slopes which need only be plane in the vicinity of the water line. He used a non-linear long wave theory developed by Carrier and Greenspan (1958) for similar conditions. According to Carrier and Greenspan, the limit of breaking is reached when, with increasing wave steepness, the water surface becomes just vertical at some point. Keller expresses this condition in terms of the oncoming wave at a greater distance from the water line by connecting Carrier and Greenspan's theory with the linear short-wave theory. According to this theory, the following relationship applies in

two dimensional periodic wave motion over a bed with a gentle gradient:

$$\frac{H}{H_0} = K_s = (2n \tanh md)^{-\frac{1}{2}} \quad (\text{II.3.7})$$

in which H_0 is the (equivalent) wave height on (possibly fictitious) deep water, $m = 2\pi/L = 2\pi/(\text{local wave length})$ and

$$n = \frac{1}{2} + \frac{md}{\sinh 2md} \quad (\text{II.3.8})$$

K_s is the relative wave height known in English literature as the "shoaling coefficient". For the critical wave steepness Keller finds:

$$\left(\frac{H}{L_0}\right)_{cr} = \frac{\alpha^2}{2\pi} \sqrt{\frac{2\alpha}{\pi}} K_s \quad (\text{II.3.9})$$

Substitution of equation II.3.7 gives

$$\left(\frac{H_0}{L_0}\right)_{cr} = \frac{\alpha^2}{2\pi} \sqrt{\frac{2\alpha}{\pi}} \quad (\text{II.3.10})$$

which is also shown in figure II.3.1. This expression is very similar to that of Miche but there are some significant differences:

- Both formulae include H_0/L_0 , the wave steepness on deep water. While in the situation considered by Miche deep water is in fact present, this is not necessarily the case in Keller's formula where H_0 and L_0 are simply mathematical parameters.
- Keller's formula is derived for gentle slope gradients which may, however, vary in a profile. Miche's formula applies to a plane slope but is not limited to shallow gradients.
- Keller's formula is derived with the aid of a non-linear theory and Miche's formula by a linear theory. Since we are dealing with a breaking criterion the non-linear theory is probably better than the linear.
- The critical steepness according to Keller is approximately 0.5 times that determined by Miche.

II.3.3 Theories for run-up of non-breaking waves

A considerable number of publications are known in which the problem of the run-up of non-breaking waves is approached theoretic-

ally. The basic assumptions and results of these studies will be mentioned briefly below. Before looking at the work of individual authors, a number of more general points will be mentioned.

The theories all relate to an ideal fluid, i.e. one which is non-viscous. Most of them concern the propagation of regular waves over a plane, sloping bed as a two-dimensional problem. The short-wave theories for run-up are all linear. Some of the long-wave theories are non-linear. Generally a standing wave is considered. Two basically different solutions are possible, depending on whether the amplitude at the mean water line is finite or not. By superimposing these two solutions, a progressive wave is obtained with an amplitude which increases without bounds close to the water line. This is inevitable in the framework of an ideal-fluid approximation. For the run-up of non-breaking waves the only theories of interest are those relating to the standing wave with a finite amplitude at the position of the water line.

Table II.3.2 has been compiled to summarize the different theories. It indicates by author the nature of the problem considered (2- or 3- dimensional, progressive or standing wave etc.), whether or not a linearized theory has been used, and the slope profile to which this theory is applicable. Since this table is self-explanatory only a few supplementary observations are set out below.

Kirchhoff (1879), Pocklington (1921), Hanson (1926), Bondi (1943) Miche (1944) and Stoker (1947) give solutions applicable to the values of the slope angle meeting the criterion

$$\alpha = \frac{1}{q} \cdot \frac{\pi}{2} ; \quad q = 1, 2, 3 \dots \dots \dots \quad (\text{II.3.11})$$

Lewy (1946) has extended this to

$$\alpha = \frac{p}{q} \cdot \frac{\pi}{2} ; \quad p = 1, 3, 5 \dots \dots \dots ; \quad \frac{p}{q} < 2 \quad (\text{II.3.12})$$

The solutions given by these authors are all written in the form of a series in which the number of terms increases as the slope angle diminishes. To determine run-up (amplitude of vertical movement at the water line) Pocklington (1921) calculated the sum of these series; his result is

AUTHOR	YEAR	PROFILE	α DISCRETE	α CONTINUOUS	2-DIMENSIONAL	3-DIMENSIONAL	SHORT WAVE	LONG WAVE	LINEAR	NON-LINEAR	PERIODIC	NON-PERIODIC	STANDING WAVE ¹⁾	PROGRESSIVE WAVE ²⁾
Kirchhoff	1879	A	X		X		X		X		X		X	
Pocklington	1921	A	X		X		X		X		X		X	
Hanson	1926	A	X		X	X	X		X		X		X	
Bondi	1943	A	X		X		X		X		X		X	X
Miche	1944	A	X		X		X		X	x ³⁾	X		X	X
Lewy	1946	A	X		X		X		X		X		X	
Stoker	1947	A	X		X	X	X		X		X		X	X
Friedrichs	1948	A		X	X		X		X		X		X	X
Isaacson	1950	A		X	X		X		X		X		X	X
Peters	1950	A		X	X		X		X		X		X	X
Roseau	1951, '52	A		X		X	X		X		X		X	X
Peters	1952	A		X		X	X		X		X		X	X
Brillouet	1957	A	X		X		X		X		X		X	X
Carrier + Greenspan	1958	A		X	X			X		X	X	X	X	
Keller	1961	B		X	X		X	X	X	x ⁴⁾	X		X	
Keller + Keller	1964	C		X	X			X	X		X		X	
Wallace	1963 / '65	C	X		X			X		X		X		
Carrier	1966	B		X	X		X	X	X	x ⁴⁾	X	X		
Shuto	1967	A		X	X			X	X		X	X	X	X
Shuto	1968	A		X	X	X		X	X		X		X	X

PROFILE A

PROFILE B

PROFILE C

- 1) Standing wave with limited amplitude.
- 2) The progressive wave solution comprises two standing wave solutions with limited and unlimited amplitude at the water line.
- 3) Only valid for vertical walls
- 4) Only valid for long-wave theory

TABLE II.3.2

$$\frac{z}{H_0} = \sqrt{\frac{\pi}{2\alpha}} \quad (\text{II.3.13})$$

The same result was later also found by Miche and Lewy. The run-up increases as the slope angle diminishes.

The theories referred to above are difficult to use for gentle slope gradients because the number of terms in the series becomes very large. Miche (1944) and Friedrichs (1948) therefore determined an asymptotic approximation to the exact solution for gentle slope gradients. However, Miche's approximation formulas are only valid in the shallow areas. Friedrichs' formulas do not have this limitation. Friedrichs' result corresponds very closely to the usual approximation in which the local effect of the bed gradient is disregarded and a solution found as a succession of constant depth solutions connected to each other by the principle of a constant energy transport. Friedrichs' work may be regarded as a justification of this approach, which Miche claims to be valid as long as α does not exceed approx. 20° .

Isaacson (1950) uses Lewy's solution and proves that it is valid for any $\alpha < \pi$. Peters (1950) gives a more direct solution for all $\alpha < \pi$ without reference to p/q .

Hanson (1926) and Stoker (1947) give a solution to the problem of oblique incidence, for waves which reflect completely and for progressive waves. Their solutions are limited to the discrete values of α given by equation II.3.11. Roseau (1951, 1952) and Peters (1952) arrive in a completely different manner at a solution to the three dimensional problems valid for all $\alpha < \pi$.

The solution to the linear problem of the propagation of long-crested periodic waves in an ideal fluid over a flat bed has been practically completed by the work of these authors. More recent theories deal with non-linearities, in particular in the shallow area close to the water line, and propagation over beds which are not plane. Most of these theories are confined to gentle slopes. If it is not to break on slopes of this kind, the wave must not be steep.

Carrier and Greenspan (1958) use the non-linear long wave theory for a plane beach. They prove that there are solutions in which breaking does not occur. Their results relate on the one hand to non-periodic movements caused by first deforming the water surface and then releasing it without initial velocity, and on the other to a more realistic

periodic movement. They start from equations in Eulerian coordinates and reach a solution by means of a suitably chosen coordinate transformation. Shuto (1967) reached the same result in a more direct manner by working with equations in the Lagrangian system. This method was later used by Shuto (1968) to calculate the run-up of long oblique waves.

Keller (1961) applied the linear long-wave theory to wave movements at the water line where the slope is assumed to be plane. This movement is connected to the movement at greater depth by using the simplified short wave theory, i.e. neglecting all local influences of the bed gradient. His result is therefore applicable to non-plane beds provided that the gradient is not too steep. The run-up is given by:

$$\frac{z}{H} = \frac{1}{K_s} \sqrt{\frac{\pi}{2\alpha}} \quad (\text{II.3.14})$$

in which K_s is the shoaling coefficient defined in equation II.3.7, so that equation II.3.14 can be expressed in the equivalent deep water wave height H_0 :

$$\frac{z}{H_0} = \sqrt{\frac{\pi}{2\alpha}} \quad (\text{II.3.15})$$

This formula is the same as Pocklington's (1921). Keller also applied the above procedure using the non linear theory of Carrier and Greenspan (1958) in the area close to the water line. Surprisingly, the result is exactly the same as far as run-up is concerned.

Keller and Keller (1965) considered the case of a plane slope adjoining a horizontal foreshore. They use the linear long-wave theory in the whole area with the result:

$$\frac{z}{H} = \left\{ J_0^2 \left(\frac{4\pi}{\alpha T} \sqrt{\frac{d}{g}} \right) + J_1^2 \left(\frac{4\pi}{\alpha T} \sqrt{\frac{d}{g}} \right) \right\}^{-\frac{1}{2}} \quad (\text{II.3.16})$$

in which J_0 and J_1 are Bessel functions of the zero and first order respectively. For high values of their arguments, asymptotic approximations may be used for the Bessel functions. Equation II.3.16 then tends towards

$$\frac{z}{H} \approx \sqrt{\pi} \left(\frac{2\pi}{\alpha T} \sqrt{\frac{d}{g}} \right)^{\frac{1}{2}} \quad (\text{II.3.17})$$

Figure II.3.3 represents both relationships in graphic form.

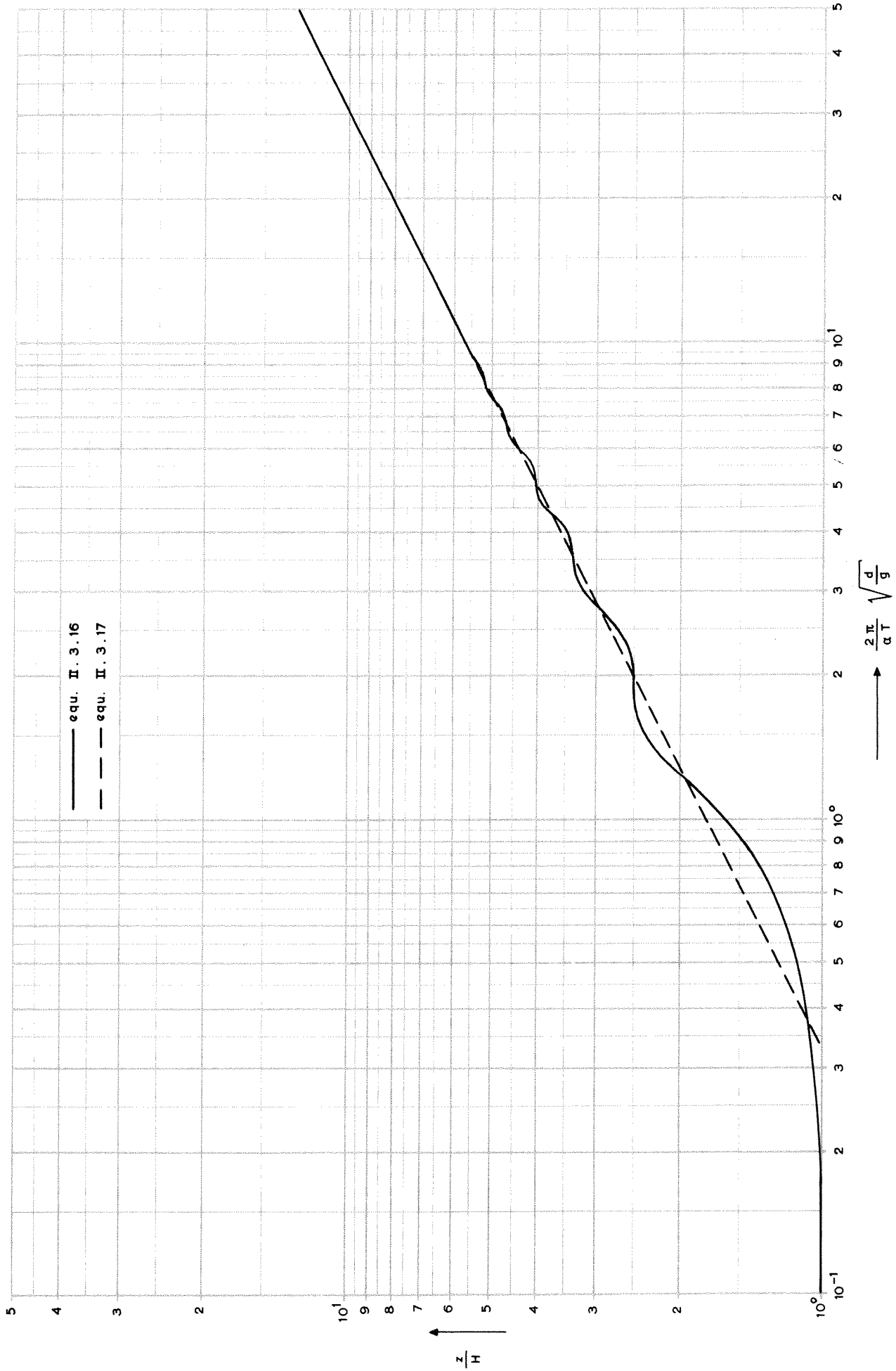

FIG. II. 3.3

For a sufficiently small depth, equation II.3.14 should give the same result as equation II.3.16. In shallow water ($d/gT^2 <$ approx. 0.005)

$$K_s = \left(2n \tanh \frac{2\pi d}{cT}\right)^{-\frac{1}{2}} \approx \left(2.1 \frac{2\pi d}{T\sqrt{gd}}\right)^{-\frac{1}{2}} \quad (\text{II.3.18})$$

so that equation II.3.14 leads directly into equation II.3.17. As is shown by figure II.3.3 there is a good agreement with equation II.3.16 for $\sqrt{d/g}/\alpha T > 1$.

Wallace's theory (1963, 1964, 1965) relating to solitary waves is referred to here in the context of theories for periodic waves because in some instances the solitary wave may be considered as a limiting case of a periodic wave. Wallace gives a description which must be worked out numerically. For vertical walls (1964) he finds by approximation, if $H/d >$ approx. 0.15,

$$\frac{z}{H} = 2.5 \quad (\text{II.3.19})$$

Carrier (1966) considers the example of the propagation of the dispersive wave train generated by a given movement of part of the bed during a specific period of time. He gives an approximation formula for the run-up in a special instance of bed movement of this kind.

Van Dorn (1966) and Le Méhauté, Koh and Hwang (1968) indicate empirical methods of determining non-linear influences on wave run-up. Van Dorn uses the linear equations but replaces H by twice the height of the crest of the oncoming wave above the mean water level, calculated by a Stokes theory or a cnoidal theory. From these theories he has derived a nomogram indicating the relative crest height.

Le Méhauté et al start from a standing wave against a vertical wall where

$$\frac{z}{H} = 1 + \Delta \quad (\text{II.3.20})$$

The term Δ is the relative super elevation of the crest caused by non-linear effects and is given by Miche (1944) up to the second order as

$$\Delta = \frac{1}{2} mH \left(1 + \frac{3}{4} \sinh^{-2} md - \frac{1}{4} \cosh^{-2} md \right) \coth md \quad (\text{II.3.21})$$

Le Méhauté et al assume that the non-linear influences on run-up on a slope which is not too gentle can be approximated by assuming that

$$\frac{z}{H_0} = \sqrt{\frac{\pi}{2\alpha}} + \Delta \quad (\text{II.3.22})$$

The theories referred to above for run-up of non-breaking waves indicate that run-up increases as the slope angle decreases. However, if the slope angle falls below the critical value, which is dependent on the wave steepness, the wave will break on the slope and these theories will cease to be valid.

II.3.4 Theories for run-up of breaking waves

As already stated in the introduction to this chapter, breaking waves may be described with the aid of a non-linear long-wave theory, provided they have the characteristic of a bore (moving shock wave, moving hydraulic jump). In this connection, use is made of integration by means of characteristics. Stoker (1948, 1949, 1957) drew attention to this possibility.

After Stoker various authors applied this method to the problem of run-up of a breaking wave. In general they studied how a bore with given (assumed) characteristics is propagated through initially still water of decreasing depth as outlined in figure II.3.4. The influence of preceding waves is not taken into account here. In most cases an ideal fluid is assumed. (Energy losses do occur in a bore but the details of what happens in a bore are not considered.) The results obtained by the various authors are not so much explicit expressions of wave run-up as methods by means of which incidental cases can be calculated.

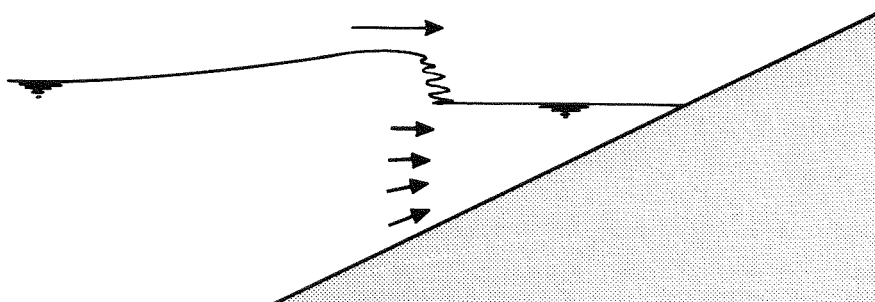

FIG. II.3.4

Greenspan (1958) and Jeffrey (1964) use the characteristic method to determine the point at which a given oncoming wave will break. Kishi (1962) has also considered this problem.

Whitham (1958) gives an approximation method to calculate the non-uniform propagation of a shock wave. Keller, Levine and Whitham (1960) carried out a number of calculations which appear to confirm the validity of Whitham's approximation. They developed the method for the transformation of a bore over a sloping bed. This was also done by Kishi (1962).

Ho and Meyer (1962), Shen and Meyer (1963) and Ho, Meyer and Shen (1963) give a mathematically based qualitative description of the behaviour of a bore as it runs up. They examined a number of properties of possible solutions to the long-wave equations with a plane slope. Because they only introduce a very small number of secondary conditions, their observations may be applicable to a large number of instances. The general nature of these observations means however that their work must be viewed primarily in qualitative terms. Some of their conclusions are as follows:

- the form of the bore and of the velocity at the water line are practically independent of the initial conditions;
- near the water line the bore height approaches zero (this had also been found by Keller, Levine and Whitham);
- beyond the water line run-up takes place in the form of a thin layer of water which becomes increasingly thin as time passes;
- the greatest run-up is at most equal to the velocity head $U^2/2g$ of the water at the water line when the bore reaches this point, but "no method is presently available for estimating the value of U from the properties of swell far from the shore".

In the conventional long-wave theory a non-breaking positive wave becomes a bore because the front becomes steeper. This theory does not allow for an intermediate phase in the form of a spilling breaker (see figure II.3.5). Le Méhauté (1962) attempted to overcome this drawback. He gave a semi-theoretical account of the energy balance for a spilling breaker partly based on the solitary wave theory. With a sufficiently steep bed gradient, this type of breaker becomes a fully developed bore. Le Méhauté further supplements the equations presented by Stoker as follows:

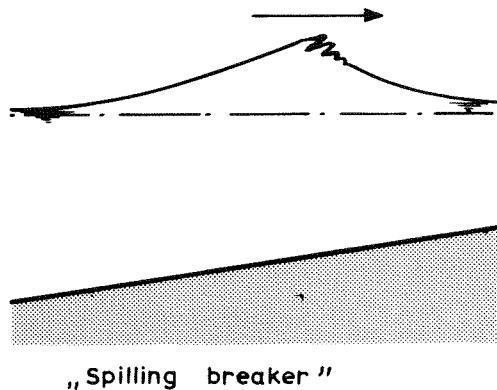

„Spilling breaker“

FIG. II. 3.5

- a stabilizing term in the equation of motion related to the curvature of the stream lines (Boussinesq term);
- a resistance term;
- other initial conditions which give greater accuracy for the final result.

Freeman and Le Méhauté (1964) give a detailed account of the behaviour of the wave at the water line and during run-up. Resistance is only considered during run-up as such, i.e. past the mean water line. The results are dependent on two coefficients including a resistance factor. Freeman and Le Méhauté do not give numerical values for these coefficients. The calculations must therefore be supplemented by measurements.

Calculations by Le Méhauté and Moore (1965) use both the exact integration method and the approximation proposed by Whitham (1958). The differences between the results were considerable.

Kishi (1966) gives a different method from that of Le Méhauté for calculation of an incompletely developed bore. He bases his work on that of Whitham (1958) and Keller et al (1960).

Amein (1966) summarizes the methods available to calculate the run-up of shallow water waves. He takes his boundary conditions from the linear short-wave theory. In shallow water he changes over to the non-linear long wave theory. The propagation of waves is also calculated by the characteristic method with some modifications in the area past the water line, i.e. where the actual run-up takes place. Amein does not consider resistance because he believes that unrealistic results are obtained if a resistance term is introduced according to existing formulae. Unlike the other authors he considers

periodic waves. A number of calculations show that the run-up increases with the wave period.

The propagation of periodic waves over a slope has been studied by Daubert and Warluzel (1967) as well as by Amein. They use the non-linear long-wave equations including a resistance term according to Chézy. For numerical integration, the equations are not used in characteristic form but directly converted into difference equations. The initial condition is the state of equilibrium. On the seaward side, a harmonic movement is introduced corresponding to an oncoming wave. The first wave which reaches the coast runs up against a dry slope and reaches a much greater run-up height than the following waves run up against water flowing back. (The extent to which this occurs and is a relevant factor generally depends on the waves steepness and slope gradient.) After some time but not before the first reflected wave has reached the seaward side, a periodic movement sets in. An example is given of a wave with $T = 2$ sec, and $H = 0.10$ m at a depth of 0.40 m running up against a slope at 1 : 5. The calculated run-up length along the slope was 0.85 m; 0.80 m was measured in a model.

It is interesting to compare these figures with the empirical run-up formula for breaking waves given by Hunt (1959);

$$z = \sqrt{HL_0} \tan \alpha \quad (\text{see equation II.5.8, page 47})$$

The run-up length calculated in this way is 0.82 m.

II.4 QUALITATIVE EXPERIMENTAL RESULTS

II.4.1 Introduction

In a number of countries experiments have been carried out for several years relating to wave run-up, especially in Germany, Japan, the Netherlands, Russia and the United States. The differences in geographical conditions are reflected in the wave run-up problems which are studied. The wave run-up formulae prepared in the Netherlands and Russia are only valid for steeper waves. On the other hand, in the United States waves with low steepness are not insignificant because of the long distances and fetches on the oceans; in run-up studies waves with very low steepness have therefore also been considered. In Germany the foreshore is often included in the run-up studies. In addition, one country may have a basically different type of coastal defence structure from another. For instance, Japanese literature on wave run-up refers relatively frequently to (almost) vertical walls, i.e. sea walls, sometimes protected by stacked concrete blocks. Although there are therefore differences in the direction of research in the various countries, the literature consulted shows a sufficient degree of concordance on a number of points for certain general conclusions to be drawn. To the extent that these merely represent a general reproduction of the observations contained in the various sources, no separate source indication will be given. Instead reference is made to the bibliography at the end of this part (page 84).

Before going on to present numerical results, the influence of the dimensionless groups given in Chapter II.2 will be discussed from the qualitative point of view. In this connection, the value of one group is always varied while those of the other groups are maintained constant. Consideration is given only to a smooth plane slope with a gradient angle α which may or may not adjoin a horizontal foreshore. In this instance

$$\frac{z}{H} = f\left(\alpha, \beta, \frac{H}{gT^2}, \frac{H}{d}, Re, We\right) \quad (\text{II.4.1})$$

in which

$$Re = \frac{\rho_w H^2}{\mu T} \quad (\text{II.4.2})$$

a Reynolds number, and

$$We = \frac{\rho_w H^3}{\sigma T^2} \quad (\text{II.4.3})$$

a Weber number.

II.4.2 Slope angle α

As long as the wave breaks on the slope, i.e. as long as $\alpha < \alpha_{cr}$, z/H increases with α while z/H diminishes again for $\alpha > \alpha_{cr}$. The latter agrees with the run-up theories for non-breaking waves. Clearly z/H is at its highest when $\alpha = \alpha_{cr}$. The dependence of z/H and α is indicated in figure II.4.1.

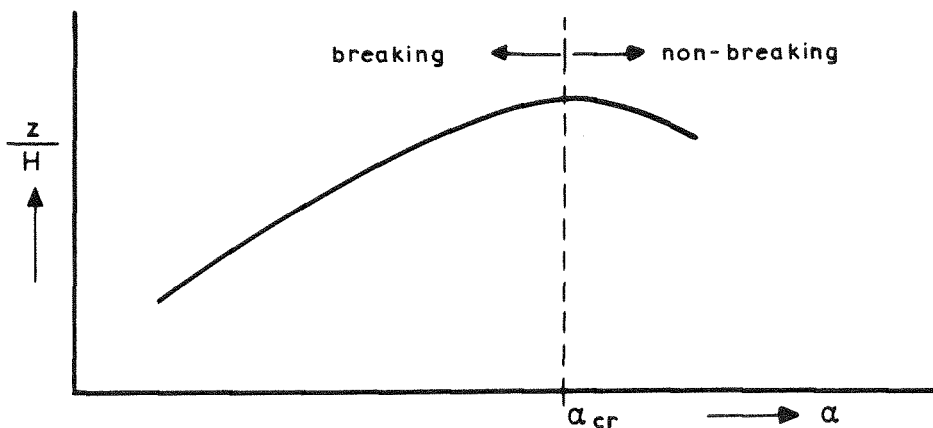

FIG. II.4.1

II.4.3 Angle of incidence β

The overwhelming majority of observations of wave run-up relate to perpendicular incidence. The limited data on oblique incidence indicate a reduction in z/H when the direction of incidence deviates to a greater extent from the perpendicular.

II.4.4 Wave steepness H/gT^2

In the case of steepness values which are so low that the waves do not break, a number of research workers have arrived at results which are not altogether identical concerning the influence of the wave steepness. Some observers claim that there is no dependence while others suggest that z/H increases slowly with rising

steepness. Clearly z/H is not particularly sensitive to wave steepness as long as no breaking occurs.

From the qualitative point of view it is easy to explain why z/H should increase with steepness as long as the wave does not break. In this case reflection is practically complete. In the event of reflection against a wall the run-up height is equal to the greatest height above the mean water level of the resulting standing wave at the position of the wall. In the case of both standing and progressive waves, the relative height of the crest above the mean water line increases the greater the wave steepness. This is a non-linear effect.

The influence of steepness on z/H is much greater for breaking waves than for non-breaking waves. With increasing steepness z/H diminishes distinctly. The explanation of this may be found in the fact that the breaking process becomes more intensive with increasing wave steepness, which apparently more than compensates the super-elevation of the crest of the oncoming wave referred to earlier.

The variation in z/H as a function of wave steepness is outlined in figure II.4.2.

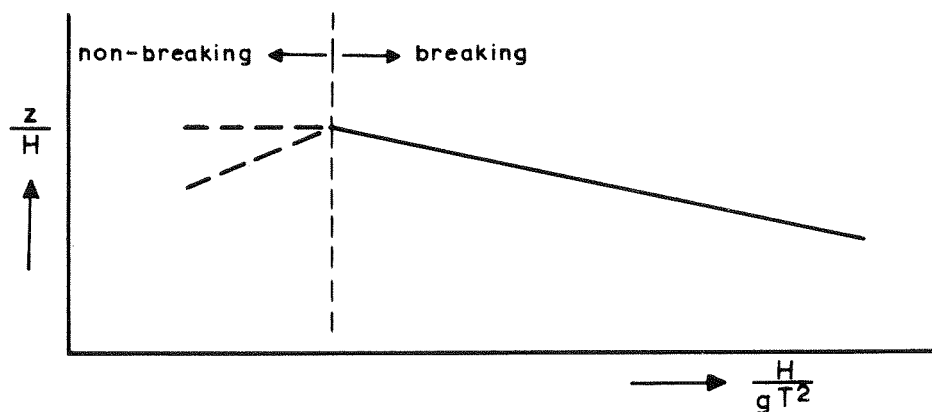

FIG. II. 4. 2

II.4.5 H/d ratio

The influence of H/d on z/H is dependent on whether or not the wave breaks on the slope. In the case of waves which do not break H/d has a slight influence on z/H , such that z/H increases with H/d , provided that $H/d > \text{approx. } 1/3$. A possible explanation of this can be found in the fact that, as with increasing wave steepness.

with increasing H/d values a higher relative elevation of the crest above the mean level occurs.

If the conditions are such that the wave breaks, H/d will have practically no influence on z/H . If the wave still just fails to break on the foreshore, H/d will have reached its maximum value; this depends on the wave steepness so that $(H/d)_{\max}$ may not be considered as an independent variable.

The combined influence of wave steepness and H/d on z/H may be formulated as follows: for a given α , z/H reaches a maximum for the combination of wave steepness and H/d at which the wave just breaks at the toe of the slope.

II.4.6 Reynolds number Re

The influence of the Reynolds number on a flow is generally greater the smaller the Re value and the more streamlined the boundaries of the flow. In scale experiments of wave run-up on a smooth, plane slope where Re is smaller than in the prototype, a scale effect should therefore occur dependent on the magnitude of Re . A smaller value for Re in the model implies that the effect of viscosity is relatively greater. This results in too low a run-up in the model. This aspect has been studied in the United States. The provisional conclusion was that a significant scale effect in fact existed for many values of Re occurring in prototypes and models. The C.E.R.C. handbook (1966) recommends corrections of up to 20% as a function of the steepness of the wave and slope. These corrections are, however, based on a very small amount of data and therefore not altogether reliable.

II.4.7 Weber number We

Surface tension only plays a significant role in the run-up phenomenon if We is below a certain value. Because the surface tension is not reproduced to scale, significant scale effects may occur in small models in respect of the breaking of waves. Since the run-up phenomenon is very closely related to the breaking of the wave, this point must be borne in mind.

II.5 QUANTITATIVE EXPERIMENTAL RESULTS

II.5.1 Introduction

In compiling a summary for use in the Netherlands of available quantitative experimental results, it is desirable to place the emphasis on data which may be important to conditions prevailing in the Netherlands. The observations in the preceding chapter show that the emphasis must be placed on the run-up of waves which break on the slope. Most data relate to waves of perpendicular incidence on a smooth, plane slope. These will be dealt with in the next section. Run-up on rough and non-plane slopes will be discussed in subsequent sections.

II.5.2 Smooth, plane slope

In the United States a large number of experiments have been conducted with regular waves (Saville, 1956). The results are reproduced in graphic form in the C.E.R.C. handbook (1966). Figures II.5.1 and II.5.2 are taken from this publication. The relative run-up z/H_0 is plotted against $\cot \alpha$ with the wave steepness H_0/gT^2 as a parameter. The right-hand branch of each line relates to waves breaking on the slope and the left-hand branch to waves which do not break. In figures II.5.1 and II.5.2 a line has been drawn at the point of transition between the two branches. Along this line there is a relation between wave steepness and slope gradient. This relationship turns out to be the same as that expressed by equation II.3.6, for all wave steepnesses considered; this equation was proposed by Miche (1951) as an approximation for his breaking criterion (eq.II.3.5) for steepness values below approx. 1%.

The relative run-up z/H_0 of waves breaking on the slope appears to increase with decreasing wave steepness; with constant wave steepness the run-up is then approximately proportional to $\tan \alpha$.

In a summary of run-up data Franzius (1965) converted the original data used in the C.E.R.C. graphs and expressed the relative run-up z/H in a formula as a function of α , H/d and H/L . The usefulness of this is doubtful since Franzius' formulae are too complicated to be remembered easily; in addition it takes a great deal more time to calculate run-up by means of the formulae than to determine it with the aid of the original graphs. For the record, however, they are set out below:

$$\frac{z}{H} = \sin \alpha (5.95 \tan \alpha + 1.5) \left(\frac{0.123L}{H} \right) \left\{ \sqrt{\frac{H}{d}} (1.58 - 2.35 \tan \alpha) + 0.092 \cot \alpha - 0.26 \right\}$$

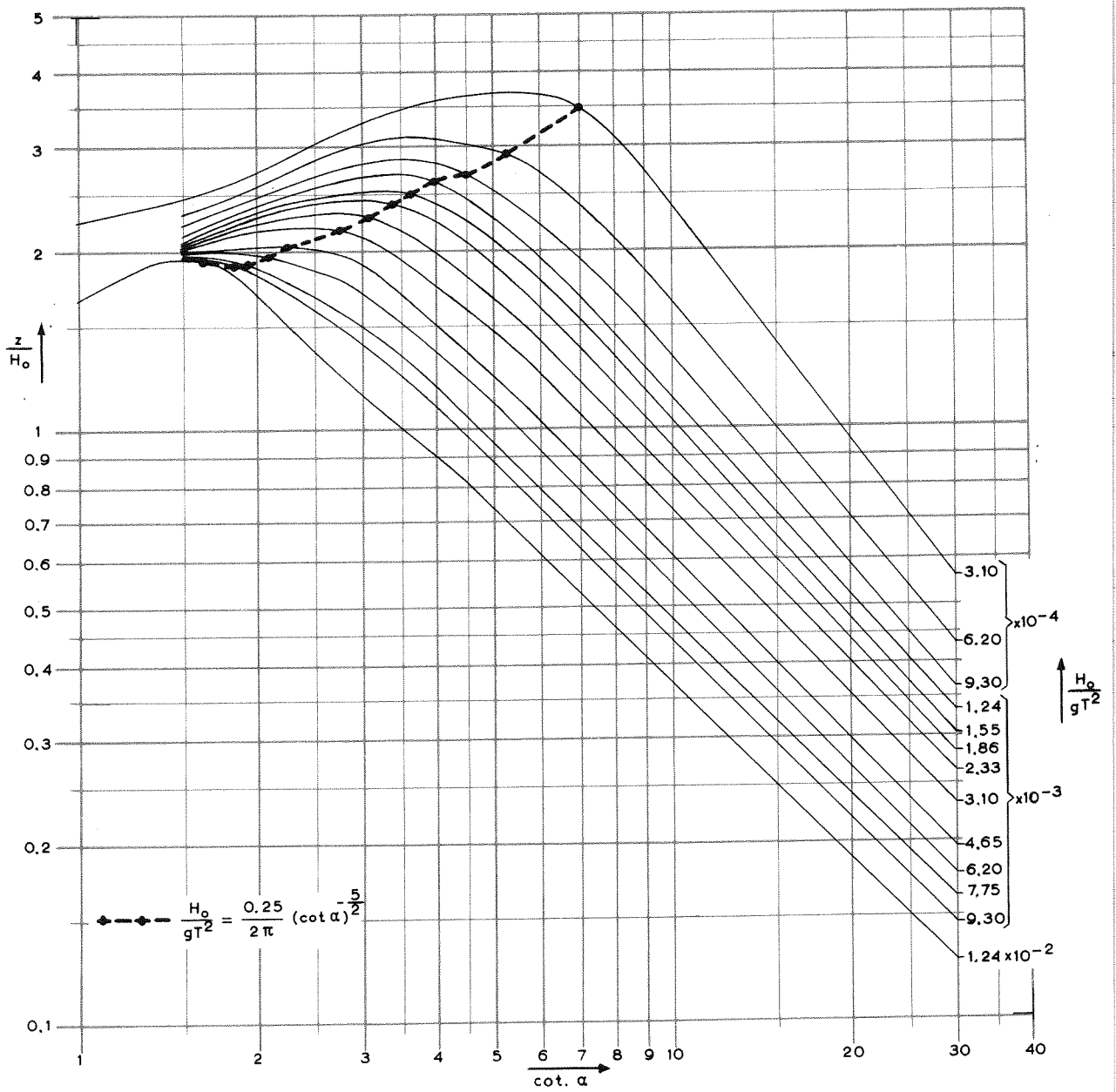
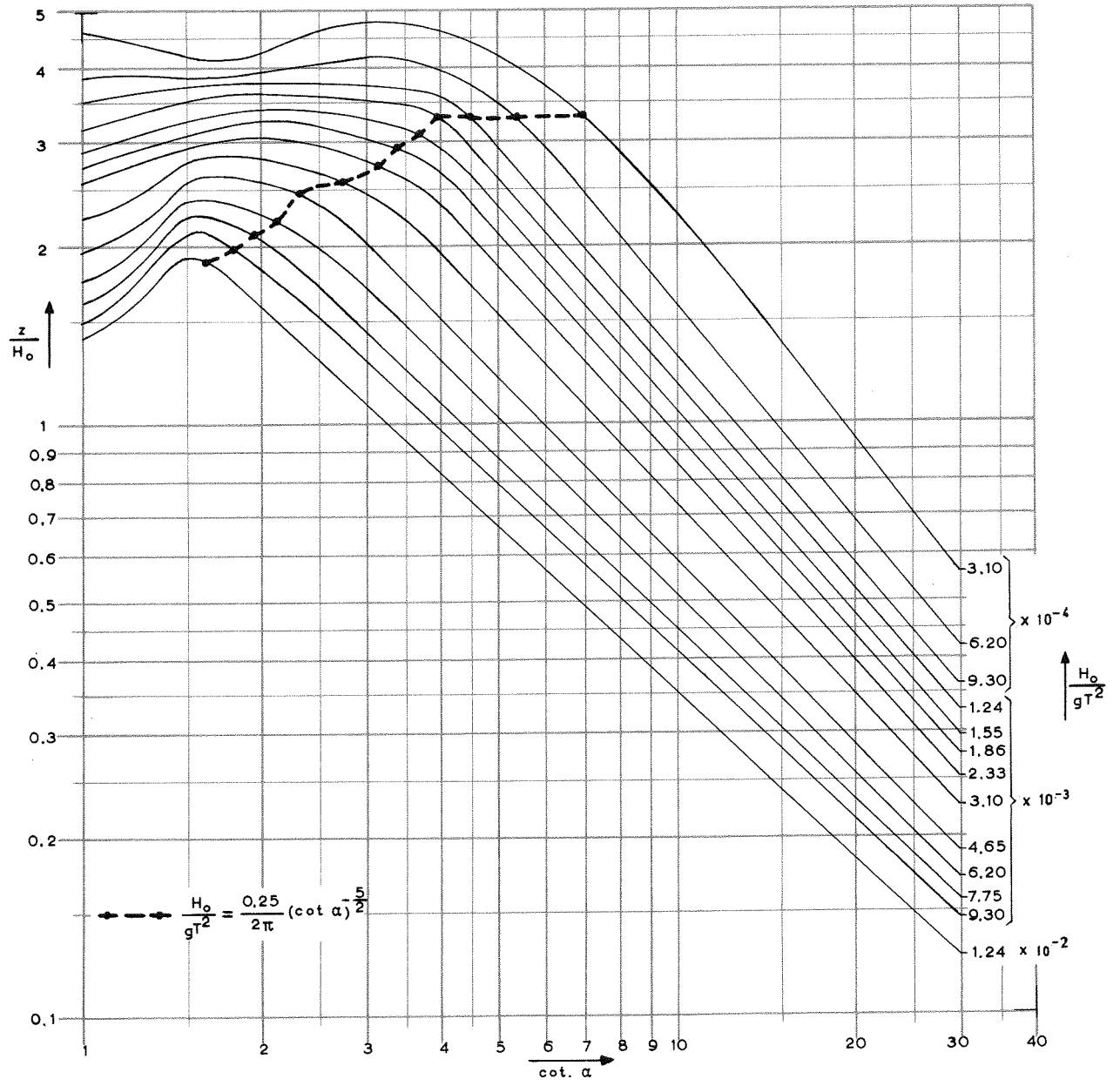

FIG. II. 5.1



$$1 < \frac{d}{H_0} < 3$$

FIG. II. 5. 2

$$\text{for } \frac{1}{6} \leq \tan \alpha \leq \frac{1}{2.25} \text{ and } \frac{H}{d} \leq 0.475 \quad (\text{II.5.1})$$

$$\frac{z}{H} = 2.3 \left(\frac{0.123L}{H} \right)^{(0.56\sqrt{\frac{H}{d}} - 0.18)} \text{ for } \tan \alpha = 1:1.5 \quad (\text{II.5.2})$$

$$\frac{z}{H} = 0.21 \left(\frac{0.123L}{H} \right)^{(0.95\sqrt{\frac{H}{d}} + 0.43)} \text{ for } \tan \alpha = 1:10 \quad (\text{II.5.3})$$

Franzius also conducted model experiments to test the formulae independently and thus also indirectly verify the American data. The result was satisfactory.

The complicated nature of the above expressions is explained by the fact that Franzius wished to cover the whole area of breaking and non-breaking waves in a single type of formula. By confining consideration to breaking waves, it is possible to obtain much simpler formulae, as Hunt (1959) did. On the basis of the American model tests he found that z/H is proportional to $\tan \alpha$, to $(H/L)^{\frac{1}{2}}$ and to $(\tanh 2\pi d/L)^{-\frac{1}{2}}$, or

$$\frac{z}{H} = \text{constant} \times \tan \alpha \left(\frac{H}{L} \right)^{\frac{1}{2}} (\tanh \frac{2\pi d}{L})^{-\frac{1}{2}} \quad (\text{II.5.4})$$

which after substitution of

$$L = L_0 \tanh \frac{2\pi d}{L} \quad (\text{II.5.5})$$

gives

$$\frac{z}{H} = \text{constant} \times \frac{\tan \alpha}{\sqrt{\frac{H}{L_0}}} \quad (\text{II.5.6})$$

The constant was also determined by Hunt from the model experiments. However, his final formula is not dimensionally homogeneous. If the formula is restored to the dimensionless form, the constant in equation II.5.6 becomes 1:

$$\frac{z}{H} = \frac{\tan \alpha}{\sqrt{\frac{H}{L_0}}} \quad (\text{II.5.7})$$

or

$$z = \sqrt{HL_0} \tan \alpha \quad (\text{II.5.8})$$

Although Hunt's formula lacks any theoretical basis it is possible to find a plausible explanation for the form in which g , H , T and α occur in it. For this purpose equation II.5.8 is rewritten as

$$z = 0,4 T \sqrt{gH} \tan \alpha \quad (\text{II.5.9})$$

in which use is made of equation II.3.2.

The formula relates to waves breaking on the slope. Consideration is given to the water particles which run up the slope while the wave is breaking and after it has broken. The initial velocities of these particles, i.e. their velocities shortly after breaking, are of the same order of magnitude as the velocities during breaking. The horizontal particle velocities in a breaking wave are in the order of \sqrt{gH} . The initial velocities of the water masses as they run up in the horizontal direction are therefore also in the order of \sqrt{gH} . The movement is periodic with a period T . If the form of the velocity as a function of time is approximately independent of the characteristics of the wave and slope, the horizontal particle excursions are in the order of $T \sqrt{gH}$, and the vertical excursions, including run-up, in the order of $T \sqrt{gH} \tan \alpha$. According to equation II.5.9 the latter is in fact the case.

Attention is drawn to the fact that the above observations do not confirm the accuracy of Hunt's formula. They are intended as a possible interpretation of it, which may help to give greater insight into its structure.

In figure II.5.3, some unpublished data of the Delft Hydraulics Laboratory are compared with equation II.5.9. It is striking that the points for which $\cot \alpha = 6$ not only coincide better with II.5.9 but are also better correlated among themselves than the points for which $\cot \alpha = 4$.

Franzius (1965), Drogosz-Wawrzyniak (1965) and Wagner (1968) give a number of Russian run-up formulae. These are quoted below together with two formulae proposed by Drogosz-Wawrzyniak and Wagner themselves. Most of these formulae are based on model measurements. An indication to the contrary is given when that is not the case. The limits are also indicated within which the wave steepness and slope gradient were varied in the model tests.

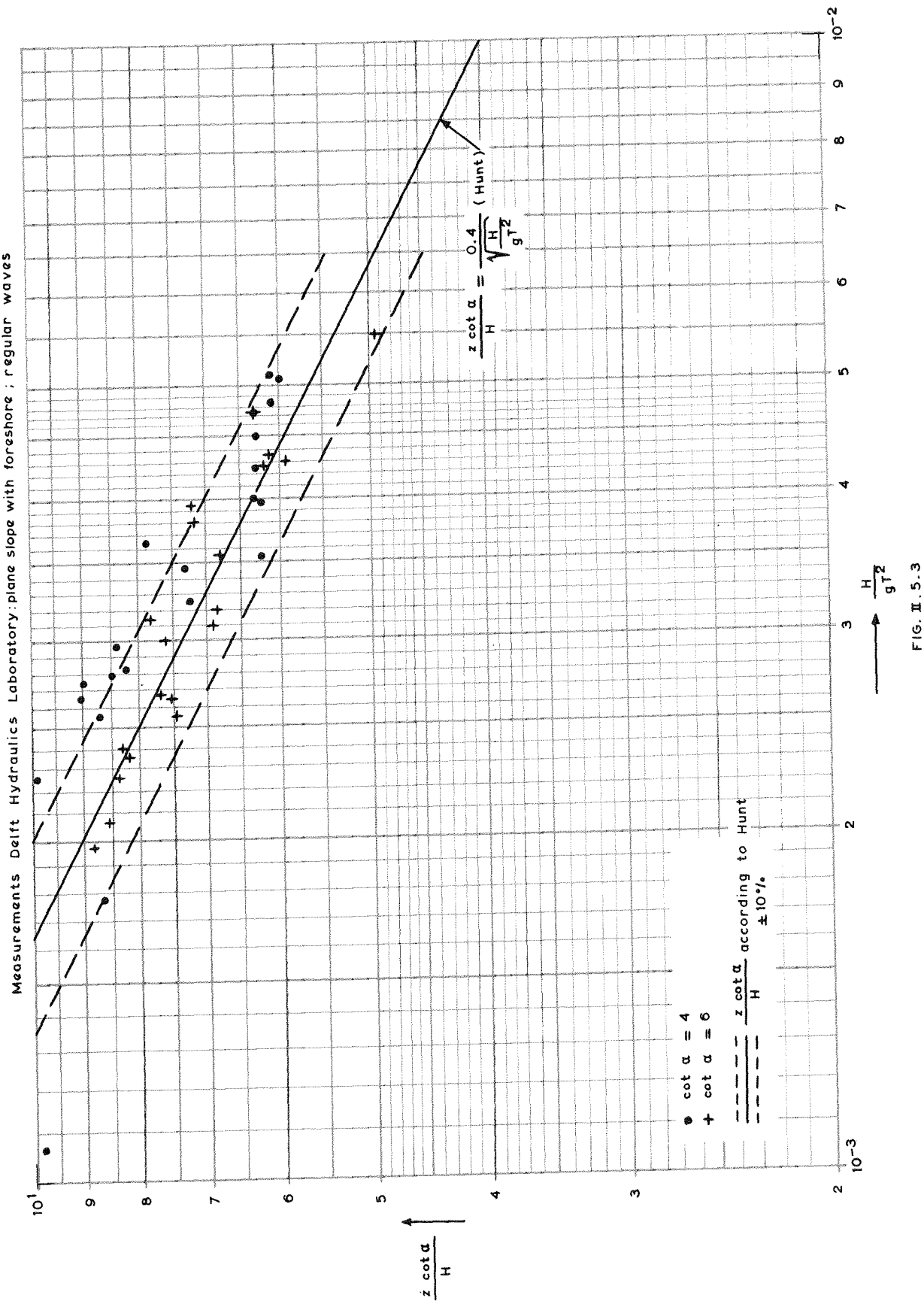

FIG. II. 5.3

Djounkowski (1940): $z = 3.2 H \tan \alpha$ (II.5.10)
 $1 \leq \cot \alpha \leq 4$
 $0.09 \leq \frac{H}{L} \leq 0.10$

Drogosz-Wawrzyniak (1965): $z = 3.8 H \tan \alpha$ (II.5.11)
 $\frac{H}{L} = 0.067$

Karapetjan: $z = (3 + 0.2 \frac{L}{H}) H \sin \alpha$ (II.5.12)
 $\cot \alpha = 3, 5, 10$

Kultshiski (1956) $z = (3.2 + 9.6 \sin \alpha) H \tan \alpha$ (II.5.13)
 $0.06 \leq \frac{H}{L} \leq 0.10$

Kurlowitz (1957): $z = H^{0.1} \sqrt{HL} \tan \alpha$ (II.5.14)
 $2 \leq \cot \alpha \leq 5$
 $0.06 \leq \frac{H}{L} \leq 0.10$

Maksimcuk (1959): $z = \sqrt{HL} \sin \alpha$ (II.5.15)

Pishkin (1941, 1954): $z_{\max} = 5.6 H \tan \alpha$ (II.5.16)
 $1 \leq \cot \alpha \leq 6$
 $0.05 \leq \frac{H}{L} \leq 0.10$

Pishkin's formula relates to "the" maximum run-up.

Shankin (1955):

$$z = 1.4 \frac{1.35 + 0.585 \sqrt{\frac{L}{H}}}{0.25 + \cot \alpha} H \quad (\text{II.5.17})$$

$$1.5 \leq \cot \alpha \leq 5$$

$$0.055 \leq \frac{H}{L} \leq 0.11$$

The form in which H , L and α appear in the formula is determined in the model. The magnitude of the coefficient of proportionality is based on model measurements and measurements under natural conditions.

Sidorowa (1957):

$$z = (1.5 + 0.25 \frac{L}{H}) H \tan \alpha \quad (\text{II.5.18})$$

$$2 \leq \cot \alpha \leq 6$$

$$0.03 \leq \frac{H}{L} \leq 0.10$$

Zukovec and Zajev (1960):

$$z = 2 \sqrt[3]{\frac{L}{H}} H \tan \alpha \quad (\text{II.5.19})$$

$$\cot \alpha \geq 1.5$$

This formula has also been attributed to Shankin. It appears in Russian manuals.

In addition to the above formulae, Drogosz-Wawrzyniak mentions measurements by Suzdalcew (1964). The results were generally the same as those obtained by Saville (1956).

To enable the formulae referred to above to be compared with each other, $z/H \tan \alpha$ is plotted against H/L in figure II.5.4. The equation II.5.17 formulated by Shankin is first written as

$$z = \frac{1.9 + 0.82 \sqrt{\frac{L}{H}}}{0.25 \tan \alpha + 1} H \tan \alpha \quad (\text{II.5.20})$$

For $4 \leq \cot \alpha \leq 12$, the denominator assumes values between 1.02 and 1.06. If the denominator is taken as equal to 1.04 an error of at most 2% is made in this range of α values. The equation II.5.20 then becomes

$$z \approx (1.82 + 0.79 \sqrt{\frac{L}{H}}) H \tan \alpha \quad (\text{II.5.21})$$

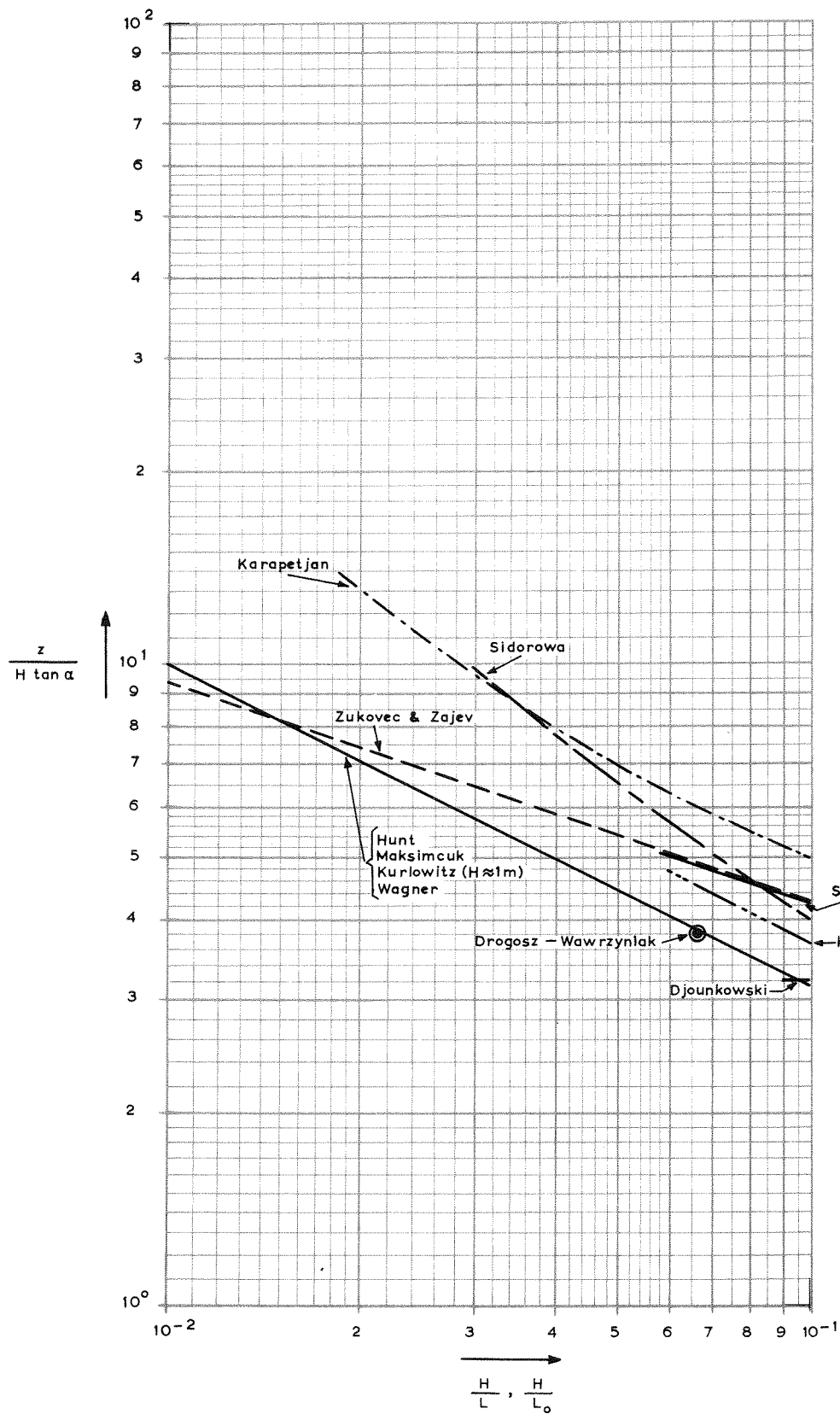

FIG. II. 5. 4

In addition, in equations II.5.12 and II.5.15, $\sin \alpha$ is assumed identical to $\tan \alpha$. As long as $\tan \alpha < 1:3$ the maximum error is 5%.

Figure II.5.4 shows that there are considerable differences between the curves. The formulae of Sidorowa and Karapetjan above all differ considerably from the others. Equation II.5.19 seems to give much the same results as equation II.5.21.

In a number of Russian formulae the wave length L occurs. To enable them to be compared with Hunt's formula in which L_0 occurs, it is necessary to know the ratio L/L_0 in the experiments from which the above formulae are derived. Drogosz-Wawrzyniak indicates the characteristics of the waves used by various authors. These data are not available for Kultshiski, Kurlowitz and Sidorowa. In most other cases, L was identical to or differed only by a few percent from L_0 . Equations II.5.10 to II.5.21 can therefore be compared with Hunt's equation II.5.8. Kurlowitz' equation II.5.14 coincides with this if $H \approx 1$ m, as does Maksimcuk's equation II.5.15 if $\cos \alpha \approx 1$. Figure II.5.4 also shows that in the range for which they are valid Djounkowski's and Drogosz-Wawrzyniak's run-up formulae coincide with Hunt's formula.

The question now arises as to whether the Russian formulae based on experiments with deep water waves remain valid in shallow water where L is significantly smaller than L_0 . This problem appeared in the case of Franzius (1965) although he did not recognize it as such. He found that the run-up calculated according to equations II.5.14, II.5.17 and II.5.19 was significantly lower than the measured run-up. In his calculation, he used L which varied in the experiments between $0,42 L_0$ and $0,72 L_0$. If, on the other hand L_0 is substituted in the formulae, they coincide reasonably well with the model results. Kurlowitz's formula and that of Hunt are thereby found to give values which are up to approx. 20% lower than the measured values for higher wave steepness levels. In the light of these results it may be assumed that the expression L in the Russian formula represents the deep water wave length.

Wagner (1968), working from a differential equation with a quadratic resistance term, reached the following result for the run-up of breaking waves:

$$\frac{z}{H \sin \alpha} = K_1 \sqrt{\frac{L}{H} \coth \frac{2\pi d}{L}} \left(1 - K_2 \sqrt{\frac{HL \coth \frac{2\pi d}{L}}{3yC^2}} \right) \quad (\text{II.5.22})$$

K_1 and K_2 are unknown constants, y is the determining layer thickness for the run-up, and C is a Chézy coefficient. The differential equation from which equation II.5.22 is derived is not indicated by Wagner in the article quoted above.

It appears that in the case of smooth slopes the influence of resistance can be disregarded so that for these instances only the constant K_1 needs to be determined by measurements. Wagner found $K_1 = 0.971$ or 1.131 for the run-up exceeded by 50% or 10%. In the case of a narrow distribution the average run-up cannot differ substantially from the median value so that the value associated with the average run-up will be taken as $0.97 = \text{approx. } 1$. If we also use equation II.5.5, equation II.5.22 becomes

$$z \approx \sqrt{HL_0} \sin \alpha \quad (\text{II.5.23})$$

Apart from the factor $\cos \alpha$, which differs by less than 5% from 1 for $\tan \alpha < 1:3$, this is precisely the formula described by Hunt.

Apart from two K_1 values for the run-up averaged over the flume width, Wagner also indicates two K_1 values for maximum run-up of wave tongues which do not extend over the entire flume width: $K_1 = 1.322$ or $1.5 \cos \alpha$ for heights which are exceeded by 10% or 2% respectively. The 10% run-up of the tongue is 17% greater than the 10% run-up after averaging across the width.

In regard to the run-up of solitary waves on flat slopes, measurements have been made by Hall and Watts (1953), Kaplan (1955) and Kishi and Saeki (1966). The results can be written in the form

$$\frac{z}{d} = K \left(\frac{H}{d} \right)^\xi \quad (\text{II.5.24})$$

in which K and ξ are functions of the gradient of the slope. The measured values are shown in figure II.5.5.

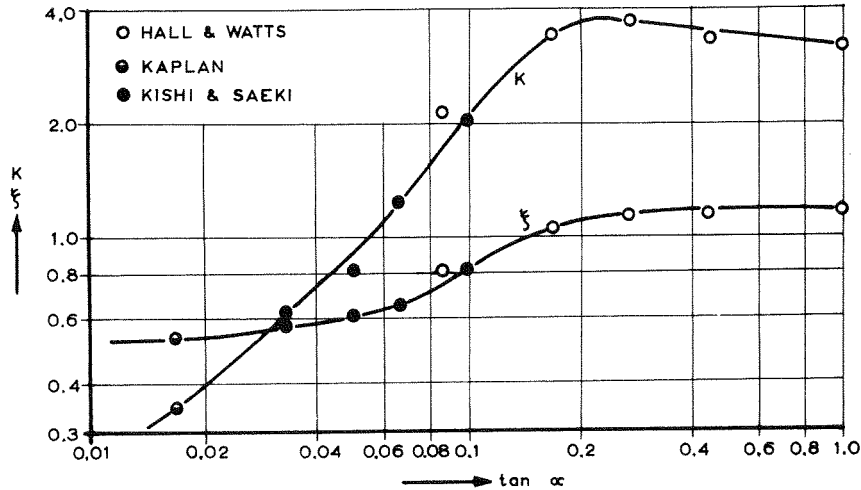

FIG. II.5.5

II.5.3 Plane slope with roughness elements

In this section we shall consider the influence exercised on wave run-up by roughness elements provided in an otherwise plane and impermeable slope. This description excludes all slope coverings which have a substantial intrinsic roughness such as stone revetments. These will be discussed in section II.5.4. The influence of the elements is expressed quantitatively by a factor r , defined as the ratio of run-up on a roughened slope to that on a smooth, impermeable slope under otherwise identical conditions.

Studies of the influence on wave run-up of roughness elements provided on a slope have been primarily carried out in Germany, the Netherlands and Russia and to a lesser extent in the United States. A summary of some of the Dutch results, mostly obtained with irregular waves, has been given by Wassing (1957). More recently Franzius (1965) gave a detailed summary of American, Dutch and Russian data supplemented by the results of an extensive series of experiments which he himself carried out. These results agree very closely with the Dutch ones. The data quoted below were primarily taken from reports M 544-1 (1957) and M 568 (1957) of the Delft Hydraulics Laboratory and from Wassing (1957), Jelgerhuis Swildens (1957) and Franzius (1965).

The experiments described in M 568 and by Jelgerhuis Swildens concern the effect of ribs with a square profile (figure II.5.6).

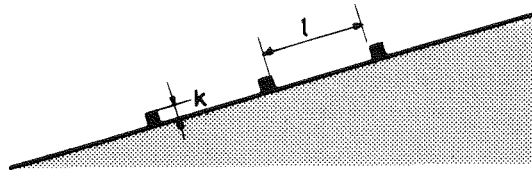

FIG. II. 5. 6

The influence of elements of this form proved to be considerable: the minimum r -values were approx. 0.5.

The effect of the rib is partly due to the storage which is possible behind each rib and partly also to the wake development. The fact that storage has a favourable influence is confirmed by the fact that interrupted ribs give rather more reduction in run-up than continuous ribs. However, the differences are not very large. The opening percentage of course also plays a part. The favourable effect of an opening connected with the creation of a possibility of storage is wholly or partly compensated by the fact that less rib length is available to offer resistance to the flowing water. Jelgerhuis Swildens refers as an example to openings of 0.8 m and a rib length of 4 m. Franzius has studied a number of variants with opening percentages up to 50%, where the form of the elements in the top view varied from continuous ribs through oblong strips to squares. The differences in reduction were small.

The influence of the wake development is evident from the fact that there is an optimum distance between the ribs, which depends on their height. If the distance falls below a certain limit, the contribution of each rib to the total reduction is smaller as a result of the fact that each rib interferes with the wake development of the others. At distances of less than approx. 4 times the height, the favourable influence of the larger number of ribs is even overcome. The optimum distance between square ribs appears to be between 4 and 8 times their height. This is reflected in figure II.5.7, based on data obtained by Jelgerhuis Swildens. A similar phenomenon occurs with a permanent flow along a wall with isolated roughness elements; see Johnson (1944) and Morris (1955).

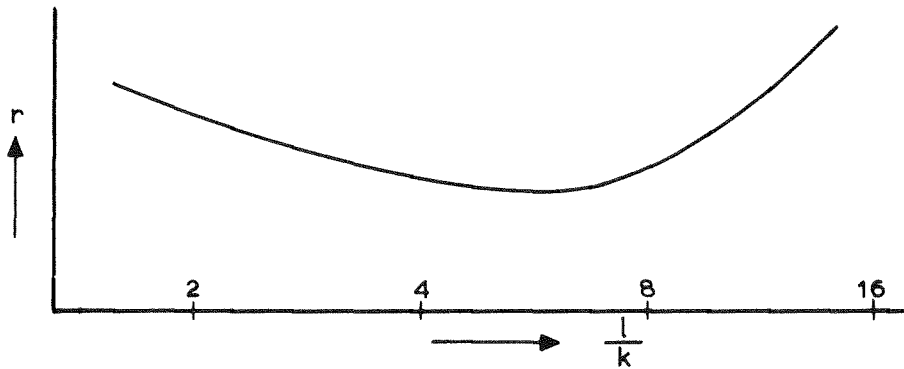

FIG. II.5.7

Comparative experiments carried out by Franzius have shown that the precise shape of the elements has little influence as long as they are sharp-edged on all sides. In the situation studied, it also seemed to make no difference whether the front surface was vertical or perpendicular to the slope.

In addition to the shape of the ribs, their height also plays a part. If the height of the ribs is greater in relation to the thickness of the water tongue, their influence on the run-up increases. It is, however, not necessary for the height to be greater than the thickness of the running-up tongue of water which occurs under circumstances on which the design is based. No quantitative data have been found in the literature on this thickness. An attempt is therefore made to correlate the influence of the roughness height directly with the wave height. Report M 568-1 and the article by Jelgerhuis Swildens (1957) based on this report contain some data which are suitable for a correlation of this kind. In one series of experiments only the ratio k/H (= roughness height/wave height) was varied. All other independent variables are maintained constant including the ratio l/k (=distance/height of ribs). The result is shown in Table II.5.1.

$\frac{k}{H}$	0.03	0.07	0.10	0.13
r	0.7	0.6	0.5	0.5
$\tan \alpha = 1:4$; $\frac{H}{L_0} = 0.03$; $\frac{l}{k} = 2$				

TABLE II.5.1

The data indicate that $k/H \approx 0.10$ is sufficiently large to achieve the maximum reduction. In a second series of experiments l/k was varied from 2 to 8; this had a scarcely noticeable influence on the minimum value of k/H at which maximum reduction occurred (see Table II.5.2).

$\frac{k}{H}$	0.04	0.08	0.12	0.16
r	0.7	0.6	0.6	0.6
$\tan \alpha = 1:4 ; \quad \frac{H}{L_0} = 0.053 ; \quad 2 \leq \frac{L}{k} \leq 8$				

TABLE II.5.2

Franzius also conducted experiments into the influence of the height of ribs and other roughness elements. These results are shown in Fig. II.5.8 in which the mean r values for ribs, cubes and bricks are expressed against k/H with cot α as a parameter. For k/H > approx. 0.1, r is practically constant, which agrees with the results of M 568-1. On the basis of the above data it was concluded that practically no extra reduction in the wave run-up is obtained by giving the ribs a height more than some 10% of the wave height in front of the dike. In the experiments on which this conclusion is based, H/L_0 varied from 0.08 to 0.053 and cot α varied from 2.7 to 5.

The influence of roughness elements on the wave run-up is partly determined by the situation of the roughened area in relation to the mean water level (a in fig. II.5.9) and by its extent (b in fig. II.5.9). Figure II.5.10 shows the influence of a on r for an instance in which the run-up does not reach past the rough zone. This figure is based on Franzius (1965) as is figure II.5.11 in which the influence of b on r is shown for the case a = 0. These results relate to cube-shaped roughness elements where k/H = 0.16, on a slope with a gradient of 1:4.3.

The provision of roughness elements below the water line or above the run-up height has no influence on run-up, as is shown by figures II.5.10 and II.5.11. The latter circumstance is evident; the former is explained by the fact that roughness below the water level does not directly act on the run-up tongue itself but on the wave movement immediately before run-up. In this area, the ratio of water height to roughness height is much greater than in the run-up area so that the water movement encounters less resistance here. This coincides with the results quoted in M 568.

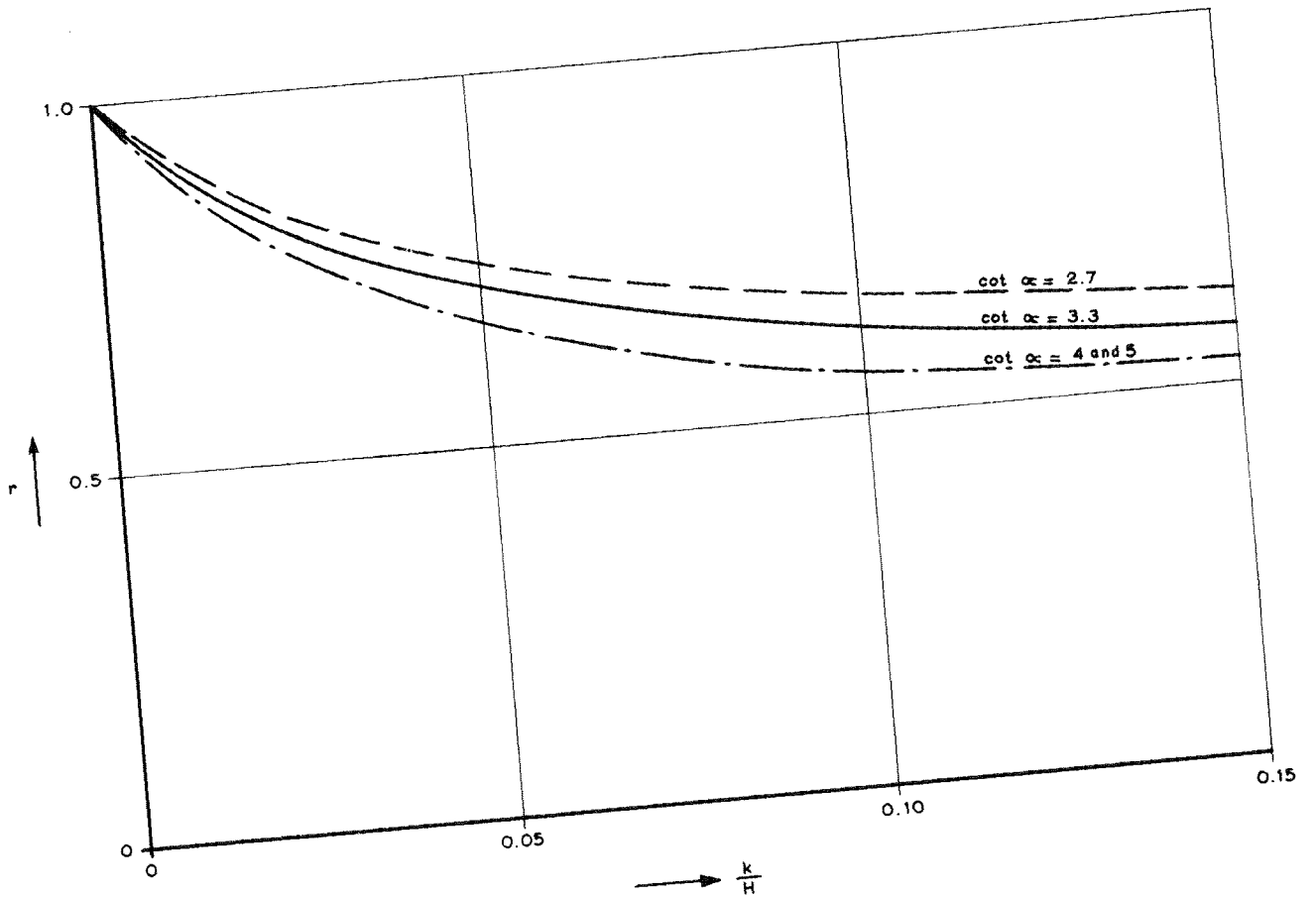
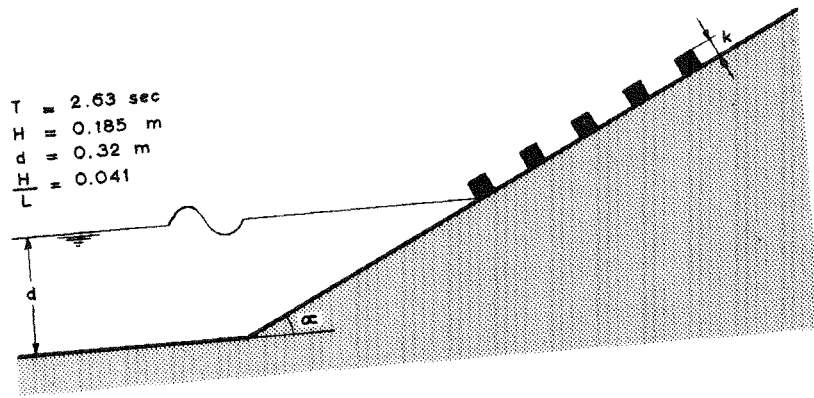

FIG. II.5.8

Figure II.5.11 shows that the reduction in run-up is practically linearly proportional to the width of the rough zone from the water line, provided that the upper limit of the rough zone is situated between the water line and maximum run-up:

$$r = 1 - (1 - r_m) \frac{b}{b_m} \text{ for } \begin{cases} a = 0 \\ b \leq b_m \end{cases}$$

$$r = r_m \text{ for } \begin{cases} a = 0 \\ b \geq b_m \end{cases} \quad (\text{II.5.25})$$

In order to achieve the maximum possible reduction in run-up, the roughness elements must therefore be provided at least between the design water level and the point at which the run-up of the design wave is expected. Often this is the crest of the dike.

The effect of the roughness elements, expressed by the factor r , is not only dependent on the shape, orientation and relative size etc. of the roughness itself but also to some extent on the slope gradient and wave steepness. However there is no agreement in published literature on the influence of these variables.

American experiments (Savage, 1958, 1959) indicate that r diminishes with decreasing wave steepness and diminishing slope gradient.

In the Dutch experiments the influence of H/L_0 and α on r has not been systematically studied. Report M 568 only refers to slope gradients of 1:4 so that it is impossible to draw conclusions from this relating to the influence of α ; a comparison of the results of experiments with different wave steepnesses shows that a higher H/L_0 is accompanied by a greater r value, which coincides with Savage's observations.

Experiments conducted by Franzius (1965) indicate that r may either increase or decrease with H/L and α , as is apparent from figure II.5.12:

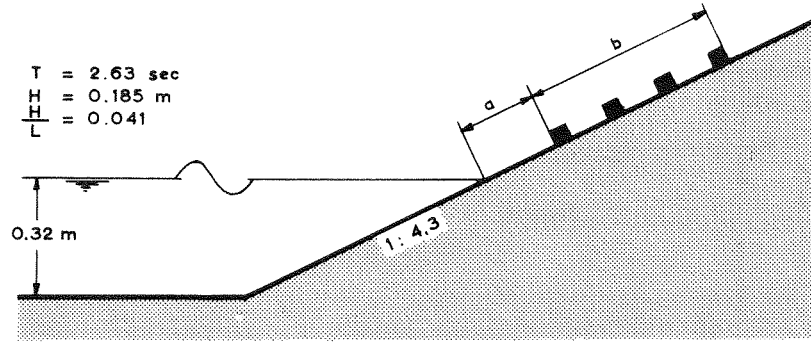

FIG. II. 5.9

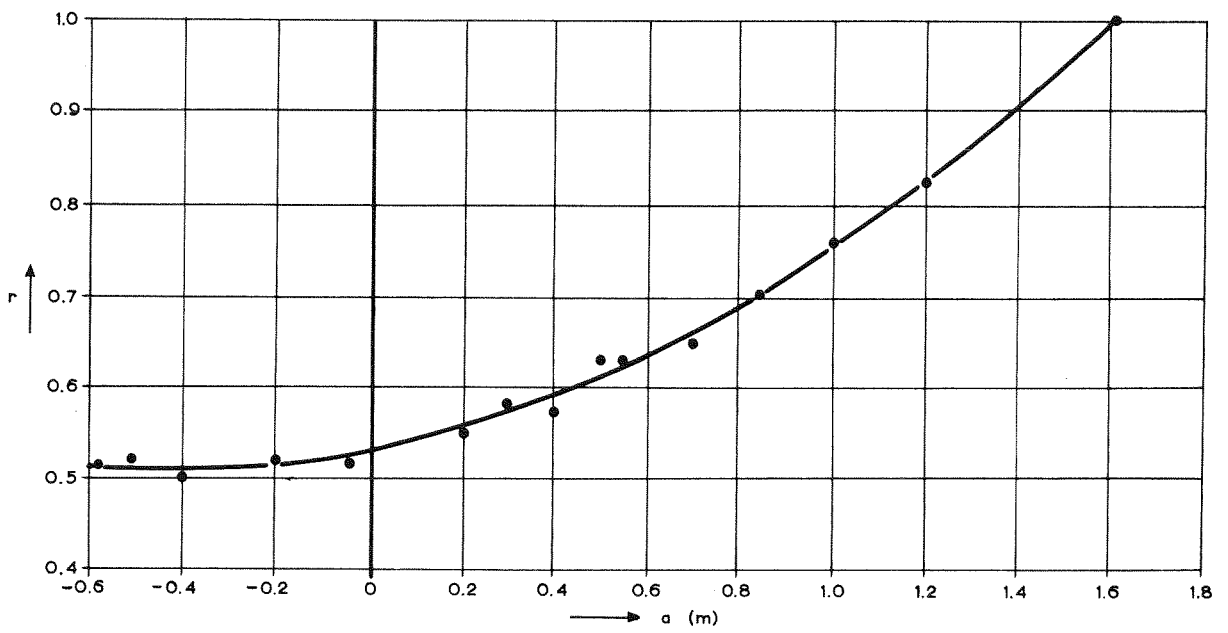

FIG. II. 5.10

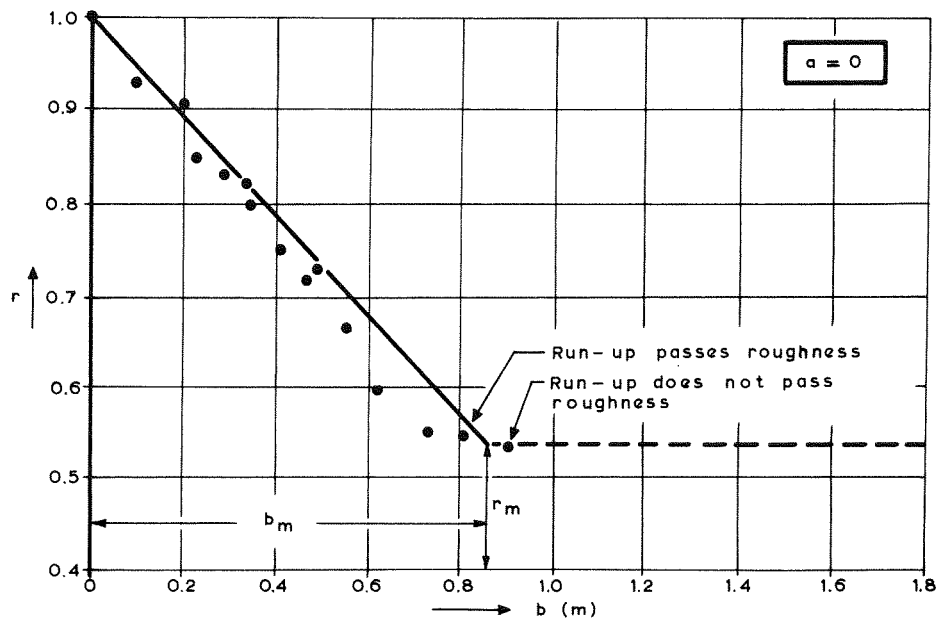

FIG. II. 5.11

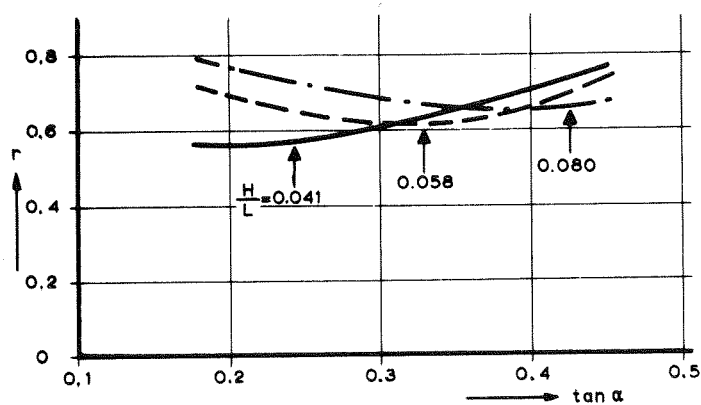

FIG. II. 5.12

Type of roughness :
cubes

$$\frac{k}{H} = 0.11 \text{ to } 0.13$$

For each H/L ratio there is an α value at which the roughness is most effective; for slopes with $\tan \alpha$ approx. 1:3, the influence of the roughness diminishes as the waves are steeper. For a gradient of 1:5 for example, $r = 0.56$ with $H/L = 0.041$ and $r = 0.76$ with $H/L = 0.080$; the roughness for which these values apply consisted of cubes. For other kinds of roughness element, the value of r may of course differ. It is, however, true that the type of roughness which gives the greatest reduction is not dependent on α or H/L (Franzius).

Wagner (1969) gives the following expression for r :

$$r = 1 - K_f \left(\frac{k}{H} \sqrt{\frac{H}{L}} \right)^{0.4} (\sin \alpha)^{-\frac{1}{3}} \quad (\text{II.5.26})$$

The influence of the roughness is expressed in the shape factor K_f and in the height k . According to equation II.5.26, r reduces with diminishing α or increasing H/L, in accordance with or in contrast to Savage's results.

On the basis of the foregoing it may be concluded that the influence of the wave steepness and slope gradient on r is not negligible and that the literature considered is not consistent in regard to the size and sign of this influence. As a result additional tests will generally be necessary for a design in which the roughness plays an essential part in determining the crest height.

It should be noted that there are certain drawbacks in roughened slopes. If a storm surge occurs which exceeds the design water level, more overtopping will occur with a rough slope than with a smooth slope. This has been pointed out by Schijf (1957) with reference to the article

by Jelgerhuis Swildens (1957) referred to earlier. In his rejoinder (1957) Jelgerhuis Swildens points out that this is not the case because the reduction of the dike height should only equal the reduction in run-up height so that the safety factor will remain the same. This question is interesting in assessing roughness and some attention will therefore be given to it; the arguments will be quantified as far as possible.

Let us assume that the design level is P and the design run-up for the smooth or rough slope z_s and z_r as indicated in figure II.5.13 (a or b).

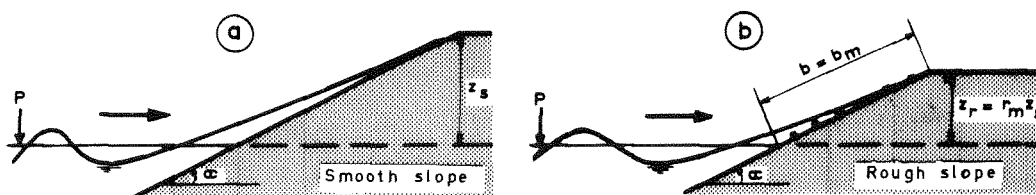

FIG. II.5.13

The rough zone extends from the design level to the crest of the dike which is assumed to lie at the level of the design run-up. In this case

$$b = b_m = \frac{z_r}{\sin \alpha} \quad (\text{II.5.27})$$

and

$$z_r = r_m z_s \quad (\text{II.5.28})$$

If, under otherwise identical conditions, a water level occurs with a height x above the design level, the run-up will overtop the crest. In this case, the frictitious run-up height O is defined as the run-up height above the crest of the dike which would occur if the slope extended beyond the crest free from roughness.

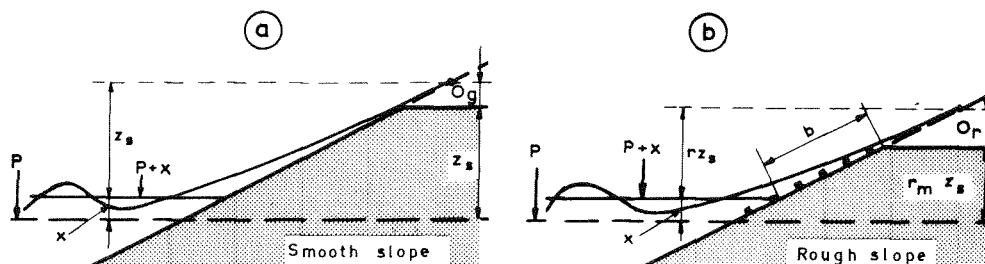

FIG. II.5.14

For the rough slope, we now have (see figure II.5.14b):

$$b = \frac{r_m z_s - x}{\sin \alpha} \quad (\text{II.5.29})$$

and

$$b_m = \frac{r_m z_s}{\sin \alpha} \quad (\text{II.5.30})$$

Substitution of the above in equation II.5.26 gives

$$r = r_m + \frac{x}{z_s} \left(\frac{1}{r_m} - 1 \right) \quad (\text{II.5.31})$$

Figure II.5.14b shows that

$$O_r = r z_s + x - r_m z_s$$

or, using equation II.5.31:

$$O_r = \frac{x}{r_m} \quad (\text{II.5.32})$$

For the smooth slope, $r = r_m = 1$ so that

$$O_s = x \quad (\text{II.5.33})$$

which also follows directly from figure II.5.14a. Finally, elimination of x gives

$$O_r = \frac{1}{r_m} O_s \quad (\text{II.5.34})$$

For the roughness values referred to above, r_m may amount to approx. 0.5 so that the fictitious run-up height above the crest of a rough slope will then be approximately twice the equivalent value for a smooth slope. This implies that the overtopping above a rough slope will be greater than in the case of a dike with a smooth slope if the design water level is exceeded. This does not of course apply only to slopes with ribs etc. but also to rough and permeable slopes and to slopes with a berm at the design water level. These slopes will be discussed in sections II.5.4. and II.5.5.

Comparison of

$$z_r = r_m z_s \quad (\text{II.5.28})$$

and

$$O_r = \frac{1}{r_m} O_s \quad (\text{II.5.34})$$

shows that the influence of roughness on the run-up height below the crest is exactly the opposite of the influence on the fictitious

run-up height above the crest.

II.5.4 Rough and permeable slope

In the previous section the influence of roughness elements on an otherwise smooth slope was discussed; we shall now consider the roughness inherent in certain facings, particularly stone facings. In addition to their roughness, revetments of this kind generally also have a certain permeability so that some of the water which runs up may be retained in the slope. This may considerably reduce run-up. Because the effects cannot be isolated, the influence of roughness and permeability must be considered jointly and not in isolation. The joint effect is expressed in the factor r .

Drogosz-Wawrzyniak (1965) gives a considerable number of values of the coefficient r for rough permeable slopes. The data in this article are of Russian origin, due in particular to Shankin, Pishkin and Sidorowa. Table II.5.3 indicates some values for r given by Shankin:

	r
SMOOTH, IMPERMEABLE REVETMENT	1
CONCRETE SLABS	0.9
SET STONE	0.75 - 0.8
ROUND STONES	0.6 - 0.65
RUBBLE	0.5 - 0.55

TABLE II.5.3

Pishkin has derived the following formula from laboratory experiments, where $0.05 \leq H/L \leq 0.10$:

$$z_{\max} = \frac{0.565}{\sqrt{n}} H \tan \alpha \quad (\text{II.5.35})$$

Here z_{\max} is the maximum run-up and n the roughness coefficient indicated by Ganguillet and Kutter or Manning. In Pishkin's experiments n varied from 0.010 to 0.035. This n has the dimension $[L^{\frac{1}{6}}]$, and equation II.5.35 is therefore not dimensionally homogeneous. In place of an absolute roughness factor represented by n , it would be

preferable to introduce a relative roughness, e.g. $n/H^{1/6}$. The necessary data to change equation II.5.35 in this way are lacking, however.

A number of r values based on equation II.5.35 are given in Table II.5.4. The n values quoted in the table are taken from Henderson(1966). The r values in the last two columns have been calculated for the assumption that $n = 0.010$ or 0.011 for a smooth impermeable revetment. Although the descriptions of the materials in tables II.5.3 and II.5.4 differ somewhat, it may be stated that there is a good measure of concordance between the values given by Pishkin and Shankin.

MATERIAL	n	$r = \sqrt{\frac{0.010}{n}}$	$r = \sqrt{\frac{0.011}{n}}$
GLAS, PLASTIC	0.010	1	1.05
LEVELLED PLASTER, PLANED WOOD	0.011	0.95	1
ROUGH CONCRETE	0.014	0.85	0.89
STONE SET IN CEMENT	0.017	0.77	0.81
RUBBLE: $n=0.031 D_{75}$, D_{75} in ft			
$D_{75} = 0.10$ m	0.026	0.62	0.65
$D_{75} = 0.60$ m	0.035	0.54	0.56

TABLE II. 5. 4

Sidorowa (1960) indicates the following dimensionless formula for r :

$$r = e^{-2\frac{D}{H}} \quad (\text{II.5.36})$$

D is defined without further clarification as the absolute roughness of the slope. For rubble slopes at the limit of stability the ratio D/H is often between 0.25 and 0.40. The corresponding r values according to Sidorowa (figure II.5.15) correspond reasonably well with those quoted by Shankin, table II.5.3. Care is necessary in applying equation II.5.36 for other D/H values because it is not known which

D/H interval was represented in the experiments from which equation II.5.36 was derived. It should also be noted that in Franzius (1965) Sidorowa's formula is incorrectly presented, i.e. as $r = e^{-4 D/H}$.

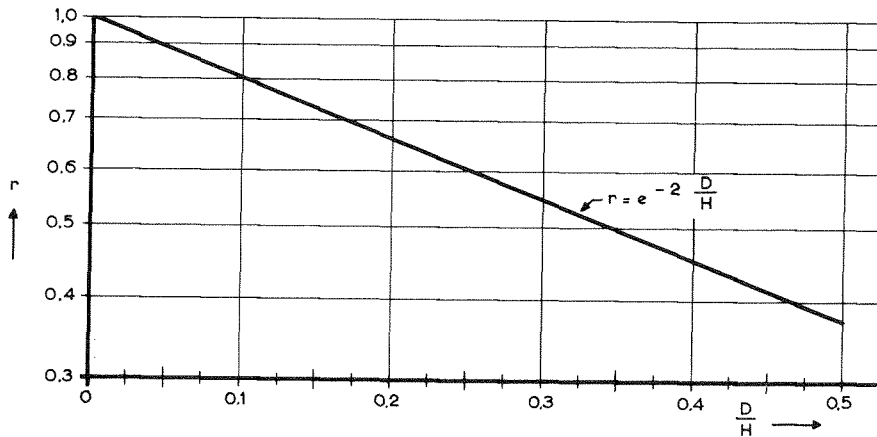

FIG. II.5.15

The above considerations show that a dumped stone covering with $D/H \approx 0.3$ reduces run-up by practically the same amount as optimally placed ribs with $k/H \approx 0.1$, despite the fact that the ribs are smaller and the slope impermeable. An explanation of this may be found in the fact that the entire height of the protruding ribs acts as roughness. On the other hand with a dumped or set layer, the stones are laterally supported against each other and only part of their height acts as roughness (a set basalt cover is an extreme example of this).

For impermeable slope revetments with natural roughness Wagner (1969) gives a variant to his equation II.5.26:

$$r = 1 - 0.73 \left(\frac{k_s}{H} \sqrt{\frac{H}{L}} \right)^{0.4} (\sin \alpha)^{-\frac{1}{3}} \quad (\text{II.5.37})$$

in which k_s is the roughness factor according to Nikuradse. In the experiments on which equation II.5.37 is based, $k_s < 0.033 \sqrt{HL}$ and $\cot \alpha < 5$.

The Delft Hydraulics Laboratory has made a number of measurements on a rubble slope with a gradient of 1:3. The measured r values were between 0.5 and 0.6.

Figure II.5.16 gives a number of results for wave run-up measurements carried out in the Hydraulics Research Station in Wallingford on a rubble slope with a gradient of 1:2 (Hydraulics Research, 1965). For $H/L_0 > \text{approx. } 0.03$ the result may be expressed by

$$\frac{z}{H} = \frac{0.27}{\sqrt{\frac{H}{L_0}}} \quad (\text{II.5.38})$$

If the run-up for the corresponding smooth slope is determined with equation II.5.8, it follows that

$$r = \frac{0.27\sqrt{HL_0}}{\sqrt{HL_0} \tan \alpha} = 0.54 \quad (\text{II.5.39})$$

The C.E.R.C. handbook (1966) indicates as a guideline $r = 0.5$ for a slope revetment consisting of two or more layers of rubble. For a single layer of stone, $r = 0.8$ is recommended. These recommendations are based on experiments by Hudson (1959). The size of the

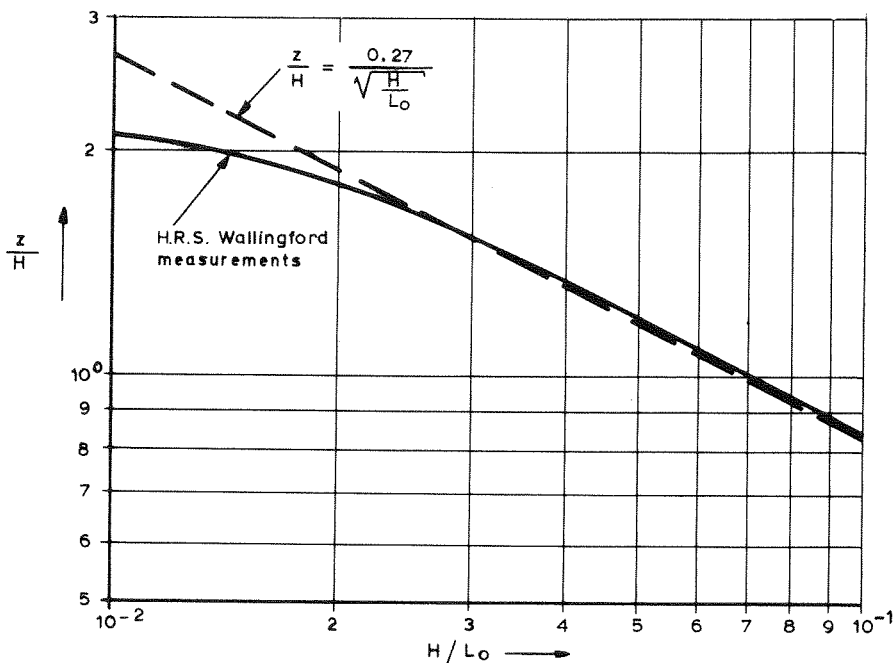

FIG. II. 5.16

stones was determined by stability requirements so that with given wave characteristics the size varied as a function of the slope gradient and of the placement, shape and specific weight of the stones. These experiments and those conducted by Savage (1958) show that r reduces with diminishing wave steepness and slope gradient. This influence is not included in the final recommendations for design because the dispersion of the results was too great.

Basalt coverings differ from rubble surfaces through the form and placement of the stones, so that the resulting roughness and permeability is much lower. According to Wassing (1957) the corres-

ponding r value is 0.85 to 0.90. This value also applies to turf (Franzius, 1965).

For tetrapods, Starosolszky (1961) quotes an r value of 0.5. A summary of the above values is given in table II.5.5.

SOURCE	COVERING	r
Shankin	SMOOTH, IMPERMEABLE	1
	CONCRETE BLOCKS	0.9
H.L.Delft	BASALT COVERING STONE BLOCKS	} 0.85 to 0.9
Franzius		
C.E.R.C.	1 LAYER OF RUBBLE	0.8
Shankin	SET STONE	0.75 to 0.8
Shankin	ROUND STONES	0.6 to 0.65
H.L.Delft	RUBBLE	0.5 to 0.6
H.R.S.Wallingford	RUBBLE	0.5 to 0.55
Shankin	BROKEN RUBBLE	0.5 to 0.55
C.E.R.C.	2 OR MORE LAYERS OF RUBBLE	0.5
Starosolszky	TETRAPODS	0.5

TABLE II.5.5

It will be seen that the values found by the various authors match fairly well.

II.5.5 Non-plane, smooth slope

The wave run-up is not only influenced by the roughness or permeability of a slope but also by the shape of the latter. The shape of the slope must therefore be considered as an independent variable. The influence of the shape cannot, however, be expressed easily in quantitative terms by a multiplication factor as may be used for the rough, plane slope, since in the case of non-plane slopes it is generally not clear what corresponding plane slopes

should serve as a reference. This is particularly true for concave or convex slopes. An exception is provided by slopes with a berm, provided that the gradients below and above the berm are identical. The corresponding plane slope is then defined as the limiting case in which the berm width becomes zero.

A consequence of the above problem is that the data available on run-up on non-plane slopes are usually only valid incidentally and no generalization is possible in the manner referred to above. A special method of generalization is proposed by Saville (1958) for regular waves on slopes of arbitrary form. This method will be discussed first. A number of results will then be presented for slopes with and without a berm.

Saville's equivalent gradient method

According to Saville, run-up on a non-plane slope corresponds to run-up on an equivalent plane slope intercepting the non-plane slope at the position of the breaking point of the wave and the maximum wave run-up, as indicated in figure II.5.17.

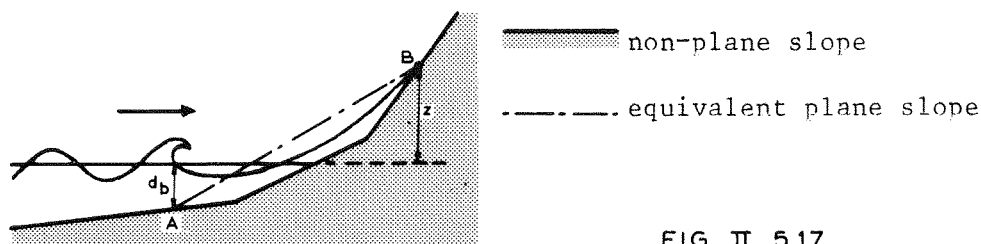

FIG. II.5.17

The run-up z is determined iteratively by using the above definition of the equivalent plane slope and known data for run-up on a plane slope. The procedure proposed by Saville is as follows:

1. Given: g , T , H , d , slope form, run-up on a plane slope as a function of slope gradient and g , T , H and d .
2. Determine the breaking depth d_b from

$$\frac{d_b}{H_0} = 0.39 \left(\frac{H_0}{L_0} \right)^{-\frac{1}{3}} \quad (\text{II.5.40})$$

3. Determine the point A at which the depth is equal to d_b .
4. Estimate the run-up.
5. Determine the point B reached by the estimated run-up.
6. Determine the gradient of the line AB.
7. Determine the run-up of the given wave on a plane slope with the gradient referred to in 6 above.
8. Compare the run-up obtained in this way with the estimated value. If the difference is too great, repeat the procedure from 4, the new estimate of run-up being identical to the run-up calculated in 7 above.

It is also possible to determine the equivalent plane slope graphically. In this case the corresponding run-up is calculated according to 5, 6 and 7 above, for a number of estimated run-up values. The estimated run-up values are plotted against the calculated values in a graph. The point at which they are identical must then be determined by interpolation.

Although the validity of equation II.5.40 is very doubtful, especially when the waves and slopes are relatively steep, this need not influence the validity of Saville's method. After all, the method as such is at least as arbitrary as the use of equation II.5.40 as a breaking criterion. Saville's method consists of a number of empirical rules which together may give a usable result. The validity of the method is determined in the final analysis by a test against measurement of run-up and not by the fact as to whether each of the elements on which the method is based is "permissible".

Saville presents a number of applications of his method on slopes with a shape indicated in figure II.5.18 and on slopes with a berm. The results appear to coincide well with measurements taken in Vicksburg, except in the case of slopes with a broad berm ($B = 150$ ft, $L = 160$ to 200 ft, prototype).

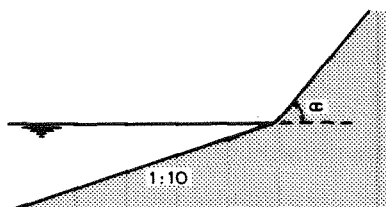

$$\cot \alpha = \frac{1}{2}, 1\frac{1}{2}, 3, 6$$

FIG. II. 5.18

With increasing berm width, the run-up calculated according to Saville's method decreases more rapidly than the measured run-up. This is also apparent from measurements by Herbich, Sorensen and Willenbrock (1963) who conducted additional tests in order to determine the maximum berm width for which Saville's method is reliable. They found that the boundary lies at a berm width (B) of approx. $1/7 L$. For greater berm width, the run-up still diminishes but less rapidly than suggested by Saville's method.

Herbich et al also found that Saville's method was not always applicable. Let us assume that on an initially plane slope, a berm is provided at approximately half way between the water level and the maximum run-up. With increasing berm width both the gradient of the equivalent slope and the run-up diminish. With a sufficiently large berm width the theoretical run-up becomes so small that the berm is not reached. The gradient of the equivalent slope to be used in the subsequent iteration then increases suddenly to the gradient of the original slope. Clearly the iterative method is not satisfactory in such cases to determine the equivalent gradient. This can also be demonstrated analytically.

The slopes used by Saville (figure II.5.18) are not representative of non-plane slopes. The method was not tested by him against measurements on convex slopes or slopes with a continuously varying gradient. Model measurements by Hensen (1955) are suitable for a test of this kind. The results of comparison of these measurements with the run-up height determined by Saville's method are given in figure II.5.19. The concordance is good for the plane and convex slopes. This is, however, not the case for the concave slope where the calculation gives values which are too low.

Kato (1959) carried out tests relating to wave run-up on a number of walls and dikes of Japanese origin and he compared his measurements with the results obtained by using Saville's method. Kato found that "the results were as expected". He also indicated an extension of Saville's method for instances in which the waves do not break on the slope. The seaward limit of the equivalent plane slope then lies at a point which is one half of a wave length removed from the dike instead of at the breaking point of the wave. Kato does not specify which wave length is referred to (at what depth) or from which point on the dike a distance of one half of the wave length

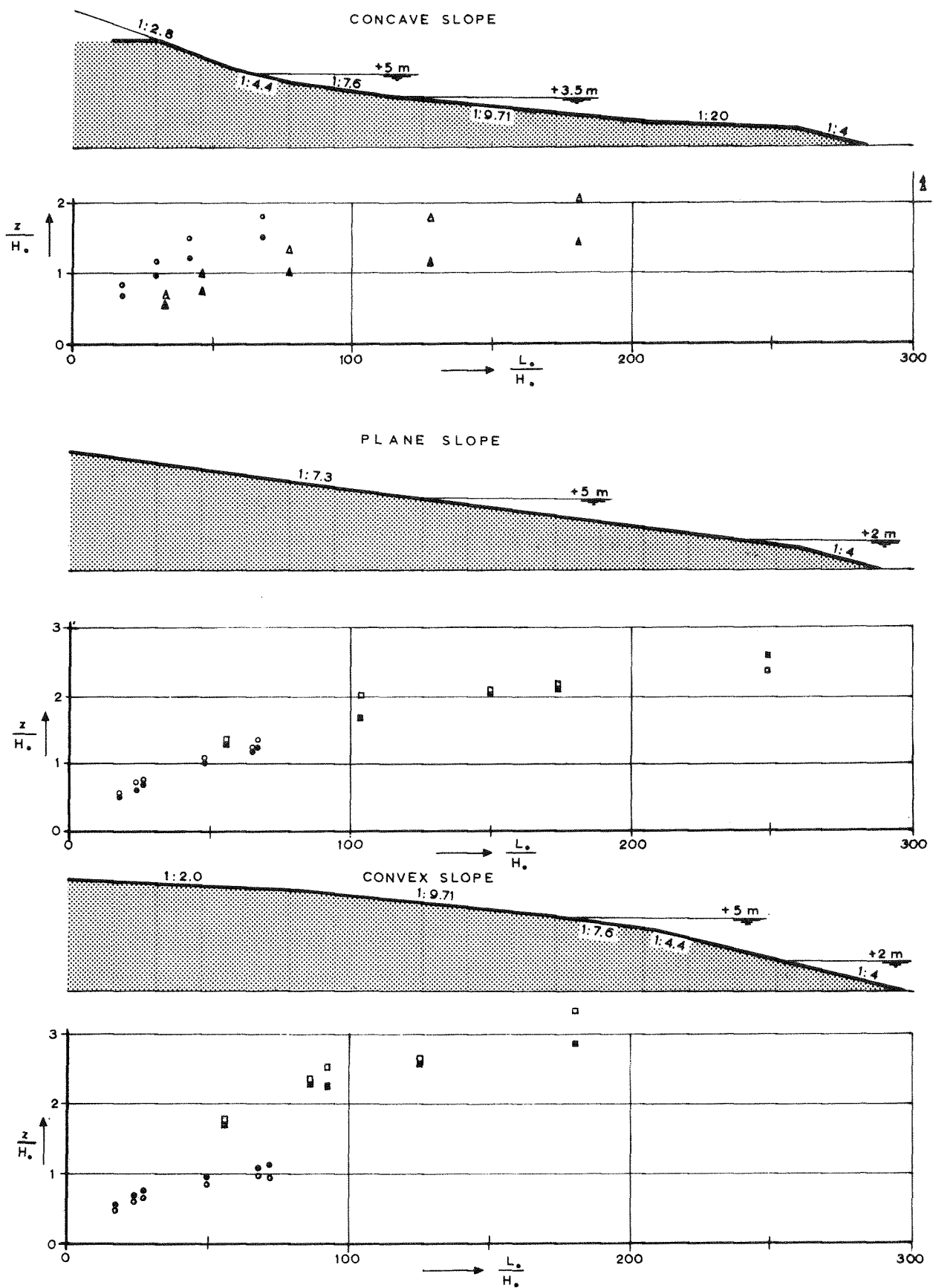

	Waterlevel above datum		
	+2 m	+3.5 m	+5 m
Model results according to Hensen	□	△	○
Calculation according to Saville	■	▲	●

must be measured.

Savage (1962) indicates a graphic method of checking whether the run-up reaches the crest of the dike for a given water level, dike profile and wave steepness in deep water. For this purpose he uses Saville's method.

In conclusion, it may be stated that the equivalent gradient method outlined by Saville to determine the run-up of regular waves on non-plane slopes has its merits although there is some uncertainty as to the limits of its validity. In view of the strongly empirical nature of the method, considerable caution is necessary in applying it to slope shapes which differ clearly from the shapes for which the method has been found to be valid. This is all the more true since the real run-up tends to be underestimated rather than overestimated.

Slopes without berm

The model study by Hensen (1955) referred to earlier was intended to examine the influence of the dike shape on run-up. A concave slope, a plane slope and two convex slopes were compared at different water levels and wave periods. The results show that the run-up on the convex slopes was lower than the run-up on the plane or concave slope at a high water level, and higher at a low water level. Hensen concludes from this that the slope gradient above the mean water level is largely decisive in determining wave run-up.

The slopes examined by Hensen had no berms. His conclusion that the slope gradient above the water line is decisive for run-up cannot therefore be taken to refer to slopes with a berm just below or above the water level. The question also arises as to what the slope gradient is above the water level in the case of a slope with variable gradient. In Hensen's experiments, the gradient did not vary continuously but in a discrete number of steps. Hensen's figures show that the gradient is chosen for that part of the slope on which the greatest proportion of run-up took place. If the gradient varies continuously, it is even more difficult to give a clear a priori definition of the gradient above the water line, especially if the local gradient changes considerably over that part of the slope where the run-up is anticipated. This will be the case if the run-up

length along the slope is not small in relation to the average radius of curvature of the slope.

For a slope with a sharp bend, Drogosz-Wawrzyniak (1965) gives the following formula, derived by Pishkin:

$$\tan \alpha_{eq} = \tan \alpha_1 + 2 \frac{d_B}{L} (\tan \alpha_2 - \tan \alpha_1) \quad (\text{II.5.41})$$

α_{eq} is the gradient angle of an equivalent plane slope on which the same run-up takes place as on the slope with the sharp change in angle. The significance of the other symbols is indicated in figure II.5.20. It is not known what the limits of validity are of equation II.5.41 but an inspection shows directly that there must be some limitations.

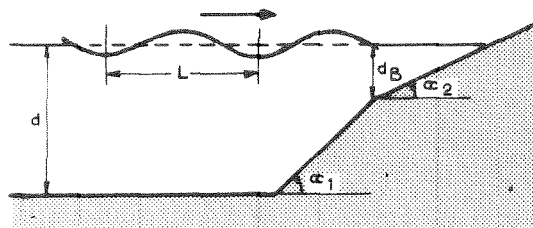

FIG. II. 5. 20

1. If d_B approaches d , or if $d_B/L > \frac{1}{2}$ approximately, the run-up must become independent of α_1 .
This does not follow from equation II.5.41.
2. If $d_B = 0$, it follows from equation II.5.41 that $\tan \alpha_{eq} = \tan \alpha_1$ regardless of α_2 . This is not correct.

The special examples show quite clearly that the range of validity of equation II.5.41 must be properly defined. As long as this range is unknown, use of Pishkin's formula is not advisable.

Slope with berm

Various experiments have shown that the effect of a berm with a constant width is maximum when the berm is situated approximately at the average water level. It has furthermore been found that run-up diminishes with increasing berm width although the reduction rapidly falls off once a certain minimum width is passed. Quantitative data on this aspect are, however, incomplete and there is wide scatter.

Before presenting these data with a view to their interpretation a dimensional analysis of the problem will be carried out.

Let us consider the instance of perpendicular incidence, a slope adjoining a horizontal foreshore, a horizontal berm at a depth d_B below the average water level, and identical gradients for the lower and upper slope sections (figure II.5.21). The influence

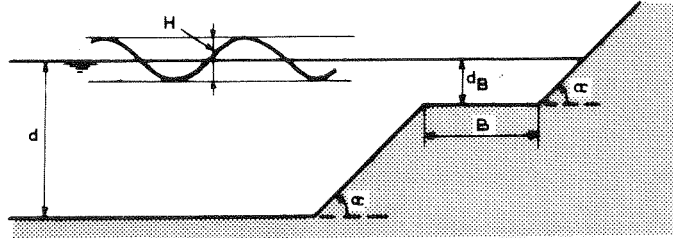

FIG. II.5.21

of viscosity and surface tension will be disregarded. We then have the following expressions for z_B , the run-up in the presence of a berm:

$$z_B = f(H, T, g, d, \alpha, B, d_B) \quad (\text{II.5.42})$$

or

$$\frac{z_B}{H} = f\left(\frac{H}{gT^2}, \frac{d}{gT^2}, \frac{B}{gT^2}, \frac{d_B}{gT^2}, \alpha\right) \quad (\text{II.5.43})$$

If $B = 0$, it follows that

$$r = f\left(\frac{H}{gT^2}, \frac{d}{gT^2}, \alpha\right) \quad (\text{II.5.44})$$

so that

$$\frac{z_B}{z} \equiv r = f\left(\frac{H}{gT^2}, \frac{d}{gT^2}, \frac{B}{gT^2}, \frac{d_B}{gT^2}, \alpha\right) \quad (\text{II.5.45})$$

or

$$r = f\left(\frac{B}{gT^2}, \frac{B}{H}, \frac{B}{d}, \frac{B}{d_B}, \alpha\right) \quad (\text{II.5.46})$$

It follows that the value of r is dependent on a number of parameters. As will be seen from the data presented below, r is, however, generally considered dependent on one parameter only, representing a relative

berm width. The wide scatter which occurs in the results shows clearly that the influence of the other parameters is not negligible. This is also apparent from the results of the tests already referred to by Herbich, Sorensen and Willenbrock (1963) shown in figure II.5.22. In the tests in question, the berm was situated 3.5 cm below the mean water level with a wave height between 2.7 and 10 cm. The dispersion in the measured r values is approximately 40% of the average value at a fixed B/L . This dispersion is too great to be attributed to inaccuracies. It is therefore not sufficient to use B/L only as an independent parameter.

To gain a clearer picture of this phenomenon, the findings of Herbich et al were re-examined on the basis of equation II.5.46. This showed that r was better correlated to the product of the terms B/gT^2 and B/H_0 than to each of the two terms separately. The result of this calculation supplemented by some data from the Delft Hydraulics Laboratory (M 544), is shown in figure II.5.23. The ratio between the water depth above the berm d_B and the breaking depth of the oncoming wave d_b has been included in the graph as parameter. The breaking depth d_b has been calculated with the aid of equation II.5.40. For constant values of $B/\sqrt{H_0 L_0}$, high r values (low reduction) seem to correspond to high values of the factor d_B/d_b (relatively deep berm location). In addition it is striking that r is practically constant for constant values of d_B/d_b if $B/\sqrt{H_0 L_0} > 1$.

Figure II.5.24 shows the results of the experiments conducted by Herbich et al in which the berm was located 2.5 cm above the mean water level. It is apparent that the reduction in wave run-up does not decrease sharply with increasing relative berm width. Herbich et al ascribed this to the fact that a water cushion is formed on the high-lying berm and held in reciprocating movement by the oncoming waves.

In almost all the tests r does not reduce monotonically with increasing relative berm width. In a number of instances r shows a minimum at $B/\sqrt{H_0 L_0} \approx 0.25$.

Drogosz-Wawrzyniak (1965) presents two Russian formulae by Shankin and Pishkin respectively for determining the effect of a horizontal berm on run-up. According to Shankin

$$r = e^{-0.32\sqrt{\frac{B}{H}} \left(1 - \sqrt{\frac{d_B}{d}}\right)} \quad (\text{II.5.47})$$

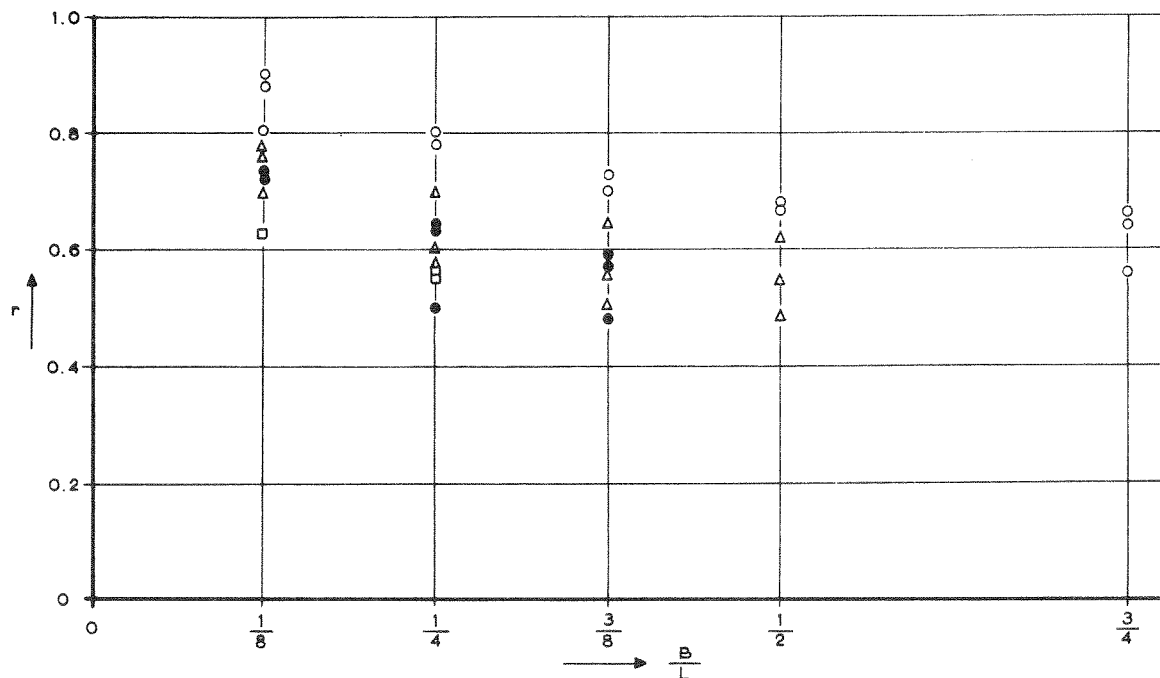

○ L = 27.7 inch }
 △ L = 57.8 " } Herbich et al, $\tan \alpha = \frac{1}{4}$; berm 1.4 inch
 ● L = 87.7 " } below waterlevel; $d = \frac{1}{4}$ ft.
 □ L = 118.1 " }

FIG. II.5.22

- $\frac{d_B}{d_b}$
 Δ — 1.14
 \blacktriangle — 0.80
 $+$ — 0.64
 \circ — 0.30 - 0.50
 \blacksquare — 0
- } Measurements by Herbich et al series 1 to 12
 → Measurements: Delft Hydraulics Laboratory

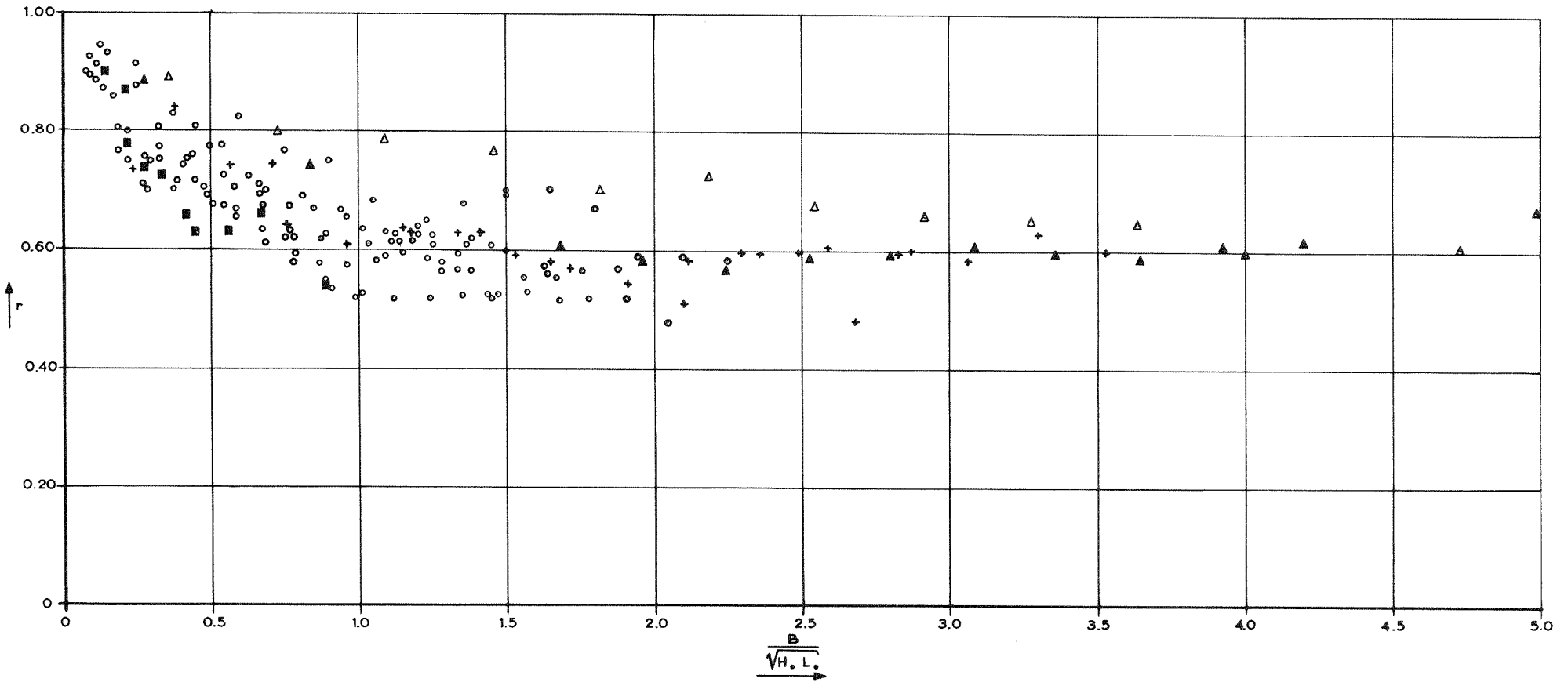
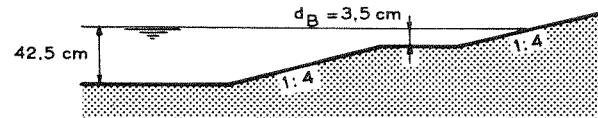

FIG. II . 5 . 23

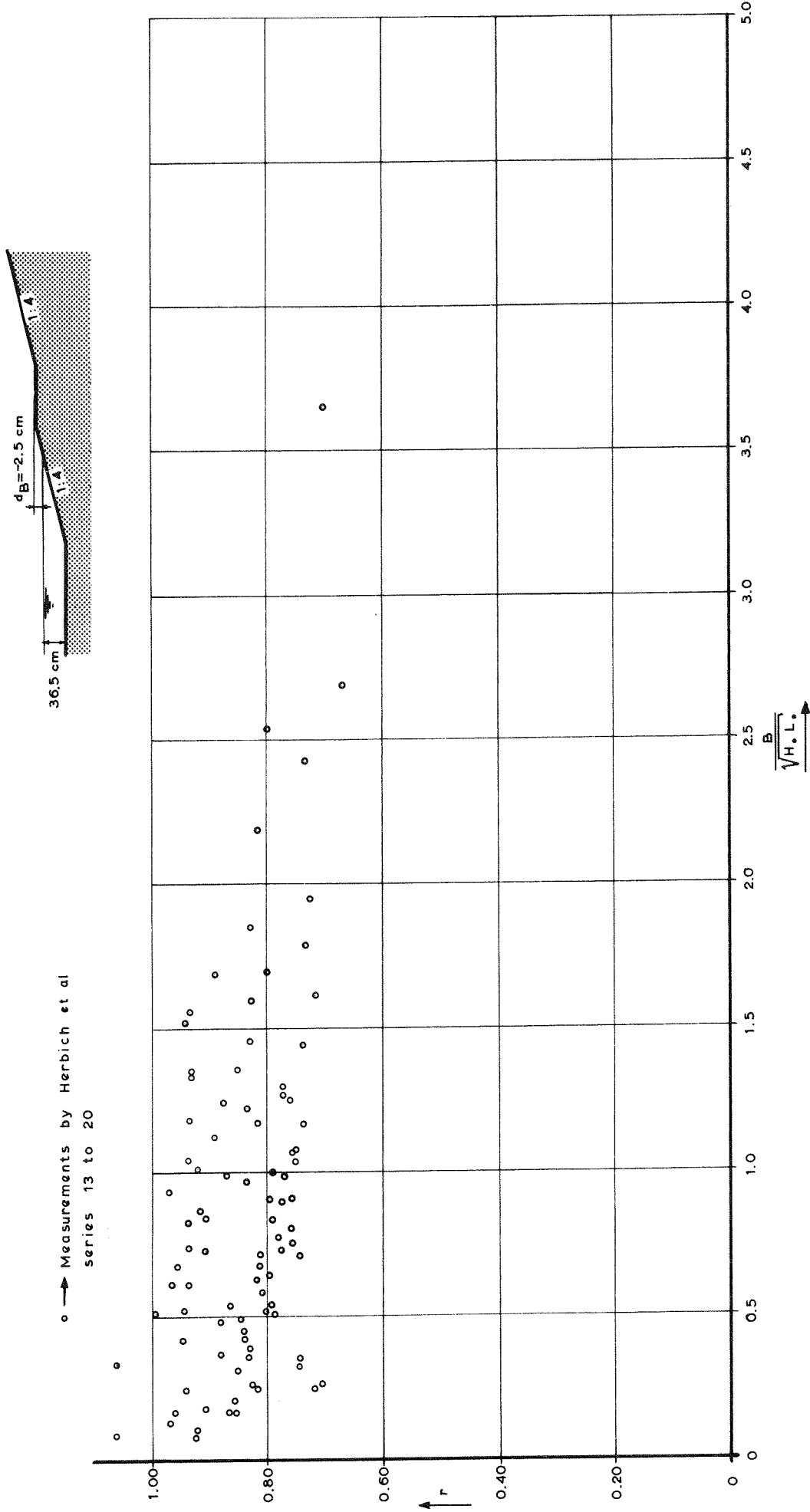

FIG. II.5.24

Pishkin gives a formula for unequal gradients of the lower and upper sections, α_1 and α_2 respectively:

$$\tan \alpha_{eq} = (1 - 0.2\sqrt{\frac{B}{H}}) \tan \alpha_1 + 2 \frac{d_B}{L} \left\{ \tan \alpha_2 - (1 - 0.2) \frac{B}{H} \tan \alpha_1 \right\} \quad (\text{II.5.48})$$

The version of Pishkin's formula presented by Drogosz-Wawrzyniak clearly contains an error in the factor $(1 - 0.2)B/H$ of the second term in the righthand expression. This factor must become 1 when $B = 0$, see equation II.5.41. In Shankin and Pishkin's experiments the wave steepness was varied between approx. 0.04 and 0.10.

When $d_B = 0$, equation II.5.47 becomes

$$r = e^{-0.32\sqrt{\frac{B}{H}}} \quad (\text{II.5.49})$$

while it may be concluded from equation II.5.48, if in addition we take $\alpha_1 = \alpha_2 = \alpha$, that

$$r = 1 - 0.2\sqrt{\frac{B}{H}} \quad (\text{II.5.50})$$

According to both formulae the factor r depends in this instance solely on B/H . The above remarks have shown that this cannot be exact. Nevertheless it is significant that in these formulae the berm width is expressed in wave height rather than in wave length. Since the wave steepness was varied in the study, it may be concluded that the wave height is also an independent variable for r .

A graphic presentation of equation II.5.49 and II.5.50 is given in figure II.5.25. For $B/H < 10$, Pishkin's formula appears to give rather higher r values than Shankin's formula.

To sum up it may be stated that present knowledge of the influence of a berm on wave run-up is slight. Accurate quantitative data are lacking and it is insufficiently clear what influence the parameters B/gT^2 , B/H , B/d_B , B/d and α have on r . The indicated relationships cannot therefore be assumed to have any general validity.

II.5.6 Oblique incidence

Data on run-up of regular waves with oblique incidence are very scarce. Data of this kind were found in two sources only.

Drogosz-Wawrzyniak (1965) reports that Djounkowski expresses the influence of the direction of incidence on the run-up of breaking

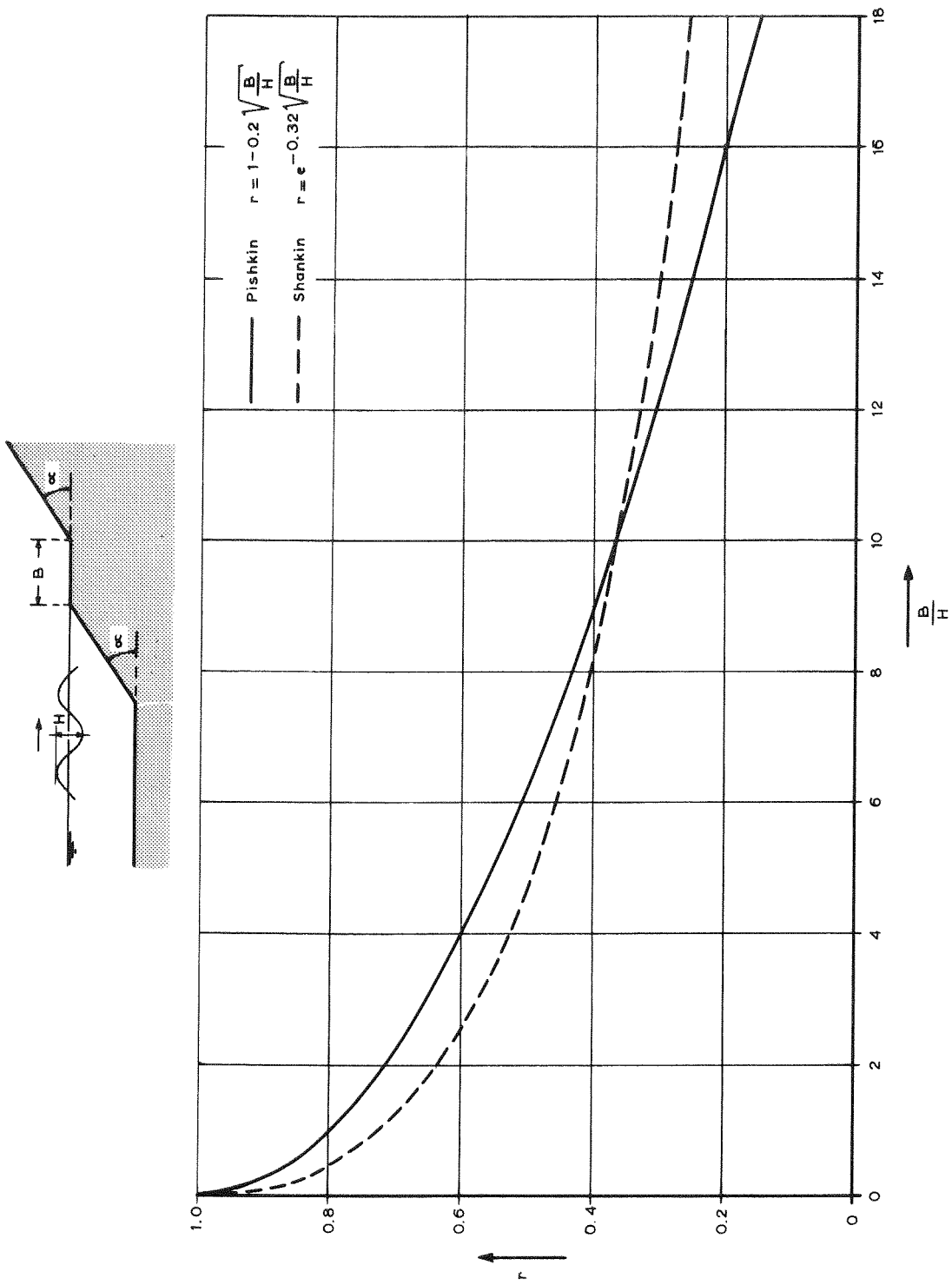
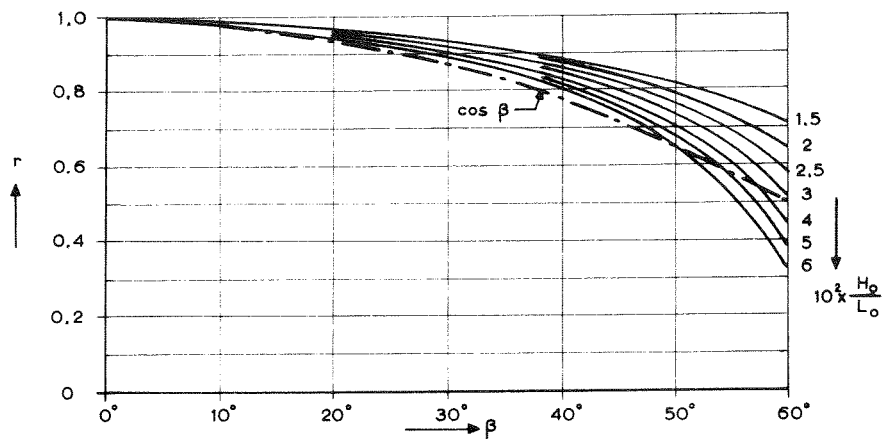

FIG. II. 5.25

waves on a plane slope in a multiplication factor $\cos \beta$, in which β is the angle between the wave propagation direction and the horizontal component of the normal to the slope. For breaking waves with perpendicular incidence, run-up is proportional to the slope gradient $\tan \alpha$. For incidence at an angle β , the component of the gradient in the propagation direction is equal to $\tan \alpha \cos \beta$. It is not known whether Djounkowski determined the factor $\cos \beta$ on this basis or in the light of measurements.

Hosoi and Shuto (1964) present experimental data relating to the influence of the direction of incidence on the run-up of regular waves on a plane slope. The angle of incidence β was 0° , 30° , 45° and 60° ; the slope gradient was 1:2. Figure II.5.26 shows the results of the measurements. The direction of incidence clearly has a greater influence on run-up when the waves are steeper. It should be noted that the lines partly relate to non-breaking and partly to breaking waves. According to figure II.3.1 the critical steepness is approx. 4% for perpendicular incidence on a slope with gradient 1:2. On this basis it should be expected that only the two lines shown in figure II.5.26 for steepness values greater than 4% relate to breaking waves. For $\beta < \text{approx. } 50^\circ$, the corresponding r values appear to be approximately equal to $\cos \beta$.



$$0.02 \text{ m} \leq H \leq 0.12 \text{ m}$$

$$1.2 \text{ s} \leq T \leq 1.6 \text{ s}$$

$$0.11 \leq \frac{d}{L_0} \leq 0.22$$

$$0.005 \leq \frac{H_0}{L_0} \leq 0.06$$

$$\tan \alpha = 1:2$$

FIG. II . 5. 26

II.6 REFERENCES

- Amein, M.: "Bore inception and propagation by the nonlinear wave theory", Proceedings 9th Conference Coastal Eng., Lisbon, p. 70-81, 1964.
- Amein, M.: "A method for Determining the Behavior of long waves climbing a sloping beach", Journ. of Geophysical Res., 71, nr.2, Jan.1966, p. 401-410.
- Bendykowska, G.: "Investigations in height of wave run-up on smooth impermeable steep slope", Rozprawy Hydrotechniczne, 23, p. 99-106, 1969 (in Polish, with English summary).
- Asbeck, W.F., Ferguson, H.A. and Schoemaker, H.J.: "New designs of breakwaters and seawalls with special reference to slope protection", 18th Int.Nav.Congress, Rome, Section II, Question I, p. 169-198, 1953.
- Bondi, H.: "On the problem of breakers", Admiralty Computing Service, WA-2304-13, 1943.
- Brillouet, G.: "Etude de quelques problèmes sur les ondes liquides de gravité", Publ. Scientifiques et Techniques du Ministère de l'Air, nr. 329, 145 pages, 1957.
- Bruun, P.: "Breakwaters for Coastal Protection", 18th Int.Nav. Congress, Rome, Section II, Question I, p. 5-43, 1953.
- Camfield, F.E. and Street, R.L.: "The effects of bottom configuration on the deformation, breaking and run-up of solitary waves", Proc. XIth. Conf.Coastal Eng., London, vol.I, p. 173-189, 1968.
- Camfield, F.E. and Street, R.L.: "Observations and Experiments on Solitary Wave Deformation", Proc. Xth. Conf.Coastal Eng., Tokyo, Vol.I, p. 284-301, 1966.
- Carrier, G.F.: "Gravity waves on water of variable depth", Journ. of Fl.Mech., 24, nr.4, p. 641-659, April 1966.

- Carrier, G.F. and Greenspan, H.P.: "Water waves of finite amplitude on a sloping beach", Journ. of Fl.Mech., 4, p. 97-109, 1958.
- C.E.R.C.: "Shore protection, planning and design" Techn.Rep.nr.4, 3d edition, 1966.
- Daubert, A. and Warluzel, A.: "Modèle mathématique non linéaire de la propagation d'une houle et de sa réflexion sur une plage", Proc. 12th Congress I.A.H.R., Fort Collins, Colorado, vol.4, p. 291-296, Sept. 1967.
- Delft Hydraulics Laboratory, Report M 544/1: "Golfoploop en golf-drukken op dijktaluds" ("Wave run-up and wave pressures on dike slopes") 1957, (in Dutch).
- Delft Hydraulics Laboratory, Report M 568: "Remmende invloed op golfoploop door ribbels op gesloten dijkbekleding" ("Reduction of wave run-up due to ribs on impermeable dike facing"), 1957 (in Dutch).
- Diephuis, J.G.H.R., Grijm, W., Schijf, J.B. and Venis, W.A.: "Golven en golfoploop" ("Waves and wave run-up"), Report Deltacommission, part 6, p. 7-22, 1961 (in Dutch).
- Drogosz-Wawrzyniak, L.: "Calculation of height of wave rushing up the slopes and the range of slope revetments", Archivium Hydrotechniki, 4, p. 323-336, 1965.
- Ertel, H.: "Kinematische Approximation der Wellenauflaufhöhe an Böschungen", Wasserwirtschaft-Wassertechnik, 18, nr.8, p.278-280, Aug.1968.
- Franzius, Ludwig: "Wirkung und Wirtschaftlichkeit von Rauhdeckwerken im Hinblick auf den Wellenauflauf", Mitteilungen des Franzius-Instituts für Grund- und Wasserbau der TH Hannover, Heft 25, p.149-268, 1965.
- Freeman, J.C. and LeMéhauté, B.: "Wave breakers on a beach and surges on a dry bed", Proc. ASCE, 90, nr. HY 2, March 1964.

- Friedrichs, K.O.: "Water waves on a shallow sloping beach", Comm. Appl.Math., 1, p. 109-134, 1948.
- Granthem, K.N.: "Wave run-up on sloping structures", Trans.A.G.U., 34, nr.5, p. 720-724, 1953.
- Greenspan, H.P.: "On the breaking of water waves of finite amplitude on a sloping beach", Journ.of Fl.Mech., 4, p. 330-334, 1958.
- Hall, J.V. and Watts, G.M.: "Laboratory Investigation of the vertical rise of solitary waves on impermeable slopes", Techn.Mem.33, B.E.B., U.S. Army Corps of Eng., 14 pages, 1953.
- Hanson, E.T.: "The theory of ship waves", Proc.Roy.Soc.London A, 111 p. 491-529, 1926.
- Henderson, F.M.: "Open channel flow", MacMillan, New York, 522 pages, 1966.
- Hensen, W.: "Modellversuche über den Wellenaufwurf an Seedeichen im Wattengebiet", Mitt. Hannoverschen Versuchsanstalt für Grundbau und Wasserbau, Heft 5, p. 123-165, 1954.
- Hensen, W.: "Modellversuche zur Bestimmung des Einflusses der Form eines Seedeiches auf die Höhe des Wellenaufwurfes", Mitt. Hannoverschen Versuchsanstalt für Grundbau und Wasserbau, Heft 7, p. 162-178, 1955.
- Hensen, W. and Führböter, A.: "Modellversuche über den Wellenaufwurf an den Elbdeichen bei Finkenwerder", Mitt. des Franzius Instituts, TH Hannover, Heft 21, p. 82-101, 1962.
- Herbich, J.B., Sorensen, R.M. and Willenbrock, J.H.: "Effect of berm on wave run-up on composite beaches", Proc. ASCE, 89, nr. WW2, p. 55-72, May 1963.
- Ho, D.V. and Meyer, R.E.: "Climb of a bore on a sloping beach, part 1", Journal of Fl.Mech., 14, p. 305-318, 1962.
- Ho, D.V., Meyer, R.E. and Shen, M.C.: "Long surf", Journal of Marine Research, 21, nr. 3, p. 219-230, 1963.

- Hosoi, M. and Shuto, N.: "Run-up height on a single slope dike due to waves coming obliquely", Coastal Eng. in Japan, 7, p. 95, 1964.
- Hudson, R.Y.: "Laboratory Investigations of Rubble-Mound Breakwaters", Proc. ASCE, 85, nr. WW3, paper 2171, Sept. 1959.
- Huitema, T.: "Golfoploop tegen dijken en de middelen daartegen" ("Wave run-up on dikes, and means to control it") OTAR, 39, nr.7, p. 154-156, 1955 (in Dutch).
- Hundt, C.: "Wellenaufwurf an Deichen und Deckwerken, Erfahrungen und Erkenntnisse vor der Schleswig-Holsteinischen Westküste", Wasser und Boden, 9, p. 43-48, 1957.
- Hunt, I.A.: "Design of seawalls and breakwaters", Proc. ASCE, 85, nr. WW3, p. 123-152, Sept. 1959.
- Hydraulics Research Station, Wallingford: "Hydraulics Research", p. 32-36, 1966.
- Iribarren, C.R. and Nogales, C.: "Protection des ports", Section II, Comm.4, XVIIth Int. Nav. Congress, Lisbon, p. 31-80, 1949.
- Isaacson, E.: "Water waves on a sloping bottom", Comm. Pure and Appl. Math., 3, p. 1-32, 1950.
- Iwagaki, Y., Shima, A. and Inoue, M.: "Effects of Wave Height and Sea Water Level on Wave Overtopping and Wave Run-up", Coastal Eng. in Japan, 8, p. 141-151, 1965.
- Jeffrey, A.: "The breaking of waves on a sloping beach", Zeitschr. Angew. Math. Phys., 15, p. 97-106, 1964, Zeitschr. Angew. Math. Phys., 16, p. 712, 1965.
- Jelgerhuis Swildens, J.C.: "Remmende invloed op golfoploop door ribbels op gesloten dijkbekleding" ("Reduction of wave run-up due to ribs on an impermeable dike facing"), De Ingenieur, 69, nr.29, p. B65-B69, 1957 (in Dutch).

- Jelgerhuis Swildens, J.C.: "Middelen tot vermindering van de golfoploop" ("Means for reduction of wave run-up"), De Ingenieur, 69, nr. 39, p. B81, 1957 (in Dutch).
- Jelgerhuis Swildens, J.C.: "Doelmatigheid van asfaltribbels tegen golfoploop bij storm" ("Effectiveness of asphalt ribs against wave run-up during storms"), De Ingenieur, 70, nr. 8, p. B40, 1958 (in Dutch).
- Jelgerhuis Swildens, J.C.: "Asfaltribbels op gesloten dijkbekleding ter beperking van de golfoploop" ("Asphalt ribs on impermeable dike facings for the reduction of wave run-up"), Polytechn.Tijdschrift B, 5-6 p. 4, 1958 (in Dutch).
- Johnson, J.W.: "Rectangular artificial roughness in open channels", Trans. A.G.U., 25, p. 906-914, 1944.
- Kaplan, K.: "Generalized Laboratory Study of Tsunami Run-up", Tech.Memo. 60, B.E.B., 1955.
- Kaplan, K.: "Design problems involved in protection from tsunamis", Proc. ASCE, 82, nr. WW3, paper 968, May 1956.
- Kato, J.: "Shapes of shore structures (dikes) and its damping effect for wave forces, especially on wave run-up and wave pressure", Coastal Eng. in Japan, 2, p. 73-84, 1959.
- Keller, J.B.: "Tsunamis - water waves produced by earthquakes", Tsun. Hydrodyn. Conference, Honolulu, Hawaii 1961.
- Keller, J. and Keller, H.B.: "Water wave run-up on a beach", Part II, Office of Naval Research, Wash. D.C., DDC, nr. AD 623136, 1965.
- Keller, H.B., Levine, D.A. and Whitham, G.B.: "Motion of a bore over a sloping beach", Journ. of Fluid. Mech., 7, p. 302-316, 1960.
- Kirchhoff, G.: "Ueber stehende Schwingungen einer schweren Flüssigkeit", Annalen der Physik und Chemie, X, p. 34-46, 1879; (also in : Monatsber. Akad. d. Wiss. zu Berlin, p. 395-410, 15 May 1879; Gesammelte Abhandlungen, Leipzig, p. 428-442, 1882).

- Kishi, T.: "Experimental study of wave run-up on sea wall and shore slope", Journ. of Research. of publ. Work Res.Inst., Tokyo, 3, Res. paper 4, 7 pp, March 1958.
- Kishi, T.: "Transformation, breaking and run-up of a long wave of finite height", Proc. 8th Conf.on Coastal Eng., Mexico, p. 60-76, 1962.
- Kishi, T. and Saeki, H.: "The shoaling, breaking and run-up of the solitary wave on impermeable rough slopes", Proc. Xth Conf. Coastal Eng., Tokyo, vol. 1, p. 322-348, 1966.
- Le Méhauté, B.: "On non-saturated breakers and the wave run-up", Proc. 8th Conf. Coastal Eng., Mexico, p. 77-92, 1962.
- Le Méhauté, B., R.C.Y.Koh and Li-San Hwang: "A synthesis on wave run-up", Proc. ASCE, 94, nr.WW1, p. 77-92, February 1968.
- Le Méhauté, B. and Moore, M.: "On the wave run-up of Solitary Waves", U.S.-Japan Cooperative Sci. Res. Seminars on Tsunami Run-up, Sapporo, Japan, April 1965.
- Lewy, H.: "Water waves on sloping beaches", Bulletin of the American Math.Society, vol. 52, 1946.
- Miche, R.: "Mouvements ondulatoires de la mer en profondeur constante ou décroissante", Annales des Ponts et Chaussées, 114e Année, 1944.
- Miche, R.: "Le pouvoir réfléchissant des ouvrages maritimes exposés à l'action de la houle", Annales des Ponts et Chaussées, 121e Année, p. 285-319, May-June 1951.
- Miller, R.L.: "Experimental determination of run-up of undular and fully developed bores", Journal of Geophys. Res., 73, nr. 14, p. 4497-4510, July 1968.
- Morris, H.M.: "A new concept of flow in rough conduits", Trans. ASCE, 120, p. 373-410, 1955.

- Penney, W.C. and Price, A.T.: "Finite periodic stationary gravity waves in a perfect liquid, Part II, Some gravity wave problems in the motion of perfect liquids", Phil. Trans. Roy. Soc., London, A, 244, nr. 882, p. 254-284, March 1952.
- Peters, A.S.: "The effect of a floating mat on water waves", Comm. on Pure and Applied Math., 3, p. 123-148, 1950.
- Peters, A.S.: "Water waves over sloping beaches and the solution of a mixed boundary value problem for $\Delta\varphi - \kappa^2\varphi = 0$ in a sector", Comm. Pure and Applied Math., 5, p. 87-108, 1952.
- Pilon, J.J.: "Wellenbremsende Konstruktionen bei Uferdeckwerken in Asphaltbauweise in Holland und ihre wirtschaftliche Bedeutung", Bitumen, H.3, 1960.
- Pocklington, H.C.: "Standing waves parallel to a plane beach", Proc. Cambr. Phil. Soc., vol. XX, p. 308-310, 1921.
- Roseau, M.: "Sur les mouvements ondulatoires de la mer sur une plage", C.R. Acad. Sci., Paris, 232, p. 211-213 and p. 479-481, 1951.
- Roseau, M.: "Contributions à la theorie des ondes liquides de gravité en profondeur variable", Publications Scientifiques et Techniques du Ministère de l'Air, nr. 275, 1952.
- Sato, S. and Kishi, T.: "Experimental study of wave run-up on seawall and shore slope", Coastal Eng. in Japan, 1, p. 39-43, 1958.
- Savage, R.P.: "Modeltests of wave run-up for hurricane project", Bull. Beach Erosion Board, 11, nr. 1, p. 1-12, 1957.
- Savage, R.P.: "Wave run-up on roughened and permeable slopes", Proc. ASCE, 84, nr. WW3, paper nr. 1640, May 1958.
- Savage, R.P.: "Laboratory Data on wave run-up on roughened and permeable slopes", B.E.B., Tech.Mem. 109, March 1959.
- Savage, R.P.: "A graphical method for checking the design height of structures subjected to wave run-up", The annual Bulletin of the B.E.B., Wash., Dept. of the Army, 16, p. 1-5, July 1961.

- Saville, T., Jr.: "Laboratory data on wave run-up and overtopping on shore structures", B.E.B., Tech. Mem. 64, 1955.
- Saville, T., Jr.: "Wave run-up on shore structures", Proc. ASCE, 82, nr. WW2, April 1956.
- Saville, T., Jr.: "Wave run-up on composite slopes", Proc. 6th Conf. Coastal Eng., Gainesville, p. 691-700, 1958.
- Schijf, J.B.: "Middelen tot vermindering van de golfoploop" ("Means for reduction of wave run-up"), De Ingenieur, 69, nr. 39 p. B80, 1957 (in Dutch).
- Shen, M.C. and Meyer, R.E.: "Climb of a bore on a sloping beach, parts 2 and 3", Journal of Fl. Mech., 16, p. 108-112 and p. 113-125, 1963.
- Shuto, N.: "Run-up of long waves on a sloping beach", Coastal Eng. in Japan, X, p. 23-38, December 1967.
- Shuto, N.: "Three-dimensional behaviour of long waves on a sloping beach", Coastal Eng. in Japan XI, p. 53-57, December 1968.
- Sibul, Oswald: "Flow over reefs and structures by wave action", Trans. A.G.U. 36, nr. 1, p. 61-69, February 1955.
- Sidorowa, A.G.: "The heights reached by waves on banks", Summary in: Appl. Mech. Rev., 13, nr. 1551, 1960.
- Stoker, J.J.: "Surface waves in water of variable depth", Quarterly of Appl. Math., 5, nr. 1, p. 1-54, 1947.
- Stoker, J.J.: "The formation of breakers and bores", Comm. on Pure and Appl. Math., 1, p. 1-87, 1948.
- Stoker, J.J.: "The breaking of waves in shallow water", Annals of the New York Academy of Sciences, 51, art. 3, p. 360-375, 1949.
- Stoker, J.J.: "Water waves", Interscience Publishers, Inc., New York, 1957.

- Tainan Hydraulic Lab.: "Report on the model test of sea dike cross-section of Hsin-Chu tidal land", Water Res.Planning Commission, Bull. 6, July 1963.
- Taylor, G.I.: "An experimental study of standing waves", Proc. Roy. Soc. London, A, 218, nr. 1132, p. 44-59, June 1953.
- Tominaga, Y., Hashimoto, H. and Sakuma, N.: "Wave run-up and overtopping on coastal dikes", Proc. 10th Conf. Coastal Eng., Tokyo, part I, p. 364-381, 1966.
- Van Dorn, W.G.: "Run-up recipe for periodic waves on uniformly sloping beaches", Proc. 10th Conf. Coastal Eng., Tokyo, part I, p. 349-363, 1966.
- Wagner, H.: "Kennzeichnung der Wellenauflaufhöhe an geraden, glatten undurchlässigen Böschungen im brandenden Bereich", Wasserwirtschaft-Wassertechnik, 18, nr. 9, Sept., p. 297-302, 1968.
- Wagner, H.: Personal communication with J.A.Battjes, 1969.
- Wallace, N.R.: "Deformation of solitary waves, part I: Reflection from a vertical wall", Report nr. URS 631-1, 56 p., Oct. 1963.
- Wallace, N.R.: "Deformation of solitary waves, Part II: Shoaling", Report nr. URS 631-2, 52 pages, May 1964.
- Wallace, N.R.: "Deformation of solitary waves on a 45° slope", Specialty Conference on Coastal Engineering Santa Barbara, Oct. 1965, p. 347-368.
- Wassing, F.: "Model investigations of wave run-up on dikes carried out in the Netherlands during the past twenty years", Proc. 6th Conf. Coastal Eng., Gainesville, Fla, Part IV, p. 700-714, 1957.
- Whitham, G.B.: "On the propagation of shock waves through regions of non uniform area or flow", Journ. of Fl. Mech., 4, p. 337-360, 1958.

Zitscher, F.F.: "Über den Wellenaufbau bei Asphaltdeckwerken",
Bitumen, 16 Jahr, Heft 3, April 1954.

Zitscher, F.F.: "Analyse zur Bemessung von Aussenböschungen schar-
liegender Seedeichen gegen Wellenbeanspruchung", Wasser und
Boden, Heft 10, p. 337-349, 1962.

PART III

RUN-UP OF IRREGULAR WAVES

III.1 INTRODUCTION

The structure of Part III, dealing with the run-up of irregular waves, coincides with that of Part II. In a number of instances the content of a section of Part III will consist solely of an indication of the fact that no data are available for irregular waves under that particular heading.

III.2 PARAMETERS

The independent parameters which determine the run-up of irregular waves on a slope can be divided into those which characterize:

- a) the construction;
- b) the water;
- c) the wave movement and
- d) the wind.

a) and b) The parameters in question are identical to those referred to in chapter II.2.

c) A first approximation to a description of irregular waves is obtained by assuming that the wave phenomenon is linear, in which case the wave pattern may be interpreted as the sum of a large number of waves each with a given frequency, propagation direction and energy, behaving independently of each other. This approximation may only be used if the steepness is sufficiently low. The otherwise arbitrary wave pattern is then statistically determined if the energy per unit of area is known as a function of the propagation direction and frequency. This function is known as the two dimensional energy density spectrum. This spectrum is difficult to measure because it is necessary not only to know the wave pattern at a fixed point but also the correlation between the latter and the wave pattern in the environment.

If we confine ourselves to the wave pattern at a fixed point, the direction in space ceases to be an independent variable; the wave pattern is considered solely as a function of time. All energies which are associated with components of a given frequency but of different directions are added together. The total is considered solely as a function of frequency and the two dimensional energy density spectrum reduces to a one dimensional energy density spectrum, known simply as the energy spectrum.

The energy spectrum for an arbitrary irregular wave pattern of sufficiently low steepness therefore indicates the quantity of energy which must be attributed to respective component waves for the statistical characteristics of the sum of the components to be identical to those of the wave pattern in question, as a

function of time. To describe a wave pattern of this kind statistically, it is therefore sufficient to know the energy spectrum. In practice this may give difficulties because the spectrum cannot be determined precisely in a finite measuring time but only estimated. In such cases it is useful to measure in addition a number of other characteristic parameters of the wave pattern such as the distributions of the instantaneous water level, wave heights and periods and the correlation between height and period.

Waves which are relevant for design purposes are generally so steep that a linear theory is not adequate to describe them. The energy spectrum can then be determined but the component waves are not completely independent because they are partly coupled by non-linear influences. This coupling is clearly reflected in the fact that the crests become more peaked and the troughs flatter as the wave steepness increases. The consequence of this reciprocal influence of the different components is that the energy spectrum is no longer sufficient to describe an irregular wave pattern statistically. In these cases, it is necessary to determine in addition a number of other characteristic parameters of the wave pattern such as the distributions and correlation referred to in the previous paragraph.

Both the energy spectrum and the distributions of wave height, period etc. are completely determined by a length scale, a time scale and their shape. In general, a characteristic wave height H_k may be chosen for the length scale and a characteristic period T_k for the time scale. The definitions of these parameters may differ from case to case. It is not necessary to give the definitions in this chapter. When two parameters of identical type are defined in different manners, the one can always be determined from the other, as long as the forms of the spectrum and of the distribution functions are known.

The above considerations indicate how the wave movement at a particular point may be described as a function of time. The wave lengths can be approximately determined from this, provided that g , the gravitational acceleration, and d , the depth, are known. With respect to the distribution of the wave energy in

different directions, we shall content ourselves with indicating $\bar{\beta}$, an average direction of incidence in relation to the dike.

- d) The wind is partly characterized by ρ_a , the air density, \bar{w}_{10} , the time-averaged velocity at 10 m above the water level, and $\bar{\varphi}_w$, the average wind direction. If necessary a number of parameters may be added giving a more detailed description of the variation of the mean wind speed as a function of height and the instantaneous wind speed as a function of time.

The dependent variable is the run-up height z , the maximum height above the water level reached by a wave tongue running up against the slope. The run-up height is a stochastic variable. If n is the exceedance frequency, then $z_{(n)}$ is the dependent variable for a given or chosen n value.

The above may be summarized as follows:

$$z = f(\rho_w, \mu, \sigma, H_k, T_k, g; d, \bar{\beta}, \rho_a, \bar{w}_{10}, \bar{\varphi}_w, \text{form factors}, n, \lambda)$$

or

$$\frac{z}{H_k} = f\left(\frac{H_k}{d}, \frac{H_k}{gT_k^2}, Re_k, We_k, \frac{\rho_a}{\rho_w}, \frac{\bar{w}_{10}^2}{gH_k}, \bar{\beta}, \bar{\varphi}_w, \text{form factors}, n, \frac{H_k}{\lambda}\right)$$

(III.2.2)

Before presenting and discussing qualitative and quantitative experimental data concerning the influence of the dimensionless groups referred to above, the following chapter indicates non-experimental work which has been done.

III.3 THEORIES

III.3.1 Introduction

No theories are known concerning the run-up of irregular waves working on the basis of the laws of mechanics and probability theory. Some work of a non-experimental nature has been done by Saville (1962), who calculated the distribution of the wave run-up from the joint distribution of wave height and period assuming that individual waves in an irregular wave movement on average generate the same run-up as when they form part of a regular wave movement with corresponding height and period.

The run-up of an oncoming wave on a given slope does not depend only on the wave itself but also on the preceding wave movement. It may be expected that waves with the same H and T values will sometimes run up higher than the corresponding regular wave and sometimes less high. The assumption is that on average these effects cancel each other out. The validity of this assumption should be checked by comparison with measurements. This will be discussed in chapter III.5.

In Part II it was noted that the run-up of regular waves is influenced to a great extent by the fact whether the waves break on the slope, which is determined by the wave steepness H/L_0 and the slope gradient α . It may be expected that this will also be the case with irregular waves. The steepness of individual waves is, however, variable for a given wave train so that some of the waves will break and others not. In his calculations, Saville makes no explicit distinction between breaking and non-breaking waves. The problem becomes much simpler if all waves can be considered in an approximation to be either of the breaking or non-breaking variety. On the one hand the wave steepness in wind-driven waves is such that with slopes at a gradient of 1:3 or less, practically all waves break, while most waves run up without breaking at a gradient of 1:1½ or steeper.

Some results are given below for calculated run up distributions assuming that:

- no distinction is made between breaking and non-breaking (Saville, 1962);
- the waves are considered to break (Battjes, 1971); and
- the waves are considered not to break.

III.3.2 Run-up distributions

Working on the basis of the joint distribution of wave height and period as indicated by Bretschneider (1959) where the correlation between height and period is zero, Saville (1962) calculated numerically the distributions of run-up for plane slopes with gradients varying from 1:1½ to 1:6, and for wave steepnesses $H_{\frac{1}{3}}/g\bar{T}^2$ of 6.8×10^{-3} and 1.9×10^{-3} . $H_{\frac{1}{3}}$ is the mean height of the highest third of the waves and \bar{T} the arithmetic mean of the wave periods. The two steepness values used by Saville give practically identical results. Figure III.3.1 shows the distributions of $z/z_{\frac{1}{3}}$, where $z_{\frac{1}{3}}$ is the run-up of a regular wave with $H_{\frac{1}{3}}$ as its height and \bar{T} as its period, for the given slope gradients and a wave steepness of $H_{\frac{1}{3}}/g\bar{T}^2 = 6.8 \times 10^{-3}$.

To apply Saville's hypothesis it is necessary to know the run-up of a regular wave on a plane slope. For this purpose Saville uses the results shown in figures II.5.1 and II.5.2, from which he calculated the run-up distributions numerically. His hypothesis may, however, be used and elaborated analytically (Battjes, 1971) by considering only waves which break on the slope, in which case Hunt's formula (equation II.5.8) is applicable. Some results of this calculation are given below.

Hunt's formula is as follows:

$$z = \sqrt{HL_0} \tan \alpha \quad (\text{II.5.8})$$

The run-up height z is normalized by dividing by the factor $\sqrt{\bar{H}\bar{L}_0} \tan \alpha$ in which a bar indicates the arithmetic mean. The run-up normalized in this way is referred to as z' :

$$z' = \frac{z}{\sqrt{\bar{H}\bar{L}_0} \tan \alpha} \quad (\text{III.3.1})$$

which, after substituting equation II.5.8, becomes

$$z' = \sqrt{\frac{HL_0}{\bar{H}\bar{L}_0}} \quad (\text{III.3.2})$$

The probability P that the normalized run-up z' will be exceeded can be calculated from the joint distribution of the height and period of individual waves. $P(z')$ has been determined for two forms of this distribution:

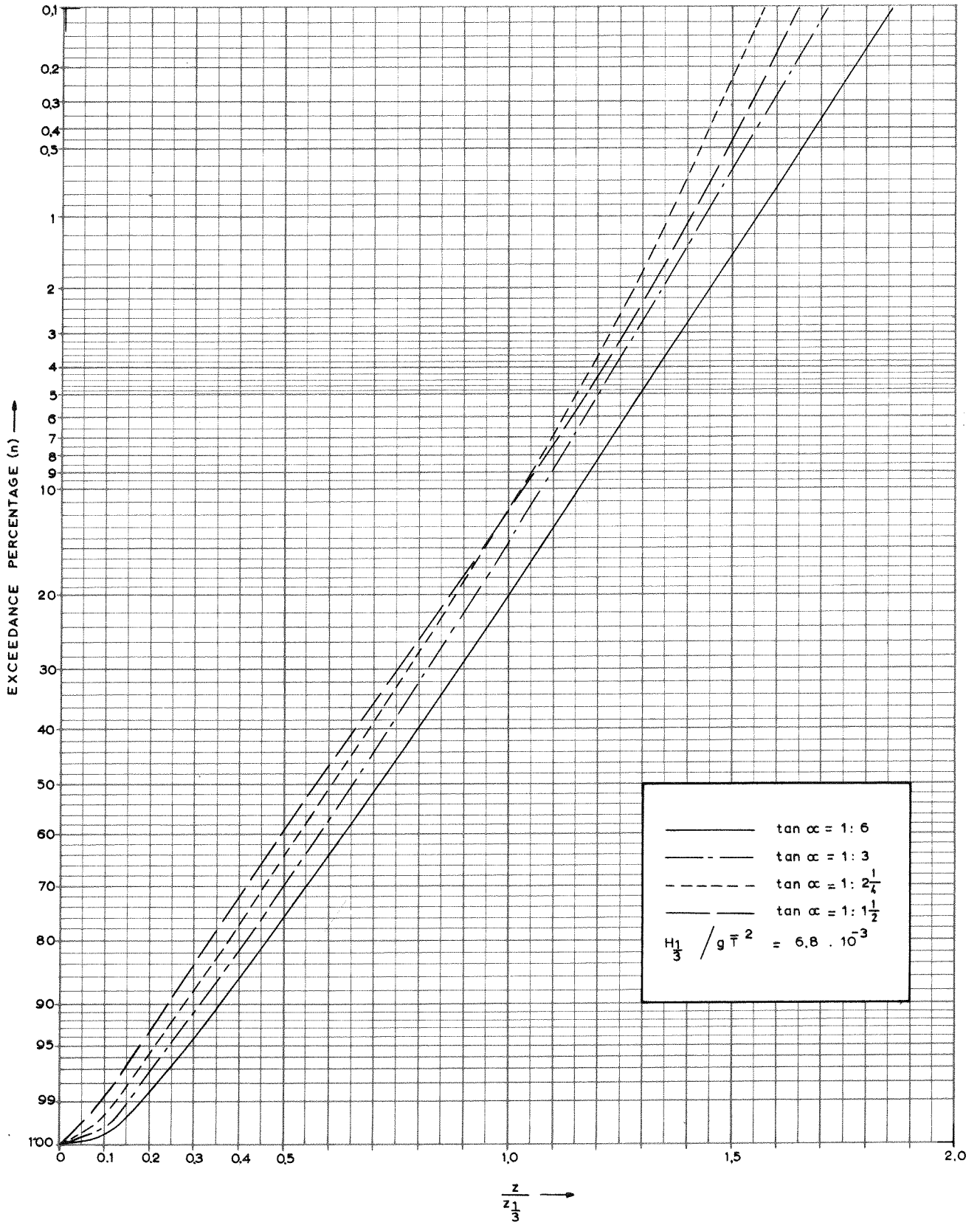

FIG. III. 3.1

- a) It is assumed in this case that L_0 is constant and that H is Rayleigh-distributed. This model is applicable, in an approximation, to swell; the probability of exceedance is given by

$$P(z') = e^{-\frac{\pi}{4} z'^4} \quad (\text{III.3.3})$$

This relationship is presented graphically in figure III.3.2.

- b) In this case it is assumed that H and L_0 have a joint Rayleigh distribution with the correlation coefficient ρ as a parameter ($0 \leq \rho \leq 1$). A formula has been derived for the run-up distribution in which ρ may assume any value between 0 and 1. Here the results are only shown for the limiting cases $\rho = 0$ and $\rho = 1$. According to Bretschneider (1959) $\rho = 0$ applies to a fully-developed sea while $\rho = 1$ is considered by him as a limit value associated with a young sea (with high wind speed and short fetch). In these instances the probability of exceedance is given by

$$P(z') = \frac{\pi z'^2}{2} K_1\left(\frac{\pi z'^2}{2}\right) \quad \text{when } \rho = 0 \quad (\text{III.3.4})$$

(K_1 is the modified Bessel function of the third kind and first order) and

$$P(z') = e^{-\frac{\pi}{4} z'^2} \quad \text{when } \rho = 1 \quad (\text{III.3.5})$$

These relationships are also shown in figure III.3.2.

In his calculation of run-up distributions, Saville assumes that H and L_0 have a joint Rayleigh distribution with $\rho = 0$. It is therefore useful to compare his results with equation III.3.4. For this purpose the relationship must be known between z' and the parameter z/z_1 used by Saville. It may be shown that in this case

$$z' = 1.22 \frac{z}{z_1} \quad (\text{III.3.6})$$

Only one of Saville's curves, i.e. that for $\tan \alpha = 1:6$, is shown in figure III.3.2. This coincides well with equation III.3.4. The other curves defined by Saville apply to relatively steep slopes (see figure III.3.1) and coincide less well with equation III.3.4, probably as a result of the fact that under the circumstances Hunt's formula is not entirely representative of the data used by Saville for the run-up of regular waves.

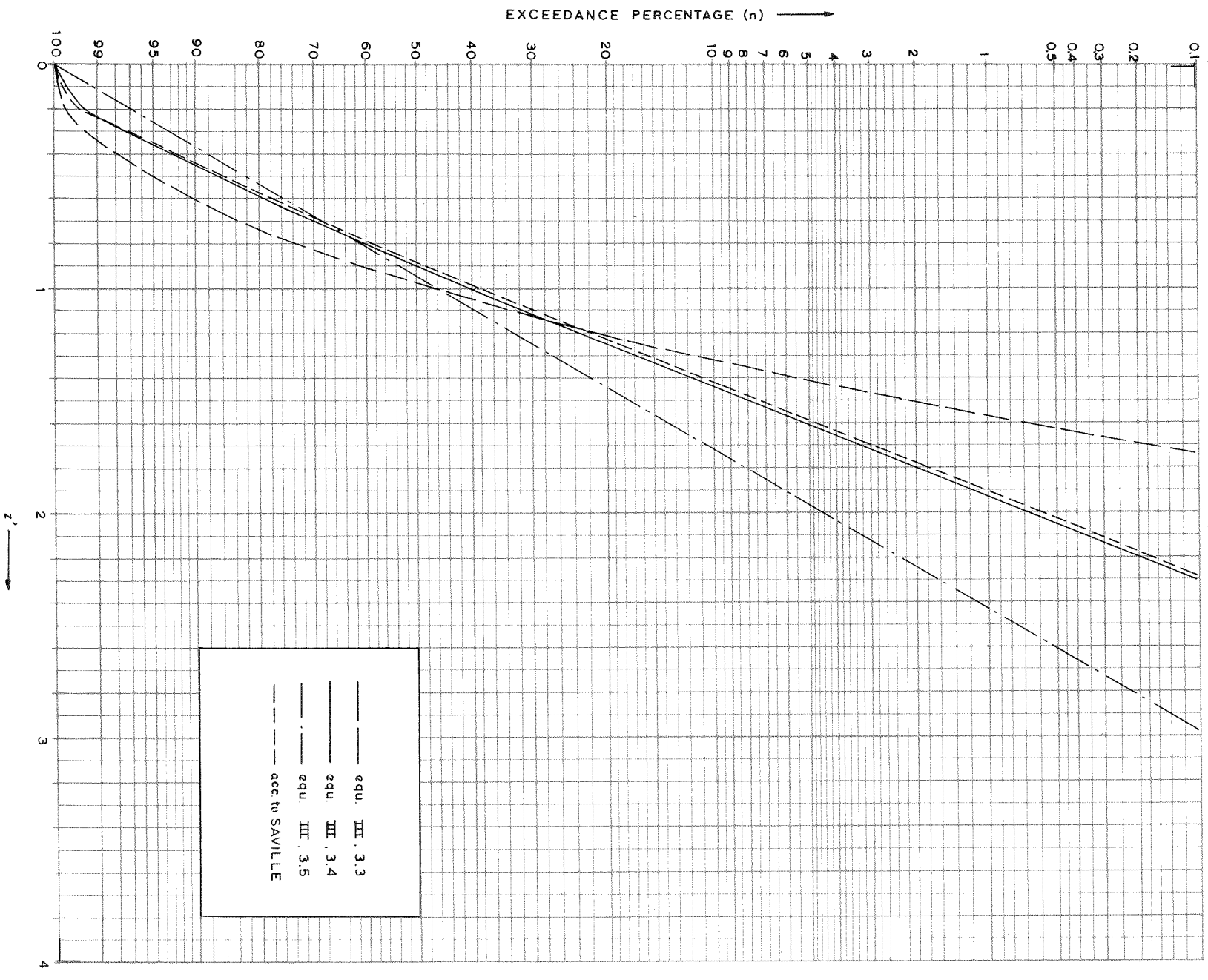

FIG. III. 3.2

A number of important conclusions can be drawn from figure III.3.2:

- 1) The older the wave movement causing the run-up, the smaller the dispersion of the run-up values.
- 2) In view of the above conclusion it seems reasonable to assume that the distributions of run-up associated with a young sea on the one hand and old swell on the other will be extreme values since these wave types may be considered as two extremes of the type of wave movement encountered under natural conditions.
- 3) The nature of the irregularity of the waves has the greatest influence on the larger run-up heights, i.e. those with the lower exceedance percentages. It is therefore necessary to have full information on the stochastic character of the wave movement, particularly for the run-up which is important for design purposes. This holds good regardless of whether the run-up distribution is determined analytically or by a scale model.
- 4) The values of $z'_{(2)}$ for the cases (a) and (b) referred to on page 101 and the corresponding formulae for 2% run-up are shown below:

$$(a) \quad z'_{(2)} = 1.5 \quad \text{or} \quad z_{(2)} = 1.5 \sqrt{H \bar{L}_0} \tan \alpha \quad (\text{III.3.7})$$

$$(b) \left\{ \begin{array}{l} \rho = 0 \\ \rho = 1 \end{array} \right. \quad z'_{(2)} = 1.8 \quad \text{or} \quad z_{(2)} = 1.8 \sqrt{H \bar{L}_0} \tan \alpha \quad (\text{III.3.8})$$

$$(b) \left\{ \begin{array}{l} \rho = 0 \\ \rho = 1 \end{array} \right. \quad z'_{(2)} = 2.25 \quad \text{or} \quad z_{(2)} = 2.25 \sqrt{H \bar{L}_0} \tan \alpha \quad (\text{III.3.9})$$

The experimental data concerning the run-up of non-breaking waves are so scanty that no relationship between the different variables can be derived from them, as was done in the case of breaking waves. The calculation of the run-up distribution can, however, be based on theoretical results for regular waves. Here we may work from Keller's formula (equation II.3.14):

$$z = \frac{1}{K_s} \cdot H \sqrt{\frac{\pi}{2\alpha}} \quad (\text{III.3.10})$$

K_s is the shoaling coefficient defined by equation II.3.7.

In calculating the run-up of non-breaking waves allowance must be made for a non-linear effect, i.e. that the wave crest extends up to

more than half the wave height above the average water level. This effect is not considered in equation III.3.10. It may be expressed by a correction factor δ :

$$z = \frac{1+\delta}{K_s} H \sqrt{\frac{\pi}{2\alpha}} \quad (\text{III.3.11})$$

The value of δ , which increases with H/L_0 and above all with L_0/d , may be as high as 30 or 40 per cent.

According to Saville's hypothesis, the run-up distribution of irregular, non-breaking waves can be calculated by attributing to individual waves a run-up according to equation III.3.11. If the relative variation of $(1+\delta)/K_s$ is disregarded, the run-up has the same distribution as the wave height:

$$z_{(n)} = \frac{1+\delta}{K_s} H_{(n)} \sqrt{\frac{\pi}{2\alpha}} \quad (\text{III.3.12})$$

If this common distribution is identical to the Rayleigh distribution equation III.3.12 can be converted to

$$z_{(2)} = 1.4 \frac{1+\delta}{K_s} H_{\frac{1}{3}} \sqrt{\frac{\pi}{2\alpha}} \quad (\text{III.3.13})$$

The derivations and conclusions given in this chapter are based partly on assumptions. Accordingly their importance lies in the fact that they can be used as guidelines in interpreting experimental data, considered in chapter III.5, and possibly also in further experimental research.

III.4. QUALITATIVE EXPERIMENTAL RESULTS

III.4.1 Introduction

In most of the studies carried out up to now of wave run-up, regular waves have been used because the facilities required for this purpose are fairly simple. Only in the Netherlands have studies been carried out with irregular waves for decades. In other countries work of this nature has begun very recently (Carstens et al, 1966, Webber and Bullock, 1968), with one exception (Sibul and Tickner, 1955). Most of the data indicated below therefore come from the Netherlands.

As to the influence of the various parameters discussed in chapter III.2, less is known than in the case of regular waves. This is a consequence of the fact that in general less attention has been given to irregular waves and also of the circumstance that this is a more complicated phenomenon in which it is less easy to recognize certain relationships. Moreover, when working with laboratory waves generated by wind it is only possible to a very limited extent to vary wave heights, periods and wind speed independently of each other, so that in the case of these waves it is difficult to investigate the influence of the variation of one of these parameters only. In this respect the more recent possibility of a combination of wind and mechanically generated irregular waves offers greater prospects.

The influence of different parameters on run-up of irregular waves on a smooth, plane slope is discussed from the qualitative angle below, in so far as data are available. Non-breaking waves cannot be considered because relevant data are lacking.

III.4.2 Slope angle α

Run-up increases with greater steepness of the slope. The same tendency is noted in the case of run-up of regular waves breaking on the slope.

III.4.3 Angle of incidence β

Run-up diminishes as the angle of incidence of the waves becomes more oblique. Initially the reduction is very slow; only with very oblique incidence ($\beta > \text{approx. } 40^\circ$) does the influence become significant.

III.4.4 Wave steepness H_k/gT_k^2

Run-up diminishes with increasing steepness, as in the case of breaking regular waves.

III.4.5 Ratio H_k/d

No data.

III.4.6 Reynolds number Re_k

No data.

III.4.7 Weber number We_k

No data.

III.4.8 Form of energy spectrum

It has been found that the form of the energy spectrum has a not insignificant influence on run-up. Two wave movements with the same total energy and characteristic period but with a different spectrum shape may cause run-up heights which differ both in regard to the mean value and to the distribution. There are indications that this influence is connected with the changes undergone by the H-T distribution when the spectrum shape varies.

It should be noted that the choice of a characteristic period T_k is not unambiguous; two wave fields may have the same T_k value in one definition but two different T_k values if a different definition is chosen. In this connection there is therefore a degree of subjectivity in comparing two irregular wave movements. In regard to the characteristic wave height the uncertainty is much smaller because wave height distributions differ far less in shape than period distributions or spectra.

III.4.9 Wind speed parameter \bar{w}_{10}^{-2}/gH_k

The wind may influence the run-up through the oncoming waves and also through its direct effect on the water running up the slope. The two effects have not been studied individually because it is difficult to separate them experimentally. In so far as conclusions have been drawn in literature concerning the wind influence these relate to the sum of the two effects. In this way the wind influence is also implicitly a function of the fetch.

A third consequence of the wind influence, namely the change in the average water level, can generally be taken into account, however.

One possible result of the wind effect is the change in the run-up distribution, which seems to assume a wider dispersion the stronger the gusts of wind. Even if the mean run-up value remains the same, the value exceeded by e.g. 2% of the number of run-ups may increase with the gustiness of the wind.

III.4.10 Wind direction $\bar{\varphi}_w$

No data.

III.5 QUANTITATIVE EXPERIMENTAL RESULTS

III.5.1 Introduction

Before presenting and discussing experimental data a short summary will be given of the corresponding measurements.

The oldest observations were taken under natural conditions and relate primarily to the flood mark. Since in the early days it was impossible to make accurate wave measurements, the run-up data could not be correlated with the characteristics of the oncoming waves. Partly as a result of this, the data were primarily of local validity. The Lorentz Commission (1926) generalized these data to some extent by correlating run-up with the water depth in front of the dike (figure III.5.1). This procedure made sense because the commission's terms of reference were "to investigate the extent to which closure of the Zuiderzee may lead to higher water levels and a greater wave run-up during stormy weather than is at present the case."

Flood mark observations were subsequently supplemented by run-up distribution measurements conducted mainly by the Zuiderzee Project Department. However, in this case too, knowledge of the incident waves left much to be desired.

In order to obtain more detailed knowledge of the run-up phenomenon, the Delft Hydraulics Laboratory carried out a series of systematic model studies of wave growth under the influence of wind, and the resulting run-up on a slope with a gradient of $1:3\frac{1}{2}$ (M 101, 1936), the influence of the shape and roughness of the slope (M 151, 1939) and the influence of the slope gradient (M 202, 1942). Apart from these systematic experiments, measurements were also made to determine the wave run-up in incidental cases. The principal test results are summarized in report M 544-1 (1957) and by Wassing (1958).

In the model the waves were generated either by wind alone or by a combination of wave board (with periodic movement) and wind. In both instances, the irregularity of the waves is considerably less than under natural conditions. This leads to problems when the model results must be used to predict wave run-up under natural conditions. A programmed wave generator combined with wind, as used by van Oorschot and d'Angremond (1968), should be given preference in this connection.

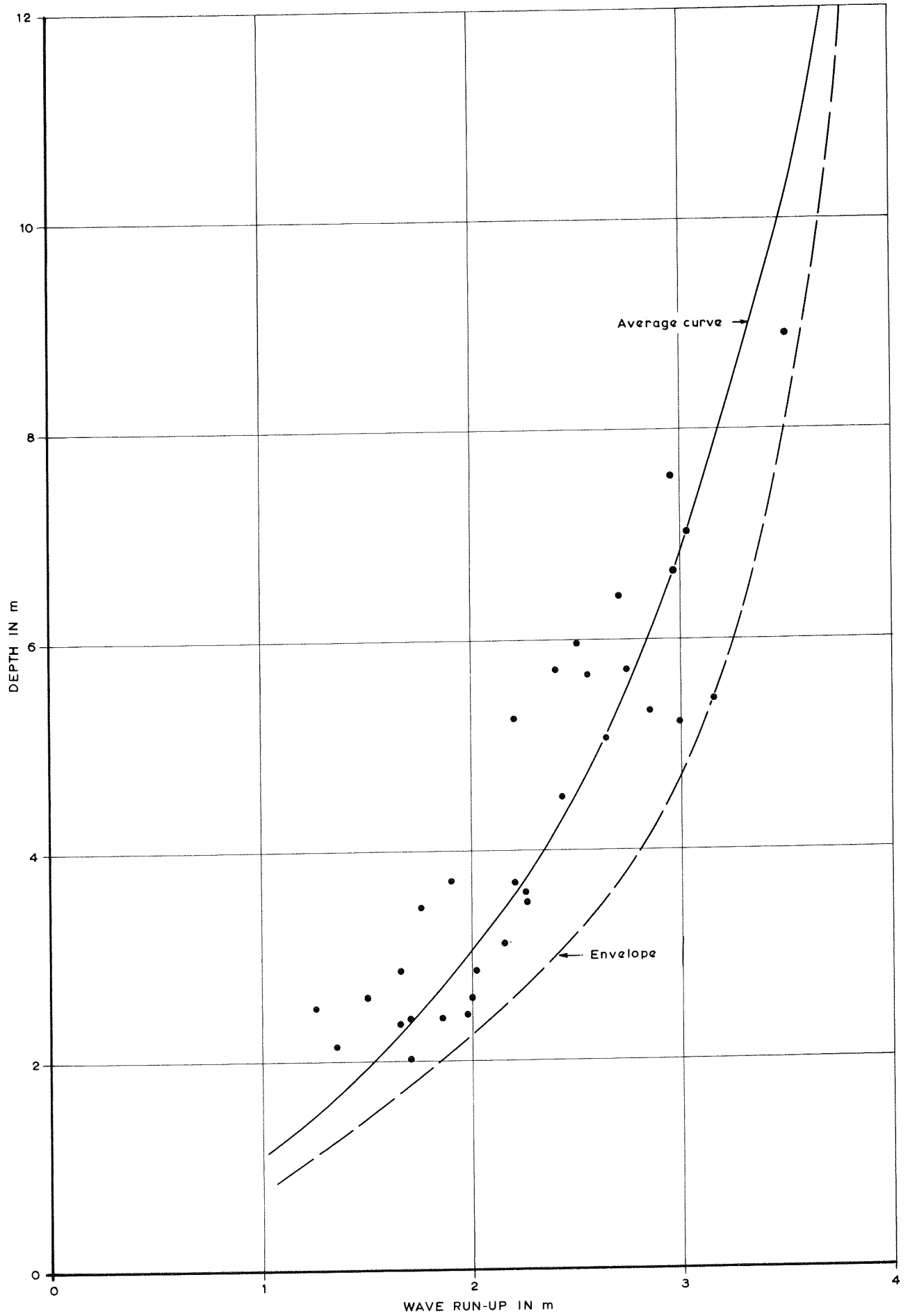

FIG. III.5.1

The above considerations show that the number of systematic measurements of the run-up of irregular waves is still fairly small. The available data will be dealt with in some detail below. The flood mark observations will not, however, be considered.

III.5.2 Field measurements

In 1943 and 1944 the Zuiderzee Project Department carried out measurements of wave run-up distributions on the North East Polder dike. The data are stored in the archives of the Delft Hydraulics Laboratory under reference number M 202. Good measurements of the incident waves were not available. Only in some cases was a visual estimate given of the "mean of the highest waves". The measurements are therefore used here only in so far as they relate to the shape of the run-up distribution. No attention is given to the magnitude of run-up.

Measurements were taken in two sectors, i.e. No II and No III, to the North and South of Urk respectively. These locations are shown in figure III.5.2, as is the cross-section of the dike.

Table III.5.1 contains data relating to the circumstances in ten measurements chosen on the basis of the criterion that the water level and wind speed must not change too greatly during the measurement.

No	Date	Wind speed		Section II hm 183		Section III hm 292	
		Value (m/s)	Direction	h(m)	z (50) ^(m)	h(m)	z (50) ^(m)
1	9- 8-'43	13	WNW-W	-0.12	0.34	-0.18	0.24
2	30- 8-'43	15 to 18	WSW t.W	-0.10	0.31	-0.05	0.38
3	15- 9-'43	13	SW	-0.07	0.36	-0.09	0.46
4	15- 9-'43	13	WSW	-0.21	0.36	-0.21	0.36
5.	20- 9-'43	13 to 17	WSW t.S	-0.05	0.40	-0.10	0.65
6.	22- 1-'44	20 to 25	SSW	+0.05	0.45	+0.05	0.50
7	13- 3-'44	15 to 20	WNW	-0.05	0.48	-0.05	0.50
8	3- 5-'44	15 to 20	WNW t.W	+0.20	0.43	-	-
9	7-11-'44	20 to 25	W	+0.40	0.85	+0.40	1.00
10	7-11-'44	20 to 25	W	+0.50	1.02	+0.50	1.08

') Very gusty; repeatedly greater than 25 to 30 m/s.

TABLE III.5.1

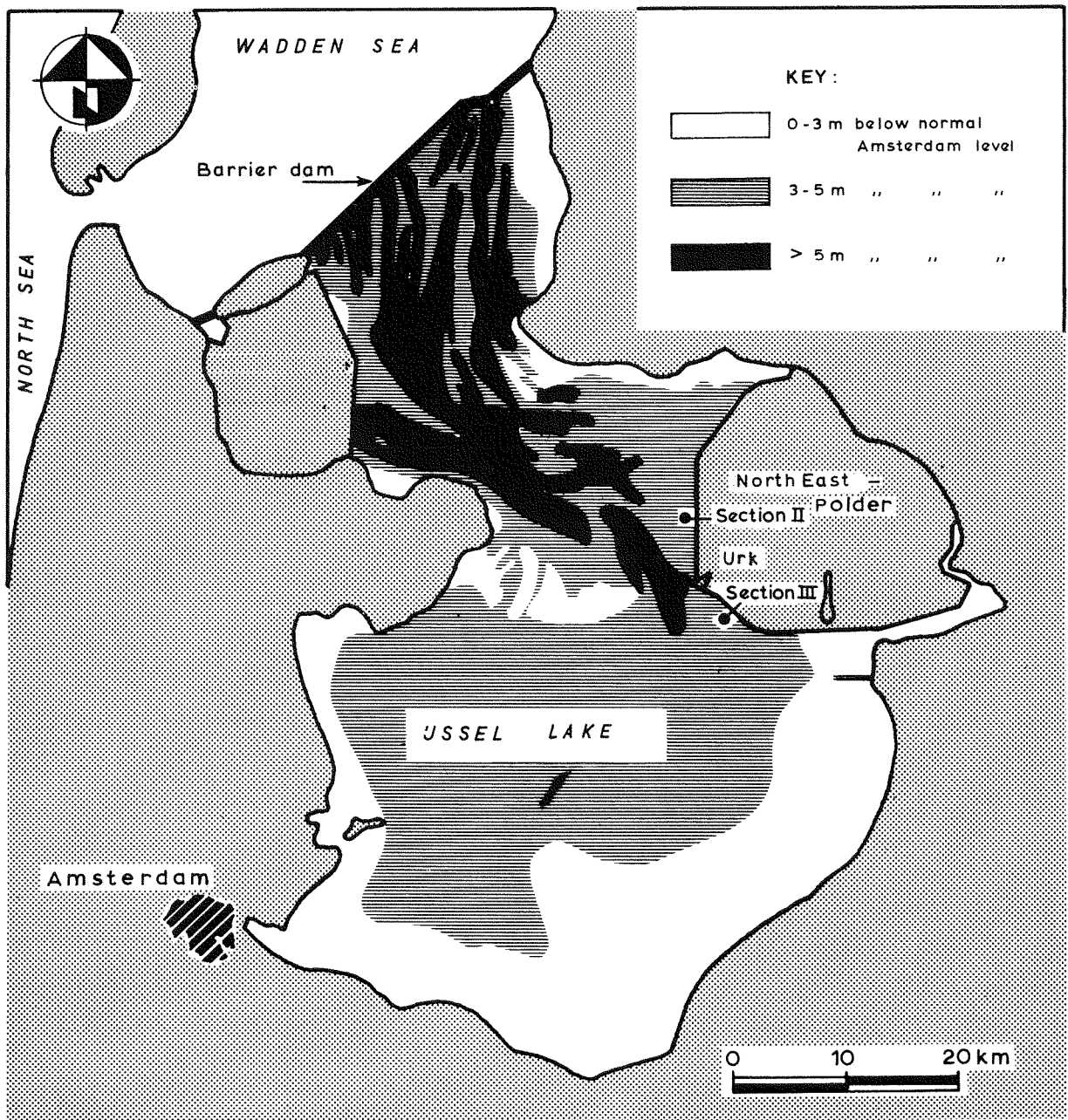

SITUATION

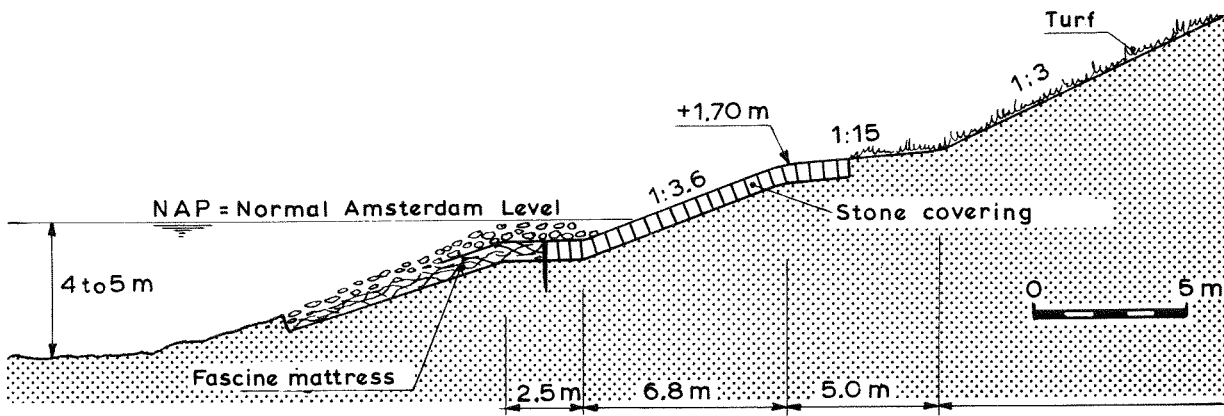

CROSS SECTION

FIG. III. 5.2

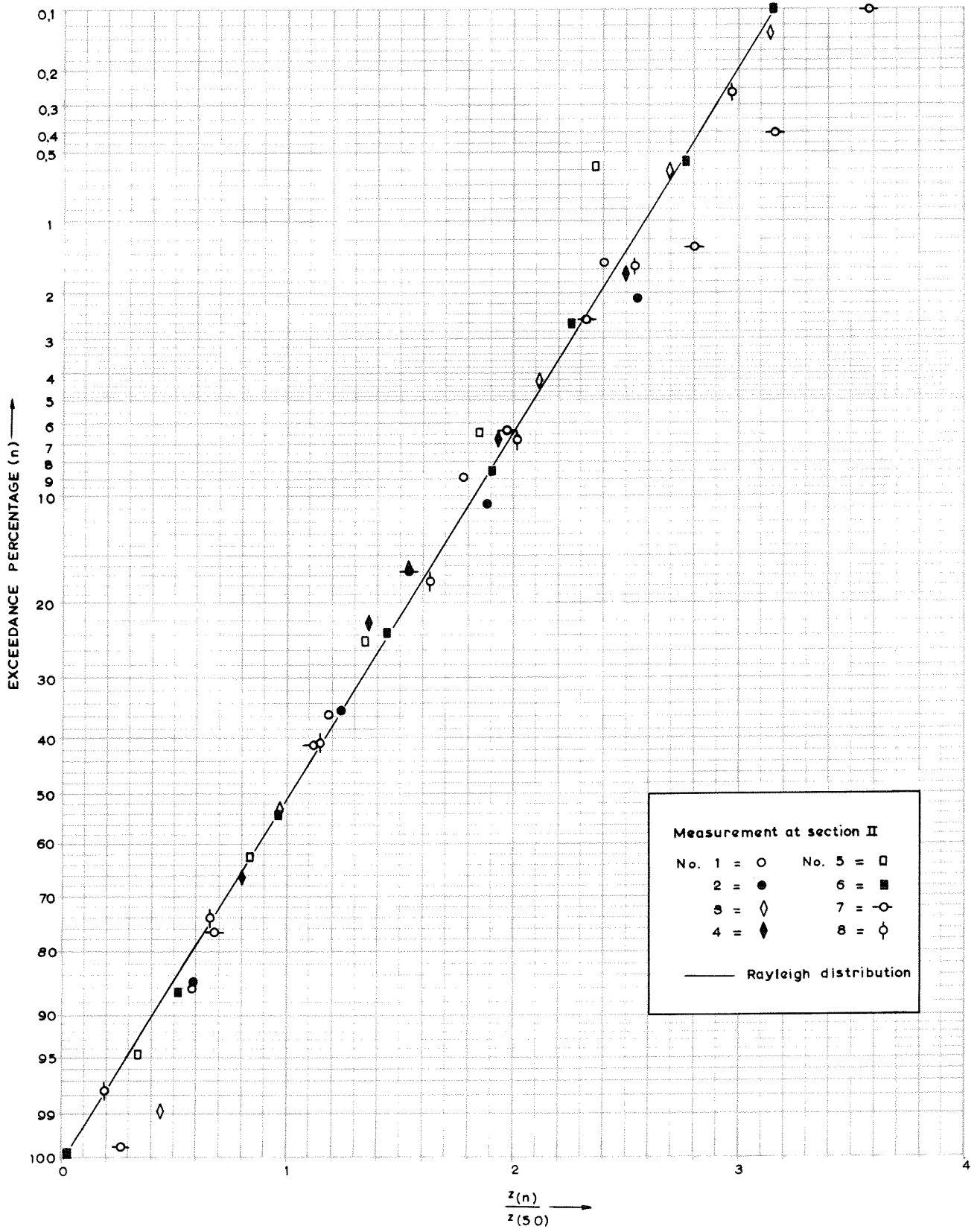
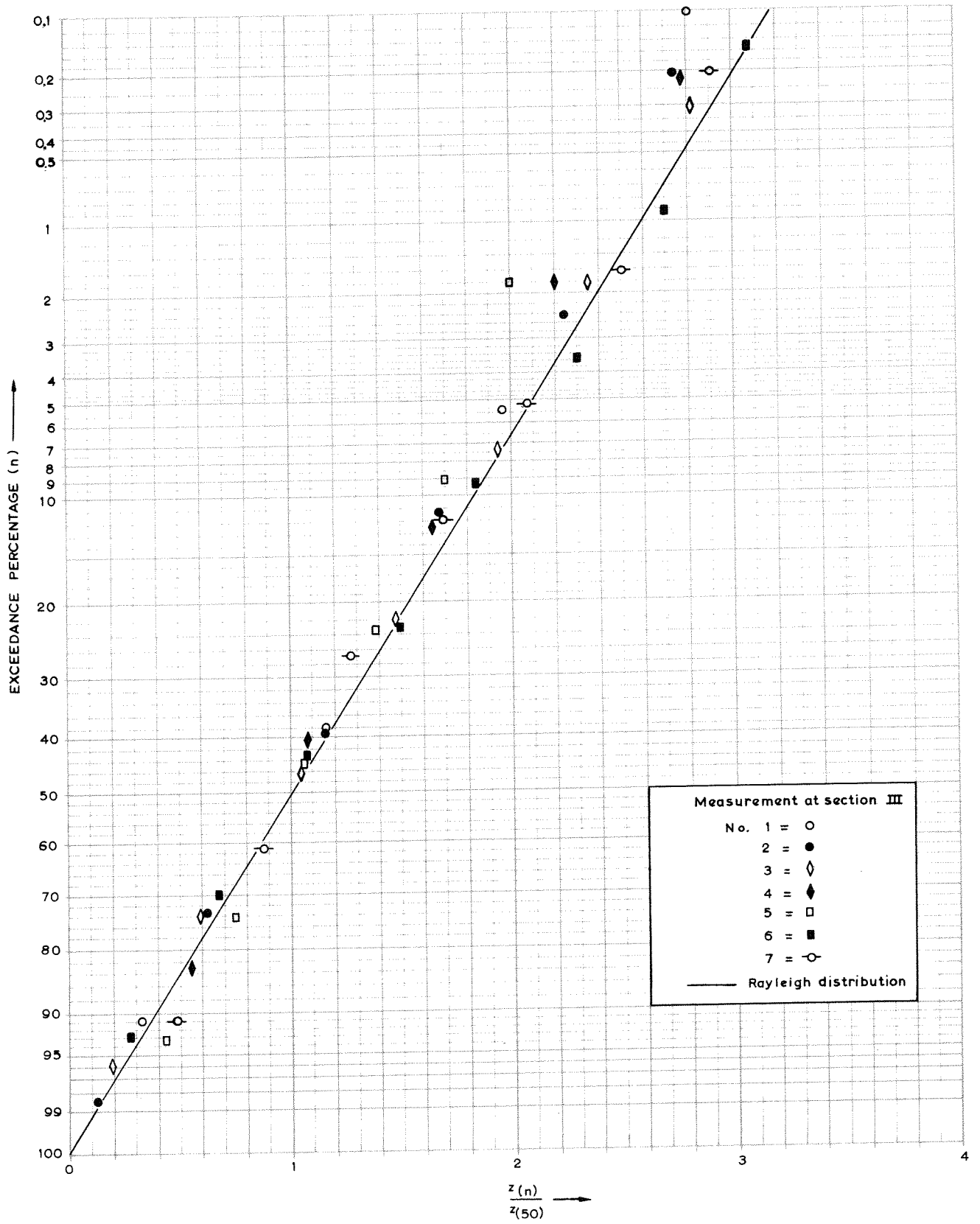

FIG. III. 5.3



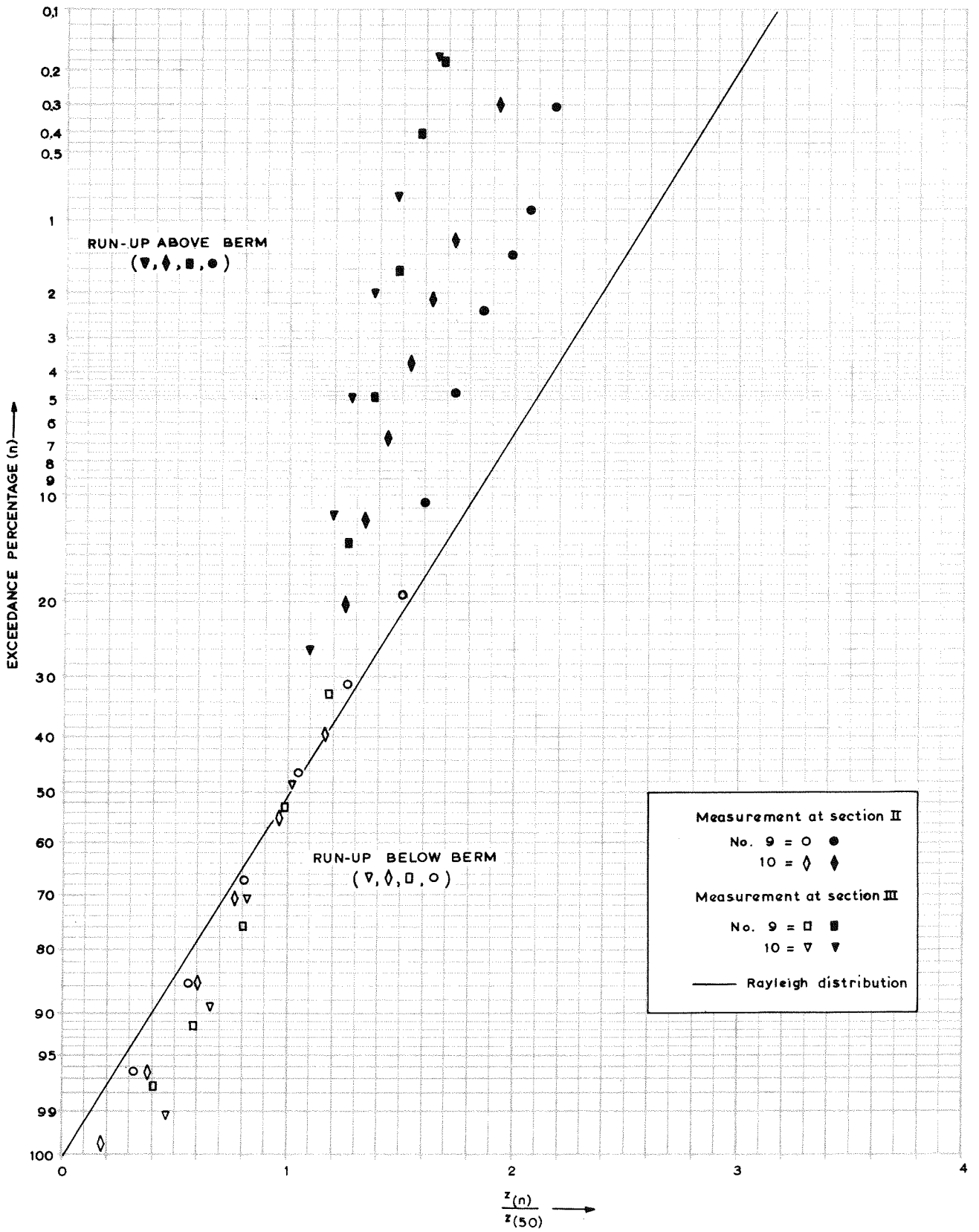

FIG. III. 5.5

The results of the measurements in which run-up remained below the upper berm are shown in figures III.5.3 and III.5.4 for section II and section III respectively, and the remainder in figure III.5.5. In the latter figure the influence of the upper berm on the shape of the run-up distribution is clear. Distributions 9 and 10 show a sharp bend at the level of the berm so that the dispersion is much less than in the case of the distributions shown in figures III.5.3 and III.5.4.

In the case of the latter run-up distributions it is striking that they all have approximately the same shape. An exception is provided by measurement 7 in section II which shows a wider dispersion than the others. An explanation of this may be given by the fact that the wind was very gusty during this measurement (see table III.5.1).

Figures III.5.3 and III.5.4 show that the measured distributions differ only slightly from a Rayleigh distribution. With the exception of measurement 7 for section II the deviations are such that the Rayleigh distribution gives an upper limit for the dispersion.

The Vlissingen Study Department of the Rijkswaterstaat conducted visual wave run-up observations in the years 1947 to 1954 at the Westkapelse sea dike. Wave observations are not available. In the relevant report (Rijkswaterstaat, 1955) a comparison is given of the run-up heights measured simultaneously on adjacent dike sections with different roughness and slope gradient. The average of the highest five observations in a series of 10 minutes was taken as a measure of the run-up. The results were used to test the hypothesis that run-up is proportional to $\tan \alpha$. The measurements did not conflict with this assumption. Because of the wide dispersion of the results, a more positive conclusion is difficult to arrive at.

III.5.3 Plane, smooth slope

The first systematic experiments to determine the run-up of wind generated waves were carried out in 1936 (M 101). Both the generation of waves by wind and the resulting run-up on a plane smooth slope of $1:3\frac{1}{2}$ were examined. In presenting the measured results, the stagnation pressure of the wind was used as the independent variable. The measured dependent variables were the mean

wave period, length and height, and the run-up distributions. The water depth was 0.32 m.

In measuring the characteristics of the waves associated with a given wind speed and wave generating system, a wave damping structure was present at the downwind end of the channel. In this way the disturbing influence of reflection off the 1:3½ slope on the oncoming waves was eliminated as far as possible. The waves were produced either by wind alone or, to eliminate the drawback of a limited fetch (19 m), by a combination of wind and a wave board: "Waves produced with an infinitely large fetch, so-called equilibrium waves, are generated by adjusting the wave machine experimentally in such a way that under the influence of the wind the dimensions of the waves do not change" (Report M 101).

Measurements of these equilibrium waves showed the following relationship between run-up and dynamic pressure (see also Wassing, 1958):

$$z_{(2)} = 41\sqrt{s} \quad \left\{ \begin{array}{l} z \text{ in cm} \\ s \text{ in cm water column} \end{array} \right. \quad (\text{III.5.1})$$

or

$$z_{(2)} = 3.3 \bar{w} \quad z \text{ in cm, } \bar{w} \text{ in m/s,} \quad (\text{III.5.2})$$

in which \bar{w} is the wind speed calculated from the stagnation pressure s measured 43 cm above the mean water level.

A dimensional analysis of the problem of the run-up on a plane slope with gradient α , of equilibrium waves generated in water with a depth d , by wind of average speed w at a height y above the mean water level, gives

$$\frac{z}{d} = f\left(\frac{\bar{w}}{\sqrt{gd}}, \frac{y}{d}, \alpha, n\right) \quad (\text{III.5.3})$$

This relationship can be specified further if we assume that the wind speed increases with the distance above the water surface to the power 1/7. In this case \bar{w} and y only occur in the combination $\bar{w}y^{-1/7}$:

$$\frac{z}{d} = f\left\{\frac{\bar{w}}{\sqrt{gd}}\left(\frac{d}{y}\right)^{1/7}, \alpha, n\right\} \quad (\text{III.5.4})$$

Equation III.5.2 shows that $z_{(2)}$ is proportional to \bar{w} so that

$$\frac{z_{(2)}}{d} = \frac{\bar{w}}{\sqrt{gd}} \left(\frac{d}{y}\right)^{\frac{1}{7}} f(\alpha) \quad (\text{III.5.5})$$

From equation III.5.2 and the data $d = 0.32$ m and $y = 0.43$ m it follows finally that:

$$z_{(2)} = 0.19 \bar{w} \sqrt{\frac{d}{g}} \left(\frac{d}{y}\right)^{\frac{1}{7}} \quad \text{for } \tan \alpha = 1:3\frac{1}{2} \quad (\text{III.5.6})$$

This formula is equivalent to

$$z_{(2)} = 7.5 d^{\frac{9}{14}} s^{\frac{1}{2}} y^{-\frac{1}{7}} \quad (\text{III.5.7})$$

The above is a formalized version of the derivation given in report M 101 which led to the following expression, also quoted by Wassing:

$$z_{(2)} = 7 d^{\frac{2}{3}} s^{\frac{1}{2}} y^{-\frac{1}{7}} \quad (\text{III.5.8})$$

In equation III.5.8, which is not dimensionally homogeneous, all measurements must formally be quoted in cm. However, the coefficient 7 has the dimension $[L]^{-\frac{1}{42}}$; the small exponent means that only a minor error will be made if units other than cm are used.

The assumption that the waves are equilibrium waves is an essential feature of this approximation. The adjustment of the wave generator and the fetch of the wind must be introduced as additional parameters if this assumption is not applicable. The model waves described were not an identical imitation of equilibrium waves in natural conditions. It is not known to what extent the indicated run-up formulae are valid under natural conditions.

In the foregoing, run-up has been correlated with wind speed and water depth. An attempt can also be made to correlate run-up with the incident wave. In the case of the equilibrium waves described above, both the height and length were approximately proportional to the wind speed. The wave steepness was therefore practically constant (approx. 0.07) as was the relationship between run-up and wave height:

$$z_{(2)} = 2.1 \bar{H} \quad (\text{III.5.9})$$

For a comparison with wave run-up formulae it is desirable

to determine the values of the parameters $z_{(2)} \cot \alpha / \bar{H}$ and $z_{(2)} \cot \alpha / \sqrt{\bar{H} \bar{L}_0}$. These are indicated in table II.5.2 both for waves generated by wind alone and for equilibrium waves.

WAVE TYPE	\bar{w} (m/s)	\bar{H} (cm)	\bar{L}/\bar{H} -	$z_{(2)}$ (cm)	$\frac{z_{(2)} \cot \alpha}{\bar{H}}$	$\frac{z_{(2)} \cot \alpha}{\sqrt{\bar{H} \bar{L}_0}}$
WIND-GENERATED WAVE	5.7	3	8.6	4.4	5.14	1.75
„	7.6	4	9.7	6.4	5.60	1.80
„	9.8	5	11.0	9.0	6.30	1.90
„	11.4	6	12.5	11.5	6.70	1.90
EQUILIBRIUM WAVE	4.5 - 8.5	7 - 13	≈ 14	16 - 28	7.35	1.75 - 1.95

TABEL III.5.2

The value of $z_{(2)} \cot \alpha / \bar{H}$ varies considerably more than that of $z_{(2)} \cot \alpha / \sqrt{\bar{H} \bar{L}_0}$. The latter is identical to the $z'_{(2)}$ value defined by equation III.3.1. According to the hypothesis outlined in chapter III.3, its value is only dependent on the form of the joint distribution of H and L_0 . This is not known for the experiments concerned. It will simply be noted that the measured values fall within the range of 1.5 to 2.25 indicated in conclusion 4 in chapter III.3 (page 103).

In 1942 a series of experiments were carried out (M 202) to examine the influence of the slope gradient. The waves were generated by a combination of a wave machine and wind. Two wave heights of nominally 0.07 m and 0.10 m were used; they were designated low and high respectively. The period was practically constant, amounting to approx. 1 sec. The water depth was 0.35 m. The wave length was approx. 1.40 m so that the nominal wave steepness was 0.05 or 0.07.

Of two adjacent slopes, one with a gradient of $1:3\frac{1}{2}$ served as a reference while the gradient of the other was varied. The influence of the gradient alone was found by dividing $z(\alpha)$ by $z(\text{ref.})$ for each experiment. In this way variations in wave height etc. were eliminated. In figures III.5.6 and III.5.7, $z_{(50)}(\alpha) / z_{(50)}(\text{ref.})$ is plotted against $\tan \alpha$ and $\sin 2\alpha$ on a linear scale.

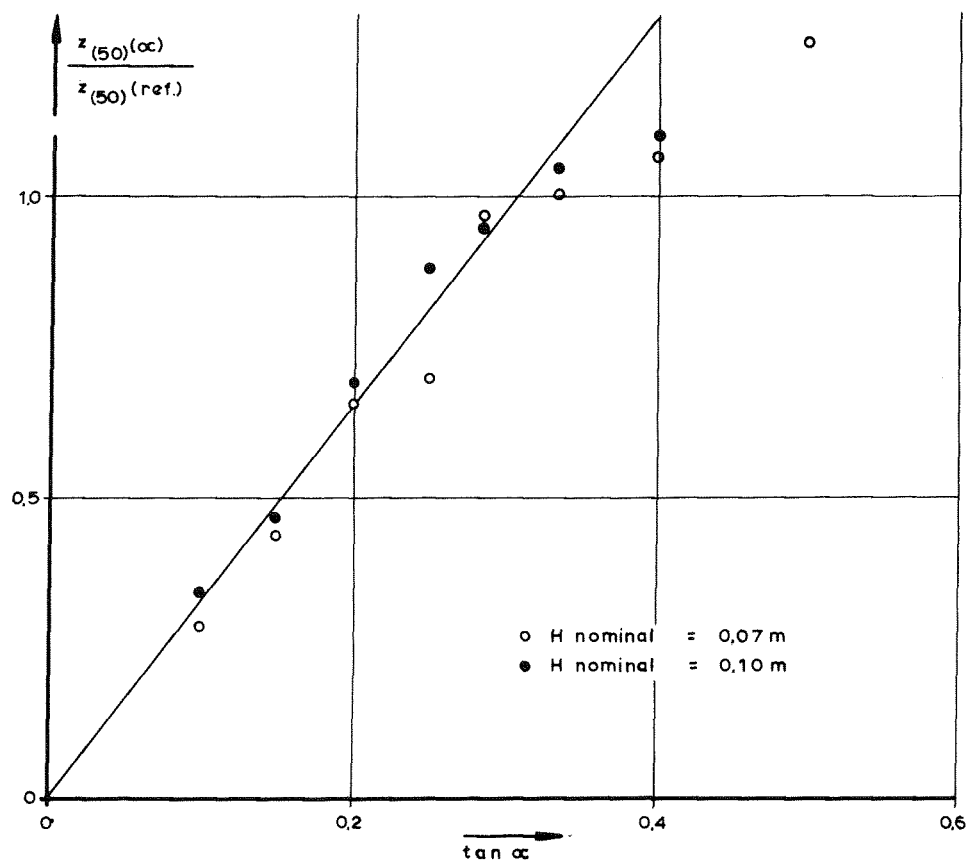

FIG. III. 5.6.

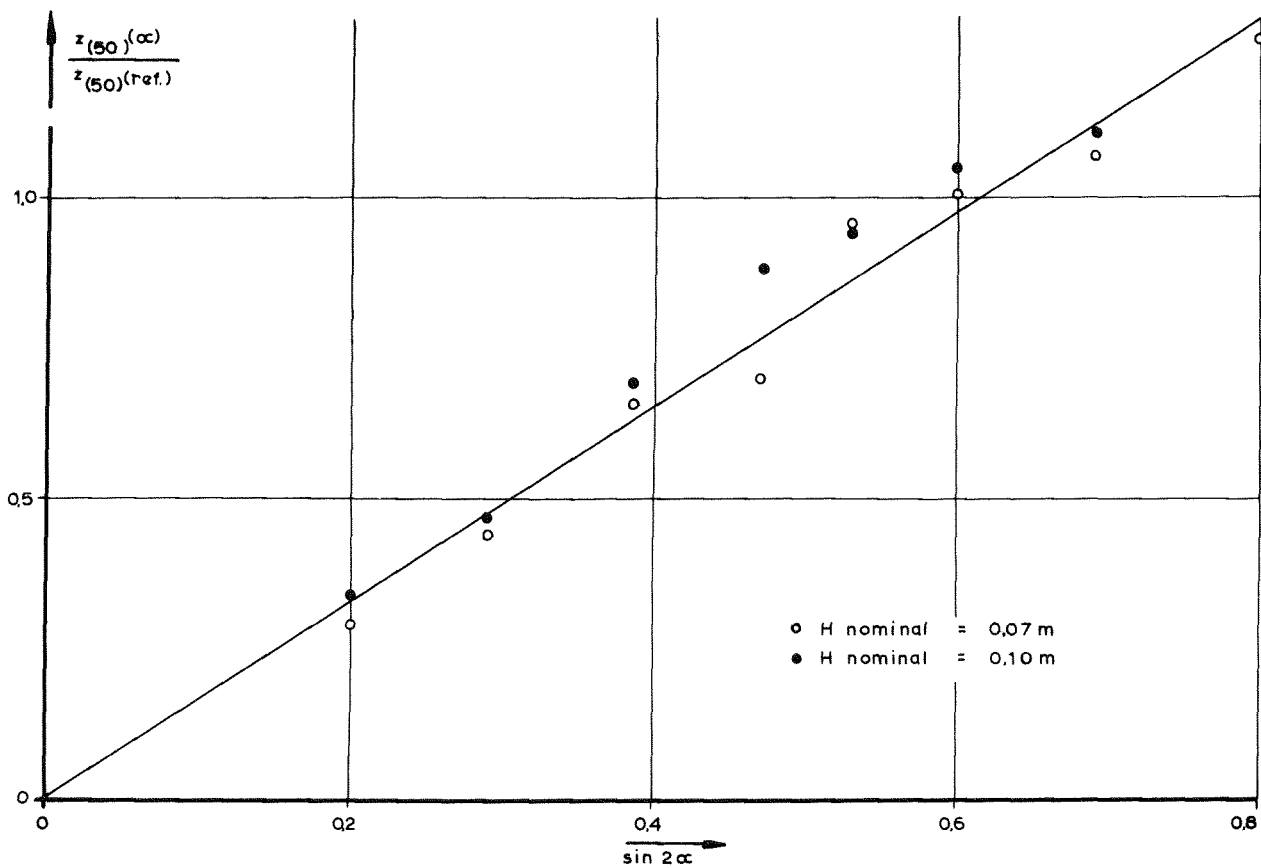

FIG. III. 5.7.

As indicated by Wassing (1958) the run-up for low slope gradients (up to $\tan \alpha \approx 1:3$) is proportional to both $\tan \alpha$ and $\sin 2\alpha$. These are then in a ratio of approx. 1:2 to each other. With steeper slopes, the run-up increases less rapidly than according to $\tan \alpha$ but remains approximately proportional to $\sin 2\alpha$ in the measurement range ($\tan \alpha \leq 1:2$). A formula in which z is proportional to $\sin 2\alpha$ therefore has a wider range of validity than one with $\tan \alpha$. Use of the latter has the advantage that it is closer to the normal manner of indicating the slope gradient. In addition, the more limited range of validity of a $\tan \alpha$ -formula is not a disadvantage in practice in the Netherlands, where there are practically no sea dikes with a slope gradient in excess of 1:3.

A relationship between wave run-up, wave height and slope gradient derived from the experimental results in M 202 is indicated by Wassing as

$$\left. \begin{aligned} z_{(2)} &= 7.5 \bar{H} \tan \alpha \quad \text{for } \bar{H}/L = 0.05 \\ z_{(2)} &= 7 \bar{H} \tan \alpha \quad \text{for } \bar{H}/L = 0.07 \end{aligned} \right\} 3.5 \leq \cot \alpha \leq 10 \quad \text{(III.5.10)}$$

(III.5.11)

Here \bar{H} is the average of the wave heights, "which did not vary greatly".

Because these expressions were used as one of the bases of a rather different run-up formula which has since become better known, it appears desirable to quote in full the reasons indicated by Wassing:

"Since the waves in the model were proportionally too steep (resulting in too small values of $z_{(2)}$), the difficulty arose how to transfer the model results to the prototype. After considering all the factors involved, it was decided to increase the factor 7.5 in the model to 8 in the prototype, for the 2% run-up on a dike with a stone revetment and waves of a steepness of 0.05. The run-up is thereby expressed in the "significant wave height" $H_{\frac{1}{3}}$. In this way the following formula was obtained:

$$z_{(2)} = 8 H_{\frac{1}{3}} \tan \alpha \quad \left(\text{for } \frac{H}{L} = 0.05 \right) \quad \text{(III.5.12)}$$

Quite apart from the question of the extent to which equations III.5.10 and III.5.11 are representative of the results of M 202 (considered on page 122), it is clear that the reasons indicated for the transition to equation III.5.12 are rather weak ¹⁾. No quantitative data were available on:

- the difference in stochastic nature of the waves in the model and prototype;
- the transition from \bar{H} to $H_{\frac{1}{3}}$, and
- the difference in roughness of the slope in the model and prototype.

Observations under natural conditions made during storms by the Zuiderzee Project Department gave some indications on the basis of which the factor 8 was finally chosen. These observations were, however, limited in number and inaccurate. For the validity of the resulting relationship a wave steepness of 0.05 is indicated (the steepness is not further specified) but there was some uncertainty as to the accuracy of the formula, even with this steepness. The formula was therefore merely provisional and indicative in nature¹⁾. In the meantime the formula itself has become more widely known in the Netherlands than the fact that it can only be considered valid for a wave steepness of approximately 0.05 and that even then its validity cannot be considered proven.

Perhaps unnecessarily, attention is drawn to the fact that the above observations do not imply or prove that equation III.5.12 is incorrect; it is simply indicated that the necessary evidence to the contrary is not available.

Uncertainty concerning the reliability of the run-up formula III.5.12 is not only due to the transfer of the model results to the prototype, as explained above, but also to the interpretation of the model results themselves, in particular with regard to wave heights. The nominal height of the low and high waves was 0.07 and 0.10 m respectively but it is not clear which height is referred to here. The consideration of the original data did not elucidate this fact. Both the exceedance percentage and the influence of reflection are unknown. Uncertainty concerning the measurements is also apparent from the fact that at a measurement point close to the slope the

¹⁾ The observations between ¹⁾ and ²⁾ are based on oral and written information given by Prof. J.Th. Thijsse and Mr. F. Wassing.

"high" wave is lower than the "low" wave in 4 out of 5 cases. From the data available at present, it is difficult to reach any conclusions on the absolute significance of the nominal wave heights of 0.07 m or 0.10 m respectively. It seems reasonable, however, to assume that the ratio of the wave heights in both cases was $10/7 = 1.43$.

As we shall see, the data in M 202 are suitable for a partial verification of the hypothesis introduced in chapter III.3. According to this hypothesis, the run-up distribution can be calculated by attributing to each individual wave in the wave train a run-up corresponding to Hunt's formula. In model M 202 the period was practically constant (waves generated by regular movement of a wave board and modified by wind) so that the proportionality between run-up and period cannot be verified. The assumed proportionality between run-up and $\tan \alpha$ has already been confirmed. It remains to be seen that the measured run-up distribution corresponds in terms of size and form with the distribution of \sqrt{H} . For this purpose it is first determined whether $z_{(50)}$ is proportional to $\sqrt{H_{\text{nom}}}$. The ratio of $\sqrt{H_{\text{nom}}}$ for the "high" waves to that of the "low" waves is $\sqrt{10/7} = 1.20$. According to the hypothesis to be tested this should also be the ratio between the corresponding values of $z_{(50)}$. These are indicated in column 4 of table III.5.3. They show a moderate dispersion around a mean of 1.20.

(1)	(2)	(3)	(4)
$\tan \alpha$	$z_{(50)}$ (cm) for		$\frac{(2)}{(3)}$
	$H_{\text{nominal}} = 0,10 \text{ m}$	$0,07 \text{ m}$	
0.1	4.7	3.7	1.27
0.15	6.9	5.7	1.21
0.2	9.3	8.1	1.15
0.25	11.8	9.3	1.27
0.286	15.4	13.4	1.15
0.333	15.8	13.2	1.20
0.4	17.5	15.4	1.14

TABLE III.5.3

The 50% run-up therefore proves to be approximately proportional to $\sqrt{H} \tan \alpha$. This will also be the case for run-up values with a different exceedance percentage if $z_{(n)}/z_{(50)}$ is equal to $\sqrt{H_{(n)}/H_{(50)}}$ for all n values. To test this, the wave height distribution measured at the measuring point situated closest to the slope at a distance of 4 m is used. The form of this distribution was not always the same from test to test with different α values. However, because the gradient angle should not influence the distribution of the waves, it is sensible to take the average over the different α values. These averages are shown in table III.5.4 together with the ratios of $z_{(n)}/z_{(50)}$ to $\sqrt{H_{(n)}/H_{(50)}}$ for different values of n. These ratios differ only by a few percent if at all from 1, both for low and high waves.

n (%)	$H_{nom} = 0.07 \text{ m}$			$H_{nom} = 0.10 \text{ m}$		
	$\frac{z_{(n)}}{z_{(50)}}$	$\frac{H_{(n)}}{H_{(50)}}$	$\frac{z_{(n)}/z_{(50)}}{\sqrt{H_{(n)}/H_{(50)}}}$	$\frac{z_{(n)}}{z_{(50)}}$	$\frac{H_{(n)}}{H_{(50)}}$	$\frac{z_{(n)}/z_{(50)}}{\sqrt{H_{(n)}/H_{(50)}}}$
50	1	1	1	1	1	1
40	1.04	1.09	1.00	1.06	1.11	1.01
30	1.08	1.18	1.00	1.12	1.26	1.00
20	1.13	1.30	0.99	1.19	1.41	1.00
10	1.20	1.46	0.99	1.29	1.58	1.03
5	1.27	1.60	1.00	1.37	1.77	1.03
2	1.33	1.71	1.02	1.46	1.96	1.04

TABLE III.5.4

From these data it is concluded that a reasonable approximation to the measured run-up distributions may be obtained by attributing to each individual wave a run-up proportional to $\sqrt{H} \tan \alpha$. The coefficient of proportionality, which was practically constant in the experiments, is generally a variable, as explained in chapter III.3. It is not possible to make any observations on the magnitude

of this parameter on the basis of the measurements in view of the reported uncertainties in the wave heights.

Greater significance is attached to the arguments which led to the above conclusions than to those which resulted in equations III.5.10 and III.5.11 because in the latter case only one point of the run-up distribution was used ($z_{(2)}$) in place of the entire measured distribution; moreover in a majority of cases this point was determined by extrapolation from the measured data.

In 1955 Sibul and Tickner carried out experiments to determine the run-up of wind-generated waves on plane slopes with gradients of 1:3 and 1:6 adjoining a foreshore with a gradient of 1:10. The transition between the foreshore and slope was situated at a depth of 4.5 cm, i.e. 1 to 2.5 times the $H_{\frac{1}{3}}$ value used. The maximum water depth in the model was 11 cm. The results are considered qualitative by Sibul and Tickner in view of the strongly exaggerated wind speeds. In addition, the dispersion is very great (sometimes a difference of more than 100% in run-up for the same \bar{w} and d values), and the measurements are influenced by reflection because the slope took up the whole width of the channel. The results are therefore not reproduced here.

In the context of studies preceding the design of the cross-section of the Veerse Gat dam, in the Netherlands, systematic measurements were made of the overtopping of wind-generated waves and regular waves over the crest of a dike with a smooth, plane slope (M 544, 1959; Paape, 1960). In addition to the quantity of overtopping, the percentage of overtopping waves was also determined. From these measurements, the following relationship was determined between $H_{(50)}$, α and h_d^* , the crest height at which 2% of the waves passed over the crest:

$$\frac{h_d^*}{H_{(50)}} = (20.5 \pm 2.5) (\tan \alpha)^{\frac{3}{2}} \quad \text{for} \quad \begin{array}{l} 3 \leq \cot \alpha \leq 8 \\ 0.034 \leq \frac{H_{(50)}}{L} \leq 0.062 \end{array} \quad (\text{III.5.13})$$

This value for h_d^* could be equated with the 2% run-up. This definition of run-up is, however, different from the definition of run-up where overtopping does not occur. By equating $z_{(n)}$ with the crest height at which $n\%$ of the waves overtop the crest, $z_{(n)}$ also becomes a function of the form and width of the dike crest, quite apart from the independent variables already referred to in chapter III.2. The

results of this procedure are therefore not directly comparable with the results of run-up measurements in which overtopping does not occur. The fact that h_d^* is proportional to $(\tan \alpha)^{\frac{3}{2}}$ need not then contradict the measurements showing that z is proportional to $\tan \alpha$. An evaluation of the relative merits of the two methods of determining wave run-up would fall outside the scope of this chapter.

Van Oorschot and d'Angremond (1968) measured the run-up of irregular waves produced by a programmed wave generator. By directing wind over the waves a shear stress was exerted on the water surface. The average wind speed did not exceed 3m/sec. In one case the waves were generated entirely by wind, with an average speed of approximately 8 m/ s. The slope was plane and smooth with a gradient of 1:4 or 1:6. The water depth was 0.40 m. The wave steepness $H_{\frac{1}{3}} / g\hat{T}^2$ was varied between the limits 3.9×10^{-3} and 12.2×10^{-3} . \hat{T} is defined as the period of the spectral component with maximum energy density.

In interpreting the measurements particular attention was given to the influence of the width of the spectrum, expressed in terms of ϵ . In calculating ϵ , the high frequency part of the spectrum was cut off from the point at which the energy density corresponded to 5% of the maximum. The experimental values for ϵ were between 0.22 to 0.59.

The measurements showed no influence of wave steepness and relative water depth on the form of the run-up distribution. However, the dispersion of the measured run-up values seemed to increase with increasing ϵ values. Expressed differently: a broader spectral energy density function of the waves results in a broader probability density function of the run-up values. An example of this is given in figure III.5.8 where a number of measured points are shown. The lower run-up values ($P > \text{approx. } 0.5$) are not reliable because of the measuring method used.

Van Oorschot and d'Angremond suggest the following formula for run-up by analogy with Hunt's formula:

$$z_{(n)} = C_{(n)}(\epsilon) \sqrt{H_{\frac{1}{3}} g \hat{T}^2} \tan \alpha \quad (\text{III.5.14})$$

The values for $C_{(2)}$ calculated from the measurements are plotted in figure III.5.9 against ϵ . The maximum dispersion (at constant ϵ) is approx. 15%. Apart from this, the measurements can therefore be seen as a confirmation of the validity of equation III.5.14.

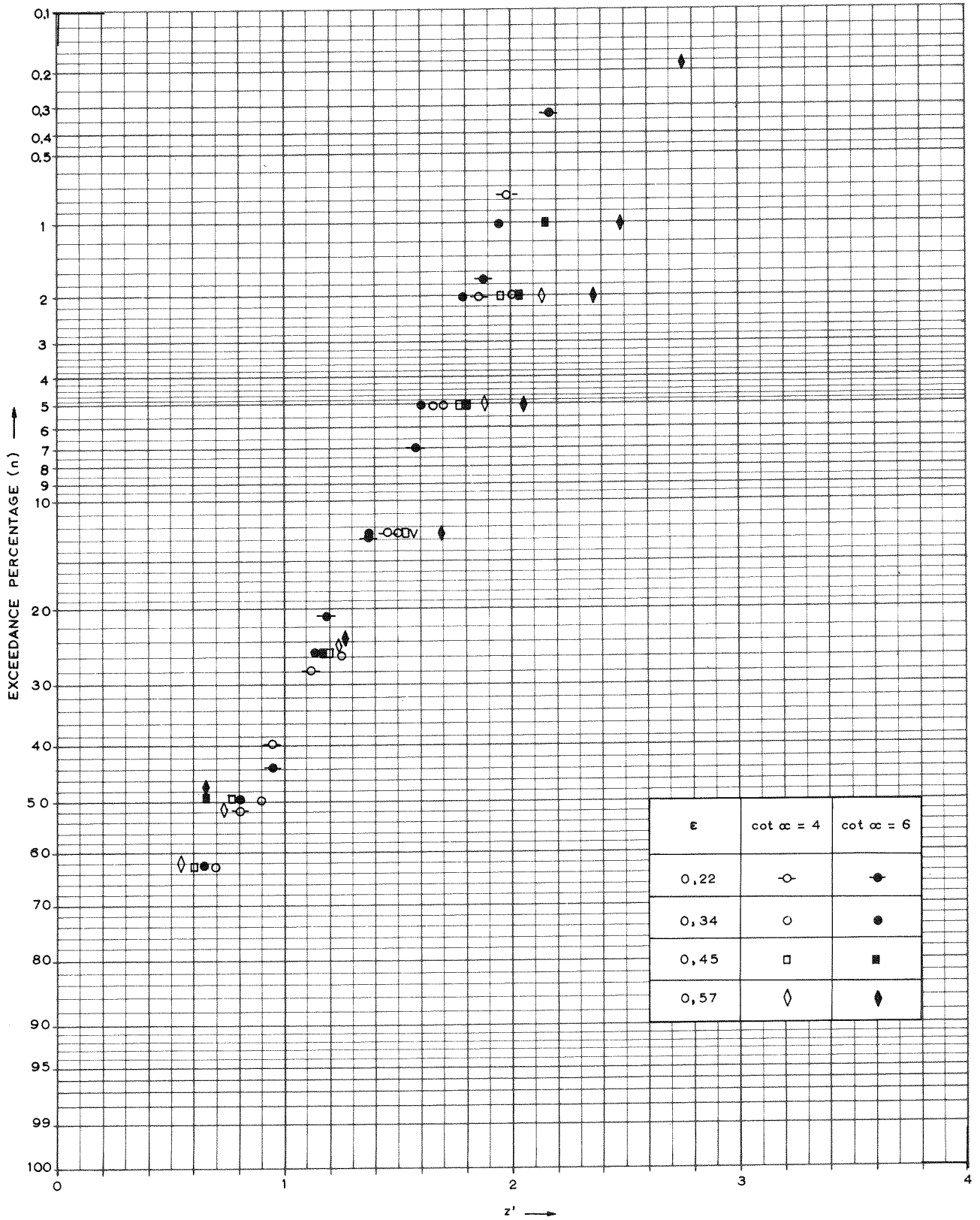

FIG. III . 5 . 8

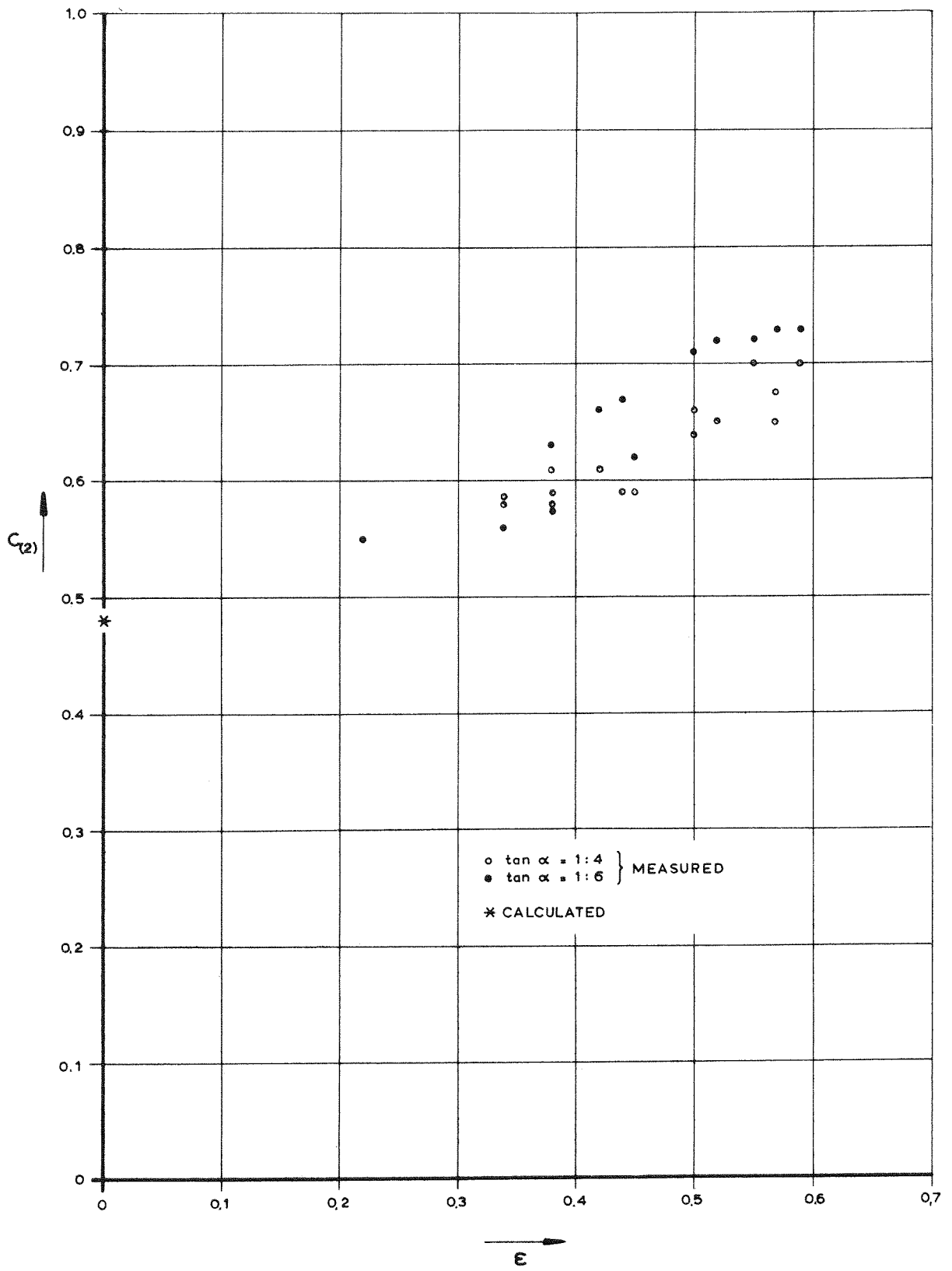

FIG. III 5.9.

Figure III.5.9 shows a clear tendency for $C_{(2)}$ to increase with ϵ . When interpreting and using equation III.5.14 it must not be forgotten that the C values shown in figure III.5.9 relate to 2% run-up. For smaller exceedance percentages, i.e. greater run-up, C increases more sharply with ϵ , and vice-versa. This is a consequence of the fact that a variation in ϵ leads far more to a different dispersion of the run-up values around the mean than to a change in the mean itself.

Van Oorschot and d'Angremond have applied Saville's hypothesis to two measurements, using the measured H-T distribution. There seems to be a good concordance with the measured run-up distributions, with maximum deviations of approximately 10%. These calculations have also shown that the influence of ϵ on the run-up distribution may be attributed to the influence of ϵ on the H-T distribution.

The conclusion that the run-up distribution is dependent on the H-T distribution coincides with the hypothesis indicated in chapter III.3 for calculation of the run-up distribution of breaking waves. According to these hypotheses

$$z_{(n)} = z'_{(n)} \sqrt{HL_0} \tan \alpha \quad (\text{III.5.15})$$

in which $z'_{(n)}$ is entirely determined by the joint distribution of H and T.

If the wave steepness is sufficiently low, the spectrum determines all the statistical characteristics of the wave pattern. The form of the H-T distribution is then only dependent on the form of the spectrum, and the same applies to the ratios $H_{\frac{1}{3}}/\bar{H}$ and \hat{T}^2/\bar{T}^2 . In this case equation III.3.1 may be converted to

$$z_{(n)} = f_{(n)} \left\{ \text{form of spectrum} \right\} \sqrt{H_{\frac{1}{3}} g \hat{T}^2} \tan \alpha \quad (\text{III.5.16})$$

If we also assume that the influence of the form of the spectrum is entirely determined by ϵ , then equation III.5.16 becomes equation III.5.14. However, there are spectrum forms where this does not apply, such as bimodal spectra.

It follows from the agreement between equations III.5.14 and III.5.15 that there must be a link between $z'_{(n)}$ and $C_{(n)}$. According

to the definitions

$$\frac{C_{(n)}}{z'_{(n)}} = \frac{z_{(n)}/\sqrt{gH^{1/3}\hat{T}^2 \tan\alpha}}{z_{(n)}/\sqrt{HL_0} \tan\alpha} = \frac{1}{\sqrt{2\pi}} \sqrt{\frac{H}{H^{1/3}}} \sqrt{\frac{\hat{T}^2}{\hat{T}^2}} \quad (\text{III.5.17})$$

For a very narrow spectrum ($\epsilon \rightarrow 0$) this becomes

$$\frac{C_{(n)}}{z'_{(n)}} = \frac{1}{\sqrt{2\pi}} \sqrt{0.63} \sqrt{\Gamma} = 0.32 \quad (\text{III.5.18})$$

If the spectrum is not very narrow, C/z' may assume other values than 0.32 but deviations will be small because $\sqrt{H/H^{1/3}} \cdot \sqrt{\hat{T}^2/\hat{T}^2}$ generally varies little with ϵ .

With the aid of equations III.5.18 and III.3.3, $C_{(2)}$ can be calculated if $\epsilon = 0$. In this case $z'_{(2)} = 1.5$ (conclusion 4, page 103) so that $C_{(2)} = 0.32 \times 1.50 = 0.48$. This value is shown in figure III.5.9; it appears compatible with the trend of the measured results. A comparison of the measured results given by Van Oorschot and d'Angremond with the distributions referred to in chapter III.3 for waves with $\rho = 0$ or $\rho = 1$, will be found in figure III.5.10. The measurement points cover approximately the whole calculated interval.

Webber and Bullock (1968) measured run-up on a plane, smooth slope with a gradient of 1:2, 1:4 or 1:10. The waves were generated by wind in water with a depth of 0.25 m in a channel with a length of 12 m. The results contain the forms of the measured distributions of wave heights and run-up heights. Both appeared to follow almost a Gaussian function. The measurements are, however, presented in a form which is not suitable for more detailed quantitative analysis.

III.5.4 Plane slope with roughness elements

As far as is known, studies of the influence of roughness elements on the run-up of wind-generated waves has only been carried out in the Netherlands. The first experiments of this nature were already conducted in 1939 (M 151). The data obtained in these and subsequent experiments are summarized in report M 544/1 (1957) and also by Wassing (1958). Some data are described below.

Research project M 151 concentrated on the effect of roughness elements. The measurements were taken in a wind flume with a water depth of 0.32 m. The stagnation pressure of the wind was 0.25 cm water column at 0.4 m above the water surface, corresponding to a

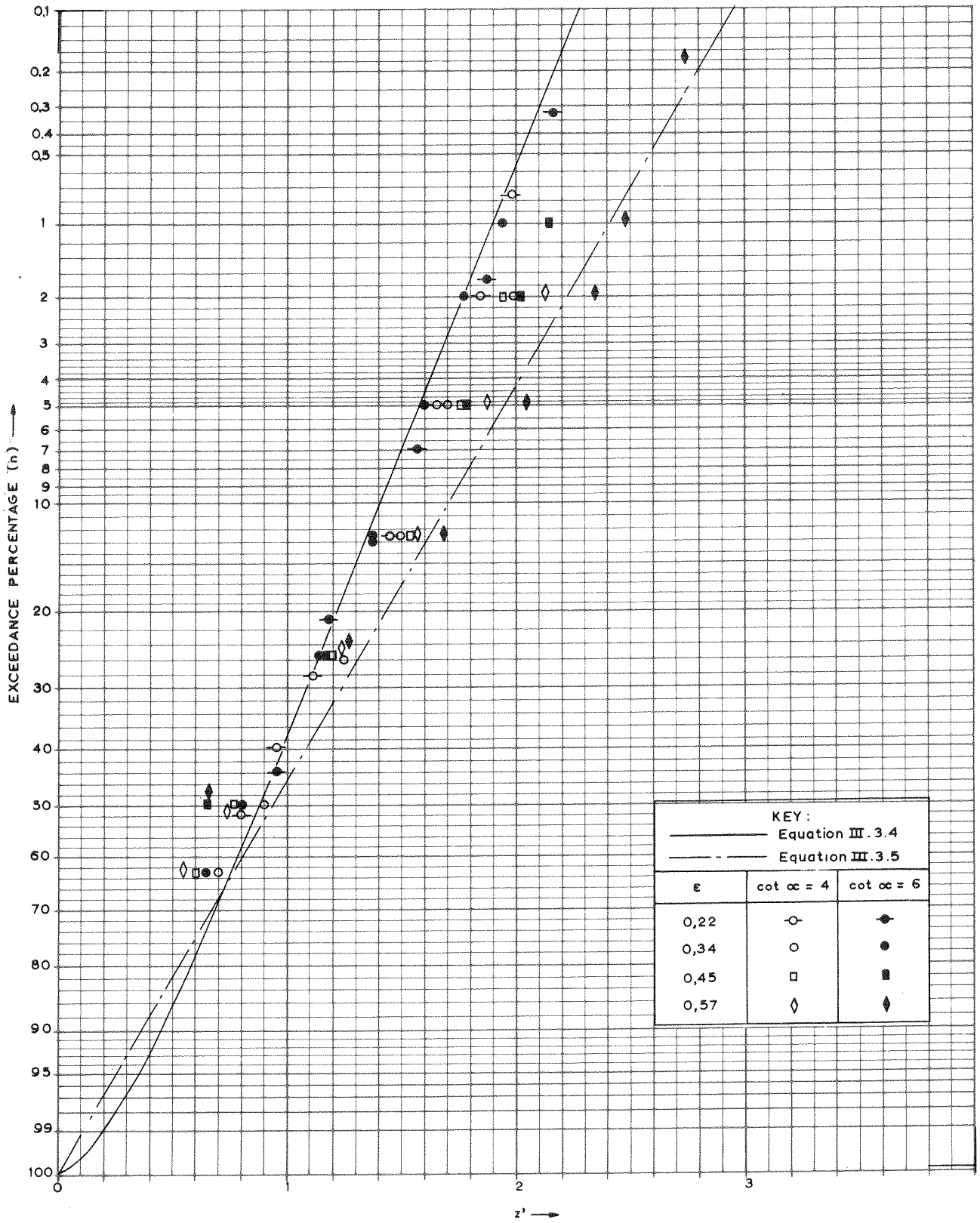

FIG. III . 5 . 10

velocity of 6.35 m/s. The corresponding mean wave height and length were 0.08 m and 1.30 m. The slope gradient was $1:3\frac{1}{2}$.

The effect of roughness is expressed in the factor r defined in section II.5.3. The r values indicated here relate to the 2% run-up.

In designing the roughness elements it was initially assumed that the elements should function optimally when the running up water was subject to the greatest possible resistance and the water flowing down to the least possible resistance. This led to elements with a triangular cross-section with its base in the plane of the slope, the seaward side perpendicular thereto or vertical, and the top horizontal. The simplest example of this is provided by the stepped slope (Leendertse system) shown in figure III.5.11. In the model the corresponding r value appeared to be approximately 0.8 both for $k = 0.9$ cm and for $k = 2.25$ cm.

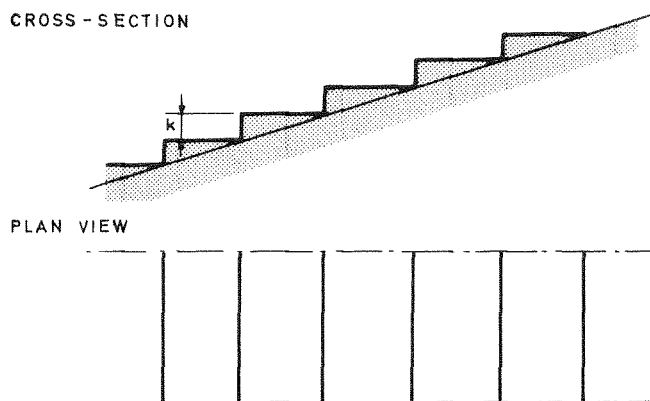

FIG. III.5.11

Studies have also been made of the effect of roughness elements with a similar cross-section but limited length, placed in a specific pattern on the slopes. The r values varied between 0.76 and 0.84.

Elements with a rectangular cross-section have also been studied. An r value of approximately 0.85 seemed to be appropriate for the block pattern indicated in fig. III.5.12.

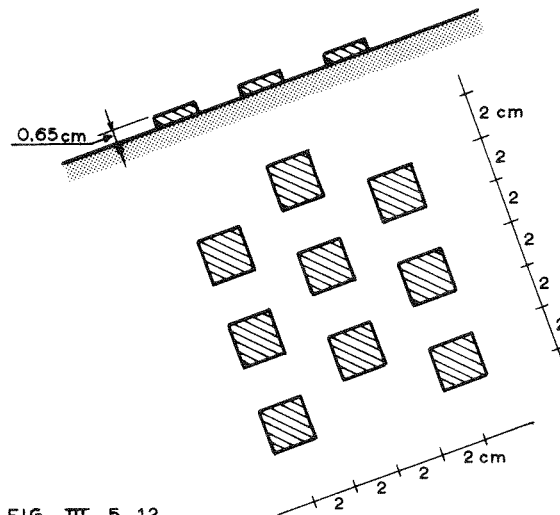

FIG. III. 5.12.

It was felt that a greater reduction might be obtained by providing traps on the slope. These did in fact give an improvement; the minimum r values were approx. 0.6. To achieve this result, however, a relatively large channel depth was needed. The large size of these traps and their complicated shape make them a very expensive solution.

The reduction obtainable by means of ribs is examined in model M 568 in which both regular and irregular waves are used. $H_{\frac{1}{3}}$ and \bar{T} for the irregular waves were equal to H and T for the regular waves. In regard to the results of the experiments with the irregular waves the report is very brief; only the ratios of the 2% run-up heights for irregular and regular waves are given. It is not, however, explicitly stated whether these ratios apply to the smooth slope, the rough slope or both. Presumably both are referred to. This would mean that the r value for ribs under irregular waves is the same as that for regular waves, i.e. a minimum of 0.5 to 0.6.

A number of measurements have also been made of the reduction in run-up caused by rows of piles. An example is quoted in M 544/1 where $r \approx 0.80$ to 0.85.

Section II.5.3 contains a number of observations of a qualitative nature concerning the effect of roughness elements. These observations are also considered applicable in the case of irregular waves. Because of the lack of comparative material, it is not known to what extent this is permissible for the quantitative results.

III.5.5 Rough and permeable slope

Very little quantitative data are available on the run-up of irregular waves and slopes with natural roughness and permeability.

For basalt and block coverings an r value of 0.85 to 0.90 is indicated for the 2% run-up (M 544/1). From certain unpublished measurements by the Delft Hydraulics Laboratory of run-up on a plane rubble slope, an r value of 0.5 to 0.6 may be derived.

The above values coincide with those for regular waves. It is not known to what extent this also holds good for other types of slope covering.

III.5.6 Non-plane, smooth slope

Over the years a considerable number of model studies have been made with a view to determining the run-up of irregular waves on non-plane slopes. Most have concentrated on specific instances so that the results cannot easily be generalized quantitatively. The influence of berms has, however, been studied in a general sense and the results are discussed below.

In project M 101 measurements were taken on a slope with gradient $1:3\frac{1}{2}$ with a berm. The wave characteristics were the same as in table III.5.2 (page 118).

Berms of different widths were used, with d_B , i.e. the berm depth below the mean water level, corresponding to 6.5 cm, 3.0 cm, -0.6 cm, -4.3 cm or -8.0 cm. In most instances the reduction was greatest for $d_B = 3.0$ cm or $d_B = -0.6$ cm. It was therefore concluded that a berm is most effective if it is situated approximately at the mean water level. In the following paragraphs we shall only consider the experiments in which $d_B = 3.0$ cm or -0.6 cm.

The berm width was 16 cm, 32 cm or 48 cm in the experiments with pure wind-generated waves and 32 cm, 48 cm or 64 cm in the experiments with the (longer and higher) equilibrium waves. Since in addition the wave dimensions were varied for a constant berm width,

an impression was obtained of the influence of the relative berm width on the wave run-up reduction.

In report M 101 the berm width is expressed in terms of wave length. In the text both the value of B/\bar{L} and that of the corresponding reduction are indicated for a small number of cases. These appear approximately identical up to a value of approx. 0.3. At greater relative berm width, the reduction increases less rapidly than the value of B/\bar{L} . These observations are probably the basis for the formula introduced subsequently.

$$r = 1 - \frac{B}{L} \quad \text{for } \frac{B}{L} < \text{approx. } 0.3 \quad (\text{III.5.19})$$

To show the relationship between r and B/\bar{L} more clearly, they are plotted against each other in figure III.5.13 (solid circles). The r value again relates to 2% run-up. As already indicated, report M 101 compares the run-up reduction with B/\bar{L} for a small number of points only. There is, however, no priori reason why all the measurement points should not be included in this comparison. Figure III.5.13 therefore also shows the other measured results in project M 101, with the proviso that $d_B = 3.0$ cm or -0.6 cm (open circles). For the solid circles there is clearer evidence of a linear relationship between r and B/\bar{L} than for the others, even if we only consider the points in the interval $0 < B/\bar{L} < 0.4$.

The berm width has so far been expressed in terms of wave length. Since the wave steepness varied somewhat in the experiments it is desirable to consider the relationship between r and B/\bar{H} or, for instance, between r and B/\sqrt{HL}_0 . This relationship is shown in figures III.5.14 and III.5.15. The dispersion is lowest in figure III.5.15 where r is plotted against B/\sqrt{HL}_0 , although this does not differ greatly from the dispersion in the two other figures. Be that as it may, it is clear that these data provide no evidence to support the choice of B/\bar{L} as an independent variable.

The influence of the berm on the 2% run-up was investigated above. It is, however, sensible to consider the effect of a berm on the shape of the run-up distribution as well. It may be expected that the elevation of the berm will play an important part in this.

If the berm is situated at approximately mean water level, all run-ups will be influenced by the berm but not to an identical extent.

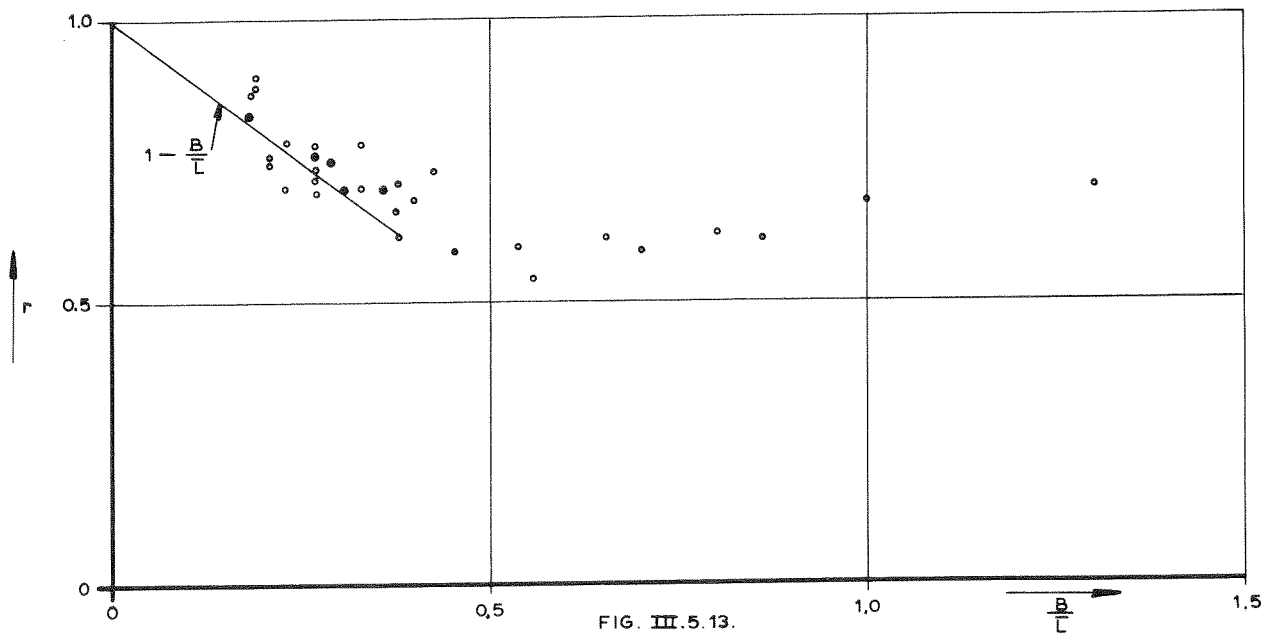

FIG. III. 5.13.

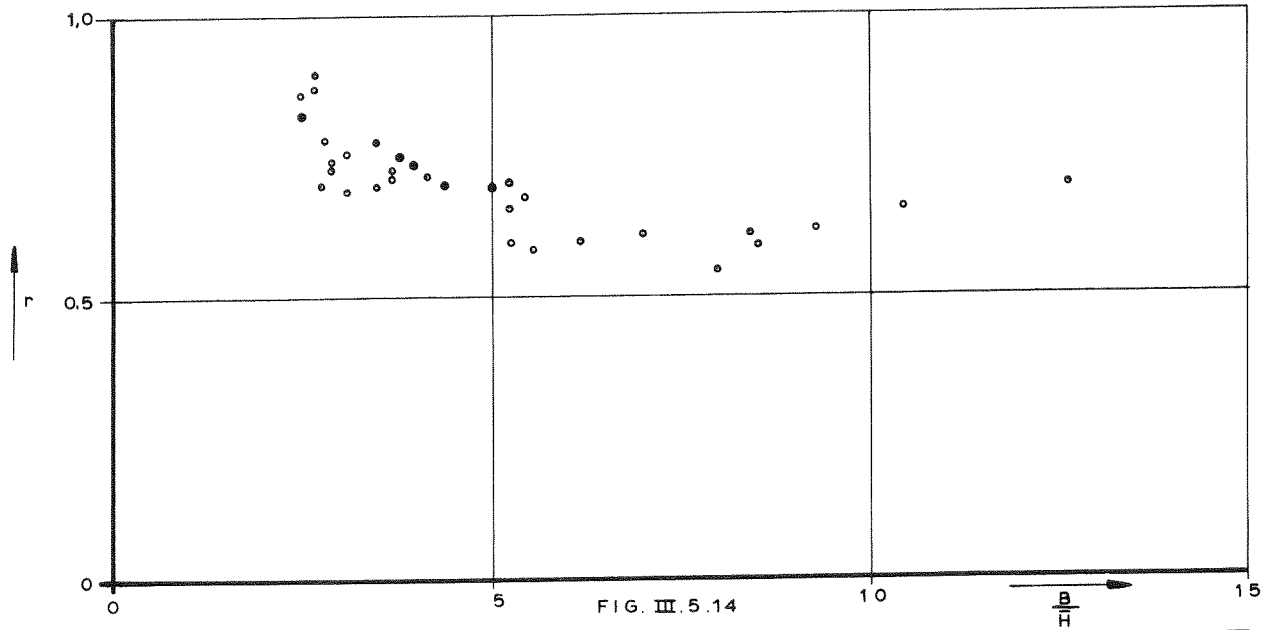

FIG. III. 5.14

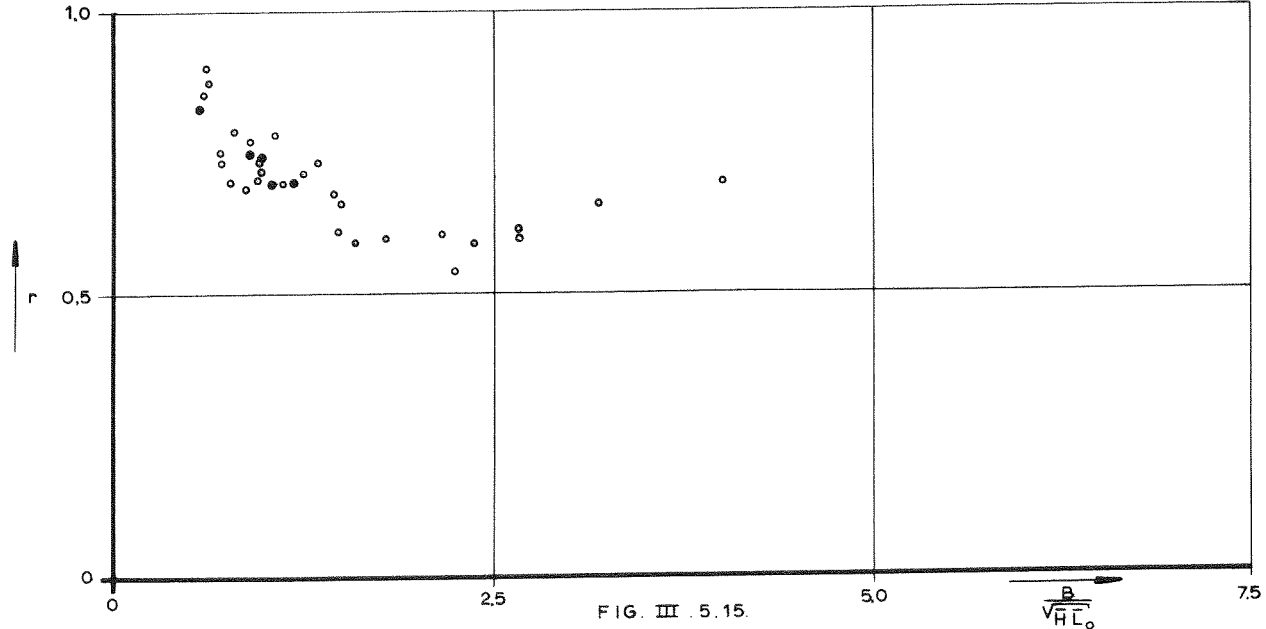

FIG. III. 5.15.

The berm has a greater effect on smaller waves than on larger ones so that it may be expected that run-up of the smaller waves will be reduced the most. In this way the distribution will become wider and show a greater dispersion.

If the berm is not located at mean water level, its width will still be greater in relation to the small waves than to the large ones, which will tend to result in greater reduction but it will also be at a relatively deeper or higher level, which will have precisely the opposite effect. This is particularly clear in the case of a berm situated at a high level, because the smaller run-ups will not even reach the berm in this instance.

In order to quantify this effect the value has been determined from the measurements in project M 101 of the expression

$$x = \frac{[z(2)/z(50)]_B}{[z(2)/z(50)]_{B=0}} \quad (\text{III.5.20})$$

$x < 1$ indicates a narrower distribution (less dispersion) and $x > 1$ a broader distribution (more dispersion) than for a plane slope. For the tests in which the berm was situated only just above the mean water level, if at all, ($d_B = 6.5$ cm, 3.0 cm or -0.6 cm), x varied from approx. 0.8 to approx. 1.2 in a non-systematic manner. For the experiments with a high-lying berm ($d_B = -4.3$ cm or -8.0 cm) x was generally smaller than 1 with a minimum of 0.65 . This observation corresponds qualitatively with the anticipated results.

In the above-mentioned measurements in project M 101 the berm was horizontal and the upper and lower sections at the same gradient ($1:3\frac{1}{2}$). A number of measurements were carried out with different shapes and a nominal berm width of 64 cm. The variants studied are shown in figure III.5.16. The corresponding r values are also shown in the figure. This indicates that the provision of a cap (b) brings about a slight improvement. A berm gradient of $1:7$ (c) seems unfavourable: the reduction is only half that for a horizontal berm. The steeper upper section (d) also suggests a greater r value.

In the model study M 277 (1946) relating to the Westkapelse Seadike, the effect of a smooth transition between the berm and the upper section was studied. In general the run-up was increased slightly and the intensity of the wave impact on the upper section reduced.

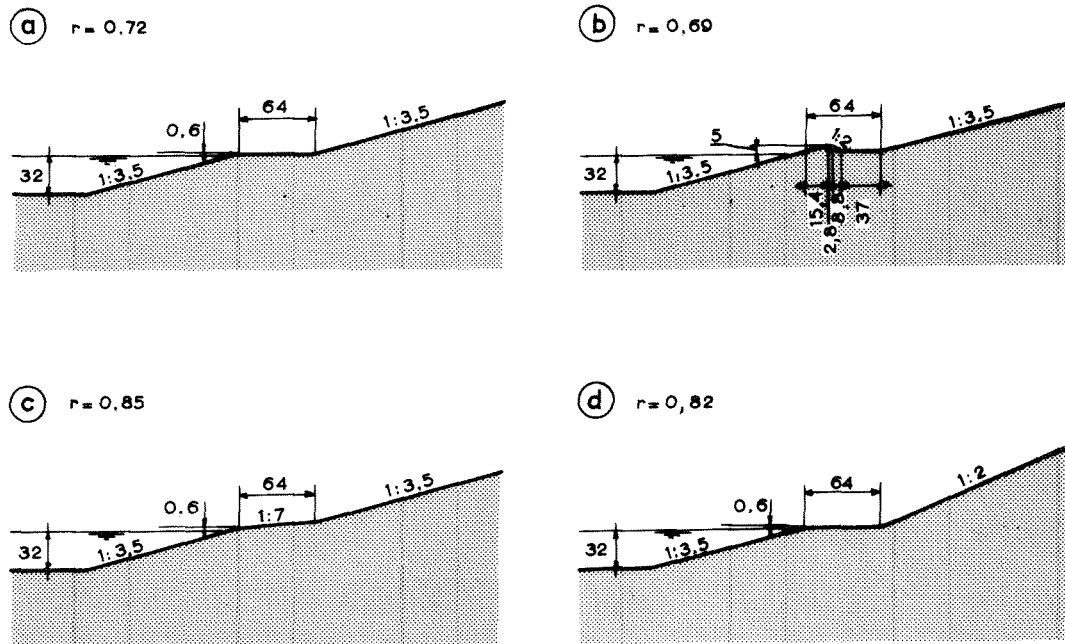

FIG. III.5.16

III.5.7 Oblique incidence

The influence of the direction of incidence of the waves on run-up was examined in model project M 101. The wind channel used had a width of 4 m. The angle of incidence β was varied by placing the slope obliquely in the channel; the β values considered were 0° (perpendicular incidence), 30° , 45° , 52° and 60° . In order to counteract undesirable reflection effects, the slope facing the acute angle between the outer slope and the channel wall was made of netting, up to a distance of 1.5 m perpendicular from the channel wall. The measurements were carried out with equilibrium waves (see table III.5.2) running up against the plane slope or against the slope with a 32 cm wide berm situated 0.6 cm above the mean water level.

Before presenting the results of these tests, the test set-up described above will be considered.

Disturbances are introduced at the end of the slope. Diffraction occurs in the vicinity of the transition between the closed and open (netting) slope sections; under the given conditions, the relative order of magnitude of the disturbance introduced in this way is estimated at $0.1 \sqrt{L/R}$ at points at a distance of $R \gg$ approx. $0.5 L$ from the transition. In order to eliminate sufficiently the effect of these interfering factors on the measured result, the measuring line must therefore be set back from the ends by a minimum number of wave lengths. Considered in this way, the test slope used is on the short side; the length is e.g. only approx. $1.5 \bar{L}$ at $\beta = 30^\circ$ and $\bar{L} = 1.8$ m. It would have been interesting to carry out tests also with a partially open slope as well as a completely closed slope under perpendicular wave incidence. This would have given an impression of the extent of the disturbance introduced in this way.

In addition to the finite length of the test section, reflection may also have an undesirable influence, at least in so far as the (primary) incident waves, after reflection against the slope, are re-reflected at some other point in the flume and then impinge on the test slope once more. This problem often plays a part in two-dimensional studies in wave channels when the waves are reflected off the wave generator. In this case it is, however, of more than usual significance because reflection already occurs against the channel wall close to the slope on account of its oblique situation. An angle of about 45° seems particularly unfavourable in this respect. This perhaps explains why the run-up with $\beta = 45^\circ$ appeared equally large as with $\beta = 0^\circ$ (perpendicular incidence) and even greater than with $\beta = 30^\circ$.

On the basis of the above considerations it is concluded that the test arrangement used was not particularly suitable to measure the influence of oblique incidence on wave run-up. The results referred to below must therefore be treated with the necessary degree of caution.

On the plane slope the reduction in relation to perpendicular incidence was only about 10% for $\beta < 45^\circ$. In report M 101 it is stated that for $\beta > 45^\circ$ the nature of the phenomenon changes: "The waves run up less against the dike but sweep along it and the crests do not reach a great height. The change occurs particularly when β

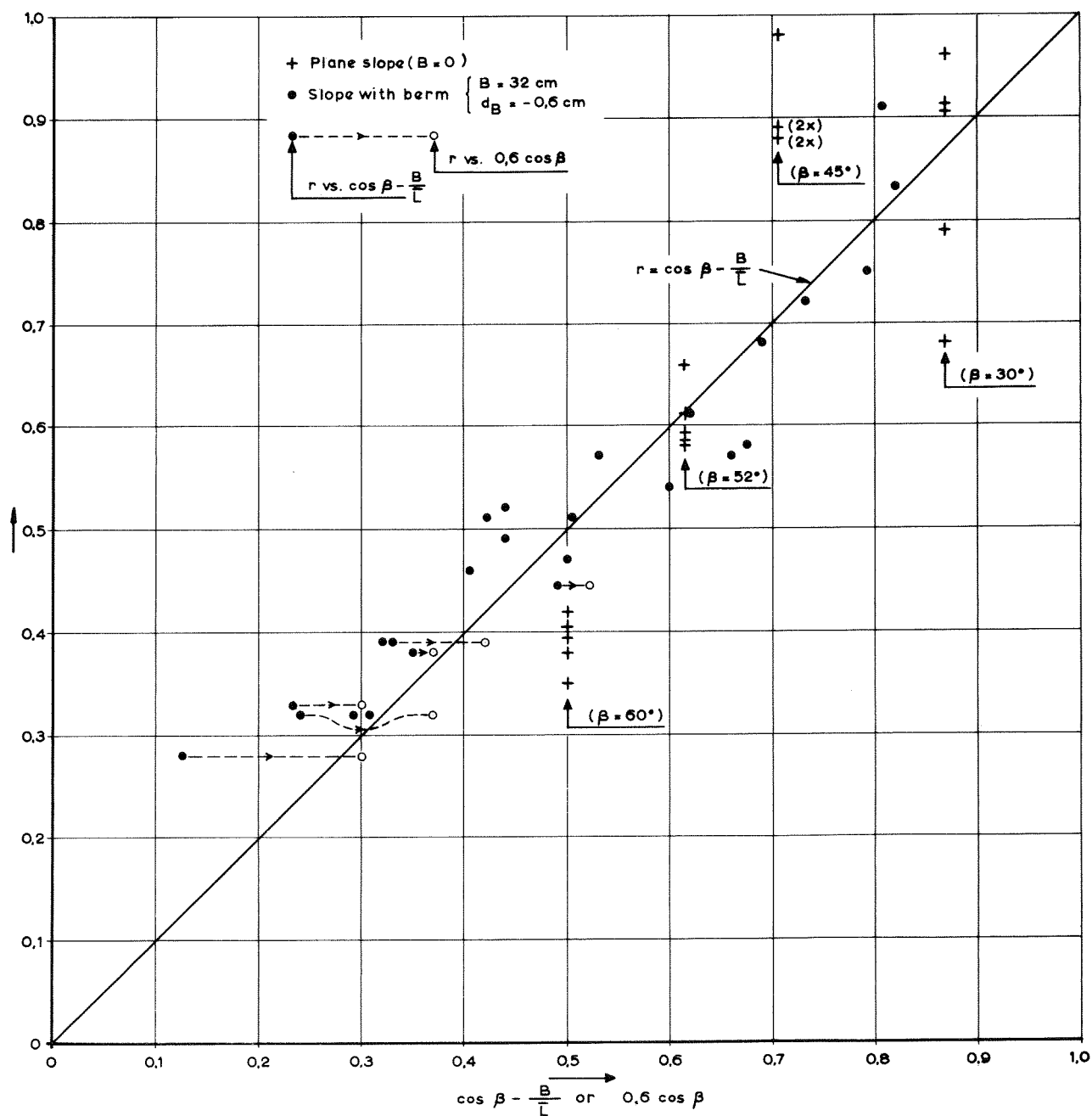

FIG. III . 5.17

increases from 45° to 60° and the wave run-up is then reduced to less than one half of the original value".

The influence of oblique incidence on the value of $z_{(2)}$ is often taken into account by multiplying by a factor $\cos \beta$. The measured r values for a plane slope ($B = 0$) are therefore plotted in figure III.5.17 against $\cos \beta$. Only with $\beta = 52^\circ$ is there a concordance between the two values.

On the slope with a berm there was a considerable reduction in run-up for $\beta = 30^\circ$ and 45° , in contrast to what was observed for the plane slope. This may be attributed to the increase in the apparent berm width in the wave propagation direction, i.e. of $B / \cos \beta$, the greater the angle of incidence of the waves becomes. If the effect of a berm under perpendicular incidence were expressed by $(1-B/\bar{L})$, the effect of a berm under oblique incidence could be expressed by $(1-B/\bar{L} \cos \beta)$. If in addition the influence of the reduction in the apparent slope gradient is taken into account by multiplying with $\cos \beta$, we arrive at the factor $(\cos \beta - B/\bar{L})$ which is often used. The values for this are plotted in figure III.5.17 against the measured r values. There appears to be a good agreement between these values, much better than between r and $\cos \beta$ for $B = 0$ and also better than between r and $(1-B/\bar{L})$ for $\beta = 0^\circ$ (figure III.5.13). It is not known to what extent this is fortuitous.

In connection with the question as to the accuracy of the factor $(\cos \beta - B/\bar{L})$ reference is also made to the observation in section III.5.6 that it is not clear that berm width should be expressed in wave length. This is particularly true for the results shown in figure III.5.17 since in this case the wave steepness was constant ($1/14$). A factor $(\cos \beta - B/14 \bar{H})$, or more generally $\{\cos \beta - (B/\bar{L})f(\bar{H}/\bar{L})\}$, where the function f corresponds to $f(1/14) = 1$ but is completely arbitrary in other respects, would also coincide well with the measurements. It must not be forgotten, either, that r does not reduce to an unlimited extent with increasing relative berm width; the minimum r value is approximately 0.6 (see figure III.5.13). Under oblique incidence and in the presence of a berm this would imply that r could not fall below approx. $0.6 \cos \beta$. This correction has been made in figure III.5.17. Six points are shifted over to the right as a result, generally closer to the line of complete agreement between the formula and measured values.

III.5.8 Wind influence

As indicated in section III.4.9, the wind influences run-up through the mean water level and the oncoming waves as well as through its direct effect on the mass of water running up the slope. In this section, only the latter effect will be considered. Various efforts have been made to study this influence in a model.

One aim of the experiments conducted by Sibul and Tickner (1955), referred to in III.5.3 above, was to determine the effect of wind on wave run-up. For the reasons indicated at that point no further attention will be given to these experiments.

Report M 544/1 of the Delft Hydraulics Laboratory (1957) gives some data for the influence of wind on wave run-up. In the experiments to which reference is made, the wind speed was 0 m/sec, 3.3 m/sec, 9 m/sec and 12 m/sec respectively at 0.2 m above the mean water level. Only one wave height, period and length is referred to. This probably relates to the waves produced by the wave generator. No data are reported on the influence of wind on waves. On the basis of the information referred to above, it is therefore impossible to draw any conclusion as to wind influence on run-up.

In subsequent experiments in the Delft Hydraulics Laboratory (M 872, 1968) both the run-up heights and various wave characteristics were measured at different wind speeds \bar{w} varying from 0 m/sec to 17 m/sec at a height of 0.4 m above the mean water level. A number of combinations of wave generator adjustment (regular), water depth (0.5 m and 0.8 m) and slope gradient (1:3, 1:4, 1:8) were used. To limit the influence of wind on the oncoming waves, the slope was placed at only a few metres from the wave generator. Despite this precaution, the wave height increased significantly as the wind speed rose. An attempt can be made to eliminate this effect by normalizing run-up e.g. with the aid of equation III.5.14. In the case in point the period was practically constant and $\epsilon \approx 0$ so that \hat{T} may be equated to the period T of the wave generator. In addition $H_{(15)}$ was used instead of $H_{\frac{1}{3}}$. If the wave heights follow a Rayleigh distribution these two parameters will be practically identical. Making these substitutions, equation III.5.14 becomes

$$C_{(n)} = \frac{z_{(n)}}{T \sqrt{gH_{(15)}} \tan \alpha} \quad (\text{III.5.21})$$

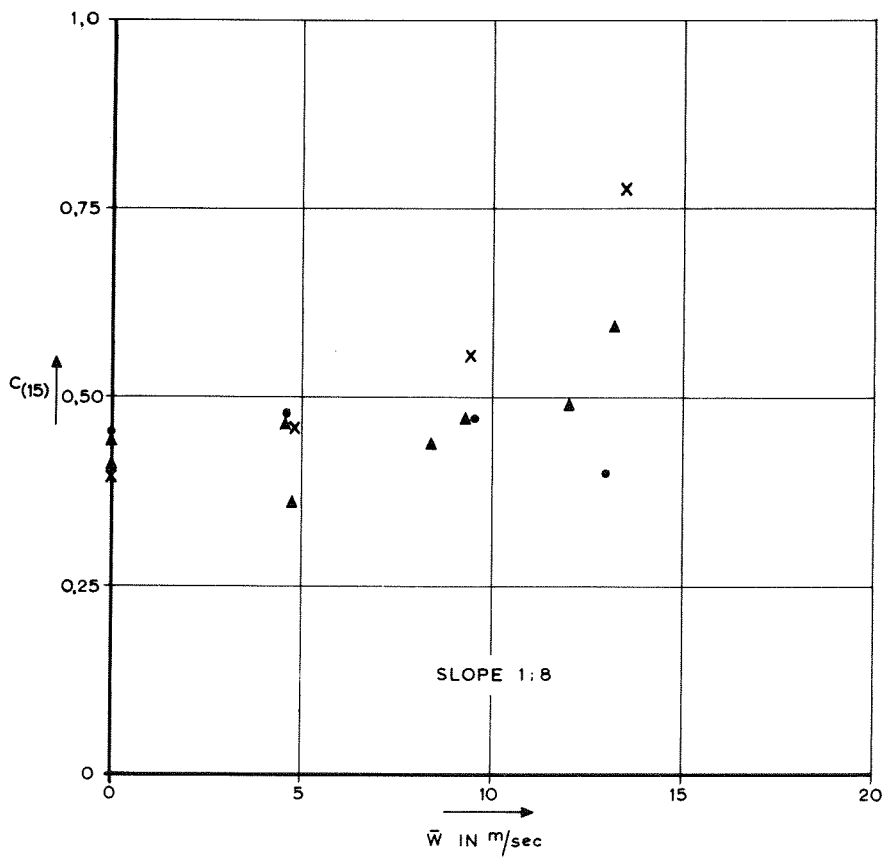
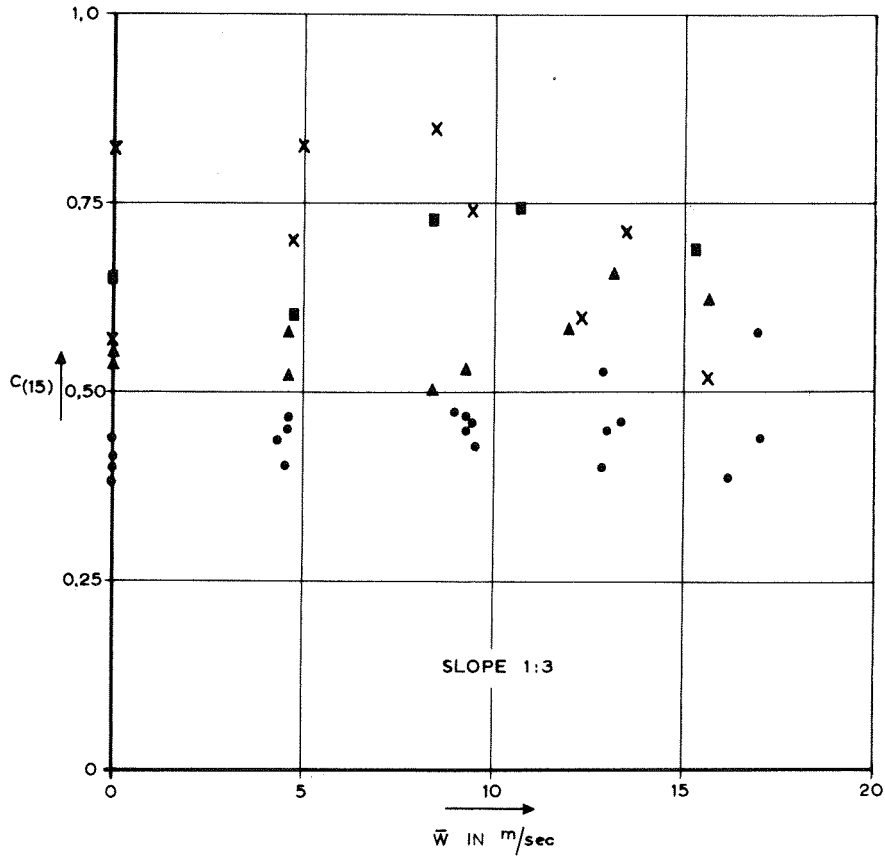

- X Period 0,7 sec
- ▲ Period 1,1 sec
- Period 1,42 sec
- Period 1,8 sec

FIG. III.5.18

In order to investigate the wind influence on wave run-up, $C_{(1)}$ and $C_{(15)}$ have been plotted against \bar{w} with constant d , α and wave generator setting. Of the resulting graphs, figure III.5.18 shows those which relate to $C_{(15)}$ for slope gradients of 1:3 and 1:8. These are representative of the entire group since $C_{(1)}$ has the same characteristics as $C_{(15)}$ and because in both cases the results for a slope gradient of 1:4 do not differ significantly from those for a slope gradient of 1:3. In the majority of the experiments, the difference between $C_{(1)}$ and $C_{(15)}$ was relatively small and practically unaffected by \bar{w} . The following conclusions may be drawn from these data:

- 1) For constant T and α values, the variation of C with \bar{w} is greater the smaller the value of T . For the highest T value (1.8 sec) C is practically constant. In this connection it should be noted that the wave heights have been varied as a function of the period in such a way that $H_{(15)}$ increased with T . A statistical relationship with T therefore definitely does not imply a causal relationship.
- 2) For a slope gradient 1:3 no trend of C with \bar{w} can be noted but with that of 1:8 there is a slight increase in C with \bar{w} .
- 3) For the slope gradient 1:3 the variation of C with T is practically independent of \bar{w} .
- 4) The high wind speeds used in the model may be said to be exaggerated if it is assumed that Froude's scale law must be complied with for true-to-scale representation of wind influence on run-up. This is apparent from a comparison of the model values of \bar{w} (max. approx. 17 m/sec) and $H_{(15)}$ (approx. 0.05 m with $T = 0.7$ sec to approx. 0.25 m with $T = 1.8$ sec) with the respective values in the prototype, under conditions in which it is interesting to know the wind influence on run-up. Viewed in this way wind speeds of more than 5 m/sec in the model must practically always be considered exaggerated. In the range $\bar{w} = 0$ m/sec to $\bar{w} = 5$ m/sec no trend of C with \bar{w} will be noted in these measurements.

An attempt may be made to determine the influence of wind by calculation as well as by tests. An estimate is given below of the order of magnitude of this influence. For this purpose the equilibrium of a section of running up water is considered. The forces acting on the latter in the direction parallel to the slope result from:

- wind (a)
 gravity (b)
 resistance (c)
 pressure gradients (d)

The relative influence of the wind is equated to the ratio between wind force and the sum of the other forces. It is assumed that the resistance and pressure force are negligible in relation to the weight component. This leads to an overestimate and an under-estimate of the wind influence, respectively.

- a) Let us assume that the wind force per unit of surface area is equal to $C \rho_a \bar{w}^2$. The coefficient C is a function of a Froude number based on \bar{w} and the height y above the water surface at which \bar{w} is measured. For $\bar{w} = 15$ m/sec and $y = 0.4$ m, $C \approx 4 \times 10^{-3}$ (Wu, 1970).
- b) Let us assume that the height of the section is KH in which H is the height of the oncoming wave and K a coefficient with a representative value between 0.05 and 0.1. The component parallel to the slope of the weight per unit area is

$$\rho g K H \sin \alpha$$

The relative wind influence is then

$$\frac{C}{K} \frac{\rho_a}{\rho} \frac{\bar{w}^2}{gH} \frac{1}{\sin \alpha}$$

or, substituting the numerical values,

$$(5 \text{ to } 10) 10^{-5} \frac{\bar{w}^2}{gH \sin \alpha}$$

In the experiments referred to \bar{w}^2/gH (15) amounted to a maximum of 230 (!) and $\sin \alpha$ to a minimum of 0.12 so that the upper limit of the above ratio was approximately 0.18.

The experiments discussed above and the estimate described indicate that the direct wind influence is not very significant on run-up. Comparative experiments would be necessary to obtain greater certainty in this respect, with the wind acting on the running up water in one instance and not in the other, while in both cases the oncoming waves would be exposed in an identical manner to wind.

III.6 REFERENCES

- Battjes, J.A.: "Run-up distributions of waves breaking on slopes", Proc. ASCE, 97 Nr.WW1, p. 91-114, February 1971.
- Bretschneider, C.L.: "Wave variability and wave spectra for wind-generated gravity waves", Techn. Mem.no. 118, B.E.B., 1959, 192 pages.
- Carstens, T., Tørum, A. and Traeteberg, A.: "The stability of rubble mound breakwaters against irregular waves", Proc. 10th Conf. Coastal Eng., Tokyo, Part II, p. 958-971, 1966.
- Delft Hydraulics Laboratory, Report M 101: "Verslag van metingen over golfoploop" ("Report on run-up measurements"), 1941 (in Dutch).
- Delft Hydraulics Laboratory, Report M 151: "Proeven over den invloed van de geaardheid van de dijkbekleding op den golfoploop" ("Effect of slope facing on wave run-up"), 1941 (in Dutch).
- Delft Hydraulics Laboratory, Report M 169: "Onderzoek van het systeem Streefkerk voor de verdediging van een dijkbeloop" ("Investigation of system "Streefkerk" for the protection of a dike slope"), 1939 (in Dutch).
- Delft Hydraulics Laboratory, Report M 277: "Verslag onderzoek golfaanval op de Westkapelsche Zeewering" ("Report of investigation of wave attack on Westkapelle sea dike"), 1946 (in Dutch).
- Delft Hydraulics Laboratory, Report M 422: "Golfoploop Tuimeldijk", 1953 (in Dutch).
- Delft Hydraulics Laboratory, Report M 500: "Golfoploop Dijk Markerwaard" ("Wave run-up on "Markerwaard" dike"), 1956, (in Dutch).
- Delft Hydraulics Laboratory, Report M 544/1: "Golfoploop en Golfdrukken op dijktaluds. Overzicht modelonderzoekingen" ("Wave run-up and wave pressures on dike slopes. Summary of model investigations"), 1957 (in Dutch).

- Delft Hydraulics Laboratory, Report M544: "Golfoverslag bij dijken met ononderbroken glad talud" ("Wave overtopping on dikes with plane smooth slopes"), 1959 (in Dutch).
- Delft Hydraulics Laboratory, Report M 568: "Remmende invloed op golfoploop door ribbels op gesloten dijkbekleding" ("Reduction of wave run-up due to ribs on an impermeable dike facing"), 1957 (in Dutch).
- Delft Hydraulics Laboratory, Report M 815: "Invloed golfhoogteverdeling op golfoploop" ("Influence of wave height distribution on wave run-up"), written communication, 1966 (in Dutch).
- Delft Hydraulics Laboratory, Report M 872: "Golfaanval Afsluitdijk" ("Wave attack on barrier dam"), 1968 (in Dutch).
- Hosoi, M. and Mitsui, H.: "Wave run-up on sea dikes located in the surfzone or on the shore", Coastal Eng. in Japan, 6, p. 123-131, December 1963.
- Hundt, C.: "Der maßgebende Sturmflutseegang und Wellenauflauf für das Deichbestück der deutschen Nordseeküste auf Grund der Sturmflut von 16-2-1962", Die Küste, 10, 1969, no.2.
- Muraki, Y., Mori, K. and Minami, E.: "Field investigation of wave run-up and wave pressure on breakwater", Coastal Eng. in Japan, 6, p. 115-121, December 1963.
- Muraki, Y.: "Field observations of wave pressure, wave run-up and oscillations of breakwater", Proc. 10th Conf. Coastal Eng., Tokyo, Part I, p. 302-321, 1966.
- van Oorschot, J.H. and d'Angremond, K.: "The effect of wave energy spectra on wave run-up", Proc. 11th Conf. on Coastal Eng., London, Vol.I, p. 888-900, 1968.
- Rijkswaterstaat: "Verslag van de van 1947-1954 langs de Westerschelde verrichte golfwaarnemingen" ("Wave observations along the river Schelde, 1947-1954") R.W.S. Dir. Zeeland, Flushing, Report nr.55-7, 15 pages, June 1955 (in Dutch).

- Saville, T., Jr.: "An approximation of the wave run-up frequency distribution", Proc. 8th Conf. Coastal Eng., Mexico, p. 48-59, 1962.
- Sibul, O. and Tickner, E.G.: "A model study of the run-up of wind-generated waves on levees with slopes of 1:3 and 1:6", B.E.B., T.M.67, December 1955.
- Staatscommissie Lorentz: "Verslag Staatscommissie Zuiderzee" ("Report Zuiderzee Committee"), The Hague, 1926 (in Dutch).
- Wassing, F.: "Model investigations of wave run-up on dikes carried out in the Netherlands during the past twenty years", Proc. 6th Conf. on Coastal Eng., 1957, Part IV, p. 700-714.
- Webber, N.B. and Bullock, G.N.: "A model study of the distribution of run-up of wind-generated waves on sloping seawalls", Proc. 11th Conf. Coastal Eng., London, vol. I, p. 870-887, 1968.
- Wu, J.: "Wind-stress coefficients and scaling", von Karman Institute for Fluid Dynamics Lecture Series 19, Brussels, January 1970.

PART IV

WAVE OVERTOPPING

IV.1 INTRODUCTION

The structure of Part IV, dealing with wave overtopping, coincides largely with that of Parts II and III. An important difference lies in the fact that only one part is devoted to wave overtopping in which both regular and irregular waves are discussed. A division into two parts for the purpose of clarity did not seem necessary here because of the limited quantity of wave overtopping data.

IV.2 PARAMETERS

The independent parameters which determine the overtopping of waves coincide entirely with those for wave run-up referred to in chapters II.2 and III.2. It is desirable in this case to choose the crest height (h_d) of the dike above the mean water level as the characteristic length λ of the cross-section.

The dependent parameter is wave overtopping, which may be expressed quantitatively in a variety of ways. Often the discharge over the crest is determined per unit of width, averaged over time (\bar{q}). Sometimes also the overtopping volume per wave is considered.

By using parameter \bar{q} only, it is not possible to obtain anything more than a rough description of wave overtopping. The temporal variation of the instantaneous flow and of the velocities and layer thicknesses of the overtopping water will then not be considered. Little is known about these variables. This is due in part to the fact that they are difficult to measure. In view of this fact they will not be referred to below and only \bar{q} will be used as a measure of the overtopping. The expression $\bar{q}T_k/H_kL_k$ or $\bar{q}/\sqrt{gH_k^3}$ is often used as a dimensionless parameter for \bar{q} , so that by analogy with the results of the dimensional analysis in Chapters II.2 and III.2 the following expressions are obtained:

$$\frac{\bar{q}T_k}{H_kL_k} = f_1\left(\frac{H_k}{h_d}, \frac{H_k}{d}, \frac{H_k}{gT_k^2}, Re_k, We_k, \frac{\rho_t}{\rho_w}, \frac{\bar{w}_{10}^2}{gH_k}, \bar{\beta}, \bar{\varphi}_w, \text{ formfactors}\right) \quad (\text{IV.2.1})$$

or

$$\frac{\bar{q}}{\sqrt{gH_k^3}} = f_2\left(\frac{H_k}{h_d}, \text{etc} \dots\dots\dots\right) \quad (\text{IV.2.2})$$

Before presenting and discussing qualitative and quantitative experimental data on the influence of the dimensionless groups referred to above, the next chapter indicates work done in the non-experimental area.

IV.3 THEORIES

An analytical approach to the problem of overtopping of regular waves has been described by Kikkawa et al (1968). Shi-igai and Kono (1970) give an almost literal repetition of this work. They consider the flow pattern as a succession of different states of steady flow so that for the instantaneous discharge over the crest a weir-discharge formula may be used:

$$q = \frac{2}{3} m \sqrt{2g} (y - h_d)^{\frac{3}{2}} \quad (\text{IV.3.1})$$

in which y is the upstream energy level and h_d the crest height, both measured above the mean water level, and m is a discharge coefficient. The energy level y is written as:

$$y(t) = KH F(t) \quad (\text{IV.3.2})$$

in which H is a wave height and $F(t)$ a periodic function of time with period T and a maximum of 1, and K is a coefficient which may depend on the slope gradient and the wave steepness. Substitution in equation IV.3.1 and averaging gives

$$\bar{q} = \frac{2}{3} m \sqrt{2g} \frac{1}{T} \int_{t_0}^{t_1} \{ KH F(t) - h_d \}^{\frac{3}{2}} dt \quad (\text{IV.3.3})$$

in which t_0 and t_1 are the limits of the time interval for which $y(t) \geq h_d$. For an analytical determination of the integral, a piece-wise linear form function $F(t)$ is taken, as shown in figure IV.3.1:

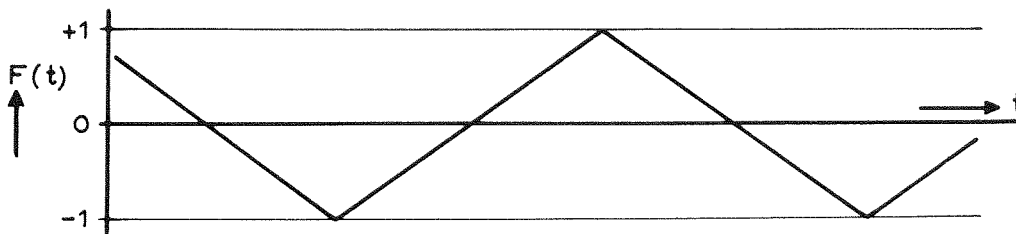

FIG. IV.3.1

Equation IV.3.3 then becomes

$$\frac{\bar{q}}{\sqrt{2gH^3}} = \frac{2}{15} m K^{\frac{3}{2}} \left(1 - \frac{h_d}{KH}\right)^{\frac{5}{2}} \quad (\text{IV.3.4})$$

Kikkawa et al choose the value of 0.5 for the discharge coefficient m . There then remains only one unknown coefficient K which may be calculated from measurements. For this purpose Kikkawa et al

use their own measurements and results published by Saville (1955) and Sibul and Tickner (1956). K shows little correlation with the wave steepness H/L_0 but a close correlation with the slope gradient α , as is apparent from figure IV.3.2.

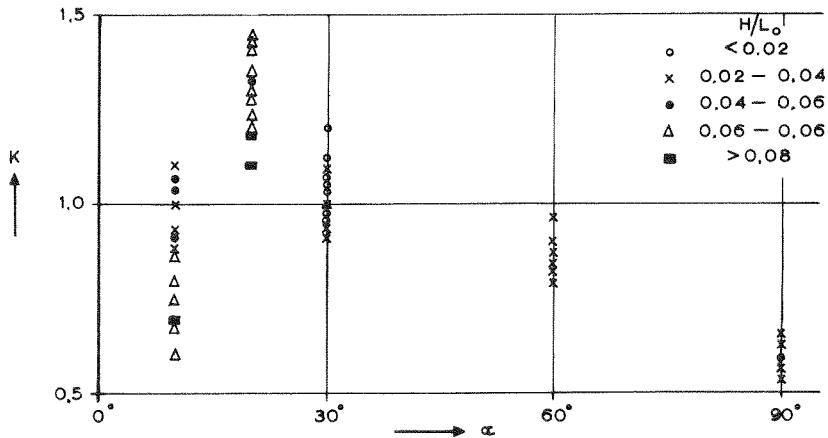

FIG. IV.3.2

K reaches a maximum value for $\alpha \approx 20^\circ$. Kikkawa et al relate this to the critical value of α at which the wave just breaks on the slope. Qualitatively, the influence of α on overtopping is therefore identical to that on run-up.

In figure IV.3.3, $\bar{q} / \sqrt{2gH^3}$ is plotted against h_d/H according to equation IV.3.4, for a number of K values. The measurement results are also given for four slopes. The trend of the measurement points coincides reasonably well with that of the calculated curves (K being chosen in such a way that the coincidence is optimal).

The simplifications introduced in the above derivation are fairly drastic. This is particularly true for the use of a discharge formula for permanent flows. It is therefore important for the relationships found to be tested against measurements before they can be considered usable.

The overtopping of irregular waves over vertical sea walls with or without stone covering at the base has been calculated by Tsuruta and Goda (1968) from the occurring or assumed wave height distribution on the one hand and from the relationship between \bar{q} and H known from measurements with regular waves on the other.

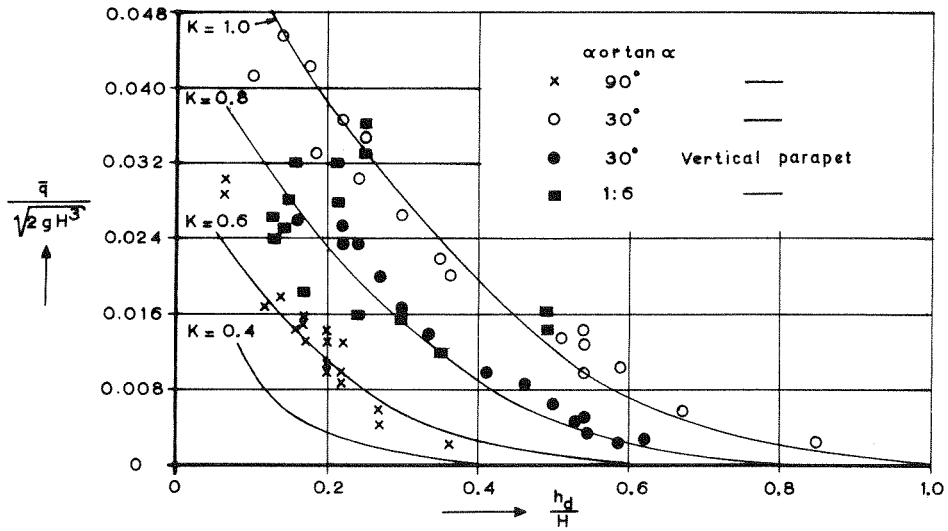

FIG. IV.3.3

Model experiments showed that overtopping per wave in an irregular wave train depended on H in much the same manner as in a regular wave train. The result of their calculations is shown in figures IV.3.4 and IV.3.5.

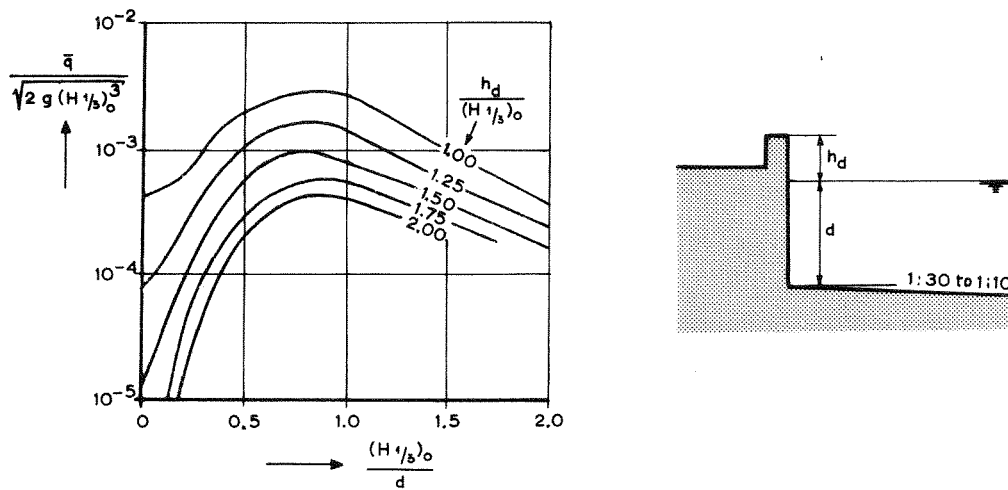

FIG. IV.3.4

For a number of cases without stone covering Tsuruta and Goda compared their calculations with model measurements. The calculated values of \bar{q} appeared to be approximately twice the measured values. Tsuruta and Goda accepted the difference as a safety factor.

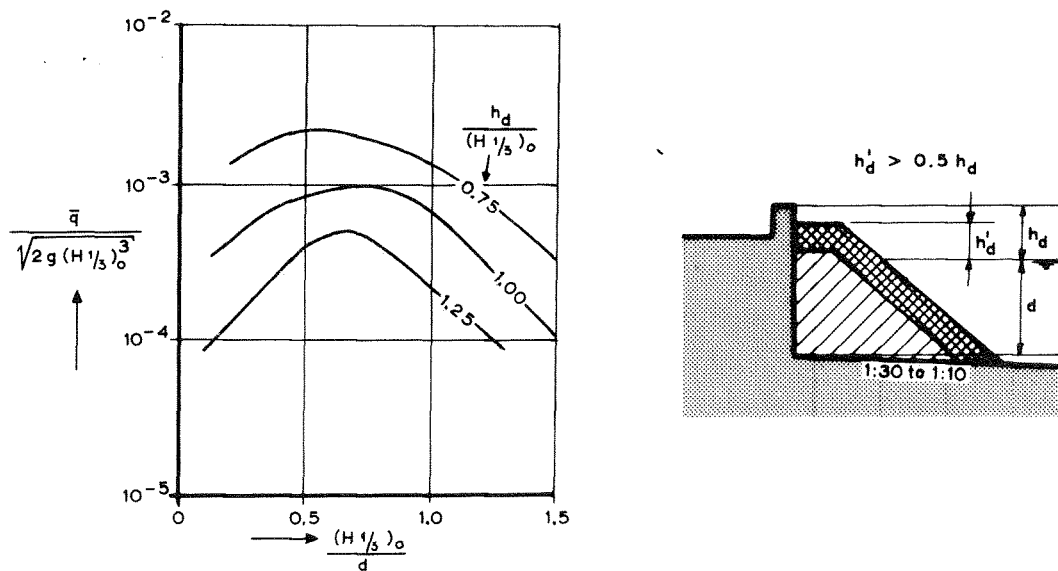

FIG. IV. 3.5

A calculation of the kind described above cannot be carried out for gentle slopes because too little data are available on the overtopping of regular waves on such slopes. There is also less need for this because the overtopping of irregular waves on gentle slopes has been measured in considerable detail (M 544, 1959; Paape, 1960). In this connection the following points may be noted.

Paape (1960) observed that there is no direct relationship between the dimensions of individual waves and the fact as to whether or not they overtop the crest. He considers the existence of a relationship of this kind as a condition for calculation of the total overtopping of irregular waves on the basis of data for regular waves. However, this condition is not necessary. Individual waves may give an overtopping which differs from that in regular waves, provided the differences cancel on average. This same concept was the basis of the methods indicated in chapter III.3 for calculating wave run-up distributions.

IV.4 QUALITATIVE EXPERIMENTAL RESULTS

IV.4.1 Introduction

Measurements of wave overtopping have been made primarily in Japan, the Netherlands and the United States. The relevant publications prior to 1960 are all American; in 1960 Paape published the results of a detailed series of tests in the Delft Hydraulics Laboratory; and the publications which have appeared since 1960 are almost all of Japanese origin. The Japanese and American measurements are generally concerned with overtopping over steep and often vertical walls. The Delft Hydraulics Laboratory used slope gradients of 1:8 to 1:2 for its measurements.

The influence of various independent parameters on wave overtopping is considered from the qualitative angle below. No explicit distinction is made between regular and irregular waves. Only plane smooth slopes are discussed with or without a sloping foreshore (1:10 or less). Qualitatively, the influence of various parameters on wave overtopping appeared altogether identical to that on wave run-up.

IV.4.2 Slope angle α

For waves breaking on a slope overtopping increases with α . The overtopping reaches a maximum value for the slope gradient at which the wave just ceases to break on the slope.

IV.4.3 Relative crest height h_d/H_k

Overtopping reduces when the crest is situated relatively higher above the mean water level.

IV.4.4 Angle of incidence

Overtopping of oblique waves has only been measured for $\beta_0 = 45^\circ$ and $\alpha = 90^\circ$ (Ishihara and co-workers, 1960). Overtopping was lower than with $\beta = 0^\circ$.

IV.4.5 Wave steepness H_k/gT_k^2

Japanese measurements on fairly steep slopes showed that $\bar{q}/\sqrt{gH_k^3}$ was practically independent on the wave steepness H_k/gT_k^2 or H_k/L_k . A number of American measurements showed that on slopes of

less than $1:3 \bar{q}/\sqrt{gH_k^3}$ diminished as H_k/gT_k^2 or H_k/L_k increased.

IV.4.6 Ratio H_k/d

Data on this ratio are known only for vertical walls with a sloping foreshore. Overtopping is maximum for H_k/d values at which the wave breaks just in front of the vertical wall (where d is defined as the depth at the wall).

IV.4.7 Reynolds number Re_k

No data.

IV.4.8 Weber number We_k

No data.

IV.4.9 Form of energy spectrum

No data.

IV.4.10 Wind velocity parameter w_{10}^{-2}/gH_k

Overtopping generally increases with wind velocity. For vertical walls the extent of the increase depends on whether the waves break in front or against the wall. For a vertical wall with its base at the mean water level a reduction in overtopping has been noted with an increase in wind velocity.

IV.4.11 Wind direction $\bar{\psi}_w$

No data.

IV.5 QUANTITATIVE EXPERIMENTAL RESULTS

IV.5.1 Introduction

A summary of all published laboratory measurements, known to the writers, of overtopping over dikes with plane, smooth slopes is given in table IV.5.1. In addition, some data are available on rough and non-plane slopes.

In compiling a summary of quantitative data for use in the Netherlands, it is desirable to give relatively much attention to measurements of overtopping of irregular waves over dikes in which the outer slopes have a gradient of less than 1:3. According to table IV.5.1 only the measurements by Sibul and Tickner (1956) and the Delft Hydraulics Laboratory (M 544, 1959, Paape, 1960) qualify.

IV.5.2 Field measurements

As far as is known, field measurements of wave overtopping have only been carried out in Japan. Shiraishi et al (1968) describe measurements at a wall with a gradient of 2:1 with a top-most section concave on the seaward side. The results as such are not considered here because of the incidental nature of the measurements. Similarly, no analysis is given of the results in order to investigate scale effects or the influence of wind for instance, because of the lack of comparative material. Shiraishi et al compare the field measurements with measurements in a model using regular waves. However, this procedure is not considered useful.

IV.5.3 Vertical seawall

As is apparent from table IV.5.1, a considerable proportion of the publications listed concern overtopping over a vertical seawall. The results are discussed briefly in this section. Use is made here of the study by Tsuruta and Goda (1968) who, as indicated in chapter IV.3, calculated the overtopping of irregular waves on the basis of data for regular waves. For this purpose they re-analyzed and re-grouped practically all the measurements published prior to 1968 on the overtopping of regular waves over a vertical seawall (Saville and Caldwell, 1953, Saville, 1955; Ishihara et al, 1960 and a number of Japanese publications which are not listed in this report). They worked on the basis of the following equation:

$$\frac{\bar{q}}{\sqrt{2gd^3}} = f\left(\frac{H_0}{d}, \frac{h_d}{d}, \frac{d}{L_0}, \tan \gamma\right) \quad (\text{IV.5.1})$$

MEASUREMENTS OF OVERTOPPING OVER DIKES WITH PLANE, SMOOTH SLOPES						
AUTHOR (S)	YEAR	NATURE OF WAVES		FORESHORE GRADIENT	SLOPE GRADIENT (α or $\tan \alpha$)	ANGLE OF INCIDENCE β_0
		REGULAR	IRREGULAR GENERATED BY:			
Saville and Caldwell	1953	X		1 : 10	90°	0°
Saville	1955	X		1 : 10	90° 1 : 1.5 1 : 3 1 : 6	0°
Sibul	1955	X		hor.	1 : 2 1 : 3	0°
Sibul + Tickner ; also contains data by : W.E.S. Vicksburg	1956		Wind	1 : 10	1 : 3 1 : 6	0°
		X		1 : 10	1 : 3 1 : 6	0°
H.L.-Delft M-544 Paape	1959 1960		Wind	hor.	1 : 2 1 : 3 1 : 3.5 1 : 4 1 : 5 1 : 6.5 1 : 8	0°
		X		hor.	1 : 5	0°
Ishihara et al	1960	X		1 : 10	90° 90° 60° 40° 30° 20°	45° 0°
Iwagaki et al	1966	X	Regular waves + wind	1 : 15	90°	0°
Tominaga et al	1966	X		1 : 30	1 : 1	0°
Shiraishi et al	1968	X		1 : 10	90°	0°
Tsuruta and Goda	1968	X	Wave machine (10 frequencies)	1 : 20	90°	0°
Kikkawa et al	1968				90°	
Shi-igai and Kono	1970	X		hor.	30°	0°

TABLE IV.5.1

in which d is the mean water depth immediately in front of the wall, H_0 the wave height on deep water and $\tan \gamma$ the gradient of the foreshore, which varied from 1:10 to 1:30. The result is shown in figure IV.5.1, in which $\bar{q} / \sqrt{2gd^3}$ is plotted against H_0/d with h_d/d as a parameter. Only the measurement points corresponding to $h_d/d \approx 1$ are shown in the figure. The corresponding values of the parameters d/L_0 and γ are not explicitly indicated.

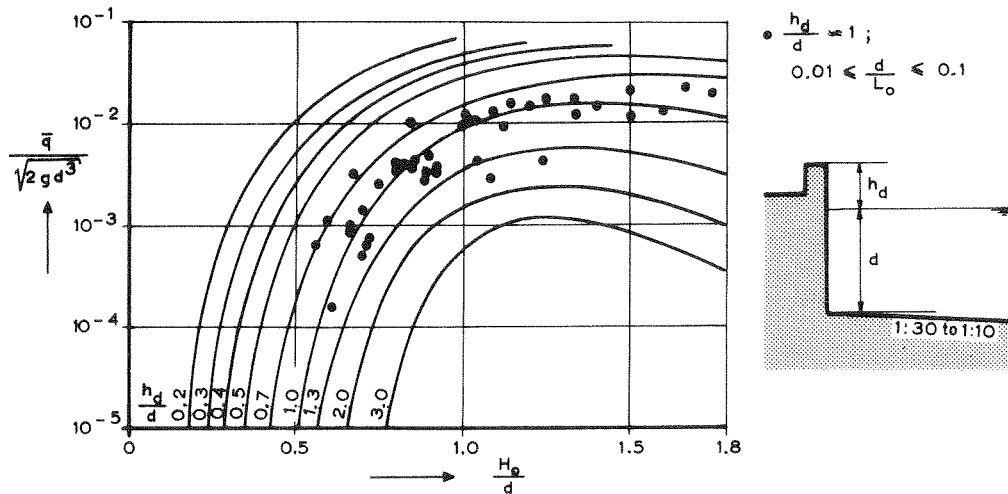

FIG. IV. 5.1

According to Tsuruta and Goda the influence of d/L_0 is insignificant provided that H_0/L_0 is greater than 0.01. The influence of the foreshore gradient was not perceptible. According to Tsuruta and Goda the lines of constant h_d/d , drawn through the centres of the respective point systems, give a good reflection of the trend of all measurements although in individual cases deviations are possible such that the points may be situated on adjacent curves.

Ishihara et al (1960) carried out measurements which they compared with those of Saville and Caldwell (1953) in order to investigate possible scale effects. They concluded that "the experimental results obtained by the authors (Ishihara et al) using comparatively small models are approximately in agreement with those for as large scale model as the shorestructure in the field by the Beach Erosion Board. This fact is considered to verify the validity of the dimensionless expression of the quantity of overtopping described previously".

The interpretation given by Ishihara et al is, however, based on a misconception. The measurements by Saville and Caldwell were in fact carried out on practically the same scale as those of Ishihara et al, but, "for convenience", Saville and Caldwell converted all their model measurements into equivalent prototype measurements on the basis of a 1:17 scale, and all the values are given in these prototype dimensions only. They indicate e.g. $d = 9$ ft and $h_d = 12$ ft as "structure test conditions". This is misleading because these dimensions are not valid for the test conditions.

The study by Ishihara et al is the only known attempt to study scale effects in the quantity of overtopping. The conclusion is therefore that no quantitative data are available on this aspect.

A comparison of the measurements by Ishihara et al with those of Saville and Caldwell can give an indication of reproducibility of the results. In an example quoted by Ishihara et al, deviations in overtopping occur corresponding to a factor 2. However, the trend in both series is exactly the same. The difference is less than in the results obtained by Iwagaki et al (1966) who repeated earlier tests made by themselves; deviations occurred corresponding to a factor 4.

The data referred to above all relate to regular waves. The overtopping of irregular waves over a vertical sea wall was measured by Tsuruta and Goda (1968). The movement of the wave generator was the sum of 10 sinusoidal components. The resulting energy spectrum of the waves represented to some extent a line spectrum. The measurements were carried out in the framework of the calculations referred to in chapter IV.3, page 152 and were intended to compare the overtopping of irregular waves with those of regular waves for a very limited number of cases and not to measure overtopping for a wide range of independent parameters. Only 8 measurements are reported. The result is summarized in table IV.5.2. The depth d was 35 cm and the gradient of the foreshore 1:20.

$H_{1/5}$ (cm)	\bar{T} (sec)	\bar{q} (cm ² /sec)	
		$h_d = 9.4$ cm	$h_d = 12.8$ cm
7.5	1.43	—	0
10.5	1.51	—	1.2
12.6	1.51	5.5	5.9
14.8	1.60	10.8	7.3
16.4	1.58	16.9	12.8

TABLE IV. 5.2

IV.5.4 Plane, smooth slope

The Delft Hydraulics Laboratory measured the overtopping of irregular waves over dikes with plane, smooth slopes and a horizontal foreshore (M 544, 1959; Paape, 1960). Seven slope gradients were applied, varying from 1:2 to 1:8 (see table IV.5.1). The waves were generated by wind in all cases. The average wind velocity \bar{w} was 8 m/sec or 10 m/sec in combination with all slope gradients. In addition a number of tests were carried out with $\bar{w} = 4$ m/sec and 6 m/sec for a slope gradient of 1:5. In practically all cases the depth was 0.30 m.

The dimensionless overtopping $2 \pi \bar{q} \bar{T} / H_{(50)} \tilde{L}$ is plotted in figure IV.5.2 against $h_d / H_{(50)}$ and in figure IV.5.3 against $h_d (\cot \alpha)^{3/2} / H_{(50)}$, with $\tan \alpha$ and the wave steepness $H_{(50)} / \tilde{L}$ as parameters. The value \bar{T} is the mean duration between two subsequent wave crests. No indication is given of the way in which the wave crests are defined. The wave length \tilde{L} is calculated from the depth d and the period \bar{T} on the basis of the conventional formula for periodic waves (equation II.5.5). Figure IV.5.2 also indicates the percentage of waves which overtopped. It is apparent that this percentage is almost exclusively a function of the dimensionless overtopping and not of wave steepness and slope gradient. Run-up formula III.5.13 was based on these data.

The measurement points in figure IV.5.3 all seem to fall within a fairly narrow range, with the exception of the points for $\tan \alpha = 1:2$, to which we shall return later (page 165). Overtopping diminishes in a more or less exponential manner with increasing crest height.

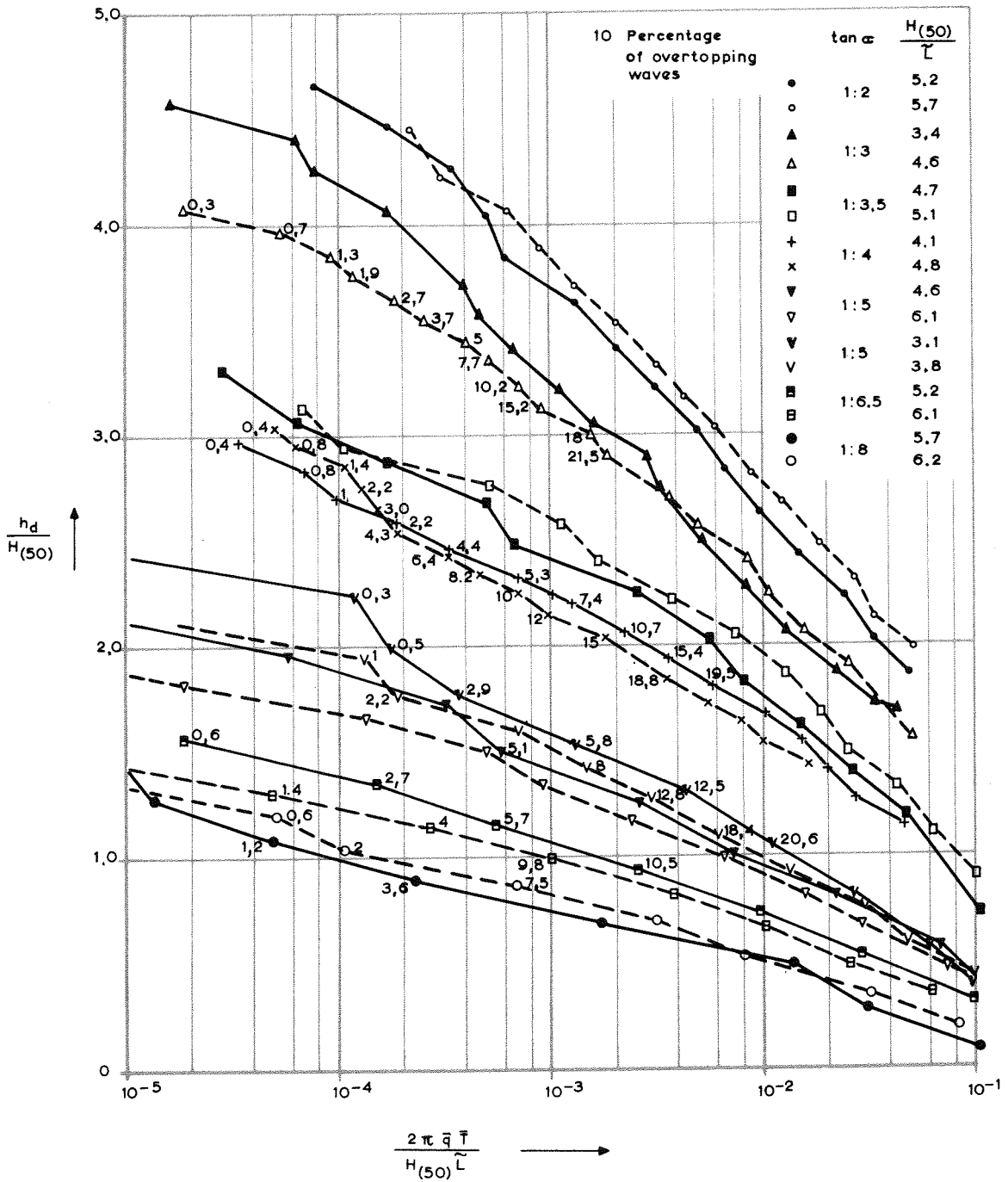

FIG. IV.5.2

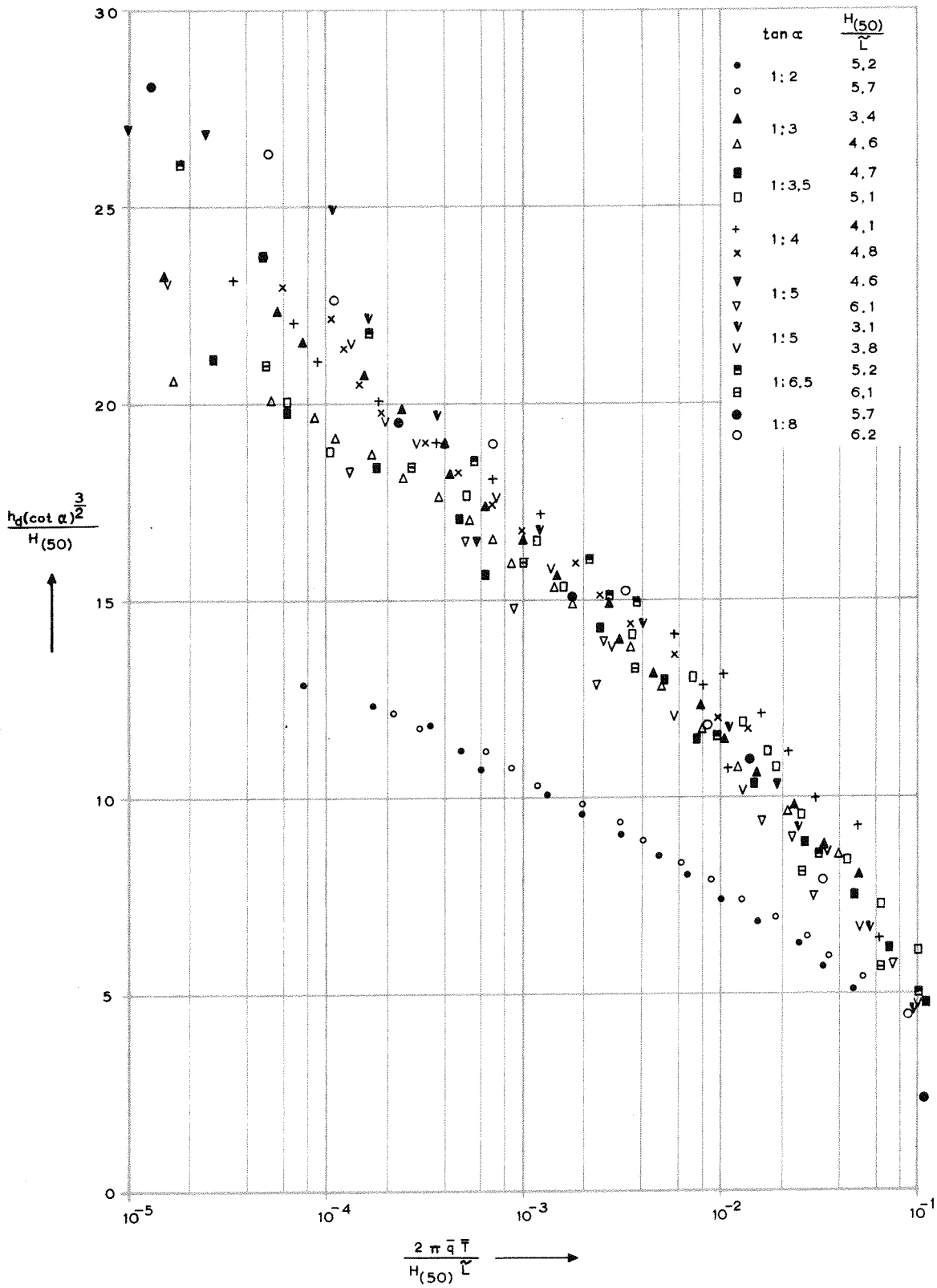

FIG. IV. 5.3

For a fixed $h_d (\cot \alpha)^{3/2} / H_{(50)}$ the dispersion in overtopping corresponds to a factor of 3 to 4. This is of the same order of magnitude as in the case of overtopping of irregular waves over a vertical seawall, in which all important parameters were considered. This suggests that this dispersion is the consequence of random factors. To the extent that this is in fact the case, it follows that there is no possibility of reducing the dispersion by choosing other parameters. Nevertheless an attempt can be made to obtain an equally good result by choosing simpler parameters, as described below.

The average volume of overtopping water per wave is $\bar{q}\bar{T}$ per unit of width. This factor is rendered dimensionless by dividing by the surface area of the wave above the average water level; for a sinusoidal wave with height H and length L this is $HL/2\pi$. This may also be interpreted as the volume (per unit of width) which is carried forward in a time interval of half a wave period throughout which the water level is above the mean level (Ishihara et al, 1960). In this way we obtain the dimensionless parameter $2\pi\bar{q}\bar{T}/H_{(50)}\tilde{L}$. This contains both \bar{T} and \tilde{L} , which are coupled through the depth. A simpler expression is obtained by not using \tilde{L} but \tilde{L}_0 defined by

$$\tilde{L}_0 = \frac{g\bar{T}^2}{2\pi} \quad (\text{IV.5.4})$$

In this case the overtopping parameters becomes

$$\frac{2\pi\bar{q}\bar{T}}{H_{(50)}\tilde{L}_0} = (2\pi)^2 \frac{\bar{q}}{gH_{(50)}\bar{T}} \quad (\text{IV.5.5})$$

which can be obtained from the original expression by multiplying by \tilde{L}/\tilde{L}_0 . This ratio was greater than 0.95 in all the cases reported in M 544, with one exception where the value corresponded to 0.90. Having regard to the dispersion of the results it may be concluded that on the basis of these experiments no preference can be given to \tilde{L} in place of \tilde{L}_0 . The opposite is perhaps also the case but \tilde{L}_0 should be given preference a priori because the period, and therefore \tilde{L}_0 , is always a characteristic parameter of the wave movement, also on the slope, while \tilde{L} is a local parameter which is only important at a certain depth.

In order to see the influence of the wave steepness $H_{(50)}/\tilde{L}_0$ on overtopping, the parameters $H_{(50)}$ and \tilde{L}_0 must not both occur in

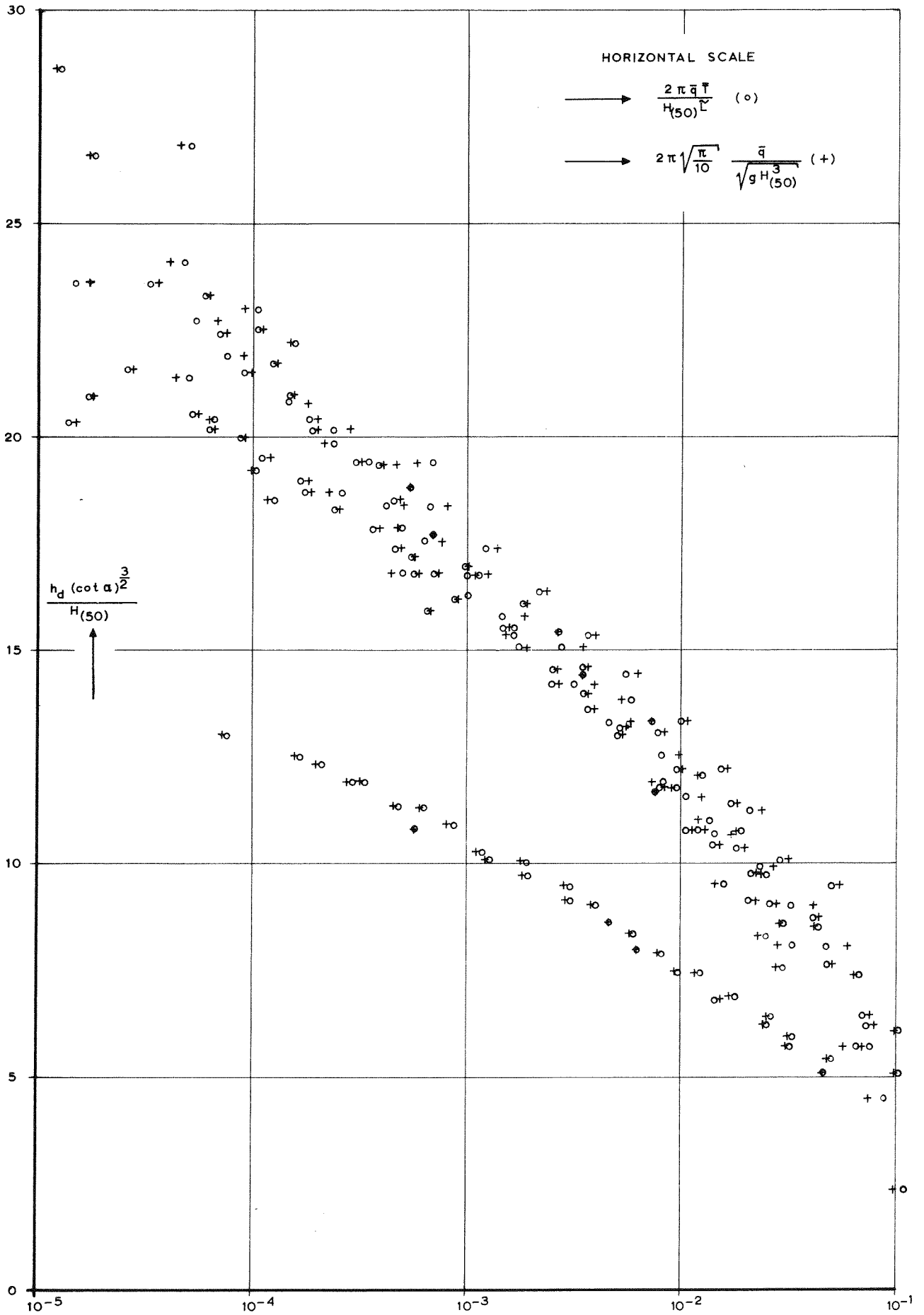

FIG. IV.5.4

the dimensionless overtopping. We have

$$(2\pi)^2 \frac{\bar{q}}{gH_{(50)}\bar{T}} = (2\pi)^2 \frac{\bar{q}}{\sqrt{gH_{(50)}^3}} \sqrt{\frac{H_{(50)}}{\bar{L}_o}} \quad (\text{IV.5.6})$$

and this parameter is almost solely dependent on $h_d (\cot \alpha)^{\frac{1}{2}} / H_{(50)}$ as follows from equation IV.5.5 and figure IV.5.3. From this it would appear that the dimensionless overtopping $\bar{q} / \sqrt{gH_{(50)}^3}$ is inversely proportional to $\sqrt{H_{(50)} / \bar{L}_o}$ (as is the dimensionless wave run-up $z/H_{(50)}$). However, this conclusion must be treated with some caution in view of the dispersion of the points in figure IV.5.3 and the fact that the wave steepness was varied by a factor of less than 2 only.

As an alternative treatment of the measured results, $\bar{q} / \sqrt{gH_{(50)}^3}$ is plotted in figure IV.5.4 against $h_d (\cot \alpha)^{\frac{1}{2}} / H_{(50)}$. All the points from figure IV.5.3 are also shown. The parameter $\bar{q} / \sqrt{gH_{(50)}^3}$ has been multiplied by a constant for easier comparison of the two systems of points. These show practically the same pattern. This means that no conclusion can be drawn from these experiments in regard to the influence of the wave steepness. However, on the basis of the relationship with the wave run-up, on which wave steepness certainly has an influence, it may be anticipated that this will also be the case for overtopping, in which case the parameter $\bar{q} / gH_{(50)}\bar{T}$ deserves preference over $\bar{q} / \sqrt{gH_{(50)}^3}$.

As already indicated (page 160), the measured points for $\tan \alpha = 1:2$ differ completely from the others. This difference is attributed in report M 544 to the fact that waves generally no longer break at this slope angle, but are reflected to a considerable extent. An estimate of the percentage of non-breaking waves may be made on the basis of the assumptions that the breaking criterion defined by Iribarren and Nogales (equation II.3.4) is applicable to the individual waves in an irregular wave train, that the steepness H/L_o is approximately Rayleigh-distributed, and that $H_{(50)} / \bar{L}_o = 0.05$ (figure IV.5.3). The results are given in figure IV.5.5 showing that between $\cot \alpha = 2$ and $\cot \alpha = 3$ there is a sudden transition in the percentage of non-breaking waves.

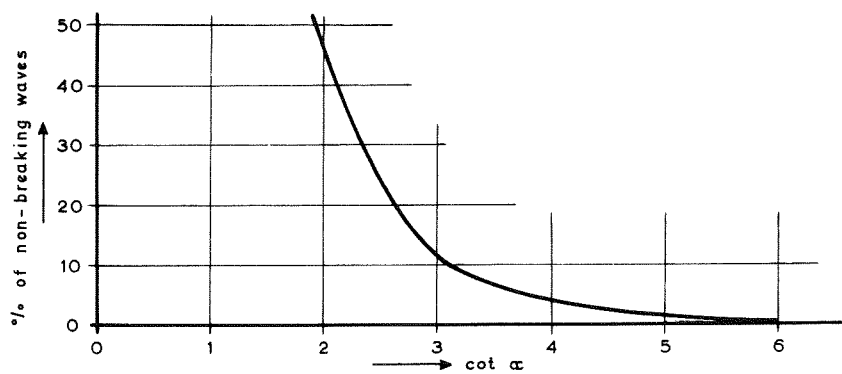

FIG. IV.5.5

This agrees with the model observations.

IV.5.5 Plane slope with roughness elements

Few measurements have been made of overtopping on artificially roughened plane slopes. A summary is given in table IV.5.3.

AUTHOR	YEAR	NATURE OF WAVES	tan α	TYPE OF ROUGHNESS
Sibul	1955	regular	1:2 1:3	laths
Saville	1955	regular	1:1.5	stepped slope
D.H.L. (M-657)	1963	irregular (wind)	1:3.5	stepped slope ribs blocks stakes

TABLE IV.5.3

The influence of roughness on wave overtopping is more complicated than that on wave run-up. In the latter instance only those situations are considered in which no overtopping occurs ($\bar{q} = 0$). The factor r , a quantitative measure of the effect of roughness on run-up, then seems dependent almost solely on the form of the roughness elements and their relative size. In the case of wave overtopping ($\bar{q} > 0$), r is, however, also dependent on the relative crest height or, in other words, on the relative overtopping which would occur in the presence of roughness. This can be most easily seen in the case of regular waves. When overtopping is reduced to zero by the provision of roughness elements, r becomes 0. For the same

roughness and a lower crest height overtopping may still occur, in which case $r > 0$.

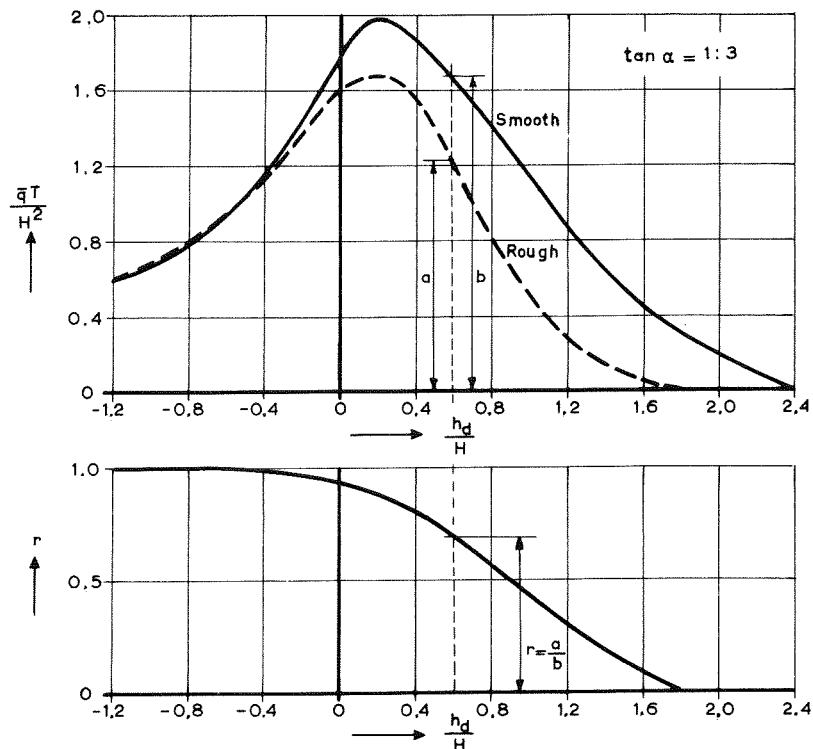

FIG. IV. 5.6

Figure IV.5.6 shows the results of a number of measurements made by Sibul where the crest height varied from high values where $r = 0$, to negative values, where $r \approx 1$. For the crest height at which the relative overtopping $\bar{q}T/H^2$ is maximum, the r value was 0.8 to 0.9. The roughness used by Sibul consisted of laths with the flat side secured to the slope and a thickness of 1/10 to 1/4 of the wave height.

In measurements carried out by the Delft Hydraulics Laboratory (M 657), in which the relative crest height was varied, r was between 0.45 and 0.25 for ribs and between 0.35 and 0.12 for stakes as the roughness elements.

The available data on the influence of roughness on wave overtopping are too limited for a quantitative generalization to be possible. Data on incidental cases are not fully reproduced here. This also applies to the parameters discussed in the following sections. Generally reference is only made to measurements which were

carried out without considering the results.

IV.5.6 Rough and permeable slope

Saville (1955) measured overtopping of regular waves on a plane slope with a gradient of $1:1\frac{1}{2}$ covered with rubble. Shiraishi et al examined the influence of a tetrapod system in front of a vertical seawall. Tsuruta and Goda (1968) did the same for different types of concrete blocks, the shape of which was not specified in detail. Their analysis was based on 8 reports (in Japanese) by various authors. The results for regular waves is shown in figure IV.5.7. The gradient of the covering is not indicated but was probably approx. $1:1\frac{1}{2}$.

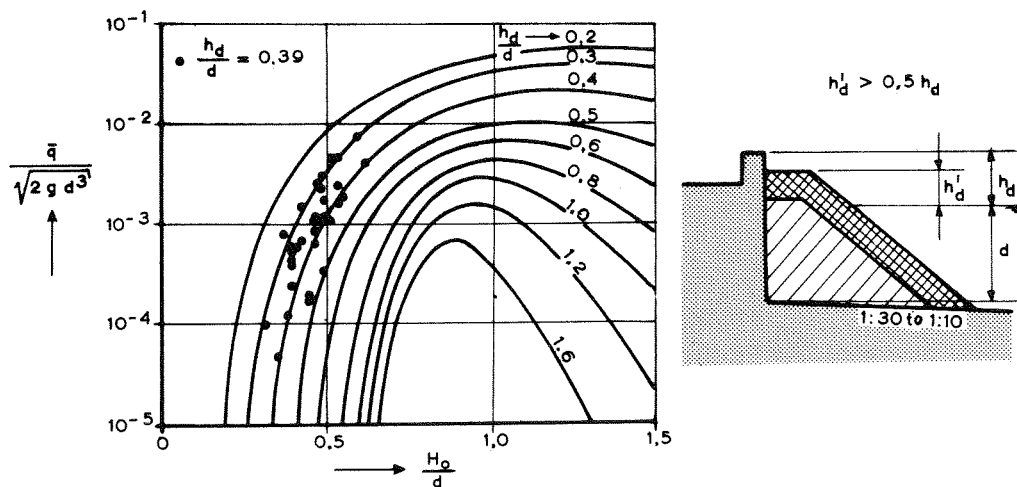

FIG. IV.5.7

IV.5.7 Non-plane, smooth slope

Saville (1955), Merckens (1964) and Tominaga et al (1966) measured overtopping over seawalls of various shapes, generally with a gradient in excess of $1:1$ and a concave surface towards the sea. Saville also gives results for a composite slope with a gradient of $1:3$ below the mean water level and $1:6$ above, and for a slope with a gradient of $1:3$ and a berm at the mean water level. Model reports published by the Delft Hydraulics Laboratory also indicate data for wave overtopping over dikes with different cross sections, sometimes including a berm (M 657). This shows

that a berm gives the greatest reduction in overtopping when it is situated approximately at mean water level or just above. Overtopping generally diminishes exponentially with increasing crest height, as in the case of plane slopes.

IV.5.8 Oblique incidence

Data on the overtopping of oblique waves have been published by Ishihara et al (1960) for a vertical seawall and a foreshore gradient of 1:10. The angle of incidence was 45° in deep water and 20° to 40° at the wall itself. The overtopping is reduced more than in proportion to the factor $(1 - \cos \beta)$, even when the influence of refraction on the wave height is taken into account.

IV.5.9 Wind influence

The overtopping of regular waves over a dike with a slope gradient of 1:3 or 1:6 has been compared by Sibul and Tickner (1956) with that of waves generated in a fairly small flume by a wind of exaggerated velocity. Sibul and Tickner considered the measurements to be qualitative. In the model, wind begins to exert a significant influence on overtopping at $\bar{w} \approx 5$ m/sec with $\tan \alpha = 1:6$ and at $\bar{w} = 10$ m/sec with $\tan \alpha = 1:3$. Qualitatively this agrees with the observations in section III.5.8, showing that the wind has a greater influence on wave run-up the lower the slope gradient.

Iwagaki et al (1966) investigated the influence of wind on overtopping over a vertical seawall with a foreshore gradient of 1:15. For this purpose they directed wind over initially regular waves. The results therefore not only reflect the influence of wind on overtopping of a given wave train but also on the wave train itself. With increasing wind velocity overtopping appeared to increase considerably when the waves did not break and only slightly when the waves broke before reaching the wall. If the point at which the foreshore reaches the wall is situated above the mean water level, the overtopping even appears to reduce with increasing wind speed.

IV.6 REFERENCES

- Delft Hydraulics Laboratory, Report M 544: "Golfoverslag bij dijken met ononderbroken glad talud" ("Wave overtopping on dikes with plane smooth slopes"), September 1959 (in Dutch).
- Delft Hydraulics Laboratory, Report M 657: "Golfoverslag Afsluitdijk" ("Wave overtopping on barrier dam"), 1963 (in Dutch).
- Ishihara, T., Iwagaki, Y. and Mitsui, H.: "Wave overtopping on seawalls", Coastal Eng. in Japan, 3, p. 53-62, 1960.
- Iwagaki, Y., Shima, A. and Inoue, M.: "Effects of Wave Height and Sea Water Level on Wave Overtopping and Wave Run-Up", Coastal Eng. in Japan, 8, p. 141-151, 1965.
- Iwagaki, Y., Tsuchiya, Y. and Inoue, M.: "On the effect of wind on wave overtopping on vertical seawalls", Bull. Dis. Prev. Res. Inst., Kyoto Univ., 16, no.104, part 1, pp.11-30, September 1966.
- Kikkawa, H., Shi-igai, H. and Kono, T.: "Fundamental Study of wave-overtopping on levees", Coastal Eng. in Japan, 11, p.107-115, 1968.
- Merkens, P.W.: "Overtopping of wind waves of a sea wall, as affected by waterdepth", Shore and Beach, 32, no.2, p. 27-30, October 1964.
- Paape, A.: "Experimental data on the overtopping of seawalls by waves", Proc. 7th Conf. Coastal Eng., The Hague, vol.2, p. 674-681, 1960.
- Saville, T. and Caldwell, J.M.: "Experimental study of wave overtopping on shore structures", Proc. IAHR, Minnasota, Minneapolis, p. 261-269, 1953.
- Saville, T.: "Laboratory data on wave run-up and overtopping on shore structures", B.E.B. Techn.Mem.no.64., 32 pages, 1955.
- Shi-igai, H. and Kono, T.: "Analytical approach on wave overtopping on levees", Proc. 12th Conf. Coastal Eng., Washington, D.C. vol.I, p. 563-573, 1970.

- Shiraishi, N., Numata, A. and Endo, T.: "On the effect of armour block facing on the quantity of wave overtopping", Proc. 11th Conf. Coastal Eng., London, vol.II, p. 853-869, 1968.
- Sibul, O.: "Flow over reefs and structures by wave action", Trans. A.G.U., 36, no.1, p. 61-71, 1955.
- Sibul, O.J. and Tickner, E.G.: "Model study of overtopping of wind-generated waves on levees with slopes of 1:3 and 1:6", B.E.B., Techn. Mem. no. 80, 27 pages, 1956.
- Tominaga, Y., Hashimoto, H. and Sakuma, N.: "Wave run-up and overtopping on coastal dikes", Proc. 10th Conf. Coastal Eng., Tokyo, vol.I, p. 364-381, 1966.
- Tsuruta, S. and Goda, Y.: "Expected overtopping discharge of irregular waves over sea wall", Proc. 11th Conf. Coastal Eng., London, vol.II, p. 833-852, 1968.

LIST OF SYMBOLS

Symbol	Description	Dimension
a	distance from waterline to lower limit of roughened area (positive upward)	L
b	width of roughened area, measured in a vertical plane normal to the slope	L
b_m	smallest value of b for which the run-up does not exceed the roughened area	L
B	width of berm	L
c	phase velocity	LT^{-1}
C	coefficient of Chézy	$L^{\frac{1}{2}}T^{-1}$
d	waterdepth	L
d_b	breaker depth	L
d_B	depth of berm below mean water level	L
D	absolute roughness	L
F(t)	shape function (eq.IV.3.2)	-
g	gravitational acceleration	LT^{-2}
h	water level above a reference level	L
h_d	height of dike crest above mean water level	L
h_d'	height of a rubble protection above mean water level	L
h_d^*	value of h_d for which 2% of the waves overtop the crest	L
H	wave height (between zero-crossings)	L
$H_{(50)}$	value exceeded by 50% of the wave heights	L

Symbol	Description	Dimension
$H_{\frac{1}{3}}$	mean value of the highest one-third of the wave heights	L
H_m	root-mean-square wave height	L
k	height of roughness elements	L
k_s	Nikuradse-roughness	L
K_s	shoaling coefficient	-
K_1	modified Bessel function of the third kind of first order	-
l	distance between adjacent roughness elements	L
L	wave length	L
\tilde{L}	theoretical length of a periodic wave with period \bar{T}	L
m	discharge coefficient	-
m	wave number ($= \frac{2\pi}{L}$)	L^{-1}
n	ratio of group velocity to phase velocity	-
n	Manning coefficient	$L^{\frac{1}{6}}$
n	subscript: exceedance percentage (100P)	-
O	fictitious run-up height above dike crest	L
P	probability of exceedance	-
q	instantaneous overtopping discharge per unit width	$L^2 T^{-1}$
r	ratio of run-up reduced by some means to run-up without reduction; the same definition applies to overtopping	-

Symbol	Description	Dimension
r_m	value of r in the case of a roughened slope where the run-up does not reach beyond the roughened area	-
R	distance between two points	L
Re	Reynolds number	-
s	stagnation pressure of wind, expressed in cm water column	L
t	time	T
T	wave period	T
\hat{T}	period of spectral component with maximum energy density	T
U	particle velocity in run-up bore if this bore is at the still water line	LT^{-1}
\bar{w}_{10}	mean wind velocity at a height of 10 m above MWL	LT^{-1}
We	Weber number	-
x	height of water level above design level	L
y	determining thickness of water running up the slope	L
y	energy level	L
z	run-up height: maximum height above MWL reached by a wave which runs up against a slope	L
z'	normalised run-up (eq. III.3.1)	-
z_B	value of z on a slope with a berm of width B	L

Symbol	Description	Dimension
z_s	design run-up height on smooth slope	L
z_r	design run-up height on roughened slope	L
α	slope angle of dike or seawall with respect to horizontal	-
α_{cr}	critical value of α for which a given incident wave train is in the transition of breaking and non-breaking	-
β	angle of incidence: acute angle between wave propagation direction and the normal to the depth contours	-
γ	slope angle of foreshore with respect to horizontal	-
δ	correction factor in formula for run-up of non-breaking waves (eq. III.3.11)	-
Δ	relative super-elevation of a wave crest caused by non-linear effects	-
ϵ	measure of the relative width of energy spectrum	-
λ	characteristic length of cross-sectional profile	L
μ	dynamic viscosity of water	$ML^{-1}T^{-1}$
ξ	exponent in formula for run-up of solitary waves	-
ρ	coefficient of linear correlation of H and T^2	-
ρ_a	mass density of air	ML^{-3}
ρ_w	mass density of water	ML^{-3}

Symbol	Description	Dimension
σ	surface tension at air-water interface	MT^{-2}
ϕ_w	wind direction with respect to some reference direction	-

An overbar denotes an average value.

A subscript "o" refers to deep water.

A subscript "k" means "characteristic value".