

Wireless Pick and Place Library Management Robot

Urvesh Katode
Viva Institute of
Technology
Shirgaon, Virar (E)

Prathamesh
Mandavkar
Viva Institute of
Technology
Shirgaon, Virar (E)

Jai Kudu
Viva Institute of
Technology
Shirgaon, Virar (E)

Sayali Lad
Viva Institute of
Technology
Shirgaon, Virar (E)

ABSTRACT

A Library Management robot is device to help any libraries which are still using the old way to manage their library. The old way like searching for a book using manual work is hassle, fast report generation is not possible, information about issue/return of the books are not properly maintained, as information about the issued book is not available so database cannot be created . But by using this, user can overcome all the problems mentioned above. This system can manage all the happenings of the library.

Keywords

Line Follower, Book, Robotic Arm, Microcontroller, Robot

1. INTRODUCTION

A library is a collection of books; it provide service to members. There is a need of librarian to pick the book and handover it to the person. This might be easy task in case the library is small. Also, to search for the books by humans take a lot of time as many a times the books gets overlooked the human eye. Solution to this problem is a robot which will help to find out the book with the required tag and then pick it and place it on the table.

1.1 Features

- **Line follower robot:** This robot is movable machine that can sense and follow the line drawn on the floor. Detecting a line and steering the robot to stay on path, while continuously correcting wrong moves using feedback mechanism forms closed loop system.
- **PC control:** PC is used to select required book using database and give command to robot to pick that particular book. The command to the robot is wireless. A person have to give command only once from pc then further procedure will be automated.
- **Wireless - CC2500:** This wireless module is used to make communication between the robot and computer wirelessly. It is half duplex module hence only pc or robot can send or receive data at the time.
- **Pick books from different pre-defined location and place it on common (pre-defined) location:** The above work is done by the automated and preprogrammed robotic arm for picking and placing and to bring that book at predefined position is done by line follower mechanism.
- **Single (active) RFID Tx - for book identity:** Here RFID (Active) transmitter and receiver is used for book identification. This circuit uses the RF module which is used to drive an output from a distant place. RF module uses radio frequency to send signals. At particular

frequency and baud-rate, these signals are transmitted (book side). A receiver (robot side) receives these signals only if it is configured for that frequency.

- **Database on PC side – VB:** For the selection of book from the pc side is possible only if there is information is stored related to the books. For that Virtual base database is used.
- **8051 Controller and DC motor:** AT89S52 is a high-performance, low power CMOS 8 bit microcontroller with 8Kb of programmable Flash memory in the system. It process data transmitting from the pc side and send commands to the robot.

2. METHEDOLOGY

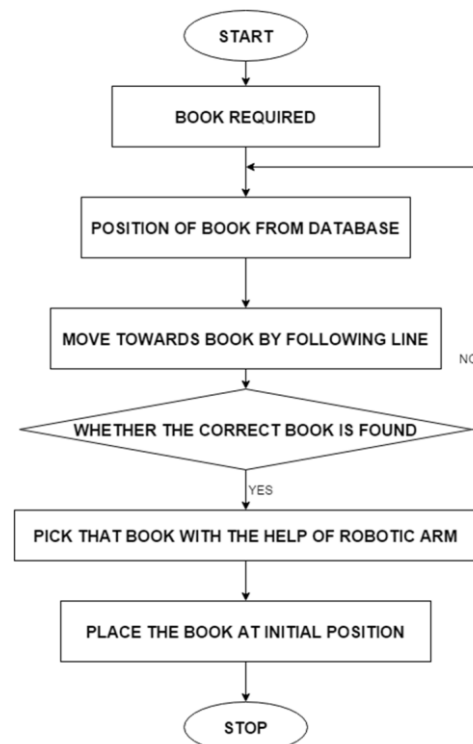

Fig. 1: General Flow of Working

The base houses the entire arm with development board and RFID decoder. For forward and reverse, left and right movement, a motor is fitted under the base of robot.

Here user will be placing the books in a rack and all the books will be tagged by RFID encoder. The robot will perform a brute force method search and in case the book is found, robotic arm will lower and when the RFID gets matched with

desired book, the robotic arm will close jaws to get a hold of the book.

The arm is designed so that the books which it picks should not fall down. And then robotic arm is activated after which the robot moves in the reverse direction to the place it started from and places the book.

Suppose someone wants to select particular book then user have to give specific number which was tagged on the book .Then it will be transmit from user to robot via Tx and Rx module of serial communication. Once the microcontroller got that number then robot start following the line. At that same time controller start the RFID module and start the obstacle (book) detection. Image identification and verification is done using active RFID encoder decoder. Position of book is fetched from server. If book is detected then it will proceed for the verification. If detected book is not required one then robot starts line following. And if the detected book is correct then controller starts the arm part. Arm will pick that book. After picking the book from the rack robot will return to the initial position which was given and place the book.

3. BLOCK DIAGRAM

3.1 Robot Side

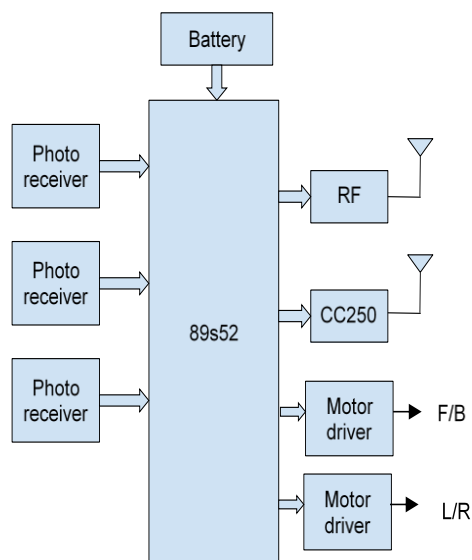

Fig. 2: Block Diagram of Robot Side

3.1.1 Microcontroller (AT89S52):

The device is well-suited with the industry standard 80C51 instruction set and pin out. The inbuilt Flash memory permits the program memory to be reprogrammed by conventional nonvolatile memory programmer.

The AT89S52 make available standard features: 8Kb of Flash-memory, 256 B of Random Access Memory, 32 Input/Output lines, three 16-bit timer/counters, a six vector two level interrupts, full duplex serial port, on-chip oscillator, and clock circuit. The Idle Mode halts the CPU while permitting the Volatile Memory, timer/counters, serial port, and interrupts to continue working. RAM contents are saved when microcontroller is in power down mode, but halts the oscillator, deactivating all chip activities until the next interrupt or hardware reset.

3.1.2 Day Light Sensor:

L14G2 is NPN photo-transistor. It acts as a photo detector in the sense that it converts the incident light into electric response. They are used as sensors typically combined with a light source like LED.

These are bipolar transistors having a transparent cover. This cover exposes the BC region of transistor to outside light. When light fall on junction, electrons are produced by the photons. Electrons are injected in base of phototransistor. Current gain of transistor amplifies the resultant photocurrent at the B-C junction. Thus phototransistor is in ON mode in the presence of light and remains in OFF mode in absence of light. Maximum dark current is 100nA; while in light its current is 500µA.

A phototransistor is different from a conventional BJT, voltage applied to base is interchanged by light striking on it. A phototransistor amplifies differences in the light striking on it.

If a base terminal is available, light response is biased by it.

Photodiodes and phototransistors have similar functionalities except they have lower gain and lower photocurrent. Phototransistor does not detect low intensities of light but responsive to exposed light. Also, the transistor response lasts for a longer period as compared to a photodiode.

The essential light source is a GaAs LED with peak wavelength is 940 Nano-Meter. Emitter lead is specified by a protruding edge in the transistor cover. Base is closest to emitter. Collector is at the other extreme side of casing.

3.1.3 Motor Driver:

Motors require more current then microcontroller pin, switch is needed (Transistors, MOSFET, Relay etc..) which can take small current, amplify it and generate a larger current, which further drives a motor. This complete process is carried out by a motor driver.

L293D allows DC motor to drive on either direction. This is 16-pin IC can control two DC motors at same time in any direction. The L293D drives small and big motors.

3.1.4 DC motor:

In any electric motor, operation is based on electromagnetism. Current-carrying conductor creates a magnetic field; when this is then placed in an exterior magnetic field, it will experience force proportional to current in conductor, and to strength of external magnetic field. Internal configuration of a DC motor is planned to connect magnetic interaction between a current-carrying conductor and external magnetic field to make rotations.

3.1.5 Robotic Arm:

Mobile robots are repeatedly organized in serious conditions that are risky for humans to handle as part of industrial operations, anti-terror measures or law enforcement, e.g. to recognize a doubtful object or defuse a bomb. Owing to extreme situations, these manipulator vehicles have to meet specific requirements. Exact steering and accurate handling of tools are two vital fundamentals. Devices also should be kept small in order to allow access through narrow passageways. Drivers used for robots have to be impressive. Special high performance micro motors have become an essential component.

3.2 Book Side

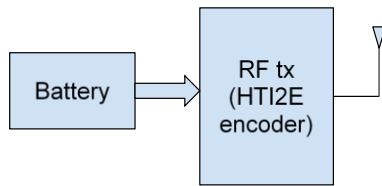

Fig. 3: Block Diagram of Book Side

3.2.1 RF Transmitter Receiver:

This small sized RF module set is used in robots and home automation applications. RF Rx-Tx pair permits wireless control of robots at a range of more than 200 meters.

The external antenna for Receiver and Transmitter are not included. There are holes on these modules, in which external antenna can be connected. Without antennas user can send and receive data, but this restricts the range. Putting an antenna on either the RX or TX will further extend the range. The tiny copper wire (spiral) on the unit is an inductor, not an antenna.

3.3 Pc Side

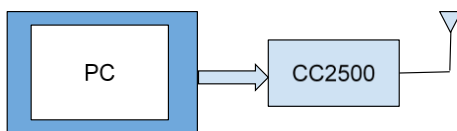

Fig. 4: Block Diagram of PC Side

3.3.1 CC2500:

CC2500 is FSK /MSK Transceiver module. It provides hardware support for data buffering, channel assessment, packet handling and wake on radio, data transmissions. Data can be Manchester-coded by modulator and decoded by demodulator. It has high performance and easy to design the product. It is used in Wireless game controllers, 2400-2483.5 MHz ISM/SRD band systems, Consumer Electronics, Wireless audio wireless Virtual Key Board/Mouse and wireless systems.

The Module's frequency, Sensitivity, Output power can be programmed.

3.3.2 USB to TTL:

Cable is simplest way to connect to Raspberry Pi/ microcontroller/ router port. Inside big USB plug there is USB to Serial conversion chip and at the end of 36 inch cable are four wires – red for power, black for ground, white for RX in USB port, and green for TX out of USB port.

4. ADVANTAGES

1. System excludes the use of paper work by managing all the book information electronically.
2. Admin can update database by providing new books in library and their availability thus students need not to go to library for issuing purpose.
3. System has books well organized and analytically arranged in different categories in the system so that user can easily search and find the book.

4. Thus, it saves human efforts and resources.

5. CONCLUSION

Misplacing of the books can be identified easily. It reduces the manual work. With the proposed architecture, if constructed with at most accuracy, the robot will pick the book. If such a system is developed, it will act as a basic platform for the generation of more such devices for the book picking.

6. FUTURE SCOPE

Line following robot based materials supply system can play an important role in field of hospitality. Line following robot's application over electronics engineering can't be underestimated.

This is used in driver less car system with some added features like obstacle detection.

It is used in industrial automated equipment carriers, Entertainment and small household applications, automated cars, Tour guides in galleries and other similar applications, reconnaissance operations.

7. RESULTS

7.1 Identification and Arm Movement

Input from PC	RFID switch value	Robotic arm movement	Buzzer output
Station A	1000	Match found- ON	OFF
		Match not found- OFF	ON
Station B	0100	Match found- ON	OFF
		Match not found- OFF	ON
Station C	0010	Match found- ON	OFF
		Match not found- OFF	ON
Station D	0001	Match found- ON	OFF
		Match not found- OFF	ON

In result 1, we have 4 columns which states that when input is given from pc side for example: Station B, the robot will start moving towards station B by following the line. At station B, if RFID tag has the value 0100, which matches with the robot side RFID then Robotic arm will turn ON & it will pick the book. But if the RFID value does not match then Buzzer will turn ON giving a notification to user & Robot will return to its initial position.

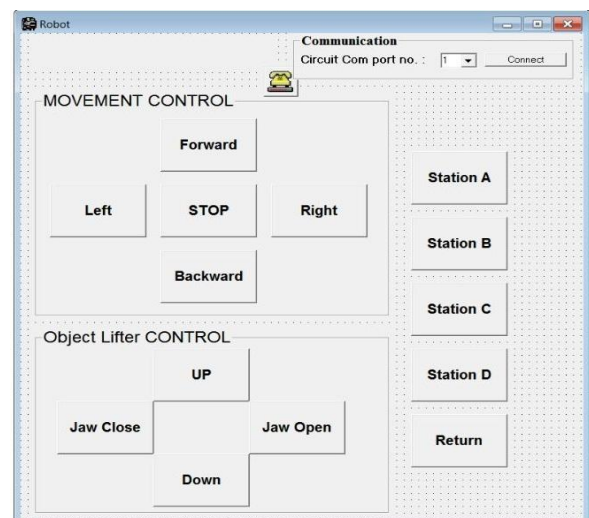

7.2 Robot Movement

Robotic Movement	Codes	Counter
Forward	101	-
Right	100	-
Left	001	-
Special Condition	000	Count1-Station A or B
		Count2-Station C or D

Result 2 states the results of movement of robot by following the line. With the help of Sensors the robot receives the values 101-for forward motion, 100-for taking right turn, 001 – for left turn, 000-for counting, that is, for moving towards Station A or B if count is 1 **OR** moving towards Station C or D if the count is 2.

7.3 Functioning of Robot

Step 1: The robot will be at the initial Position before giving the command.

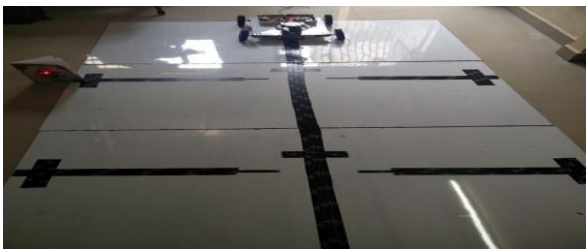

Step 2: After giving command, robot will follow the line.



Step 3: According to the user input (Stations), the robot will go to the respective station and it will pick the book if RFID is matched. But, if the RFID does not match then the buzzer will be activated indicating that this book is incorrect and it will return to initial position.



Step 4: After picking the book from respective station, the robot will bring the book to the user.

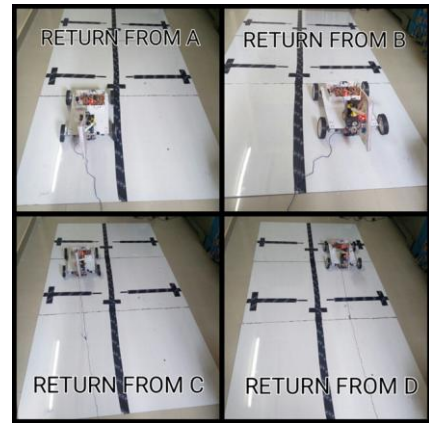

8. ACKNOWLEDGMENTS

Our thanks to the faculty and principal for giving this opportunity to express our work.

9. REFERENCES

- [1] Bong Keun Kim, Nobuyasu Tomokuni, Kenichi Ohara, Kohtaro Ohba, Tamio Tanikawa, and Shigeoki Hirai Ubiquitous function services based control of robots with ambient intelligence. In Proc. 2006 IEEE Int. Conf. On Industrial Electronics, Control, and Instrumentation, pages 4546–4551, 2006a.
- [2] Dias, B.; Zlot, R.; Kalra, N.; and Stentz, A. 2006. Marketbased multirobot coordination: A survey and analysis. Proceedings of the IEEE 94 (7): 1257–1270.
- [3] Noriaki Ando, Takashi Suehiro, Kosei Kitagaki, Tetsuo Kotoku, and Woo-Keun Yoon. RT-middleware: Distributed component middleware for RT (robot Technology). In Proc. 2005 IEEE/RSJ Int. Conf. Intelligent Robots and Systems, pages 3555–3560, 2005.
- [4] H. Chae, J. Lee, and W. Yu. A localization sensor suite for development of robotic location sensing network. In Proc. 2nd Int. Conf. Ubiquitous Robots and Ambient Intelligence, pages 188–191, 2005.
- [5] A.P. del Pobil, M. Prats, R. Ramos-Garijo, P.J. Sanz, and E. Cervera. The UJI librarian robot: an autonomous service application. In Proc. 2005 IEEE Int. Conf. Robot. Automat., 2005.
- [6] Bong Keun Kim, Manabu Miyazaki, Kohtaro Ohba, Shigeoki Hirai, and Kazuo Tanie. Web services based robot control platform for ubiquitous functions. In Proc. 2005 IEEE Int. Conf. Robot. Automat., pages 703–708, 2005.
- [7] Browning, B.; Bruce, J.; Bowling, M.; and Veloso, M. 2005. STP: Skills, tactics and plays for multi-robot control in adversarial environments. IEEE Journal of Control and Systems Engineering 219:33–52.
- [8] Guo, Y., and Parker, L. E. 2002. A distributed and optimal motion planning approach for multiple mobile robots. In Proceedings of IEEE International Conference on Robotics and Automation.
- [9] Kobby Appiah-Berko, Andrew Dykhuis, Tyler Helmus, Nnamdi Maduagwu, "The Librarian- A Library Book Indexing Robot", May 9, 2012, ENGR 340, Calvin College
- [10] Muhammed Jabir.N.K, Neetha John, Muhammed Fayas, Midhun Mohan, Mithun Sajeev, Safwan.C.N, "Wireless

Control of Pick and Place Robotic Arm Using an Android Application”, *International Journal of Advanced Research in Electrical, Electronics and Instrumentation Engineering* Vol. 4, Issue 4, April 2015

[11] Wan Muhamad Hanif Wan Kadir, Reza Ezuan Samin, Babul Salam Kader Ibrahim, “Internet Controlled Robotic Arm”, *International Symposium on Robotics*

and Intelligent Sensors 2012 (IRIS 2012) *Procedia Engineering* 41 (2012) 1065 – 1071

[12] Mohd Ashiq Kamaril Yusoff, Reza Ezuan Samin, Babul Salam Kader Ibrahim, “Wireless Mobile Robotic Arm”, *International Symposium on Robotics and Intelligent Sensors 2012 (IRIS 2012) Procedia Engineering* 41 (2012) 1072 – 1078